

# Workshop on Computer Hardware and Network

---

## DCAP105

Edited by:  
Dr. Avinash Bhagat



---

**L** OVELY  
**P** ROFESSIONAL  
**U** NIVERSITY

---



# **WORKSHOP ON COMPUTER HARDWARE AND NETWORK**

Edited By  
Dr. Avinash Bhagat

Printed by  
**EXCEL BOOKS PRIVATE LIMITED**  
A-45, Naraina, Phase-I,  
New Delhi-110028  
for  
Lovely Professional University  
Phagwara

## SYLLABUS

### Workshop on Computer Hardware and Network

*Objectives:* To impart the skills needed to assemble a PC, PC troubleshooting, installation of system/application software. Student can prepare cables for LAN, assign IP's to machines.

Sr. No.	Topics
1.	Introduction of Hardware and Software/components of computer.
2.	Mother boards, Chipsets & Microprocessor concept & latest available in market. Basics & types of Floppy drive/HDD/DVD/RAM /SMPS/ /BIOS etc
3.	Handling & Holding sensitive equipments, Installing Motherboards, Choosing Cabinet & Cooling considerations, Installing CPU.
4.	Assembling of different parts of computers.
5.	Knowing ports, wires attached in the pc. Knowing SATA slots, IDE Slots
6.	CMOS. Setting BIOS configurations.
7.	Installation of OS (Linux/Windows) and application/utility software, Handling Viruses
8.	Networking Basics: Different Wires, Hubs, Connectors. Punching/Crimping Tools. Switches, I/O Sockets
9.	Creation of Cross Wires and Direct Cables.
10.	IP & Setting up a computer on LAN

# CONTENT

<b>Unit 1:</b>	Introduction to Hardware and Software <i>Avinash Bhagat, Lovely Professional University</i>	1
<b>Unit 2:</b>	CPU Components <i>Avinash Bhagat, Lovely Professional University</i>	26
<b>Unit 3:</b>	Assembling of Different Parts of Computers <i>Avinash Bhagat, Lovely Professional University</i>	46
<b>Unit 4:</b>	Working with Ports and Wires <i>Avinash Bhagat, Lovely Professional University</i>	69
<b>Unit 5:</b>	BIOS and CMOS <i>Avinash Bhagat, Lovely Professional University</i>	83
<b>Unit 6:</b>	Installation of OS and Handling Viruses <i>Mithilesh Kumar Dubey, Lovely Professional University</i>	100
<b>Unit 7:</b>	Networking Basics <i>Mithilesh Kumar Dubey, Lovely Professional University</i>	135
<b>Unit 8;</b>	IP & Setting up a Computer on LAN <i>Mithilesh Kumar Dubey, Lovely Professional University</i>	162



## Unit 1: Introduction to Hardware and Software

Notes

### CONTENTS

Objectives

Introduction

- 1.1 Computer Hardware
  - 1.1.1 Central Processing Unit
  - 1.1.2 Input Devices
  - 1.1.3 Output Devices
  - 1.1.4 Storage Devices
- 1.2 Network System
  - 1.2.1 Types of Networks
- 1.3 Computer Software
  - 1.3.1 System Software
  - 1.3.2 Application Software
- 1.4 Summary
- 1.5 Keywords
- 1.6 Review Questions
- 1.7 Further Readings

### Objectives

After studying this unit, you will be able to:

- Explain the concept of Computer Hardware
- Discuss the Input and Output Devices
- Describe network system
- Explain the concept of Computer Software

### Introduction

A computer is a combination of two terms Hardware and Software. The physical components of a computer are called hardware. Pieces of hardware may be categorized according to the functions each performs: input, process, output, and storage. Your PC (Personal Computer) is a system, consisting of many components. Some of those components, like Windows XP, and all your other programs, are software. Software is the source of interaction between the user and the computer. It represents programs, collection of several sets of instructions, which allow the hardware to run properly. The stuff you can actually see and touch, and would likely break if you threw it out a fifth-story window, is hardware.

### 1.1 Computer Hardware

Hardware of a computer is made up of complex electronic circuits. For a user the details of the circuitry are not important. However, the hardware units with which a user has to interact must

**Notes**

be clearly understood. For convenience, the hardware of a computer can be classified in the following categories:

1. Input Devices
2. Output Devices
3. Central Processing Unit (CPU)
4. Memory or Storage
5. Motherboard

Let us discuss each of these hardware components:

1. **Input Devices:** The form in which data is available to a user is not always in the same form as is accepted by computer hardware. Input devices are hardware equipment that receive data and instructions from users, convert the data and instructions into a form that can be processed by the computer and passes the same to the computer. Hence, if you have to enter employees' names into the computer you do not have to write it on a piece of paper and shove the paper inside the computer. You will need some input device for this.



*Example:* A keyboard is an example of input device.

2. **Output Devices:** The result, produced by a computer after processing, is not always in user readable form. An output device is hardware equipment that translates this non-readable result into a form understood by the users.



*Example:* A VDU (Visual Display Unit) or monitor is an example of output device.

3. **Central Processing Unit (CPU):** Central processing unit is to computer what brain is to our body. It is the master organ of a computer. No computer can exist without a CPU. It is composed of two simpler hardware units - Arithmetic Logic Unit (ALU) and Control Unit (CU). CU controls all the activities of other hardware units while ALU performs all the calculations. Computer CPUs are very fast in their calculations and swift in control.
4. **Memory or Storage:** This hardware is the place where a computer stores all the data and instructions given to it. The results of the processing are also stored here. A computer has many types of memories. Some memories are directly connected to the CPU and are extremely fast as far as storage and retrieval of data is concerned. These memories are called primary memory - RAM (Random Access Memories) and ROM (Read Only Memories) belong to this category of memories. The CPU takes data and instructions stored only in the primary memories.



*Notes* **Primary memories** are also of various types. The one that loses its contents when power is switched off is known as volatile memory such as RAM. Some memories retain the data and instructions stored on them even after the power is switched off such as ROM. These memories are known as non-volatile memories.

**Secondary storage devices** are placed outside the system unit and can be carried from one system to another allowing portability of data and instructions. Floppy disks or diskettes, hard disks and CD-ROM are some of the secondary storage devices. Input devices, output devices and secondary storage devices are not directly connected to the CPU and hence are known as peripheral devices or simply peripherals.



5. **Motherboard:** Motherboard, also called as System Board, is the most important hardware component of a microcomputer. Motherboard is so called as all the other boards (printed circuit boards having chips or other electronic components) of the computer are connected to this board, hence it is like the mother of all other boards.

Now we will discuss the components of computer hardware in detail.

### 1.1.1 Central Processing Unit

*Central Processing Unit (CPU)* is the main component or “brain” of a computer, which performs all the processing of input data. Its function is to fetch, examine and then execute the instructions stored in the main memory of a computer. In microcomputers, the CPU is built on a single chip or Integrated Circuit (IC) and is called as a *Microprocessor*. The part of a computer (a microprocessor chip) that does most of the data processing, the CPU and the memory form the central part of a computer to which the peripherals are attached. The Central Processing Unit (CPU) is the part of a computer that interprets and carries out the instructions contained in the software.

The CPU consists of the following distinct parts:

- **Arithmetic Logic Unit (ALU):** The arithmetic and logic unit of CPU is responsible for all arithmetic operations like addition, subtraction, multiplication and division as well as logical operations such as less than, equal to and greater than. Actually, all calculations and comparisons are performed in the arithmetic logic unit.
- **Control Unit (CU):** The control unit is responsible for controlling the transfer of data and instructions among other units of a computer. It is considered as the “Central Nervous System” of computer, as it manages and coordinates all the units of the computer. It obtains the instructions from the memory, interprets them and directs the operation of the computer. It also performs the physical data transfer between memory and the peripheral device.
- **Registers:** Registers are small high speed circuits (memory locations) which are used to store data, instructions and memory addresses (memory location numbers), when ALU performs arithmetic and logical operations. Registers can store one word of data (1 word = 2 bytes & 1 byte = 8 bits.) until it is overwritten by another word. Depending on the processor’s capability, the number and type of registers vary from one CPU to another. Registers can be divided into six categories viz. General Purpose Registers, Pointer Registers, Segment Registers, Index Registers, Flags Register and Instruction Pointer Register, depending upon their functions. The detailed functions of each and every register is beyond the scope of this book.
- **Bus:** Data is stored as a unit of eight bits (BIT stands for Binary Digit i.e. 0 or 1) in a register. Each bit is transferred from one register to another by means of a separate wire. This group of eight wires, which is used as a common way to transfer data between registers is known as a *bus*. In general terms, bus is a connection between two components to transmit signal between them. Bus can be of three major types viz. Data Bus, Control Bus and Address Bus. The data bus is used to move data, address bus to move address or memory location and control bus to send control signals between various components of a computer.
- **Clock:** Clock is another important component of CPU, which measures and allocates a fixed time slot for processing each and every micro-operation (smallest functional operation). In simple terms, CPU is allocated one or more clock cycles to complete a micro-operation. CPU executes the instructions in synchronization with the clock pulse.

Notes

The clock speed of CPU is measured in terms of *Mega Hertz (MHz)* or Millions of Cycles per second. The clock speed of CPU varies from one model to another in the range 4.77 MHz (in 8088 processor) to 266 MHz (in Pentium II). CPU speed is also specified in terms of *Millions of Instructions Per Second (MIPS)* or *Million of Floating Point Operations Per Second (MFLOPS)*.

The relation between various hardware components of a computer system is depicted in the figure 1.1:

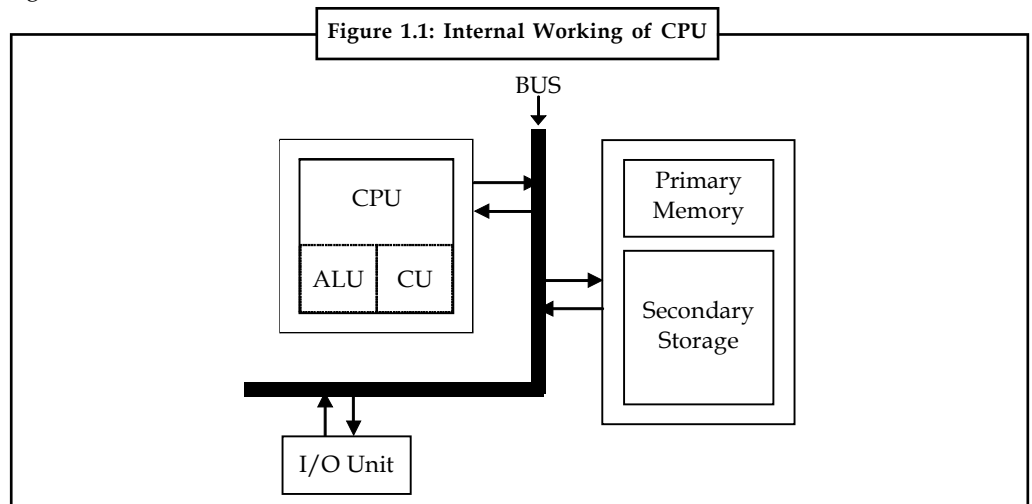

 *Task* Compare and contrast Arithmetic Logic Unit (ALU) and Control Unit.

### 1.1.2 Input Devices

Input devices are used to input data, information and instructions into the RAM. These are “stand-alone” data entry stations. These units usually have a small processor attached to a keyboard and a visual display unit. The processor checks for the accuracy of data at the time of entry.

The common input devices are mentioned below.

#### Keyboard

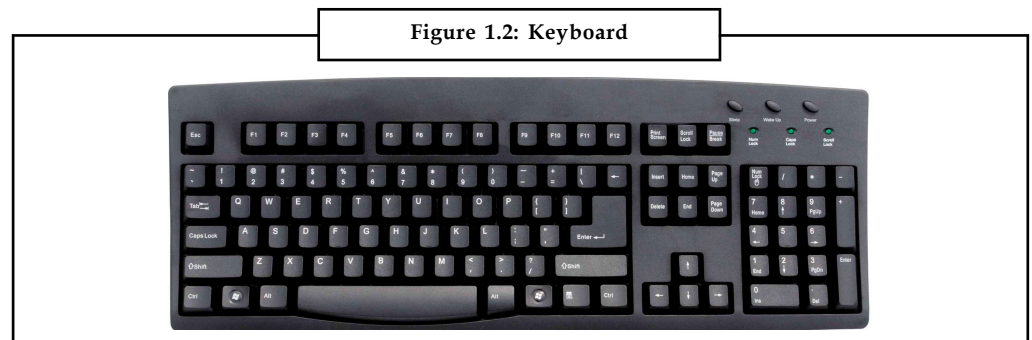

The keyboard is one of the most common input devices of computers. The layout of the keyboard is like that of the traditional QWERTY typewriter. Most keyboards have three sections of keys: the standard typing keys, cursor movement keys and the numeric keypad. To help users enter

numbers quickly, keyboard provides a numeric keypad that functions much like a 10-key calculator. To select the numeric keypad's operation, we need to use the Num Lock key. Most PCs come with a standard keyboard, which is flat in appearance. Keyboard's keys match with that of a typewriter. The keyboard also includes special purpose function keys, arrow and cursor control keys. The layout of a simple keyboard can be seen in the Figure 1.2.

## Mouse

While working with a display we are mostly pointing to some area in the display to select an option and move across on the screen to select subsequent options. Mouse is a handy device which can be moved on a smooth surface to simulate the movement of cursor that is desired on the display screen. An optical mouse offers quiet and reliable operation. But a mechanical mouse is much cheap.

Figure 1.3: Mouse

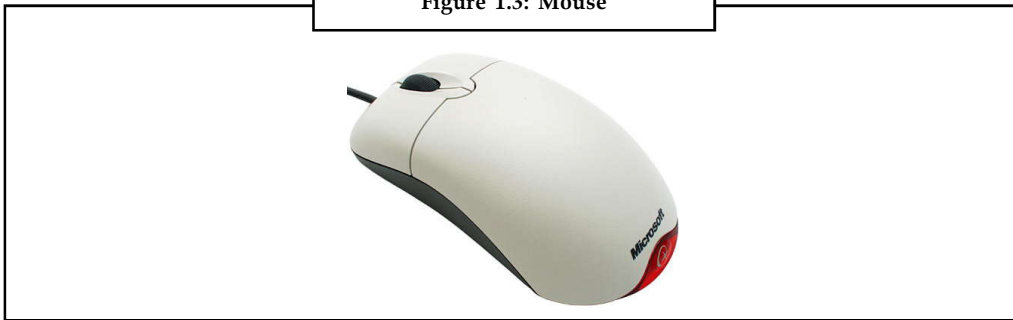

Within Windows, user will make extensive use of mouse operations, which he/she refers to as "point and click operations." To point the mouse, simply aim the mouse pointer that appears on the screen at the object of desire. To move mouse pointer across the screen, simply move the mouse across the desk. To click mouse, press and release the mouse-select button (normally the left-mouse button). Many operations within Windows require that double-click mouse by pressing and releasing the mouse-select button two times in quick succession. For notebook PCs, touch pad, track ball or other pointer devices are also available. They are assisted with additional keys for clicking. To reduce the strain on wrist there is pad, which elevates the wrist while using the keyboard or mouse.

## Trackball

A trackball looks like a mouse, as the roller is on the top with selection buttons on the side. It is also a pointing device used to move the cursor and works like a mouse. For moving the cursor in a particular direction, the user spins the ball in that direction. It is sometimes considered better than mouse, because it requires little arm movement and less desktop space. It is generally used with portable computers.

Figure 1.4: Trackball



Notes

**Light Pen**

Light pen is a pointing device, which is used to select a displayed menu item or draw pictures on the monitor screen. It's a pen shaped device allowing natural movement on the screen. The pen contains the light receptor and is activated by pressing the pen against the display screen. Receptor is the scanning beam which helps in locating the pen's position. Suitable system software is provided to initiate necessary action when we locate an area on the display surface with the help of the light pen. It consists of a photocell and an optical system placed in a small tube. When its tip is moved over the monitor screen and the pen button is pressed, its photocell-sensing element detects the screen location and sends the corresponding signal to the CPU.

Figure 1.5: Light Pen



**Touch Screen**

Touch screen is sensitive to human fingers. Using this device, the user can point to a selection on the screen instead of pressing keys.

Figure 1.6: Touch Screen



**Game Controller**

A game controller is a device used with games or entertainment system used to control a playable character or object, or otherwise provide input in a computer game. A controller is typically connected to a game console or computer by means of a wire, cord or nowadays, by means of wireless connection. Controllers which have been classified as games controllers are keyboards, mice, game pads, joysticks, etc.

Figure 1.7: A Game Controller



### Optical Bar Code Reader (OBR)

It can scan a set of vertical bars of different widths for specific data and is used to read tags and merchandise in stores, medical records, library books, etc.

### Image Scanner

Scanner is mainly used in Desktop Publishing applications. Scanner is used for digitizing images such as photographs, forms, documents, etc., in computer memory. Some scanners can also read text by converting them to digital code. These scanners are very useful for converting the typed pages into word-processing files.



*Did u know?* Graphics scanners convert a printed image in video image without converting it to digital code.

### Optical Character Reader (OCR)

It is also an optical scanner, which is capable of detecting alphanumeric characters typed or printed on paper using an OCR font. OCR devices are used for large volume applications like reading of passenger tickets; computer printed bills of credit card companies and reading of ZIP codes in postal services. The text, which is to be scanned, is illuminated by a low-frequency light source. The dark areas on the text absorb the light while light areas reflect it. The photocells of OCR device receive this reflected light and provide binary data corresponding to dark and light areas.

### Microphone

Sometimes abbreviated as mic, a microphone is a hardware peripheral that allows computer users to input audio into their computers.

Figure 1.8: Microphone

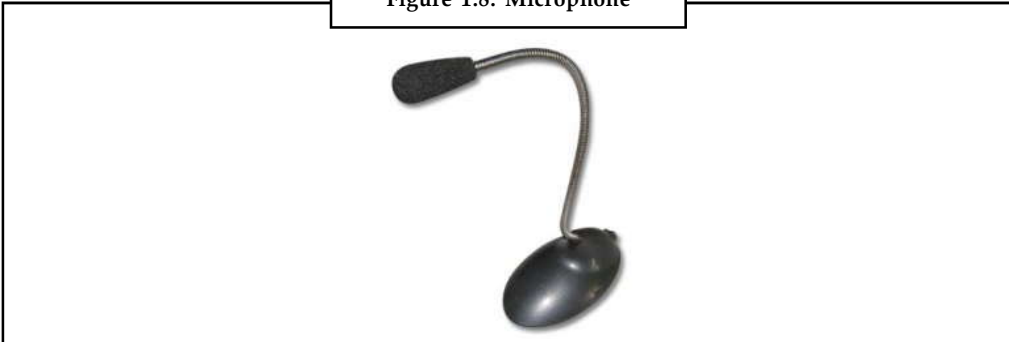

**Notes**

**Voice-input Devices**

These devices can recognize the human voice. Voice recognition techniques, along with several other techniques to convert the voice signals to appropriate words and desire the correct meaning of words, are comprehensive speech recognition system. Today devices are available to recognize and interpret human voices within a limited scope of operation. They seem to be very useful but are not popular due to storage of limited vocabularies and variations in the way of pronouncing words by different persons.

**Digital Camera**

A type of camera that stores the pictures or video it takes in electronic format instead of to film. There are several features that make digital cameras a popular choice when compared to film cameras. First, the feature often enjoyed the most is the LCD display on the digital camera. This display allows users to view photos or video after the picture or video has been taken, which means if you take a picture and don't like the results, you can delete it; or if you do like the picture, you can easily show it to other people. Another nice feature with digital cameras is the ability to take dozens, sometimes hundreds of different pictures.

**1.1.3 Output Devices**

Once data are processed, output devices translate the language of bits into a form humans can understand. Output devices are divided into two basic categories: those that produce hard copy, including printers and plotters; and those that produce soft (digital) copy, including monitors (the most commonly used output devices. The output normally can be produced in two ways - either on a display unit/device or on a paper. Other kinds of output as speech output, is also being used in certain applications.

Let us now discuss various output devices:

**Monitors**

Visual Display Unit (VDU), commonly called as monitor is the main output device of a computer. It consists of a Cathode Ray Tube (CRT), which displays characters as an output. It forms images from tiny dots, called pixels that are arranged in a rectangular form. The sharpness of the image (screen resolution) depends upon the number of pixels.

There are different kinds of monitors depending upon the number of pixels. Depending upon the resolution, monitors can be classified as follows:

- (a) CGA (Colour Graphics Adapter)
- (b) MDA (Monochrome Display Adapter)
- (c) HGA (Hercules Graphics Adapter)
- (d) EGA (Enhanced Graphics Adapter)
- (e) VGA (Video Graphics Adapter)
- (f) SVGA (Super VGA)

The differences between these monitors are summarised in Table 1.1. Depending upon the colour of display, monitors can be classified as Monochrome (with single colour black/white display) and Colour (with all colours display) Monitors. The pictures of two different models of color monitors are shown in Figure 1.9.

Figure 1.9: Two Models of Color Monitors

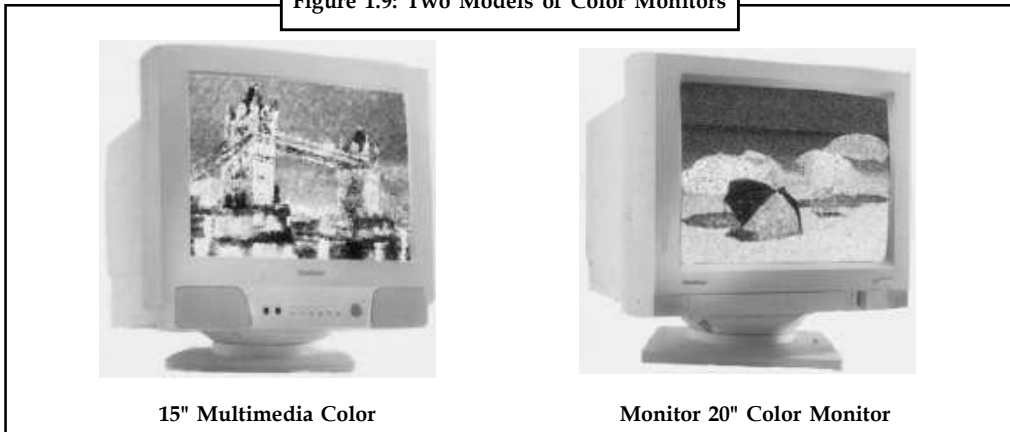

Table 1.1: Comparison among Different Types of Monitors

Type of Monitor	Display Type	Text Resolution	Graphics Resolution (Pixels)
CGA	Text & Graphics	Fair quality	320 × 200
MDA	Text only	Good quality	-
HGA	Text & Mono Graphics	Fair quality	320 × 200
EGA	Text & Enhanced Graphics	Good quality	640 × 350
VGA	Text & Video Graphics	Much better than all	640 × 480
SVGA	Text & Video Graphics	Best quality	1600 × 1280

### Video Controller

Also known as a graphics card, video card, video board, or a video controller, a video adapter is an internal circuit board that allows a display device, such as a monitor, to display images from the computer.

### PC Projector

Figure 1.10: PC Projector

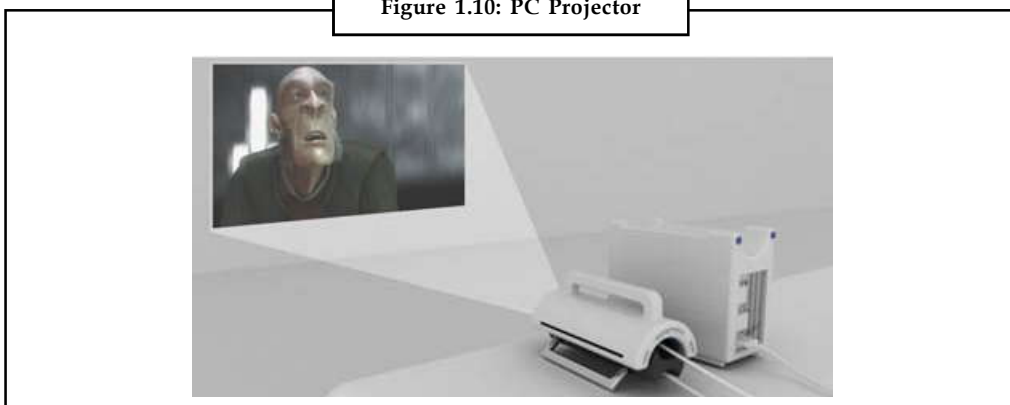

A projector is a device that uses light and lenses to take an image and project a magnified image onto a larger screen or wall. Projectors can magnify still or moving images depending on how they are built.

**Notes**



*Caution* The image must be shone through a sealed tube or frame when passing through the lenses to maintain focus.

**Speakers**

A hardware device connected to a computer's sound card that outputs sounds generated by the card.

**Figure 1.11 : Speaker**



**Printer**

Printers are used for producing output on paper. There are a large variety of printing devices which can be classified according to the print quality and the printing speed.

**Figure 1.12: Printer**



There are many types of printers, which are classified based on various criteria as illustrated in Figure 1.13.

**Figure 1.13: Various Types of Printers**

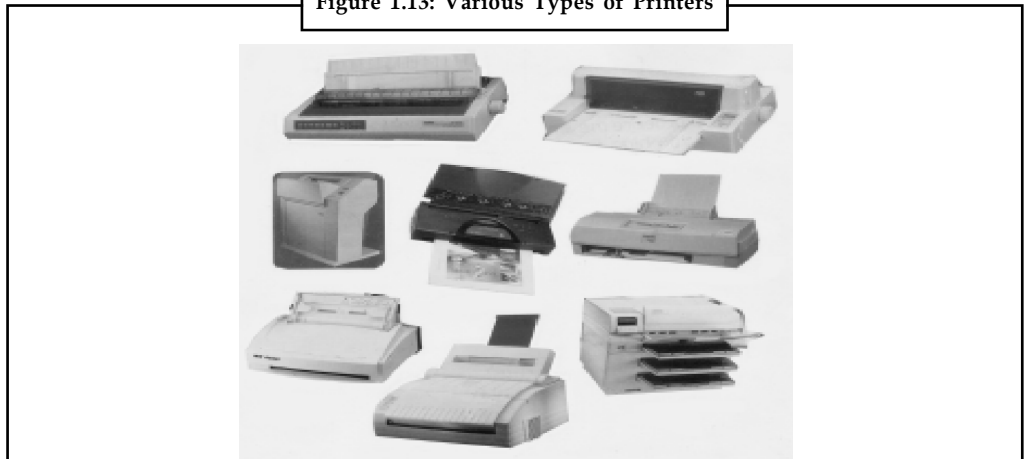



On the basis of the way impressions are made on the paper, printers are of two types:

Notes

- **Impact printers:** In these types of printers, printing takes place by striking at the paper through a ribbon soaked in ink. The impression on the paper is created by pressing a rigid object over an ink-soaked ribbon.
- **Non-impact printers:** In this type of printers there is no physical touch of any object on the paper. On the basis of how much is printed in a single operation, printers are of three types:
  - **Character printers:** These types of printers are capable of printing one character or letter at a time. The conventional typewriter also types a letter at a time.
  - **Line printers:** These printers can print one line of characters or letters in one go. Line printers are obviously much faster than character printers. However, they are more expensive than character printers.
  - **Page printers:** As the name suggests page printers can print the whole page at one time. These printers are fastest but costliest at the same time.
- **Dot Matrix Printer (High Speed Printer):** Dot matrix printers are impact printers. The printer head has an assembly of a fixed number of pins and tiny hammers. These hammers strike at the pins, which in turn make impression of dots on the paper loaded in the printer through an ink-soaked ribbon.
- **Inkjet printer:** This type of printer belongs to non-impact class. Characters are formed as a result of electrically charged or heated ink being sprayed in fine jets onto the paper. The printer head consists of nozzles. Individual nozzles produce high resolution (up to 400 dots per inch or 400 dpi) dot matrix characters. Magnetized plates in the ink's path direct the ink onto the paper in the desired shape. Inkjet printers are capable of producing high quality print approaching that produced by laser printers.
- **Laser printer:** This printer also belongs to non-impact type. A drum is initially electrically charged and then a high intensity laser beam is used to discharge selected areas on the drum where nothing is to be printed. These discharged areas correspond to the white area of the printed document. Dry ink or toner is attracted to parts of the drum with a high charge. The drum rotates and transfers the toner to the paper which has an even greater electrical charge. Finally a heater fixes the toner onto the paper. After printing this page the drum is cleaned by de-electrifying it. The process continues for another page. These printers are fast (6-8 pages per minute) and a very high resolution (300 - 600 dpi) but are costliest of all the printers.
- **Color Printers:** Color printers are the new standard in digital color printing. The complete family of digital color printers effectively balances low total cost of ownership with high levels of performance and productivity to directly benefit your bottom line. Compared with other color laser printers, the new C5000, C7000 and C9000 Series printers employ our innovative Digital LED and OKI Single Pass Color technologies. These technologies allow our digital printers to deliver high-speed, high-resolution, high-quality print output, and unmatched media flexibility, unsurpassed in the industry. Color printers from OKI Printing Solutions enable you to create high-impact color reports, presentations, mailers, banners and many other types of printed business communications, without the expense of using outside commercial printers.
- **Dye Sublimation Printers:** "Dye-sub" printers were among the first photo-quality color computer printers, emerging in the early 1990s. Sadly most of the prints made with these

Notes

machines had faded by the time we entered the New Millennium. The latest dye-sub printers allegedly produce more archival prints but this whole technology seems to be fading in favor of ink jet. Color management is a problem with dye-sub, as with ink jet. These are CMYK devices.

- **Fujix 3000 (and now 4000):** Though rather long in the tooth, this is the choice of most imaging professionals. The Fujix machines uses three lasers to expose a specially treated “donor paper” which is then thermally developed and transferred onto “receiver paper”. It is a traditional silver halide process but one need not maintain chemistry or clean processor rollers. Resolution is 400 dpi on an 8.5x11 sheet (Fujix 3500) or 12x18 (Fujix 4000). Image quality is the best of any printer available, comparable to an Ilfochrome, and archival qualities are reputed to be good. The printer is a standard piece of office equipment and the expended donor paper goes back UPS to Fuji for recycling and disposal. Consumables cost \$2-4 per page and you can make transparencies as well as opaque photos.
- **Barcode printers:** Barcode printers typically come in fixed sizes of 4 inches, 6 inches or 8 inches wide. Although a number of manufacturers have made differing sizes in the past, most have now standardised on these sizes. The main application for these printers is to produce barcode labels for product and shipping identification.
- **Label Printers:** Labels come in two main types: Thermal (sometimes referred to as Direct Thermal) and Thermal Transfer. A huge variety of specialist materials and adhesives are available to suit most applications. These include plain white paper packaging labels, durable rating plates, and tamper-evident labels.

### 1.1.4 Storage Devices

Primary memory (especially RAM) stores the data, instructions and information temporarily during processing by CPU. When the computer is switched off, this memory gets erased. How does a computer store the data, information and software permanently, so that they can be retrieved whenever required? Certainly, there must be some storage devices in the computer. Now, we will discuss about different Storage Devices, sometimes also called as Secondary Memory Devices.

There are many storage devices used with microcomputers. Some of the common storage devices are explained below and are shown in Figure 1.14.

Figure 1.14: Common Storage Devices

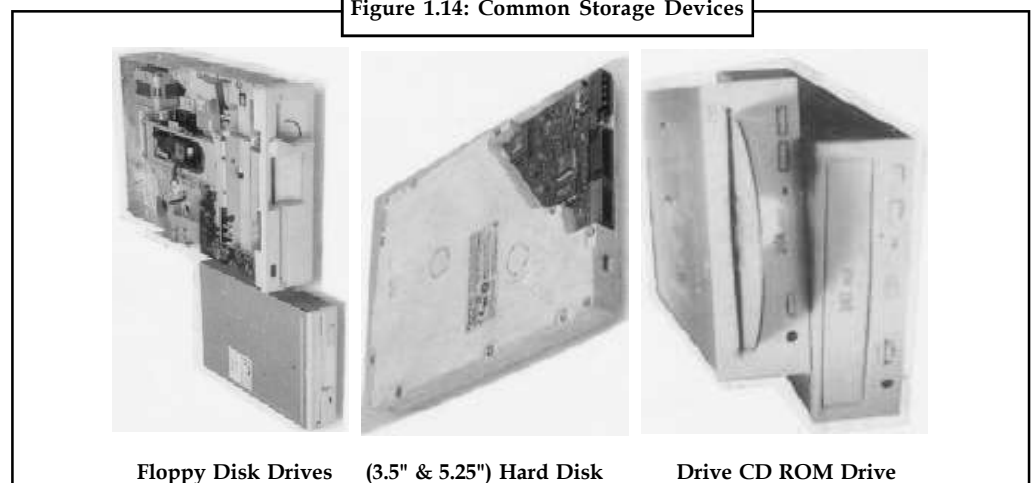

Data is stored inside a computer in the memory. The storage capacity of a memory device is measured in the following units:

- 1 Nibble = 4 bits
- 1 Byte = 8 bits
- 1 Kilobyte (KB) = 1024 Bytes (2<sup>10</sup>)
- 1 Megabyte (MB) = 1024 KB
- 1 Gigabyte (GB) = 1024 MB
- 1 Terabyte (TB) = 1024 GB

These devices are non-volatile. The stored data remains there as long as not erased intentionally.

### Magnetic Storage Devices

This type of storage device has a layer of coating of some magnetic substance on a rigid or flexible surface. The drive is equipped with a read-write head assembly that can convert the data and instructions represented in the form of 0 and 1 into some form of magnetic signal. These magnetic signals can then be stored on the medium.

- **Floppy disks:** Floppy disk was introduced by IBM. The first floppy disks used to be 8-inch in diameter. As it got smaller and smaller gradually it started being called diskette. Next smaller diskette was 5.25-inch in diameter. These days' 3.5-inch diameter diskettes having 1.44 MB storage space are most popular on microcomputers for storing data and programs. You can easily calculate that as many as 400 pages of printed book can be stored on a single floppy disk.

A floppy disk is provided with a small sliding switch called write-protect notch.



**Caution** If this switch is on (that is when you can see through the whole from one side to another) nothing can be written on the disk. This facilitates data safety. If this switch is on, your data cannot be deleted.

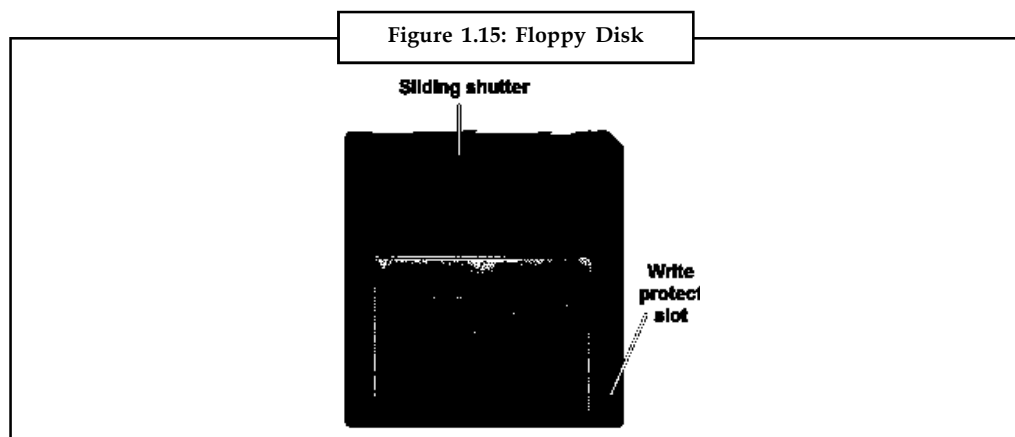

- **Hard disks:** Hard disks have existed since 1950s. Earlier they used to be 20 inches in diameter, holding just a few megabytes. Hard disks have hard platters that hold the magnetic medium, as opposed to the flexible plastic film found in tapes and floppies. A hard disk is able to store a large amount of information in a small space (usually 40GB).

Notes

A hard disk can also access any of its information in a fraction of a second. Unlike floppy disks hard disks are packed with the drive itself. A typical hard-disk drive looks like the one shown below.

Figure 1.16: Hard Disk



Hard disks have very large capacity. They are thus used to store data and programs that are very frequently used. Because of their fast speed they mostly act as active storage or online storage rather than backup storage.

Hard disk drives are fixed inside the computer casing and hence are not easily removable. They are not as portable as floppy disks are. However, some hard disks are detachable and can be inserted into a drive just like floppy disks.

Hard disks are very delicate and can easily get damaged if some pressure is applied on the drive. It can also get damaged if it suffers jerks when it is being carried from one place to another. It is also very sensitive to power fluctuations.

- **Magnetic tapes:** Magnetic tapes are similar to the tapes that you see in audio cassettes or video cassettes. Large computer systems use this medium for data storage purposes mostly as data backup. They are strictly sequential access media. Tapes are divided into tracks (usually 7 or 9 in number) running parallel to the length of the tape. One of the tracks is used to detect data transmission errors and to control them. Magnetic tapes can store as much as 10GB of data. It is reusable. You can erase it and rewrite new data. It has high data transfer rate and is yet cheap. However, the main disadvantage of a magnetic tape is that it allows only sequential access. The records cannot be easily updated and modified without copying them on another medium. Tapes are not long lasting and are very vulnerable to heat and magnetic disturbances.
- **Zip disks:** Zip disks are similar in looks to floppy disks. They are slightly bigger and thicker than floppy disks. On a Zip disk however, the magnetic coating is of much higher quality. The read/write head is significantly smaller than that of a floppy disk (by a factor of 10 or so). The smaller head, combined with a head positioning mechanism similar to that used in a hard disk enables a Zip drive to pack thousands of tracks per inch on the track surface. Zip drives also use a variable number of sectors per track to make the best use of disk space. All of these things combine to create a floppy disk that holds a huge amount of data.



Notes Their capacity typically lies between 100MB and 250MB, making them ideally suited for backing up data and programs from the hard disks.

## Optical Storage Devices

Notes

In these types of storage media signals stored are in the form of light. 0's and 1's are converted into light information and is stored on the media by read-write head assembly of the driver. Conversely, while reading the disk, bit-pattern of 0's and 1's stored on it are generated.

- **CD-ROM:** CD-ROM stands for Compact Disk-Read Only Memory. It is an optical disk impressed with a series of spiral pits in a flat surface. A CD is burnt by high-intensity laser beams in bit-pattern form which can be read optically by laser.

Figure 1.17: CD-ROM



The optical disk is a random access storage medium; information can be easily read from any point on the disk. A standard CD-ROM can store up to 650Mb of data, with 14,500 tracks per inch (tpi). That is equivalent in space to as many as 465 floppy disks! With this capacity, an entire encyclopedia can be stored on a CD. Not only text but animation, video and sound can also be stored.

Writing data and/or programs on a CD is known as burning the CD. There are CDs on which data and programs can be written only once but can be read any number of times. Such CDs are called write-once CDs. There are other CD-ROMs where information can be written onto them by the user. These are called read/writable CD-Rs and these are becoming a popular and cheap method for storage. With the help of CD-Writer (CDWR) drive you can use such disks again and again.

- **DVD-ROM:** DVD stands for Digital Versatile Disks. They look identical to a CD-ROM. However, DVD can store between 4.7GB and 17GB of data. They are used for storage of high quality video and audio applications. Movies are frequently stored on DVDs.
- **CD-Recordable:** CD-R (for compact disc, recordable) is a type of write once, read many (worm) compact disc (CD) formats that allows one-time recording on a disc. The CD-R (as well as the CD-RW) format was introduced by Philips and Sony in their 1988 specification document, the Orange Book. Prior to the release of the Orange Book, CDs had been read-only audio (CD-Digital Audio, described in the Red Book), to be played in CD players, and multimedia (CD-ROM), to be played in computers' CD-ROM drives. After the Orange Book, any user with a CD recorder drive could create their own CDs from their desktop computers.
- **CD-Rewritable:** CD-RW (for compact disc, rewriteable) is a compact disc (CD) format that allows repeated recording on a disc. The CD-RW format was introduced by Hewlett-Packard, Mitsubishi, Philips, Ricoh, and Sony, in a 1997 supplement to Philips and Sony's Orange Book. CD-RW is Orange Book III (CD-MO was I, while CD-R was II). Prior to the release of the Orange Book, CDs had been read-only audio (CD-Digital Audio, described fully in the Red Book), to be played in CD players, and multimedia (CD-ROM), to be played in computers' CD-ROM drives. After the Orange Book, any user with a CD Recorder drive could create their own CDs from their desktop computers. CD-RW drives can write both CD-R and CD-RW discs and can read any type of CD.

Notes

- **Photo CD:** Photo CD is a system introduced by Kodak for digitizing and storing black and white or color negatives or transparencies on compact disks your computer can read. Each disk can hold about 100 high quality images.

**Self Assessment**

Fill in the blanks:

1. .... is the main component or “brain” of a computer, which performs all the processing of input data.
2. .... is a pointing device is used to select a displayed menu item or draw pictures on the monitor screen.
3. A ..... is an internal circuit board that allows a display device to display images from the computer.
4. .... storage device has a layer of coating of some magnetic substance on a rigid or flexible surface.
5. In ..... storage, media signals stored are in the form of light.

**1.2 Network System**

The worldwide system of computer networks is the Internet, a network of networks. Via the Internet, computers on the network can access other computers on the network. The Internet allows data to be moved from one computer to another.

The network system manages how data is transferred from one computer to another and how different components of a network system work together. Figure 1.18 illustrates the network components needed for a computer to communicate to other computer via the Internet.

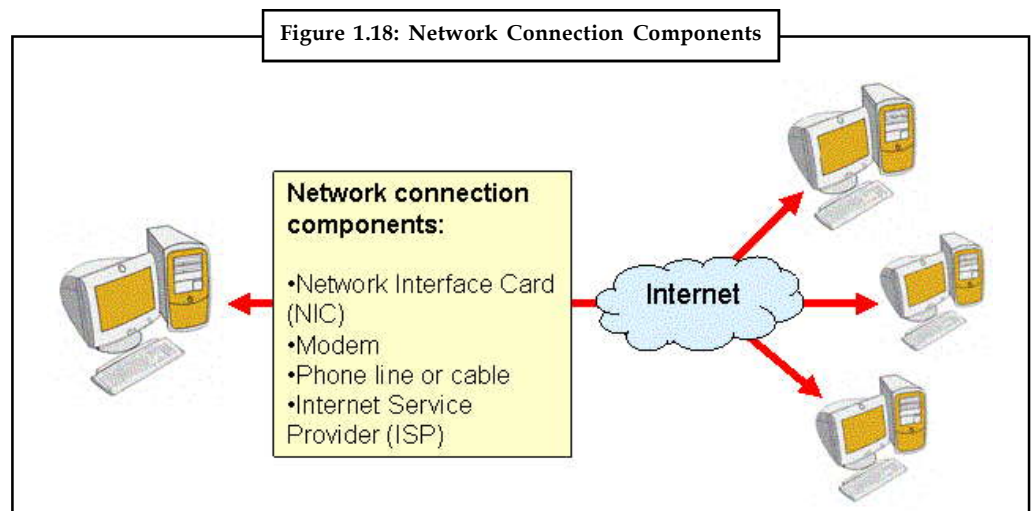

A network interface card (NIC) sends data from a computer over a network, and collects incoming data sent by other computers. A modem is a device that enables data from a computer to be transmitted via phone lines or television cable lines to reach other computers on the Internet. In addition to these hardware network components, a computer also needs an Internet service provider such as America Online to enable its connection to the Internet. Application software such as Web browsers and electronic mail also enhance the usefulness of a network system.



*Example:* Web browsers include Internet Explorer and Netscape.



*Example:* Electronic Mail include Outlook and Netscape Mail.

### 1.2.1 Types of Networks

Computer networks are of three types:

1. Local area networks (LAN)
2. Metropolitan area networks (MAN)
3. Wide area networks (WAN)

We shall discuss each of these in detail.

#### Local Area Network (LAN)

A Local Area Network (LAN) is a group of computers and associated devices that share a common communications line or wireless link and share the resources of a single processor or server within a small geographic area usually within an office building. Usually, the server has applications and data storage that are shared in common by multiple computer users. A local area network may serve as few as two or three users (for example, in a home network) or as many as thousands of users.

LANs have become commonplace in many organisations for providing telecommunications network capabilities that link end users in offices, departments, and other work groups. In summary, a LAN is a communications network which is:

- Local i.e. one building or group of buildings
- Controlled by one administrative authority
- Assumes other users of the LAN are trusted
- Usually high speed and is always shared

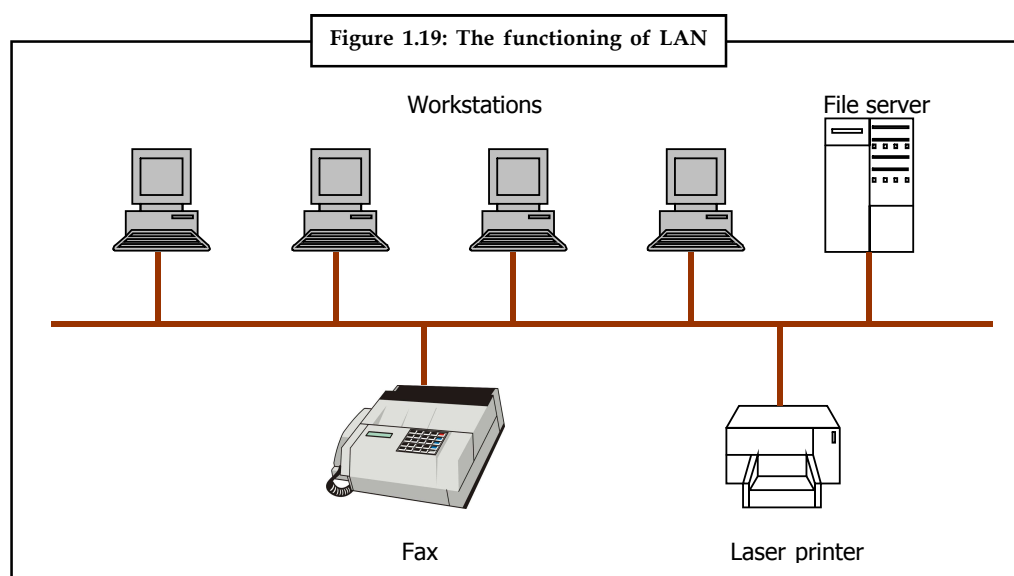

**Notes**

Some applications performed by a LAN are as follows:

1. File transfer and access
2. Accessing the internet
3. Providing Management Information System.

**Wide Area Network (WAN)**

Wide Area Network (WAN) is a telecommunication network which covers a large geographical area, and uses communications circuits to connect the intermediate nodes. A wide area network spans a wide geographical area such as a state or country. Numerous WANs have been constructed, including public packet networks, large corporate networks, military networks, banking networks, stock brokerage networks, and airline reservation networks. WANs are used for many different purposes. Some are designed as a communications backbone for a large distributed organisation. Other WANs focus on particular transaction packages. Many WANs are used to transfer and consolidate corporate data, such as daily transaction summaries from branches. Some WANs are very extensive, spanning the globe, but most do not provide true global coverage. A major factor which influences WAN design and performance is the requirement of lease communications circuits from telephone companies or other communications carriers.



*Did u know?* Transmission rates are typically 2 Mbps, 34 Mbps, 45 Mbps, 155 Mbps, 625 Mbps or sometimes even more.

A WAN system is shown in the figure 1.20. This connects a number of End Systems and a number of Intermediate Systems to form a network over which data may be communicated between the End Systems.



*Example:* In figure 1.20, A, C, H, K are the end systems and B, D, E, F, G, I, J are intermediate systems.

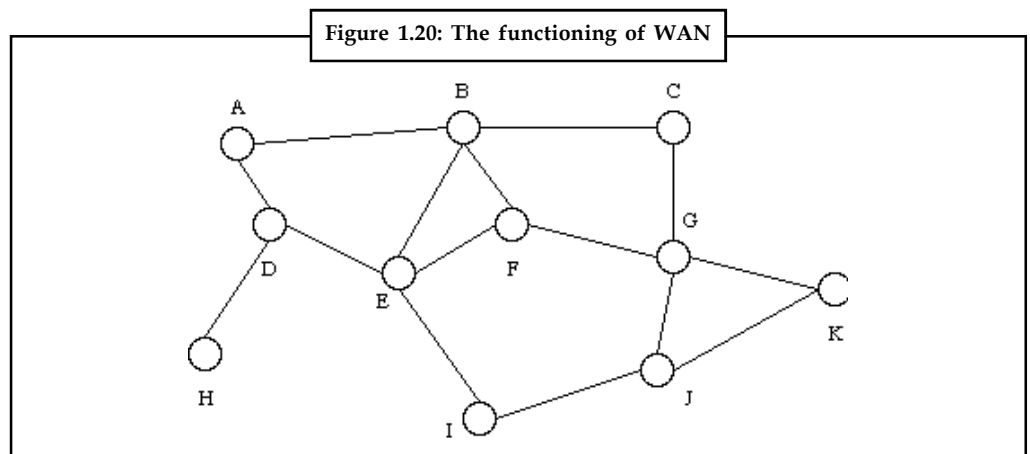

**Metropolitan Area Network (MAN)**

A Metropolitan Area Network (MAN) is one of a number of types of networks. A MAN is a relatively new class of network; it serves a role similar to an ISP, but for corporate users with large LANs. It is a network that interconnects users with computer resources in a geographical area larger than that covered by even a large local area network (LAN) but smaller than the area



covered by a wide area network (WAN). The term is applied to the interconnection of networks in a city into a single larger network (which may then also offer efficient connection to a wide area network). It is also used to mean the interconnection of several local area networks by bridging them with backbone lines. This is sometimes referred to as a campus network. Large universities also sometimes use the term to describe their networks. A recent trend is the installation of wireless MANs.

A typical use of MANs to provide shared access to a wide area network is shown in the figure 1.21:

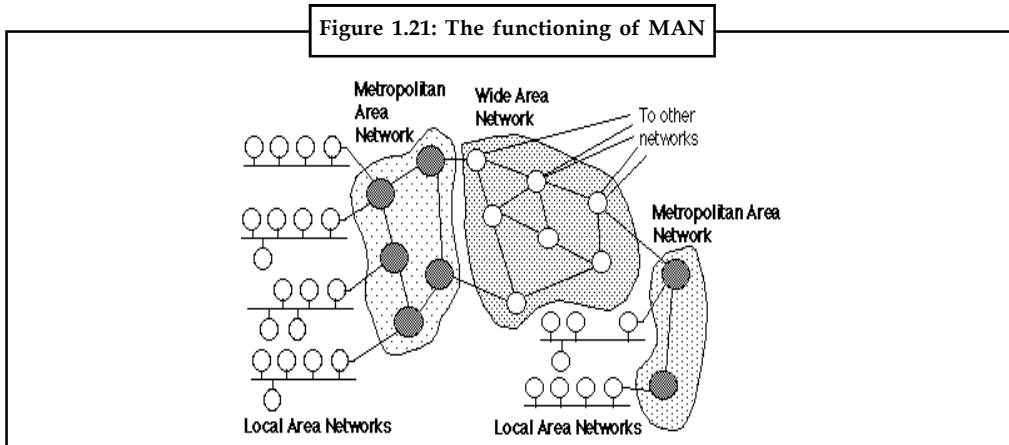

*Task* Make distinction between MAN and WAN.

## Self Assessment

Fill in the blanks:

1. The ..... system manages how data is transferred from one computer to another.
2. A ..... sends data from a computer over a network, and collects incoming data sent by other computers.
3. A ..... is a group of computers and associated devices that share the resources of a single processor or server within a small geographic area usually within an office building.
4. A ..... spans a wide geographical area such as a state or country.
5. .... is used to mean the interconnection of several local area networks by bridging them with backbone lines.

## 1.3 Computer Software

Software is the term used to describe the set of instructions that tells the hardware how to perform a task. They include operating system software, application and utility software. Software is a collection of computer programs that allows the users to use the computer for a specific purpose. Without software the hardware can do nothing useful. No software no work! By creating appropriate software a computer may be made to do almost anything under its capability.

**Notes**

Software, loaded into the primary memory, is lost the moment power supply to the memory is switched off. Therefore, software is usually stored on secondary storage devices so that you do not have to enter it into the computer's memory each time through an input device. *A software is a program or set of instructions, which is required to use the computer.* Many types of software are available for various applications. The software development field is so advanced that day by day existing software are becoming outdated and new software are coming in the market.

Software can be classified on a number of different bases. On the basis of the purpose served, they can be classified as follows:

1. System software
2. Application software

### 1.3.1 System Software

All the hardware components are also referred to as hardware resources. System software is the collection of programs that control the functioning of all the hardware resources directly. No computer hardware exists in operational condition unless it is equipped with system software.

System software is not directly visible to the users. Most of the system software automatically gets loaded into the main memory when the computer system is switched on.

The most important system software is an operating system. An operating system is system software that controls the functions of all the resources. Without this a user cannot do anything with a computer. Operating systems are responsible for getting commands or a program from a user and getting it executed by the relevant hardware. You have to learn the commands of an operating system to interact with the computer running that operating system. It also controls the storage and retrieval of data and programs to and from secondary storage devices. The relation between operating system, hardware and application software is shown in figure 1.22:

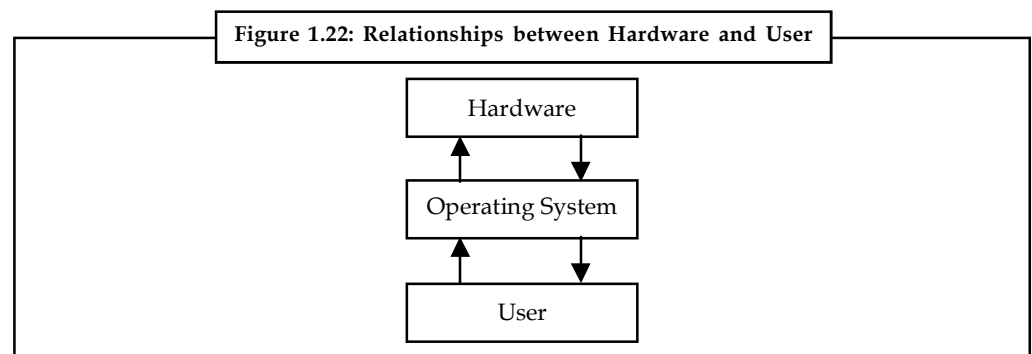

There are a number of operating systems available to the computer-users, these days. Some of the most popular ones for personal computers are:

- **DOS (Disk Operating System):** Dos was the most popular operating system used on personal computers before the advent of Windows operating system. It was developed by Microsoft Corporation for IBM (International Business Machines) personal computers (PCs) and IBM compatible computers. It was small in size and could be stored on a single floppy disk, thus the name. It has been now replaced with Windows operating system almost entirely. IBM created its own version of Dos later on. It was named PC-DOS to differentiate it from Microsoft's version of DOS which is subsequently known as MS-DOS.
- **Windows:** This operating system was also developed by Microsoft Corporation. It has become the most popular operating system on personal computers. The most important

feature of this operating system is that it uses Graphical User Interface (GUI). In GUI system the tasks are represented as small icons. Using a pointing input device like a mouse, a user can select a task and execute it by clicking at it. The earliest version of this user-friendly operating system was Microsoft Windows 3.0 released in early 90s, Windows was well taken by the personal computer community. Since then the Windows has undergone a number of revisions resulting in Windows 3.1, Windows 95, Windows 98, Windows NT to the latest versions Windows 2000 and Windows XP. This has been done in order to cater to the emerging computing environments and increasing needs.

- **OS/2:** This operating system was designed for more powerful microcomputers.
- **Macintosh:** This operating system has been developed for Apple computers. It has very user-friendly and powerful GUI.
- **UNIX:** This is a multi-user, multi-processing and multi-tasking operating system. It is very popular with bigger computers like mini computers.
- **LINUX:** This operating system was developed based on UNIX. It is available to the user for free. It is very useful for web-site development and hosting on the Internet. It has very rich and powerful set of networking functions.

If installed on a computer, operating systems load automatically into the memory once the computer is started without any intervention from the users. This process is called bootstrapping or booting.

### 1.3.2 Application Software

Application software is a defined subclass of computer software that employs the capabilities of a computer directly to a task that the user wishes to perform. Application software is the name given to the programs that perform specific tasks for users. Application software consists of Programs that direct computers to perform specific information processing activities for end users. These programs are called application packages because they direct the processing required for a particular use, or application, which users want to accomplish. Thousands of application packages are available because there are thousands of different jobs end users want computers to do.



*Example:* Games, instant messengers, word processors, and antivirus programs are all applications.

Applications software is any type of software that you use on a computer that helps the user complete a specific task.

Application software includes a variety of programs that can be subdivided into general-purpose and application-specific categories.

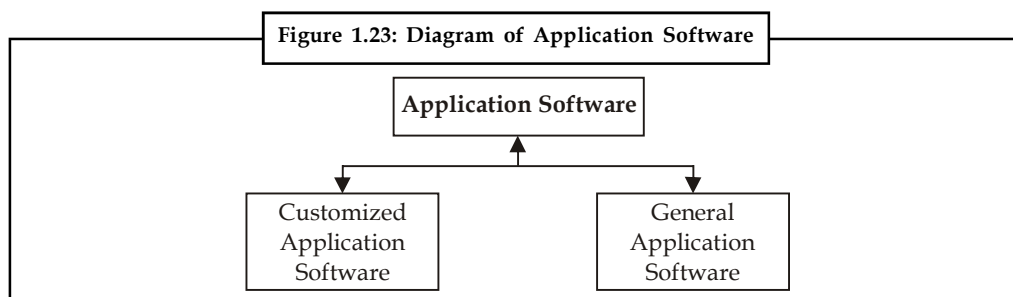

Source: <http://library.thinkquest.org/08aug/01795/Website/software.html>

Notes

1. **General-Purpose Application Programs:** General-purpose applications packages are programs that perform common information processing jobs for end users. This type of software is developed keeping in mind the general requirements for carrying out a specific task. Many users can use it simultaneously as it fulfills the general requirements.



*Example:* Word processing programs, electronic spreadsheet programs, database management programs, graphics programs, communications programs, and integrated packages are popular with microcomputer users for home, education, business, scientific, and many other general purposes.

They are also known as productivity packages, because they significantly increase the productivity of end users. This packaged software is also called off-the-shelf software packages, because these products are packaged and available for sale. Many features are common to most packaged programs.

2. **Customized-Specific Software:** This type of software is tailor-made software. The software is developed to meet all the requirements specified by the user. Many application programs are available to support specific applications of end users. Business Application Programs that accomplish the information processing tasks of important business functions or industry requirements.

Some of the most frequently-used application software are:

- **Word processor:** Word processing is a set of activities involving writing letters and documents, editing them and printing them. The software, which allows you to carry out these activities on a computer, is known as word processor. Microsoft Word, Ami Pro, Word Star, Soft Word are some popular word processing software packages.
- **Spreadsheets:** Engineers, researchers and managers have to make lot of calculations. They use a large sheet of paper divided into cells or boxes. They write the figures into these cells and make further calculations based on these figures. Each time they make any change in one cell they have to update all other cells with the current result. Such a sheet is known as spreadsheet. An application software that allows the users to use a computer like a spreadsheet is known as spreadsheet software. Some popular spreadsheet software packages are Microsoft Excel and Lotus-123.
- **Database management systems:** Organizations have lots of information to record and maintain. They also have to perform calculations and processing on the stored information. A collection of large volume of systematically organized data is known as database. A database needs management continuously. An application-software that allows the users to use a computer for database management is known as database management system. Microsoft Access, Dbase, FoxBase, FoxPro, Oracle, Sybase, DB2, Focus, Ingress, Microsoft SQL Server are some of the most popular database management systems.
- **Graphics packages:** A lot of artwork and drawing are nowadays done using computers. An application-software that allows one to draw and manipulate images is known as graphics software. Graphics-software helps users manipulate visual images. CorelDraw and Adobe Photoshop are very popular graphics software packages.
- **Communication software:** Computers are playing a very important role in communication. Through the Internet you can send and receive e-mails. Cellular phones use computers at the back-end extensively. An application-software that allows one to carry out electronic communication through computer is known as communication software.

A user can send and receive e-mails using software called e-mail client. An on-line e-mail client allows accessing mails only when connected to the Internet while an off-line e-mail client lets

the users read e-mails even when not connected to the Internet. Microsoft Outlook Express, Organizer, Eudora Lite, etc., are a few very popular e-mail clients.

It is clear, therefore, that a computer can function differently according to the software running on it. For a user, a computer is nothing but the software running on it!

## Self Assessment

Fill in the blanks:

1. .... is the term used to describe the set of instructions that tells the hardware how to perform a task.
2. .... is the collection of programs that control the functioning of all the hardware resources directly.
3. An ..... is system software that controls the functions of all the resources.
4. .... is a defined subclass of computer software that employs the capabilities of a computer directly to a task that the user wishes to perform.
5. .... applications packages are programs that perform common information processing hobs for end users.

## 1.4 Summary

- Input devices are used to input data, information and instructions into the RAM.
- Output devices are divided into two basic categories: those that produce hard copy, including printers and plotters; and those that produce soft (digital) copy, including monitors (the most commonly used output devices).
- *Central Processing Unit* (CPU) is the main component or “brain” of a computer, which performs all the processing of input data.
- The network system manages how data is transferred from one computer to another and how different components of a network system work together.
- Software is the term used to describe the set of instructions that tells the hardware how to perform a task.
- System software is a collection of software programs that enable the user to interact with the computing device without getting lost among the complexities of technical interactions between mechanical parts and machine-oriented codified programs.
- An operating system is a collection of integrated computer programs that provide recurring services to other programs or to the user of a computer.
- Applications software is any type of software that you use on a computer that helps the user completes a specific task.

## 1.5 Keywords

**Application software:** It is a defined subclass of computer software that employs the capabilities of a computer directly to a task that the user wishes to perform.

**Central Processing Unit:** A central processing unit (CPU) is the hardware within a computer that carries out the instructions of a computer program by performing the basic arithmetical, logical, and input/output operations of the system.

**Notes**

**Hardware:** Hardware is a general term that refers to the physical artifacts of a technology.

**Input devices:** These are hardware equipment that receive data and instructions from users, convert the data and instructions into a form that can be processed by the computer and passes the same to the computer.

**Operating System:** An operating system is a collection of integrated computer programs that provide recurring services to other programs or to the user of a computer.

**Output Device:** An output device is hardware equipment that translates this non-readable result into a form understood by the users.

**Software:** The programs and other operating information used by a computer.

**System software:** System software is a collection of software programs that enable the user to interact with the computing device without getting lost among the complexities of technical interactions between mechanical parts and machine-oriented codified programs.

**1.6 Review Questions**

1. Describe the internal working of CPU.
2. Make distinction between Input and Output Devices.
3. Explain various input and output devices.
4. Discuss the concept of Magnetic Storage Devices.
5. Explain the different types of computer networks.
6. Explain the concept of computer software.
7. "System software controls a computer and provides the environment for users to run application software." Elucidate.
8. Do you agree with the statement that Operating System is software that works as an interface between a user and the computer hardware? Give reasons with support of your answer.
9. Describe various operating systems available to the computer-users.
10. Discuss the most frequently used application software.

**Answers: Self Assessment**

- |                                 |                             |
|---------------------------------|-----------------------------|
| 1. CPU                          | 2. Light pen                |
| 3. video adapter                | 4. Magnetic                 |
| 5. optical                      | 6. Network                  |
| 7. network interface card (NIC) | 8. Local Area Network (LAN) |
| 9. wide area network (WAN)      | 10. MAN                     |
| 11. Software                    | 12. System software         |
| 13. operating system            | 14. Application software    |
| 15. General-purpose             |                             |

## 1.7 Further Readings

Notes



Books

Barrett, Diane. & King, Todd (2005). *“Computer networking illuminated.”* Jones & Bartlett Learning.

Blundell, Barry (2008). *“Computer hardware.”* Cengage Learning EMEA.

Englander, Irv (2003). *“The architecture of computer hardware and systems software: An Information Technology Approach.”* Wiley.

Sarkar, Nurul (2006). *“Tools for Teaching Computer Networking And Hardware Concepts.”* Information Science Pub.

Shinder, Bebra Littlejohn (2001). *“Computer Networking Essentials.”* Cisco Press.



Online links

<http://ecomputernotes.com/fundamental/disk-operating-system/what-is-operating-system>

<http://faculty.ivytech.edu/~smilline/downloads/hardware.pdf>

<http://home.olemiss.edu/~misbook/sm2.htm>

<http://www.grassrootsdesign.com/intro/hardware>

<http://www.techterms.com/definition/systemsoftware>

## Unit 2: CPU Components

### CONTENTS

Objectives

Introduction

2.1 Motherboards

2.1.1 Types of Motherboards

2.1.2 Designs of the Motherboard

2.2 Chipsets

2.2.1 North and South Bridge

2.3 Concept of Microprocessor

2.3.1 Embedded Applications

2.3.2 8-bit Designs

2.3.3 12-bit designs

2.3.4 16-bit designs

2.3.5 32-bit Designs

2.3.6 64-bit designs in Personal Computers

2.4 Latest Chipsets and Microprocessors available in Market

2.5 Basics and Types of Floppy drive/HDD/DVD/RAM etc.

2.5.1 Floppy Drive

2.5.2 Hard Disk Drive (HDD)

2.5.3 Digital Video Disk (DVD)

2.5.4 RAM

2.5.5 Switching-Mode Power Supply (SMPS)

2.6 Summary

2.7 Keywords

2.8 Review Questions

2.9 Further Readings

### Objectives

After studying this unit, you will be able to:

- Explain the concept of motherboards
- Describe the concept of Chipsets & Microprocessor
- Discuss basics and types of Floppy drive/HDD/DVD etc.



## Introduction

Notes

A central processing unit (CPU), also referred to as a central processor unit, is the hardware within a computer that carries out the instructions of a computer program by performing the basic arithmetical, logical, and input/output operations of the system. The term has been in use in the computer industry at least since the early 1960s. The form, design, and implementation of CPUs have changed over the course of their history, but their fundamental operation remains much the same. In older computers, CPUs require one or more printed circuit boards. With the invention of the microprocessor, a CPU could be contained within a single silicon chip. The first computers to use microprocessors were personal computers and small workstations. Since the 1970s the microprocessor class of CPUs has almost completely overtaken all other CPU implementations, to the extent that even mainframe computers use one or more microprocessors. Modern microprocessors are large scale integrated circuits in packages typically less than four centimeters square, with hundreds of connecting pins. A computer can have more than one CPU; this is called multiprocessing. Some microprocessors can contain multiple CPUs on a single chip; those microprocessors are called multi-core processors.

## 2.1 Motherboards

A motherboard (sometimes alternatively known as the mainboard, system board, planar board or logic board, or colloquially, a mobo) is the main printed circuit board (PCB) found in computers and other technological systems. It holds many of the crucial electronic components of the system, such as the central processing unit (CPU) and memory, and provides connectors for other peripherals. Unlike a back-plane, a motherboard contains significant sub-systems such as the CPU.

Motherboard specifically refers to a PCB with expansion capability - the board is the "mother" of all components attached to it, which often include sound cards, video cards, network cards, hard drives or other forms of persistent storage, TV tuner cards, cards providing extra USB or Fire-wire slots, and a variety of other custom components. (The term mainboard is applied to devices with a single board and no additional expansions or capability - in modern terms this would include controlling boards in televisions, washing machines and other embedded systems, which are not true motherboards.)

A motherboard provides the electrical connections by which the other components of the system communicate. Unlike a backplane, it also connects the central processing unit and hosts other subsystems and devices.

A typical desktop computer has its microprocessor, main memory, and other essential components connected to the motherboard. Other components such as external storage, controllers for video display and sound, and peripheral devices may be attached to the motherboard as plug-in cards or via cables, in modern computers it is increasingly common to integrate some of these peripherals into the motherboard itself.

An important component of a motherboard is the microprocessor's supporting chipset, which provides the supporting interfaces between the CPU and the various buses and external components. This chipset determines, to an extent, the features and capabilities of the motherboard.

Modern motherboards include, at a minimum:

- Sockets (or slots) in which one or more microprocessors may be installed. In the case of CPUs in BGA packages, such as the VIA C3, the CPU is directly soldered to the motherboard,
- Slots into which the system's main memory is to be installed (typically in the form of DIMM modules containing DRAM chips)

**Notes**

- A chipset which forms an interface between the CPU's front-side bus, main memory, and peripheral buses
- Non-volatile memory chips (usually Flash ROM in modern motherboards) containing the system's firmware or BIOS
- A clock generator which produces the system clock signal to synchronize the various components
- Slots for expansion cards (these interface to the system via the buses supported by the chipset)
- Power connectors, which receive electrical power from the computer power supply and distribute it to the CPU, chipset, main memory, and expansion cards. As of 2007, some graphics cards (e.g. GeForce 8 and Radeon R600) require more power than the motherboard can provide, and thus dedicated connectors have been introduced to attach them directly to the power supply. Most disk drives also connect to the power supply via dedicated connectors.

Additionally, nearly all motherboards include logic and connectors to support commonly used input devices, such as PS/2 connectors for a mouse and keyboard. Early personal computers such as the Apple II or IBM PC included only this minimal peripheral support on the motherboard. Occasionally video interface hardware was also integrated into the motherboard;



*Example:* On the Apple II and rarely on IBM-compatible computers such as the IBM PC Jr.

Additional peripherals such as disk controllers and serial ports were provided as expansion cards.



*Notes* Given the high thermal design power of high-speed computer CPUs and components, modern motherboards nearly always include heat sinks and mounting points for fans to dissipate excess heat.

### 2.1.1 Types of Motherboards

Motherboards are divided into the following two main categories.

#### Integrated Motherboards

Integrated motherboards come with all the essential components built in to them. The major advantage of this type of motherboard is that all major functions. This means that all the functions that your pc needs are already from the get-go on a single circuit board. As the price of pc technology has dropped over the years, there has been a big push towards integrating almost every aspect of a pc onto the motherboard. Although the only drawback is that if one of the components breaks you will have to replace the whole motherboard. However, this rarely happens. Another drawback is that sometimes the expansion slots for future upgrades of the motherboard or new components can be limited.

#### Non-integrated Motherboards

Non-integrated motherboards don't have most of the main components built into them, but they normally have more expansion slots to allow you to add your own. This can be preferable

for high performance PC users. They may want a more advanced soundcard or a top of the range network card, or video card if you are a serious pc gamer. The downside of this type of motherboard is that you need a larger case, and experience plugin components into the mainboard.

## 2.1.2 Designs of the Motherboard

Form Factors are the design of the motherboard. It is how the components of the mainboard are laid out, and especially what type of case they fit into, and so what power supply they will be using.

### ATX

ATX stands for Advanced Technology Extended. ATX was designed by Intel to allow easier expansion, and a higher degree of compatibility among component manufacturers, while still allowing the main components of a pc integrated into the motherboard. It's like the best of both integrated and non-integrated motherboards. There are specific design changes that have taken place over the years in motherboards and since the ATX is one of the most recent, you can see that the journey of motherboards has sometimes been drastic difficulties, including where the expansion slots are in relationship to the processor. It used to be that some motherboards couldn't have new components added to them, as there was no room because of other parts of the board. The power supply connector for an ATX board is a 20-pin, and can support soft power off.

### Micro ATX

The Micro ATX Form Factor motherboard is much smaller than ATX. The maximum motherboard size is 9.6" × 9.6". Micro ATX uses a compact design, which is favoured by pc manufacturers, who like to focus on space saving PC and designs for their customers. Typically their customers are not pc enthusiast who prefers to get their hands dirty. This is the reason and shift from a few years ago when a pc was an enormous tower, to the slim line versions that you see now. Normally the board will have more USB peripheral slots to allow external devices to be connected. There is also an even smaller version of the Micro ATX which is called the flex ATX. This is a motherboard at the size of 9.6" × 7.5". Don't expect to be able to add a pumping hot hardcore graphics card to motherboards like this.

### BTX

The BTX Form Factor is the smoothest of motherboard designs. It was designed to make sure that heat that is generated from the components is not concentrated in one place, and the motherboard can be kept cool by the primary airflow from the pc power supply.

### NLX

NLX or New Low Profile Extended Form Factor was the first effort of motherboard manufacturers at fitting slim line cases. The way they done this were to add riser expansion slots, which meant that the components would be parallel against the motherboard. This style was not popular amongst consumer of manufacturers, and quickly became replaced. That's the reason you have probably never heard of it. However the concept may return in the future, once the issues of heat and expansion are solved. It certainly is a good way to compact components into a small amount of space.

Notes

 <i>Task</i> Compare and contrast ATX and NLX.
--

**Self Assessment**

Fill in the blanks:

1. A ..... is the main printed circuit board (PCB) found in computers and other technological systems.
2. ....motherboards come with all the essential components built in to them.
3. .... Form Factor was the first effort of motherboard manufacturers at fitting slim line cases.

**2.2 Chipsets**

Since we now know that the chipset handles an incredible amount of data, it's important to see which chipsets are performing the best. Firstly to choose a chipset that supports your CPU. You obviously can't have a chipset designed for an Intel CPU if your using an AMD based CPU of course the motherboard you buy will clearly display which model of CPU it is for. Then the best way to see which chipsets are performing the best is to look at benchmarks on various internet sites. A slow chipset can be as damaging to your systems overall speed as a slow CPU or slow memory. The slowest component always dictates the overall speed at any given time. If you have a poor performing chipset, then any time that your computer is sending and receiving data from the graphics card or main memory, then the system is struggling.

The chipset is the "glue" that connects the microprocessor to the rest of the motherboard and therefore to the rest of the computer. On a PC, it consists of two basic parts the northbridge and the southbridge. All of the various components of the computer communicate with the CPU through the chipset.

The northbridge connects directly to the processor via the front side bus (FSB). A memory controller is located on the northbridge, which gives the CPU fast access to the memory. The northbridge also connects to the AGP or PCI Express bus and to the memory itself.

The southbridge is slower than the northbridge, and information from the CPU has to go through the northbridge before reaching the southbridge. Other busses connect the southbridge to the PCI bus, the USB ports and the IDE or SATA hard disk connections.

Chipset selection and CPU selection go hand in hand, because manufacturers optimize chipsets to work with specific CPUs. The chipset is an integrated part of the motherboard, so it cannot be removed or upgraded.



*Caution* Not only must the motherboard's socket fit the CPU; the motherboard's chipset must work optimally with the CPU.

**2.2.1 North and South Bridge**

The chipset normally consists of two major microchips. These are known as the North bridge and the South Bridge. Developments in chip technologies have meant that chipset and CPU manufacturers are changing the way the chipset layout works.



*Example:* Some CPU's come with a built in memory controller taking that job from the North Bridge, some chipsets have incorporated the north and south bridge in the same chip.

The North Bridge handles data for the graphics port whether that is AGP or PCI express and the main memory which includes the FSB (Front side bus). Although both chips are required for the PC to work the North Bridge handles most of the very important tasks such as the connection between the CPU and main memory bank. The South Bridge handles data from the PCI x1 slots and can also have integrated components such as Audio and/or onboard graphics.

The North and South bridges will have different chip names even though they are very often paired with the same opposite bridge to come under the collective name of the chipset. Below is a diagram of the KT600 chipset from VIA technologies. Figure 2.1 shows how the components of your PC are connected to the chipset.

Figure 2.1: Components of your PC are connected to the chipset

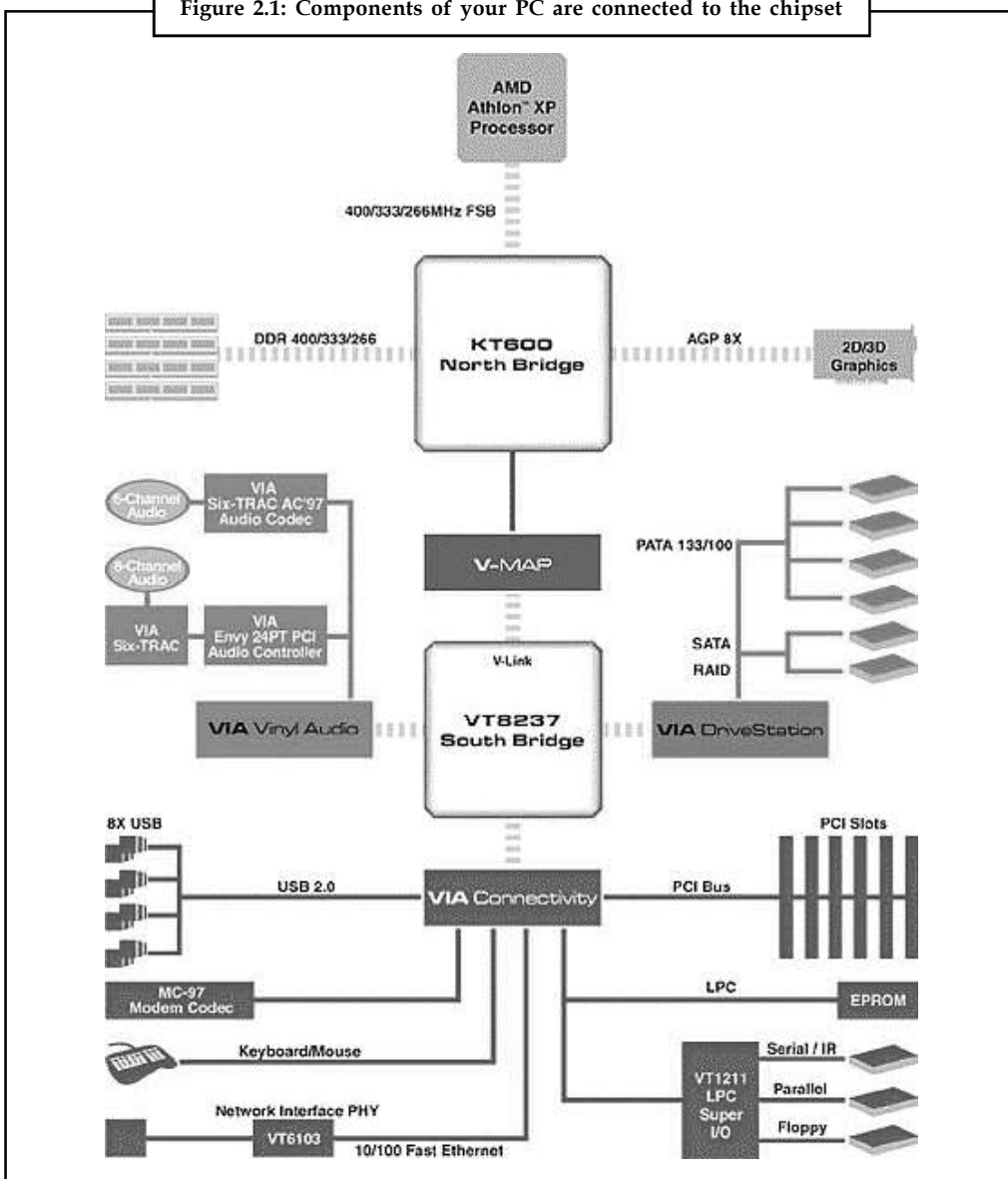

Source: <http://www.pantherproducts.co.uk/index.php?pageid=chipset>

**Notes**

Like stated above the chipset is responsible for directing data from the AGP/PCI 16x bus. So it does affect the graphics performance of your machine. But it also affects it in another way if you're using an older AGP card. You may notice that when you purchase a graphics card it will state on it what AGP Bus it can use i.e. 1x, 2x, 4x or 8x. This is how many channels the AGP bus can use to transmit data from the graphics card to the main memory.



*Did u know?* Support from the chipset to have 8 channels to the graphics card allows the graphics card to transmit greater amounts of data per second.

**Self Assessment**

Fill in the blanks:

1. The ..... is the "glue" that connects the microprocessor to the rest of the motherboard and therefore to the rest of the computer.
2. The northbridge connects directly to the processor via the .....
3. A ..... is located on the northbridge, which gives the CPU fast access to the memory.

**2.3 Concept of Microprocessor**

A microprocessor incorporates the functions of a computer's central processing unit (CPU) on a single integrated circuit (IC), or at most a few integrated circuits. It is a multipurpose, programmable device that accepts digital data as input, processes it according to instructions stored in its memory, and provides results as output. It is an example of sequential digital logic, as it has internal memory. Microprocessors operate on numbers and symbols represented in the binary numeral system.

The advent of low-cost computers on integrated circuits has transformed modern society. General-purpose microprocessors in personal computers are used for computation, text editing, multimedia display, and communication over the Internet. Many more microprocessors are part of embedded systems, providing digital control of a myriad of objects from appliances to automobiles to cellular phones and industrial process control.

**2.3.1 Embedded Applications**

Thousands of items that were traditionally not computer-related include microprocessors. These include large and small household appliances, cars (and their accessory equipment units), car keys, tools and test instruments, toys, light switches/dimmers and electrical circuit breakers, smoke alarms, battery packs, and hi-fi audio/visual components (from DVD players to phonograph turntables). Such products as cellular telephones, DVD video system and HDTV broadcast systems fundamentally require consumer devices with powerful, low-cost, microprocessors. Increasingly stringent pollution control standards effectively require automobile manufacturers to use microprocessor engine management systems, to allow optimal control of emissions over widely varying operating conditions of an automobile. Non-programmable controls would require complex, bulky, or costly implementation to achieve the results possible with a microprocessor.

A microprocessor control program (embedded software) can be easily tailored to different needs of a product line, allowing upgrades in performance with minimal redesign of the product. Different features can be implemented in different models of a product line at negligible production cost.

Microprocessor control of a system can provide control strategies that would be impractical to implement using electromechanical controls or purpose-built electronic controls.



*Example:* An engine control system in an automobile can adjust ignition timing based on engine speed, load on the engine, ambient temperature, and any observed tendency for knocking—allowing an automobile to operate on a range of fuel grades.

### 2.3.2 8-bit Designs

The Intel 4004 was followed in 1972 by the Intel 8008, the world's first 8-bit microprocessor. The 8008 was not, however, an extension of the 4004 design, but instead the culmination of a separate design project at Intel, arising from a contract with Computer Terminals Corporation, of San Antonio TX, for a chip for a terminal they were designing, the Datapoint 2200 – fundamental aspects of the design came not from Intel but from CTC. In 1968, CTC's Austin O. "Gus" Roche developed the original design for the instruction set and operation of the processor. In 1969, CTC contracted two companies, Intel and Texas Instruments, to make a single-chip implementation, known as the CTC 1201. In late 1970 or early 1971, TI dropped out being unable to make a reliable part. In 1970, with Intel yet to deliver the part, CTC opted to use their own implementation in the Datapoint 3300; using traditional TTL logic instead (thus the first machine to run "8008 code" was not in fact a microprocessor at all). Intel's version of the 1201 microprocessor arrived in late 1971, but was too late, slow, and required a number of additional support chips. CTC had no interest in using it. CTC had originally contracted Intel for the chip, and would have owed them \$50,000 for their design work. To avoid paying for a chip they did not want (and could not use), CTC released Intel from their contract and allowed them free use of the design. Intel marketed it as the 8008 in April, 1972, as the world's first 8-bit microprocessor. It was the basis for the famous "Mark-8" computer kit advertised in the magazine Radio-Electronics in 1974.

### 2.3.3 12-bit designs

The Intersil 6100 family consisted of a 12-bit microprocessor (the 6100) and a range of peripheral support and memory ICs. The microprocessor recognised the DEC PDP-8 minicomputer instruction set. As such it was sometimes referred to as the CMOS-PDP8. Since it was also produced by Harris Corporation, it was also known as the Harris HM-6100. By virtue of its CMOS technology and associated benefits, the 6100 was being incorporated into some military designs until the early 1980s.

### 2.3.4 16-bit designs

The first multi-chip 16-bit microprocessor was the National Semiconductor IMP-16, introduced in early 1973. An 8-bit version of the chipset was introduced in 1974 as the IMP-8.

Other early multi-chip 16-bit microprocessors include one that Digital Equipment Corporation (DEC) used in the LSI-11 OEM board set and the packaged PDP 11/03 minicomputer – and the Fairchild Semiconductor MicroFlame 9440, both introduced in 1975-1976. In 1975, National introduced the first 16-bit single-chip microprocessor, the National Semiconductor PACE, which was later followed by an NMOS version, the INS8900.

### 2.3.5 32-bit Designs

Upper interconnect layers on an Intel 80486DX2 die 16-bit designs had only been on the market briefly when 32-bit implementations started to appear.

**Notes**

The most significant of the 32-bit designs is the Motorola MC68000, introduced in 1979. The 68K, as it was widely known, had 32-bit registers in its programming model but used 16-bit internal data paths, 3 16-bit Arithmetic Logic Units, and a 16-bit external data bus (to reduce pin count), and externally supported only 24-bit addresses (internally it worked with full 32 bit addresses). In PC-based IBM-compatible mainframes the MC68000 internal microcode was modified to emulate the 32-bit System/370 IBM mainframe. Motorola generally described it as a 16-bit processor, though it clearly has 32-bit capable architecture. The combination of high performance, large (16 megabytes or 224 bytes) memory space and fairly low cost made it the most popular CPU design of its class. The Apple Lisa and Macintosh designs made use of the 68000, as did a host of other designs in the mid-1980s, including the Atari ST and Commodore Amiga.

**2.3.6 64-bit designs in Personal Computers**

While 64-bit microprocessor designs have been in use in several markets since the early 1990s (including the Nintendo 64 gaming console in 1996), the early 2000s saw the introduction of 64-bit microprocessors targeted at the PC market.

With AMD's introduction of a 64-bit architecture backwards-compatible with x86, x86-64 (also called AMD64), in September 2003, followed by Intel's near fully compatible 64-bit extensions (first called IA-32e or EM64T, later renamed Intel 64), the 64-bit desktop era began. Both versions can run 32-bit legacy applications without any performance penalty as well as new 64-bit software. With operating systems Windows XP x64, Windows Vista x64, Windows 7 x64, Linux, BSD, and Mac OS X that run 64-bit native, the software is also geared to fully utilize the capabilities of such processors. The move to 64 bits is more than just an increase in register size from the IA-32 as it also doubles the number of general-purpose registers.

**Self Assessment**

Fill in the blanks:

- 4. A ..... incorporates the functions of a computer's central processing unit (CPU) on a single integrated circuit (IC), or at most a few integrated circuits.
- 5. Microprocessors operate on numbers and symbols represented in the ..... numeral system.

**2.4 Latest Chipsets and Microprocessors available in Market**

Now we will discuss the latest chipsets and microprocessors available in market.

**Motherboard Asus Rampage II Extreme**

The Rampage II Extreme holds its style well, while proclaiming its leetness simply through the powerful logos plastered on the box; the most prominent of which is the Republic of Gamers logo in the top left corner. Along the bottom, Asus has put the Core i7 logos, the X58 Chipset logo, the Crossfire X logo, and the SLI logo. With that combination of certifications, you know this puppy packs a punch. Of course, you cant miss Asus's own "Rock Solid, Heart Touching" logo in the bottom right. Opening the flap on the front of the box gives you a full frontal of this beast. The top section touts a ton of the exclusive features included on this board, as well as squeezing in some more logos and pictures. When you flip the box over, you are greeted by five captions in many different languages, as well as four pictures showing the "TweakIt" & "ProbeIt" area, the "Extreme Engine" sans heatspreader/ROG LED, a screen shot of the bundled 3DMark Vantage Advanced Edition, and a picture of the SupremeFX X-Fi audio card included with the board.



## Intel® Desktop Board DX58SO

Notes

Today's PC games and compute-intense applications need a computing platform that delivers maximum multi-threaded CPU support and eye-popping graphics support. The Intel® Desktop Board DX58SO is designed to unleash the power of the 32nm Intel® Core™ i7 processor Extreme Edition with six cores and support for up to twelve threads of raw CPU processing power, triple channel DDR3 memory, and full support for ATI CrossfireX\* and NVIDIA SLI\* technology.

## ASUS Rampage III Formula LGA 1366 Intel X58 SATA 6Gb/s USB 3.0 ATX Intel Motherboard

Asus's ROG (Republic of Gamers) series motherboards have an unparalleled reputation within the overclocking community and their Rampage III Formula is the next step. Based on Intel's X58 Express and ICH10R chipsets, this ATX board is ready to host the high-end LGA1366 Core i7 processors for ultimate power performance.

Up to 24GB of DDR3 RAM up to 2200MHz - through overclocking - can be installed in triple channel mode providing increased performance. Enjoy jaw-dropping graphics performance with SLI/CrossFireX on-Demand, and lightning-fast data transfer with Gigabit LAN, True USB 3.0 and SATA 6Gb/s. On-board SupremeFX X-Fi 2 delivers ultra-real cinematic in-game surround sound. Additionally, a bunch of Asus ROG's exclusive features like Extreme Engine Digi+ and ROG Connect help drive your system to the limit.



*Task* Conduct a research and make a report on various Chipsets and Microprocessors available in Market.

## Self Assessment

State True or False:

6. The Rampage II Extreme holds its style well, while proclaiming its leetness simply through the powerful logos plastered on the box
7. Up to 24GB of DDR3 RAM up to 2200MHz - through overclocking - can be installed in triple channel mode providing increased performance.

## 2.5 Basics and Types of Floppy drive/HDD/DVD/RAM etc.

In this section we will discuss the basics and types of Floppy drive/HDD/DVD/RAM/SMPS/BIOS etc.

### 2.5.1 Floppy Drive

A floppy disk drive is a computer component that was designed to read and write to floppy disks that were used for removable storage. A floppy drive stores and retrieves information on floppy disks. A computer can have more than one floppy drive. The first floppy drive is labeled A, and if a second drive is present it is labeled B. The label C is reserved for the hard disk drive, a primary storage unit. The floppy stores information on disks or diskettes magnetically. The disks are removable and reusable.

The most popular type of floppy disk drive is the 3 1/2-inch drive, which is still in limited use today. The floppy disk drive has been replaced by other types of drives such as CD drives, DVD

**Notes**

drives as well as USB flash drives. There are many different types of floppy disk drives that have come and gone over the years.

**Types of Floppy Drives**

The different drive types that have been installed in PC-compatible systems are discussed below:

- **5.25-inch 160/180 KB (SSDD):** Single-Sided, Double-Density (SSDD) was the standard FDD in very early PC-class systems. These drives read and write only SSDD diskettes.
- **5.25-inch 320/360 KB (DSDD):** Double-Sided, Double-Density (DSDD) was the standard FDD in PC-class systems, and was often found as a second FDD in early AT and 386 systems. These drives read and write single-sided (160/180 KB) and double-sided (320/360 KB) formats.
- **5.25-inch 1.2 MB (HD):** High-Density (HD) this and all later formats are double-sided, but that part is no longer stated is the standard FDD in 286, 386, and some early 486 systems, and is often found as a second FDD in early systems with 3.5-inch primary FDDs. These drives read and write any 5.25-inch format. A diskette previously formatted or written to by a 5.25-inch DD drive and then written to by a 5.25-inch HD drive may not subsequently be reliably readable in any 5.25-inch DD drive.
- **3.5-inch 720 KB (DD):** Double-Density (DD) is an interim standard, commonly found as a primary drive in early low-end 286 systems, and as a secondary drive in a few PC-class systems and many 286, 386, and 486 systems. These drives read and write only the 720 KB DD format.
- **3.5-inch 1.44 MB (HD):** High-Density (HD) is the standard FDD on mainstream systems for the past decade. These drives read, write, and format any 3.5-inch HD or DD diskette.
- **3.5-inch 2.88 MB (ED):** Extra-Density (ED) is a failed standard, introduced by IBM and now effectively obsolete. ED diskettes are very expensive typically \$3 each versus \$0.25 for a 1.44 MB diskette which doomed the format. These drives are difficult to find new nowadays, but can read, write, and format any 3.5-inch diskette in any format.

**2.5.2 Hard Disk Drive (HDD)**

A hard disk drive (HDD) is a data storage device used for storing and retrieving digital information using rapidly rotating discs (platters) coated with magnetic material. An HDD retains its data even when powered off. Data is read in a random-access manner, meaning individual blocks of data can be stored or retrieved in any order rather than just sequentially. An HDD consists of one or more rigid (“hard”) rapidly rotating discs (platters) with magnetic heads arranged on a moving actuator arm to read and write data to the surfaces.

Data on a hard disk is stored in microscopic areas called magnetic domains on the magnetic material. Each domain stores either a 1 or 0 value. Similar to a floppy disk, a hard disk records its data in concentric circles or tracks, which are numbered from the outermost edge to the innermost edge of the platter. These tracks are further subdivided into smaller units called sectors which typically store 512 bytes of data each.



*Notes* Zoning may be needed to further optimise the data storage as the outer circumference would normally pack more sector units than the inner circumference.

When a command is made to store some data on a disk, the following chain of events occurs:

Notes

- The data flows into a cache where it is encoded using special mathematically derived formulae, ensuring that any subsequent errors caused by noise can be detected and corrected.
- Free sectors on the disk are selected and the actuator moves the heads over those sectors just prior to writing. (The time it takes the actuator to move to the selected data track is called the “seek” time.)
- Once over the data track, the heads must not write the data until the selected free sectors on that track pass beneath the head. This time is related to the rotation speed of the disk: the faster the speed, the shorter this “latency” period.
- When it’s time to write, a pattern of electrical pulses representing the data pass through a coil in the writing element of the recording head, producing a related pattern of magnetic fields at a gap in the head nearest the disk. These magnetic fields alter the magnetic orientations of bit regions on the disk itself, so the bits now represent the data.

When a command is made to read some data on a disk, a similar process occurs in reverse. After consulting the table of stored data locations in the drive’s electronics, the actuator moves the head over the track where the chosen data is located. When the correct sectors pass beneath the head, the magnetic fields from the bits induce resistivity changes in the sensitive MR or GMR materials located in the reading elements within the head. These elements are connected to electronic circuits, and the current flowing through those circuits change with the resistivity changes. The current variations are then detected and decoded to reveal the data that had been stored on the disk.

### Types of Hard Disk Drives

There are few different types of hard disks, but other than its physical size, the different type of interfaces of the hard disk is main difference.

- **IDE (Integrated Drive Electronics):** IDE drives are also known as PATA drives( Parallel advance technology attachment ). IDE/PATA Drives have usually 40 pins. IDE/PATA Drives offer 133 MB/sec transfer rate.It sends 8 bit data at a time. PATA Cables are used to connect PATA HDD. Two drives can be connected in a single pata cable. One as master and other as slave. The configuration of master and slave is done by different combination of jumpers in the HDD.
- **SATA (Serial advance technology attachment):** Serial Advanced Technology Attachment (SATA) is a version of the ATA interface that uses serial connection architecture. Serial Advanced Technology Attachment is a computer bus interface designed to connect host bus adapters to storage devices such as hard-disk drives and optical drives. Serial Advanced Technology Attachment was designed to replace parallel ATA (Advanced Technology Attachment), also known as EIDE (Enhanced Integrated Drive Electronics).SATA Drives have usually 7 pins, 4 pins in pair of two for sending and receiving data and rest 3 pins are grounded.SATA Drives offers generally 300MB/sec transfer rate.It sends data bit by bit.SATA Cables are used to connect SATA HDD. Only one drive can be connected in a single sata cable.
- **SCSI (Small Computer System Interface):** SCSI is pronounced as scuzzy. SCSI Drives have usually 50 to 68 pins.SCSI Drive offers generally 640MB/sec transfer rate.This drives are hot swappable. SCSI cables are used to connect SCSI HDD. Maximum of 16 drives can be connected in a single scsi cable. Each hdd have a 8 bytes hexadecimal code known as **WWN** (world wide name) for its identification in the cable.

Notes

- **SAS (Serial Attached SCSI):** SAS Drives generally offers 805 MB/sec transfer rate. This drives are hot swappable. SAS Cables are used to connect SAS Drives. Maximum of 128 drives can be connected in a single sas cable.

### 2.5.3 Digital Video Disk (DVD)

A digital video disc (DVD), also known as a digital versatile disc, is an optical disc that stores data and video. Optical discs are circular discs that are read and translated by lasers. DVD is basically CD on steroids. Like a CD, a DVD stores data using tiny pits and lands embossed on a spiral track on an aluminized surface. But where CD-ROM uses a 780 nanometer (nm) infrared laser, DVD uses a 636 nm or 650 nm laser. Shorter wavelengths can resolve smaller pits, which enables pits (and tracks) to be spaced more closely. In conjunction with improved sector formatting, more efficient correction codes, tighter tolerances, and a somewhat larger recording area, this allows a standard DVD disc to store seven times as much data about 700 MB for CD-ROM versus about 4.7 GB for DVD.

#### Types of DVD

There are several types and formats, but most DVDs fall into one of three main categories: read-only, writable, and erasable. It is important to understand the difference between the formats because they are not interchangeable, and each type will only be compatible with specific disc drives. DVD is an optical disc storage format, invented and developed by Philips, Sony, Toshiba, and Panasonic in 1995.



*Did u know?* DVDs offer higher storage capacity than Compact Discs while having the same dimensions.

Pre-recorded DVDs are mass-produced using molding machines that physically stamp data onto the DVD. Such discs are known as DVD-ROM, because data can only be read and not written nor erased. Blank recordable DVD discs (DVD-R and DVD+R) can be recorded once using a DVD recorder and then function as a DVD-ROM. Rewritable DVDs (DVD-RW, DVD+RW, and DVD-RAM) can be recorded and erased multiple times. DVDs are used in DVD-Video consumer digital video format and in DVD-Audio consumer digital audio format, as well as for authoring AVCHD discs. DVDs containing other types of information may be referred to as DVD data discs.

Read-only memory discs are the type of discs that are purchased with media already on them. Movie discs fall under this category. The data and videos on these discs cannot be erased and no data can be added, therefore they are referred to as a non-writable DVD.

The first type of writable DVD was called a random access memory (RAM) disc, but these are no longer compatible with most computers. Now, most computers with writable, or recordable, drives require a DVD-R. This type of disc allows the user to record, or write, information to the DVD. However, information can only be written to the disc one time, and once full the disc becomes read only. This type is the least expensive and most compatible with different drives.

DVD-RWs are another type of DVD. Like the recordable discs, this type is also writable, but it has one more feature. These rewritable discs can be erased and written or recorded as many times as one desires. However, this is an all or nothing option. Partial pieces of information cannot be selected for erasing.



**Caution** The entire disc must be deleted before the user can add new data or media.

DVD+R and DVD+RW are very similar to the DVD-Rs and DVD-RWs. The difference between the -R and the +R is that the +R allows a drag-and-drop files feature and works a bit faster when writing files. The biggest difference between the -RW and the +RW is that the -RW is written in a single layer, whereas the +RW is written in multi-layers. This adds more capacity.

When selecting a DVD format, one should first check to see which formats are compatible with the disc drive intended for use with the DVD. The most expensive types are the discs that are rewritable. If the intent isn't to use the same disc repeatedly, it would be best to get the cheaper write-once format. If one's computer does not have the drive required for the favored format, a new drive can always be swapped out or added.

There is DVD-5, a single-sided and single-layer disc which holds 4.7GB of data; DVD-9, a single-sided and double-layers disc with capacity of 8.5GB; DVD-10, a double-sided and single-layer disc with capacity of 9.4GB; and DVD-18, a double-sided and double-layers disc holds 17GB. The re-writable DVD-RW, DVD+RW and DVD-RAM all had capacity below 3GB when first introduced. However, the latest capacity specification on these discs has approached 4.7GB of a DVD-ROM.

## 2.5.4 RAM

RAM is an abbreviation for Random Access Memory. RAM is the computer's main memory. The computer uses RAM constantly to temporarily store information while it is working with it. Alternatively referred to as main memory, primary memory, or system memory, Random Access Memory (RAM) is a computer storage location that allows information to be stored and accessed quickly from random locations within DRAM on a memory module. Because information is accessed randomly instead of sequentially like a CD or hard drive the computer is able to access the data much faster than it would if it was only reading the hard drive. However, unlike ROM and the hard drive RAM is a volatile memory and requires power in order to keep the data accessible, if power is lost all data contained in memory lost.

Memory, better known as Random Access Memory (RAM) is a set of chips used to store information. These chips can only store information as long as there is electrical power. When the power is turned off, they 'forget' everything and all data is lost. This is because the RAM uses the electricity to store the information. When the electricity dies, so does your data.

Memory comes in a number of configurations for IBM compatible PC's. Memory also comes in parity checking vs. non-parity checking. Parity checking is verifying that there is an even or odd number of 1's or zeroes in the data set. This means that memory that does parity checking is able to verify that it is functioning correctly when running. Most memory sold today is non-parity RAM, and is only checked for errors on start up by writing to and reading from every location in memory.

### Common Ram Types

- **SRAM: Static Random Access Memory** uses multiple transistors, typically four to six for each memory cell, but doesn't have a capacitor in each cell. It is used primarily for cache.
- **DRAM: Dynamic Random Access Memory** has memory cells each with a paired transistor and capacitor, requiring constant refreshing.
- **FPM DRAM: Fast Page Mode Dynamic Random Access Memory** was the original form of DRAM. It waits through the entire process of locating a bit of data by column and row and

Notes

then reading the bit before it starts on the next bit. The maximum transfer rate to L2 cache is approximately 176 MBPS.

- **EDO DRAM: Extended Data-out Dynamic Random Access Memory** does not wait for the entire the processing of the first bit before continuing to the next one. As soon as the address of the first bit is located, EDO DRAM begins looking for the next bit. It is about five percent faster than FPM. The maximum transfer rate to L2 cache is approximately 264 MBPS.
- **SDRAM: Synchronous Dynamic Random Access Memory** takes advantage of the burst mode concept to greatly improve performance. It does this by staying on the row containing the requested bit and moving rapidly through the columns, reading each bit as it goes. The idea is that most of the time the data needed by the CPU will be in sequence. SDRAM is about five percent faster than EDO RAM and is the most common form in desktops today. The maximum transfer rate to L2 cache is approximately 528 MBPS.
- **DDR SDRAM: Double Data Rate Synchronous Dynamic RAM** is just like SDRAM except that it has higher bandwidth, meaning greater speed. The maximum transfer rate to L2 cache is approximately 1,064 MBPS (for DDR SDRAM 133 MHz).
- **RDRAM: Rambus Dynamic Random Access Memory** is a radical departure from the previous DRAM architecture. Designed by Rambus, RDRAM uses a **Rambus In-line Memory Module (RIMM)**, which is similar in size and pin configuration to a standard DIMM. What makes RDRAM so different is its use of a special high-speed data bus called the Rambus channel. RDRAM memory chips work in parallel to achieve a data rate of 800 MHz, or 1,600 MBPS. Since they operate at such high speeds, they generate much more heat than other types of chips. To help dissipate the excess heat Rambus chips are fitted with a heat spreader, which looks like a long thin wafer. Just like there are smaller versions of DIMMs, there are also SO-RIMMs designed for notebook computers.
- **Credit Card Memory:** Credit card memory is a proprietary self-contained DRAM memory module that plugs into a special slot for use in notebook computers.
- **PCMCIA Memory Card:** Another self-contained DRAM module for notebooks, a card of this type is not proprietary and should work with any notebook computer whose system bus matches the memory card's configuration.
- **CMOS RAM:** CMOS RAM is a term for the small amount of memory used by the computer and some other devices to remember things like hard disk settings. This memory uses a small battery to provide it with the power it needs to maintain the memory contents.
- **VRAM: VideoRAM**, also known as MultiPort Dynamic Random Access Memory (MPDRAM), is a type of RAM used specifically for video adapters or 3-D accelerators. The "multiport" part comes from the fact that VRAM normally has two independent access ports instead of one, allowing the CPU and the graphics processor to access the RAM simultaneously. VRAM is located on the graphics card and comes in a variety of formats, many of which are proprietary. The amount of VRAM is a determining factor in the resolution and color depth of the display. VRAM is also used to hold graphics-specific information such as 3-D geometry data and texture maps. True multiport VRAM tends to be expensive, so today, many graphics cards use SGRAM (synchronous graphics RAM) instead. The performance is nearly the same, but SGRAM is cheaper.

## 2.5.5 Switching-Mode Power Supply (SMPS)

Like a linear power supply, the switched mode power supply too converts the available unregulated ac or dc input voltage to a regulated dc output voltage. However in case of SMPS

with input supply drawn from the ac mains, the input voltage is first rectified and filtered using a capacitor at the rectifier output. The unregulated dc voltage across the capacitor is then fed to a high frequency dc-to-dc converter. Most of the dc-to-dc converters used in SMPS circuits have an intermediate high frequency ac conversion stage to facilitate the use of a high frequency transformer for voltage scaling and isolation. In contrast, in linear power supplies with input voltage drawn from ac mains, the mains voltage is first stepped down (and isolated) to the desired magnitude using a mains frequency transformer, followed by rectification and filtering. The high frequency transformer used in a SMPS circuit is much smaller in size and weight compared to the low frequency transformer of the linear power supply circuit.

A switch mode power supply circuit is versatile. It can be used to:

1. step down an unregulated dc input voltage to produce a regulated dc output voltage using a circuit known as Buck Converter or Step-Down SMPS,
2. step up an unregulated dc input voltage to produce a regulated dc output voltage using a circuit known as Boost Converter or Step-Up SMPS,
3. step up or step down an unregulated dc input voltage to produce a regulated dc output voltage,
4. invert the input dc voltage using usually a circuit such as the Cuk converter, and
5. produce multiple dc outputs using a circuit such as the fly-back converter.

A switch mode power supply is a widely used circuit nowadays and it is used in a system such as a computer, television receiver, battery charger etc. The switching frequency is usually above 20 kHz, so that the noise produced by it is above the audio range. It is also used to provide a variable dc voltage to armature of a dc motor in a variable speed drive. It is used in a high-frequency unity-power factor circuit.

The 'Switched Mode Power Supply' owes its name to the dc-to-dc switching converter for conversion from unregulated dc input voltage to regulated dc output voltage. The switch employed is turned 'ON' and 'OFF' (referred as switching) at a high frequency. During 'ON' mode the switch is in saturation mode with negligible voltage drop across the collector and emitter terminals of the switch where as in 'OFF' mode the switch is in cut-off mode with negligible current through the collector and emitter terminals. On the contrary the voltage-regulating switch, in a linear regulator circuit, always remains in the active region.

Details of some popular SMPS circuits, with provisions for incorporating high frequency transformer for voltage scaling and isolation, have been discussed in next few lessons. In this lesson a simplified schematic switching arrangement is described that omits the transformer action. In fact there are several other switched mode dc-to-dc converter circuits that do not use a high frequency transformer. In such SMPS circuits the unregulated input dc voltage is fed to a high frequency voltage chopping circuit such that when the chopping circuit (often called dc to dc chopper) is in ON state, the unregulated voltage is applied to the output circuit that includes the load and some filtering circuit.

When the chopper is in OFF state, zero magnitude of voltage is applied to the output side. The ON and OFF durations are suitably controlled such that the average dc voltage applied to the output circuit equals the desired magnitude of output voltage. The ratio of ON time to cycle time (ON + OFF time) is known as duty ratio of the chopper circuit. A high switching frequency (of the order of 100 KHz) and a fast control over the duty ratio results in application of the desired mean voltage along with ripple voltage of a very high frequency to the output side, consisting of a low pass filter circuit followed by the load. The high frequency ripple in voltage is effectively filtered using small values of filter capacitors and inductors.

Notes

**Types of SMPS**

The different types of SMPSs are discussed below:

- **AT SMPS:** AT stands for Advanced Technology. These are all old SMPSs. They had 12pin power connector, this is called as AT power connector. They were used in Pentium-I, Pentium-MMX, Pentium-II and Pentium-III CPUs. In AT SMPS system we have to manually Shutdown the computer. After giving Shutdown command “It is now safe to turn off your system” message appears then press the power button to shut down.

Figure 2.2: AT SMPS

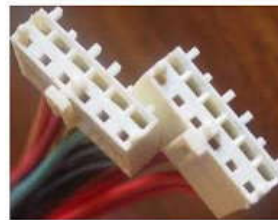

Source: <http://hardwareclasses.blogspot.in/2012/07/smeps-types-and-its-functions.html>

- **ATX SMPS:** ATX stands for Advanced Technology eXtended. They had 20pin Power connector, this is called as ATX power connector. They were used in Pentium-III, Pentium-IV and AMD CPUs. In ATX SMPS shutdown is automatic, that is just give the Shutdown command.

Figure 2.3: ATX SMPS



Source: <http://hardwareclasses.blogspot.in/2012/07/smeps-types-and-its-functions.html>

- **BTX SMPS:** BTX stands for Balanced Technology eXtended. They have 24pin Power connector, this is also called as ATX power connector. It has 15pin SATA power connectors. They are used in Dual core, core2duo, Quad core, i3, i5, i7 and latest AMD CPUs.

Figure 2.4: BTX SMPS



Source: <http://hardwareclasses.blogspot.in/2012/07/smeps-types-and-its-functions.html>



**Self Assessment****Notes**

Fill in the blanks:

11. A ..... is a data storage device used for storing and retrieving digital information using rapidly rotating discs (platters) coated with magnetic material.
12. .... are circular discs that are read and translated by lasers.
13. .... RAM is a term for the small amount of memory used by the computer and some other devices to remember things like hard disk settings.
14. .... RAM is a radical departure from the previous DRAM architecture.
15. .... converts the available unregulated ac or dc input voltage to a regulated dc output voltage.

**2.6 Summary**

- A motherboard is the main printed circuit board (PCB) found in computers and other technological systems.
- The North and South bridges will have different chip names even though they are very often paired with the same opposite bridge to come under the collective name of the chipset.
- A microprocessor incorporates the functions of a computer's central processing unit (CPU) on a single integrated circuit (IC), or at most a few integrated circuits.
- A floppy disk drive is a computer component that was designed to read and write to floppy disks that were used for removable storage.
- A hard disk drive (HDD) is a data storage device used for storing and retrieving digital information using rapidly rotating discs (platters) coated with magnetic material.
- A digital video disc (DVD), also known as a digital versatile disc, is an optical disc that stores data and video.
- Random Access Memory (RAM) is a computer storage location that allows information to be stored and accessed quickly from random locations within DRAM on a memory module.
- The switched mode power supply converts the available unregulated ac or dc input voltage to a regulated dc output voltage.

**2.7 Keywords**

**Chipset:** The chipset is the "glue" that connects the microprocessor to the rest of the motherboard and therefore to the rest of the computer.

**DVD:** A digital video disc (DVD), also known as a digital versatile disc, is an optical disc that stores data and video.

**FDD:** A floppy disk drive (FDD) is a computer component that was designed to read and write to floppy disks that were used for removable storage.

**HDD:** A hard disk drive (HDD) is a data storage device used for storing and retrieving digital information using rapidly rotating discs (platters) coated with magnetic material.

**Microprocessor:** A microprocessor incorporates the functions of a computer's central processing unit (CPU) on a single integrated circuit (IC), or at most a few integrated circuits.

**Notes**

**Motherboard:** A motherboard provides the electrical connections by which the other components of the system communicate.

**RAM:** Random Access Memory (RAM) is a computer storage location that allows information to be stored and accessed quickly from random locations within DRAM on a memory module.

**SMPS:** The switched mode power supply converts the available unregulated ac or dc input voltage to a regulated dc output voltage.

**2.8 Review Questions**

1. What is a motherboard? Discuss the components included in the motherboard.
2. What are the different types of motherboards? Explain.
3. Describe the functions of North Bridge and South Bridge micro-chipsets.
4. Explain the concept of microprocessor.
5. Describe the different types of floppy drives.
6. What is a digital video disc? Also differentiate between -R and +R.
7. Explain the concept of Random Access Memory.
8. Make distinction between FPM DRAM and EDO DRAM.
9. What is Switching-Mode Power Supply (SMPS)? Discuss the uses of SMPS.
10. Describe the different types of SMPS.

**Answers: Self Assessment**

- |                           |                      |
|---------------------------|----------------------|
| 1. motherboard            | 2. Integrated        |
| 3. NLX                    | 4. Chipset           |
| 5. front side bus (FSB)   | 6. memory controller |
| 7. microprocessor         | 8. Binary            |
| 9. True                   | 10. True             |
| 11. hard disk drive (HDD) | 12. Optical discs    |
| 13. CMOS                  | 14. Rambus Dynamic   |
| 15. SMPS                  |                      |

**2.9 Further Readings**



Books

Barrett, Diane. & King, Todd (2005). "Computer networking illuminated." Jones & Bartlett Learning.

Blundell, Barry (2008). "Computer hardware." Cengage Learning EMEA.

Englander, Irv (2003). "The architecture of computer hardware and systems software: An Information Technology Approach." Wiley.

Sarkar, Nurul (2006). *"Tools for Teaching Computer Networking And Hardware Concepts."* Information Science Pub.

Notes

Shinder, Bebra Littlejohn (2001). *"Computer Networking Essentials."* Cisco Press.



Online links

<http://www.howstuffworks.com/motherboard.htm>

<http://www.computerhope.com/jargon/c/chipset.htm>

<http://www.eazynotes.com/notes/microprocessor/Slides/introduction-to-microprocessors.pdf>

<http://www.jjjcom.net/002.php>

Notes

## Unit 3: Assembling of Different Parts of Computers

### CONTENTS

Objectives

Introduction

3.1 Assembling

3.1.1 Safety Tips for Assembling

3.1.2 Components Required to Assemble a Computer

3.2 Handling and Holding Sensitive Equipments

3.2.1 Step 1: Prepare Your Workspace

3.2.2 Step 2: Choosing Computer Cabinet and Cooling Considerations

3.2.3 Step 3: Installing Motherboards

3.2.4 Step 4: Install The Processor (CPU)

3.2.5 Step 5: Install The CPU Heat Sink

3.2.6 Step 6: Install The Memory Modules (Ram Memory)

3.2.7 Step 7: Place The Motherboard Into The Case

3.2.8 Step 8: Connect the Power Supply

3.2.9 Step 9: Install the Graphics/Video Card

3.2.10 Step 10: Connect the Keyboard, Mouse and Monitor

3.2.11 Step 11: Install the Drives

3.2.12 Step 12 : Install the Add-In Cards

3.2.13 Step 13: Turn the Computer On

3.2.14 Step 14: Install the Operating System (OS)

3.2.15 Step 15: Update Drivers

3.2.16 Step 16: Install Anti-Virus Software and Setup a Network/Internet Connection

3.2.17 Step 17: Install other Software

3.3 Summary

3.4 Keywords

3.5 Review Questions

3.6 Further Readings

### Objectives

After studying this unit, you will be able to:

- Recognize the components required to assemble the computer
- Discuss handling and holding sensitive equipments
- Discuss installing motherboards and CPU

## Introduction

Notes

With wide availability of computer towers, cases, motherboards, processors, hard disk, CD or DVD disc drives, and other computer components – and a little bit of technical know-how – you can build your dream computer from scratch. As far as technical skills go, you will need to have a basic aptitude for building computers before you attempt to build your own PC. While bolting together parts is relatively straight forward, you will also need to install an operating system, configure the devices, and make sure that the computer's components are compatible with each other. In this unit, we will discuss the process of building assembling different parts of a computer.

### 3.1 Assembling

If you have decided to take on the task of assembling a computer, it would be better that we spend some time in taking some safety precautions. The safety precautions are extremely important and all of them need to be taken seriously. Here, we will discuss some safety tips and the components needed for assembling.

#### 3.1.1 Safety Tips for Assembling

First of all, since the word is assembling, so definitely, we will be working or dealing with desktop computers in this article. Secondly, our primary focus is the CPU and connecting the different components along with it. Therefore it's obvious that we will discuss the safety precautions that we need to take while assembling the computer cabinet. A static shock which is not sufficient to be felt by humans is enough to destroy the components that you are using to assemble your computer. So, it is very important that all the components that you will be using to assemble your computer should be kept on anti static mats. If in case you do not have anti static mats, you can simply keep them in the packaging in which they came. There is also a concept of using wristbands, while you are using your hands at assembling a computer. The idea is simple, tie the wristband on your wrist and one end of the band is connected to the anti static mat and the other end is connected to the computer chassis. The basic concept is to balance the charge on the computer chassis and the body. Do not stand on a carpet while you are taking up this task.



*Did u know?* Carpets increase the static charge in your body to a great deal.

#### 3.1.2 Components Required to Assemble a Computer

Let us take a look at the components that we will require to assemble a computer.

- The first component that we would require is the computer chassis or cabinet. This is where all the component will be integrated into a package.
- Next we will need the computer motherboard. This is where all the other components need to be connected.
- The computer processor or the CPU (Central Processing Unit) is what handles all the processing of the computer. It is the most important part of a computer.
- RAM or the primary memory of the computer .
- The hard drive of a computer is where all the data is stored. Hence, this is the next component that you will require.

Notes

- A CD/DVD ROM is something that everyone needs. Hence, you should also ensure that you have one of them at least.
- You will also need a non magnetic screw driver to go along with the task of PC assembly.

  
*Task* Make a report on the various components required for assembling different parts of computer.

**Self Assessment**

State True or False:

1. In computer cabinet, all the components will be integrated into a package.
2. All the data is stored in the motherboard.
3. CPU (Central Processing Unit) handles all the processing of the computer.

**3.2 Handling and Holding Sensitive Equipments**

In this sections we will discuss the assembling different components of computers. The steps are discussed as below:

**3.2.1 Step 1: Prepare Your Workspace**

To prepare your workspace:

1. **Take Inventory:** Before you start, take inventory of your parts. Do not begin assembling your computer if you don't have everything you need. Begin the step-by-step process once you have determined you have everything you need.

Figure 3.1: Take Inventory of different computer parts



Source: [http://www.personal.psu.edu/students/r/q/rq15024/published/STEP-BY-STEP-PROCEDURE\\_1.html](http://www.personal.psu.edu/students/r/q/rq15024/published/STEP-BY-STEP-PROCEDURE_1.html)

2. **Make Space, Make Time:** Building a PC take space - about a dining room table worth. So make sure you have plenty of working room and a few hours to proceed with minimal interruption. Work on a flat, stable table top surface or bare floor, where you have room to layout all of the items.
3. **Prepare Grounding Protection:** Use an inexpensive antistatic wrist strap (they are often priced at less than \$6) is the perfect preventive measure if you have no alternative to working on carpet. Remember, a table top or bare floor is always the best place to build your system. Make sure you are wearing your antistatic wrist strap correctly (it does you no good at all if you do not wear it!), and you are ready to proceed.

Figure 3.2: Antistatic wrist strap

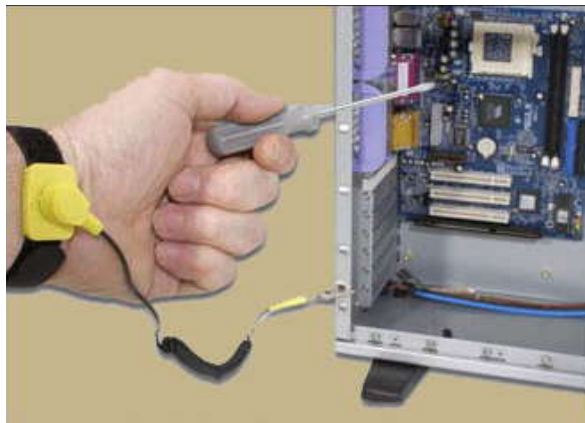

Source: [http://www.personal.psu.edu/students/r/q/rq15024/published/STEP-BY-STEP-PROCEDURE\\_1.html](http://www.personal.psu.edu/students/r/q/rq15024/published/STEP-BY-STEP-PROCEDURE_1.html)

4. **Have the Drivers Ready:** Assuming you have another internet connected PC, download the latest drivers from the vendors' websites for each component you will be installing. Sometimes drivers are updated between the time the component was manufactured and the time you are installing it. It is always best to have the latest. Copy them to a CD for easy access.

### 3.2.2 Step 2: Choosing Computer Cabinet and Cooling Considerations

Computer cabinets are convenient and necessary for storing computers and their accompanying accessories. Whether you need computer cabinets for your office at home or in your workplace, there are a lot of varieties out there. Computer cabinets are helpful because they offer an appropriate area to store computer components as well as files, documents and papers you might have printed out. They help keep your computer space tidy and organized.

#### Considerations

There are a lot of different sizes and shapes of computer cabinets, so people considering purchasing them should be selective in making their decisions. Office decor and the amount of space should be considered. Buying the perfect computer cabinet is vital because a great computer cabinet that can fit everything will make your workplace more efficient, and can even increase your productivity at work.

When you are choosing out a computer cabinet, you should look for one that has the storage space for any additional hard drives you have or might want to acquire in the future. Also, there

Notes

should be enough space for additional devices that you might not always need to use, such as scanners and CD racks.

Desktop PCs and Notebook PCs generate heat that can be damaging to its components. Not just damaging, but heat can actually reduce the performance of your PC - slowing down processing, and causing intermittent errors that can affect your stored data.

Figure 3.3: A Thermograph of a pc board showing hot components

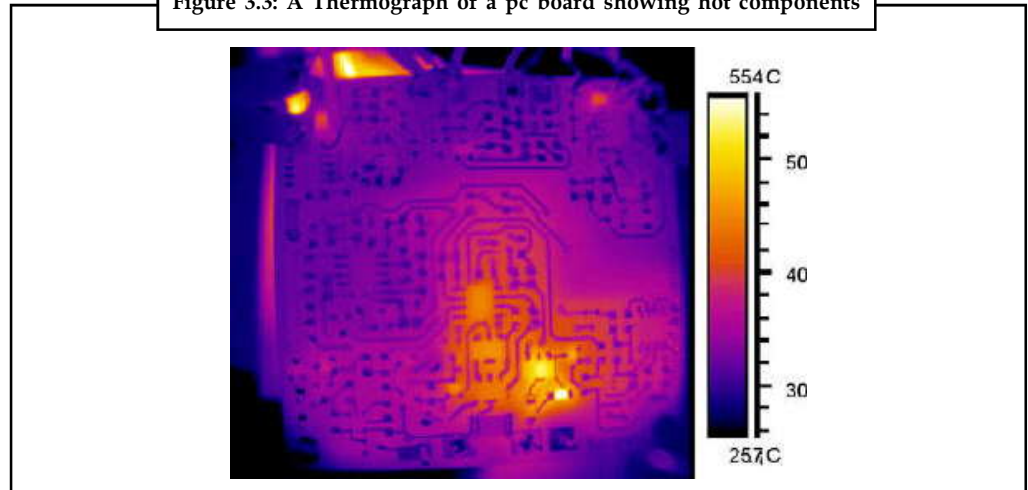

The truth of the matter is, anything that consumes energy generates heat. The power supply, the processor, the graphics card, the hard drives, and all the other components of the computer that require power for it to function generate heat. The amount of heat depends on the device.

For example processors and video cards generate HUGE amounts of heat.

You have probably noticed at one time or another, the big finned heat-sinks (cooling devices) on some of the components inside your computer. These are there to help preserve the useful life of these devices.

It is true that all personal computers, whether they are Desktop PCs or Notebook PCs, come with a cooling system. However, the standard cooling system that comes with your PC may not ultimately be adequate for the PC you now have. Plus, to work efficiently in protecting your PC from overheating and possible damage, several things have to be considered.

- **Air Flow:** PCs are generally air cooled. This means they need lots of air flowing inside them to carry the heat out of their chassis. To keep the internal airflow at maximum there are a few things to watch out for in your desktop computer:
  - ❖ *Keep Cables Neat-* the cables inside your computer can become a block to proper airflow, so be sure they are organized so that they do not restrict airflow.
  - ❖ *Dust-* accumulating dust inside your PC can be deadly. It acts to insulate the devices it covers, keeping heat in, plus dust clogged fans and vents restrict the amount of airflow possible. Keep your PC blown out and dusted regularly.
  - ❖ *Fans-* periodically check your PC's fans to make sure they are working effectively. Fans can fail, resulting in significant reductions in airflow - in some systems a single fan failure can be enough to damage your PC.
  - ❖ *Covers On Tight-* your PC's chassis was designed for proper internal airflow across the various components. However, if your PC's enclosure is open, this then dramatically changes the cooling dynamic. It can reduce or eliminate cooling of some components altogether, so make sure the case's cover in on tight.



- **PC Placement:** We previously mentioned airflow inside the PC, but airflow around the outside is just as important. Blocking the exhaust or intakes can reduce the internal airflow substantially.

Set up your personal computer away from other equipment or appliances that generate heat. Keep your personal computer away from direct sunlight, and make sure that your PC is placed in a well-ventilated area. Placing Desktop PCs and their monitors flat against walls or in enclosed areas should be avoided - leave at least 6 inches of space between the back of the PC and the wall.

Desktop PCs have ventilation fans at the rear of the unit, and depending on its design, may even have ventilation fans on its sides, top, or at the front of the unit. Make sure that these ventilation fans are not blocked in any way as to constrict the airflow that is needed to cool the internal components.

Some people place their Desktop PCs on the floor. While this may save your desk space, having your PC on the floor also makes it more susceptible to dust (and animal hair if you have pets in the house). It is safer to keep your PC off of the floor to minimize foreign matter from entering the computer case. Avoid placing the Desktop PC near drapes as they may end up blocking the ventilation of the computer case as well.

Notebook PCs should not be placed on soft surfaces, such as a bed, couch, or on top of a pillow which can allow the PC to sink into the soft material blocking the ventilation holes needed to circulate air through the computer. Using your Notebook PC on a hard level surface, such as a table is probably the best way to keep your notebook working within its optimal temperature range.

- **Maintenance:** Always make sure to keep your personal computer clean. Cleaning the exterior is not enough. Make sure you know where all the ventilation intake and exhaust openings are, and make sure that these are not obstructed by objects, dust, dirt, foreign matter, or by any of your personal computer's components. If you own a Desktop PC, it would be a good idea to clean the inside of the personal computer at least twice a year. Accumulated dust and lint can clog heat sinks and fans found inside the personal computer. This will result in a drop in cooling efficiency which can lead to the personal computer's components overheating and eventually failing. Heat sinks only work if they are kept clean and are in direct contact with moving air to transfer heat from the heat sink fins to the cooler air around it. You can clean them off using a vacuum cleaner, a blower brush, or a can of compressed air. As a rule, you can use the vacuum on the outside of the PC, and compressed air inside - to minimize the chance of accidental damage to your PC.

If you have a Notebook PC, it would be a good idea to send it in for regular maintenance.



**Caution** A competent computer technician can open up your Notebook PC and make sure that the internal components are kept free of dust and that its fans or heat sinks are clean and functioning to ensure proper air flow, and cooling efficiency.

But at a minimum, use compressed air to keep openings clear of dust. Another tip for notebook owners is to buy a supplemental cooling pad - these contain larger cooling fans that blow upward to help keep your laptop cool.

- **Heat Sinks:** In planning for a cool system, Heat Sinks are the first line of defense. They come in all shapes and sizes, and serve many different components.
  - ❖ **CPU Coolers** - CPUs dies quickly without a heat sink, but the quality and efficiency of the heat sink can have a big impact on performance and system life. Upgrading your CPU cooler is a real life-saver.

Notes

- ❖ *RAM Memory Coolers* - often overlooked, your RAM memory also produces its share of the heat load of your PC, and cool running RAM can also play a role in maintaining the highest level of performance. Few systems come with efficient RAM coolers, yet they are inexpensive and easy to install.
- **Augmented Cooling:** In addition to the regular air cooled components and PC chassis' ventilation fans, there are other options available. Such options include:
  - ❖ *Slot/Bus Card Coolers* - these are fan arrays that plug in and are powered off of the PCI bus connector.
  - ❖ *Video Card Coolers* - supplemental coolers for your video card can improve performance, reduce system internal hot spots, and extend video card life.
  - ❖ *Thermal Electric Component Coolers* - these are basically heat sinks coupled with fans for more efficient cooling.
  - ❖ *Liquid cooled internal radiators* - these use liquid to conduct the heat away from the component to an internal fan driven radiator.
  - ❖ *Liquid cooled external radiators* - these use liquid to conduct the heat away from the component to an external fan driven radiator.



*Task* Analyze different methods to keep the heat away from your system.

### 3.2.3 Step 3: Installing Motherboards

Installing a motherboard in a desktop computer cabinet does not require any special skills. It does require a meticulous attention to detail and the ability to follow step-by-step instructions in the motherboard manual.

The instructions are given as below:

1. Put on a grounding wrist strap. A grounding wrist strap is attached to metal that runs to the ground to prevent static electricity. Static electricity can be damaging to a motherboard, and the damage may show up months later in the form of glitches like freezes or sudden shutdowns.
2. Remove the metallic plate from the case that will be attached to the motherboard. It's easier to mount memory chips and cards when the motherboard is outside the case but near it.
3. Screw the motherboard to the metallic plate. Match up as many of the screw holes as possible in the motherboard to those in the metallic plate. Most of the motherboard holes will have a metal ring around them and are designed to help ground the motherboard. Rubber washers should not be used on these holes. If the motherboard comes with foam backing for protection, the foam should be removed before screwing the motherboard to the plate.
4. Install the proper finishing plate to the case. The finishing plate fits around the sockets on the back of the motherboard. Many motherboards come with a finishing plate that should be used instead of the finishing plate that came with the case.
5. Install the central processing unit, processor cooler and memory cards on the motherboard. Some motherboards are shipped with the processor and cooler already installed. Press these items carefully into their sockets according to instructions in the motherboard manual.

6. Attach the front panel wires. These wires may control the power switch, audio control or ports on the front panel. They usually are attached by pressing them onto pins. Some require the correct polarity, so the negative and positive ends must be attached to the proper terminal.
7. Install the I/O cards for USB ports, audio connectors, networking and other uses. These cards are pressed into card slots at the rear of the motherboard so that their sockets are accessible from outside the case. If the motherboard has DIP switches, these can be set at this time according to the manual's instructions. DIP switches have variable settings for the type of processor and motherboard. Many motherboards use software for these settings instead of switches.
8. Hook up the cables for the power supply and drives. Flat gray cables are used to connect the hard and optical drives to the motherboard. One side of the cable is marked with red and should be connected to the pin marked "No. 1." The drives also may be installed in the case at this time.
9. Attach the motherboard and metallic plate to the case. Screw the I/O brackets down in the back of the case. Connect any cables, such as the power supply cable, that were too short to connect when the motherboard was outside the case.
10. Use ties to organize the cables. Bundling the cables is not just for neatness. It also will improve ventilation in the case and help cool the motherboard and processor.

### 3.2.4 Step 4: Install The Processor (CPU)

1. Use the unlocking mechanism to open the CPU socket which is usually a lever.
2. Carefully line up the pins and place the chip in its socket; it will fit only when oriented the proper way. An arrow or a missing pin on one corner of the chip will show you how to line things up.
3. Align Triangular CPU and socket key marks as shown in Figure 3.4.

Figure 3.4: Install CPU

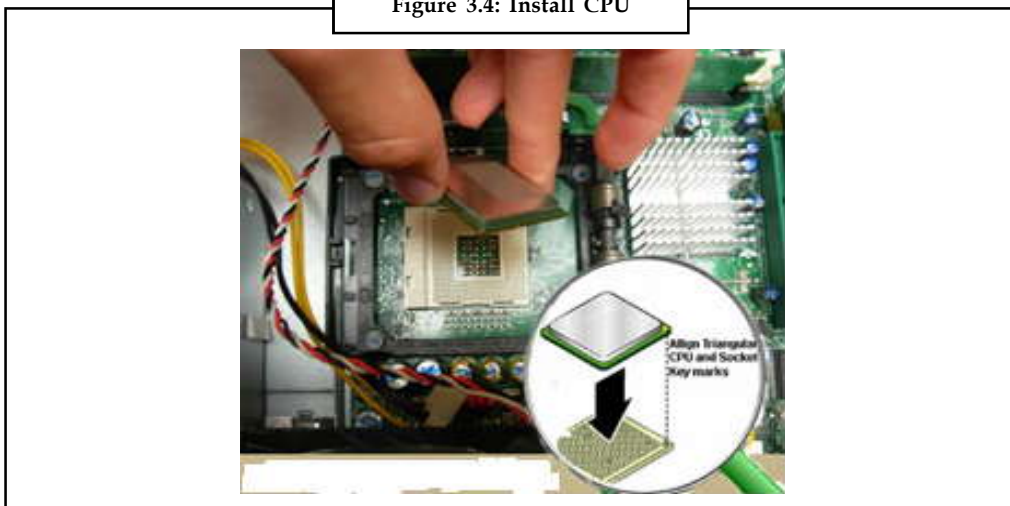

Source: [http://www.personal.psu.edu/students/r/q/rq15024/published/STEP-BY-STEP-PROCEDURE\\_1.html](http://www.personal.psu.edu/students/r/q/rq15024/published/STEP-BY-STEP-PROCEDURE_1.html)

4. Lower the lever to lock the CPU into place.

Notes

### 3.2.5 Step 5: Install The CPU Heat Sink

1. Follow the manufacturer's directions to install the heat sink and the fan that will cool the processor. If you bought a CPU and a separate heat sink, you may need to spread a thin layer of the thermal grease that came with the heat sink over the chip to ensure proper transfer of heat.

Figure 3.5: Install CPU Heat Sink

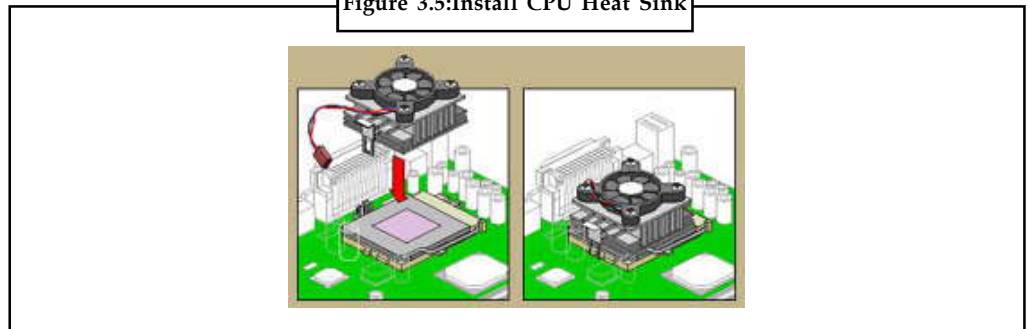

Source: [http://www.personal.psu.edu/students/r/q/rq15024/published/STEP-BY-STEP-PROCEDURE\\_1.html](http://www.personal.psu.edu/students/r/q/rq15024/published/STEP-BY-STEP-PROCEDURE_1.html)

3. Attach the clip that holds the heat sink in place keeping in mind that it may require a fair amount of force. Again, follow the instructions that came with the heat sink. They will show you how to fit it correctly.
4. Plug the CPU fan's power connector into the proper connector on the motherboard.

### 3.2.6 Step 6: Install The Memory Modules (Ram Memory)

In order to install the memory modules, insert them into the proper sockets (Figure 3.6) and push down firmly but evenly until the clips on both sides of the socket pop into place. If your motherboard supports dual-channel memory, consult the user manual to determine which pairs of RAM sockets you should use. The motherboard and the CPU are the brain and nerve center of your PC, so selecting these components is the most important decision you'll make.

Figure 3.6: Install RAM Memory

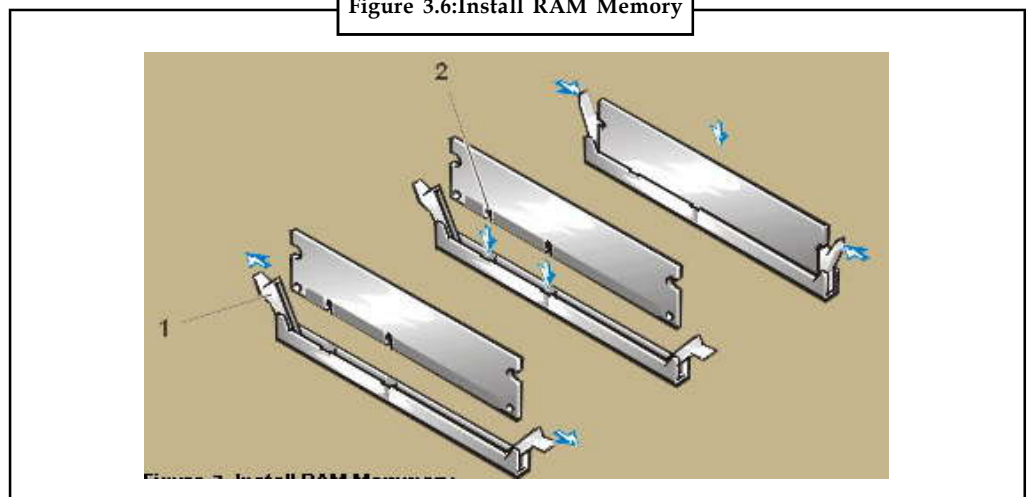

Source: [http://www.personal.psu.edu/students/r/q/rq15024/published/STEP-BY-STEP-PROCEDURE\\_1.html](http://www.personal.psu.edu/students/r/q/rq15024/published/STEP-BY-STEP-PROCEDURE_1.html)

### 3.2.7 Step 7: Place The Motherboard Into The Case

Notes

1. Some PC cases have a removable motherboard tray. If yours does, remove the screws holding it in place and pull it out of the case.

Figure 3.7: Removing Motherboard Tray



Source: [http://www.personal.psu.edu/students/r/q/rq15024/published/STEP-BY-STEP-PROCEDURE\\_1.html](http://www.personal.psu.edu/students/r/q/rq15024/published/STEP-BY-STEP-PROCEDURE_1.html)

2. Note the pattern of the holes in your motherboard, and screw brass standoffs into the motherboard tray or into the PC case in the correct locations (ALWAYS check the manual and follow their instructions to the letter).

Figure 3.8: Screw Brass Standoffs into The Motherboard



Source: [http://www.personal.psu.edu/students/r/q/rq15024/published/STEP-BY-STEP-PROCEDURE\\_1.html](http://www.personal.psu.edu/students/r/q/rq15024/published/STEP-BY-STEP-PROCEDURE_1.html)

3. Check the layout of the sockets on the motherboard, and confirm that the ports on your motherboard's back panel match the holes on the case's Input/Output (I/O) shield that is installed in your case. If necessary, remove the old I/O shield by tapping it firmly a few times with the butt-end of a screwdriver, and then replace it with the shield that came with the new motherboard.

Notes

Figure 3.9: Case's I/O Shield

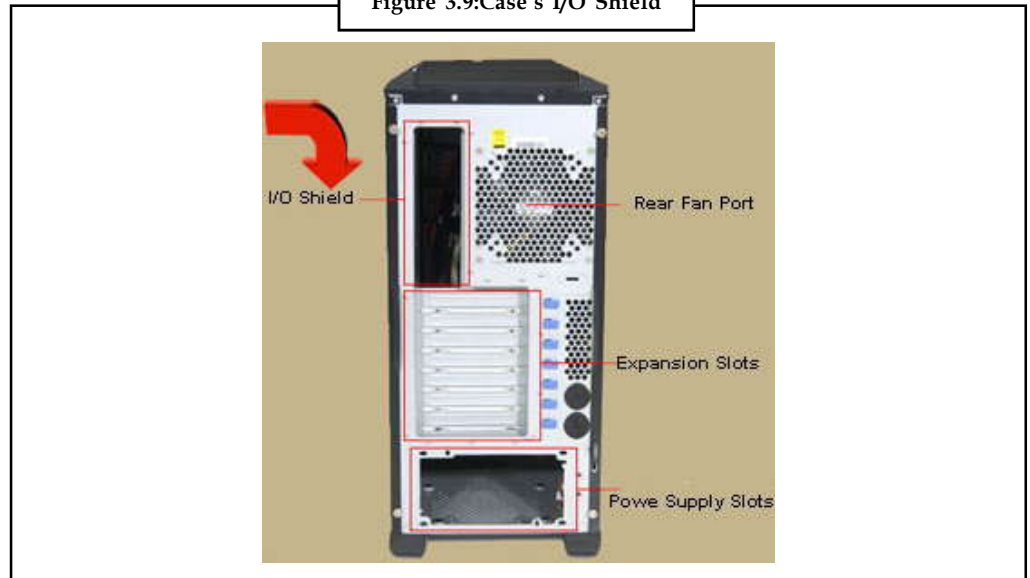

Source: [http://www.personal.psu.edu/students/r/q/rq15024/published/STEP-BY-STEP-PROCEDURE\\_1.html](http://www.personal.psu.edu/students/r/q/rq15024/published/STEP-BY-STEP-PROCEDURE_1.html)

4. Carefully position the motherboard on top of the brass standoffs (Figure 3.10), line up all the holes, and use the screws that accompanied the case to fasten down the motherboard. If you are using a removable tray in your system, slide the tray and motherboard back into the case and then secure the tray.

Figure 3.10: Mount the motherboard



Source: [http://www.personal.psu.edu/students/r/q/rq15024/published/STEP-BY-STEP-PROCEDURE\\_1.html](http://www.personal.psu.edu/students/r/q/rq15024/published/STEP-BY-STEP-PROCEDURE_1.html)

### 3.2.8 Step 8: Connect the Power Supply

Making the proper connections is crucial to successfully assembling your PC system. Fortunately, manufacturers provide color-coded power cables and unique connector shapes to make the job easy.

1. First, plug the large ATX power connector (Figure 3.11 (a)) from your power supply into the matching port on your motherboard.



Figure 3.11: (a) Large ATX Power connector (b)connecting atx power in the motherboard

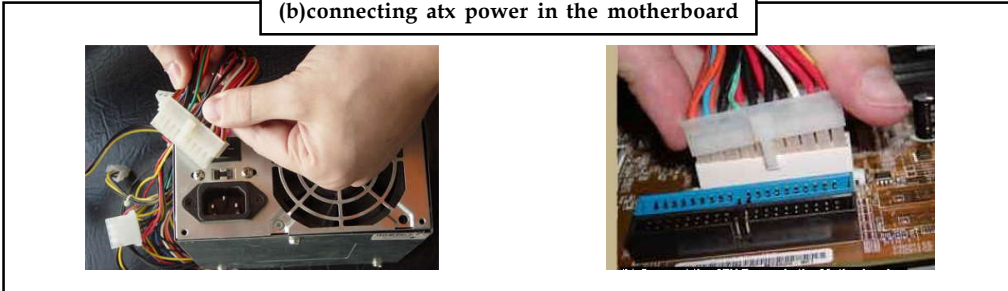

Source: [http://www.personal.psu.edu/students/r/q/rq15024/published/STEP-BY-STEP-PROCEDURE\\_1.html](http://www.personal.psu.edu/students/r/q/rq15024/published/STEP-BY-STEP-PROCEDURE_1.html)

2. Locate the smaller, square processor power connector (Figure 3.12) (you cannot miss it - it is the one sprouting the yellow and black wires) and attach it to the motherboard. Note: your connector is usually located near the processor. As always, refer to your motherboard's manual for the exact locations.

Figure 3.12: Square Processor Power Connector

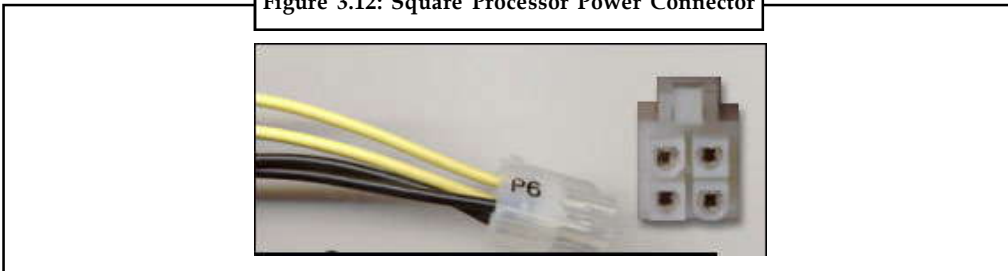

Source: [http://www.personal.psu.edu/students/r/q/rq15024/published/STEP-BY-STEP-PROCEDURE\\_1.html](http://www.personal.psu.edu/students/r/q/rq15024/published/STEP-BY-STEP-PROCEDURE_1.html)

3. Use your motherboard user manual and find the description about front-panel connectors.



*Notes* You are going to be doing work that requires attention to detail and can be quite frustrating if you do not go into it with the right attitude.

4. Attach each of the tiny leads from the power and reset switches (Figure 3.13), the hard-disk activity lights, the PC speaker, and any front-panel USB and FireWire ports to the corresponding pin on your motherboard. The needle-nose pliers are useful for manipulating small pieces.

Figure 3.13: Connecting different leads



Source: [http://www.personal.psu.edu/students/r/q/rq15024/published/STEP-BY-STEP-PROCEDURE\\_1.html](http://www.personal.psu.edu/students/r/q/rq15024/published/STEP-BY-STEP-PROCEDURE_1.html)

Notes

### 3.2.9 Step 9: Install the Graphics/Video Card

1. Begin by removing the backplane cover from the AGP or PCI Express X16 slot (the metal piece where the monitor connector will emerge) (Figure 3.14).

Figure 3.14: Removing Backplane Cover

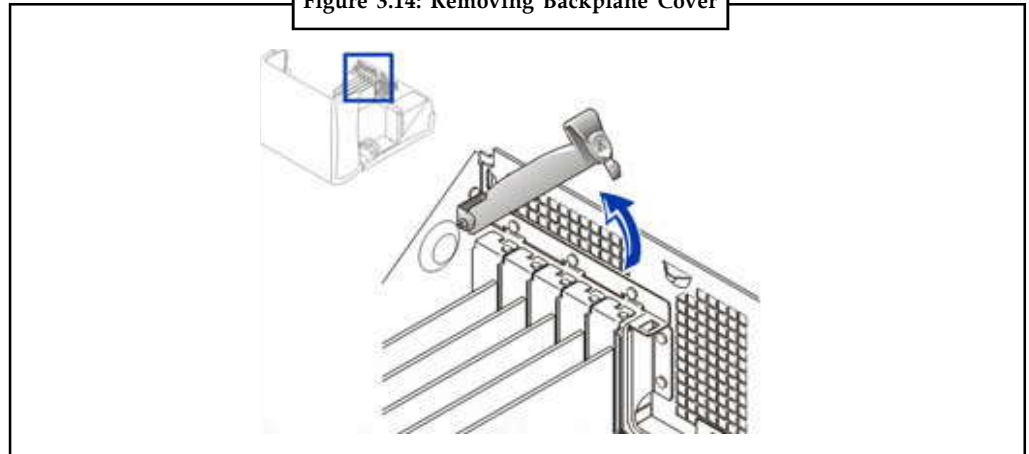

Source: [http://www.personal.psu.edu/students/r/q/rql5024/published/STEP-BY-STEP-PROCEDURE\\_1.html](http://www.personal.psu.edu/students/r/q/rql5024/published/STEP-BY-STEP-PROCEDURE_1.html)

2. Install the graphics board in that slot, and then secure the card with a screw.

Figure 3.15: Installing the Graphics Board

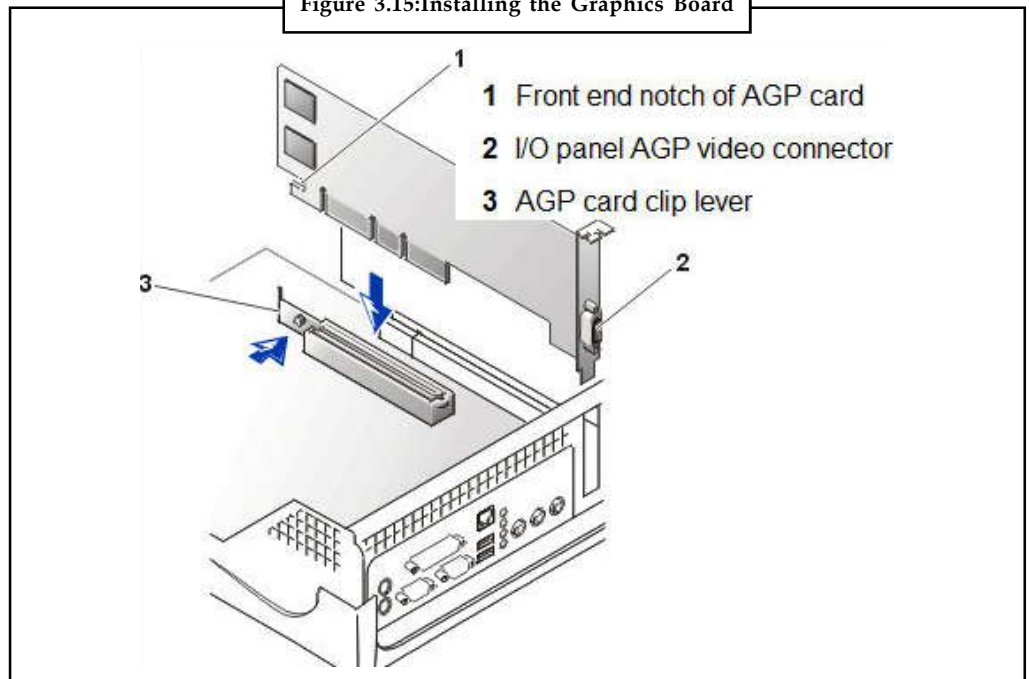

Source: [http://www.personal.psu.edu/students/r/q/rql5024/published/STEP-BY-STEP-PROCEDURE\\_1.html](http://www.personal.psu.edu/students/r/q/rql5024/published/STEP-BY-STEP-PROCEDURE_1.html)

3. Some graphics boards require a dedicated connection to your computer's power supply. If yours does, you should plug in the correct power connector now. Some video cards allow the insertion of a second video card connected to the first. If you purchased such a configuration, install and connect the second video card.



### 3.2.10 Step 10: Connect the Keyboard, Mouse and Monitor

1. Connect a keyboard, mouse, monitor, and power cable to your computer and turn it on.

Figure 3.16: Connecting a Keyboard, Mouse, Monitor and Power Cable

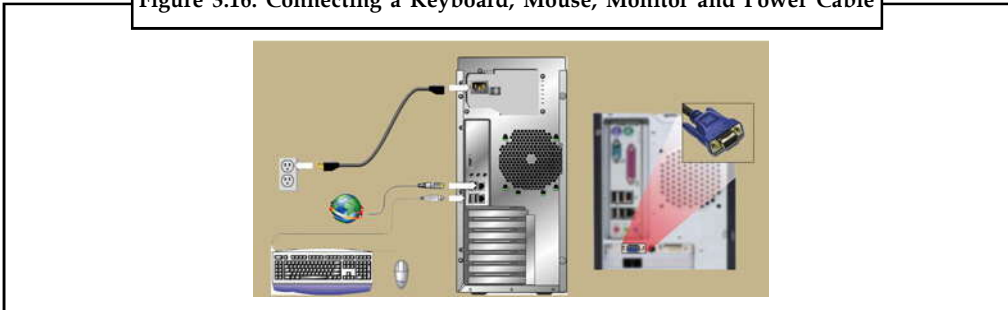

Source: [http://www.personal.psu.edu/students/r/q/rql5024/published/STEP-BY-STEP-PROCEDURE\\_1.html](http://www.personal.psu.edu/students/r/q/rql5024/published/STEP-BY-STEP-PROCEDURE_1.html)

2. If the internal fans begin to whirl, the system beeps, and you see the machine starting to boot, power down by holding the power button for 5 seconds and continue building.
3. If nothing happens, back up a step and recheck all of your connections. Make sure that both the processor and the memory are properly seated, and recheck those minuscule leads connecting the motherboard to the power and reset switches.
4. If it performs as expected, shut down your PC, unplug it, and open the case.

### 3.2.11 Step 11: Install the Drives

Now it is time to install your drives. This is an easy process, but it requires attention to detail.

1. Make any necessary changes to jumpers on the drives before mounting them in the case. A two-drive system is easy to set up.

For example, one or two SATA hard drives, plus one parallel ATA optical drive

Figure 3.17: Hard Drive Pin Setting

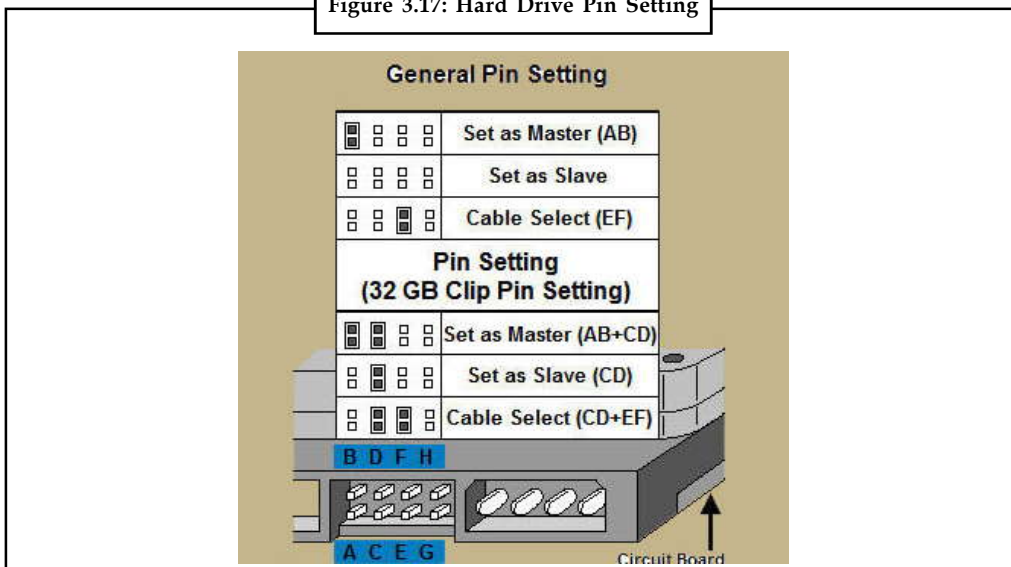

Source: [http://www.personal.psu.edu/students/r/q/rql5024/published/STEP-BY-STEP-PROCEDURE\\_1.html](http://www.personal.psu.edu/students/r/q/rql5024/published/STEP-BY-STEP-PROCEDURE_1.html)

Notes

The SATA drives are jumper less, and the optical drive can be set as master on its own parallel ATA channel. Many cases have removable drive rails or cages to house drives. Figure 3.17 will prove to be of great help.

2. Use the included screws to attach your drives to the rails or cage, and slide them into the case. For externally accessible drives such as a DVD recorder, you can save time by installing one drive rail and sliding the drive in for a test fitting to make sure that its front is flush with the case.

Figure 3.18: Attach Your Drives



Source: [http://www.personal.psu.edu/students/r/q/rql5024/published/STEP-BY-STEP-PROCEDURE\\_1.html](http://www.personal.psu.edu/students/r/q/rql5024/published/STEP-BY-STEP-PROCEDURE_1.html)

3. When the drives are installed, connect power and data cables to each one. Parallel ATA drives use wide, flat data cables that can be installed only in the correct way. Floppy drives use a similar but smaller cable; SATA drives use a thin, 1cm-wide data cable. SATA drives use a new type of power connector that many power supplies don't come with. Fortunately, many motherboards ship with adapters for converting a standard four-pin power connector to a SATA power connector.

Figure 3.19: Connect Power and Data

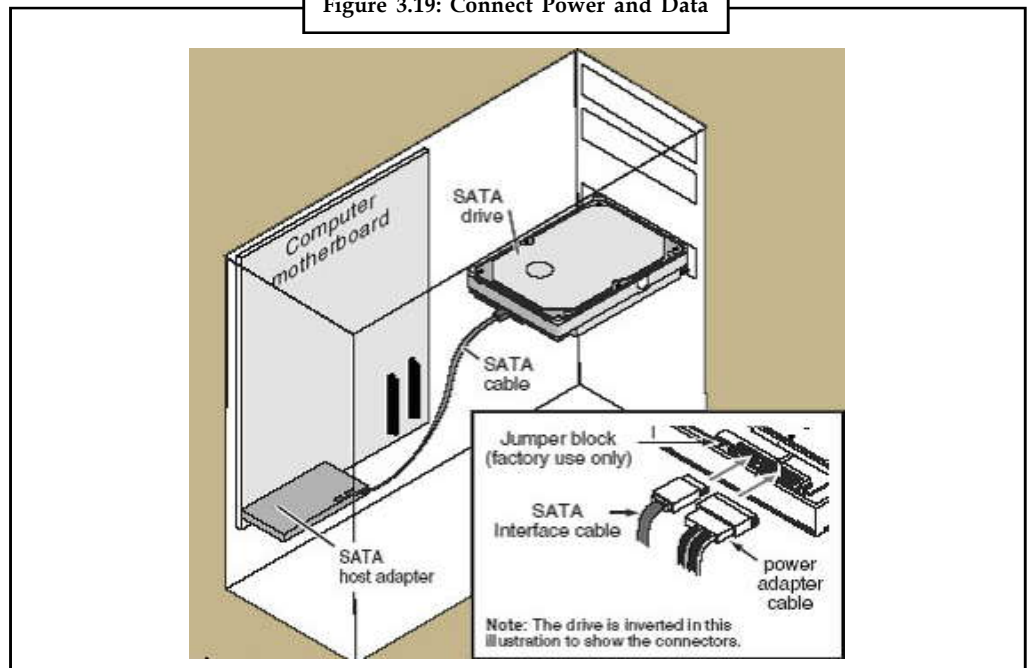

Source: [http://www.personal.psu.edu/students/r/q/rql5024/published/STEP-BY-STEP-PROCEDURE\\_1.html](http://www.personal.psu.edu/students/r/q/rql5024/published/STEP-BY-STEP-PROCEDURE_1.html)



*Caution* The flat, wide ribbon cables that Parallel ATA drives use to carry data can restrict airflow inside your case, robbing your system of valuable cooling; and functionality aside. Rounded data cables available at your local PC store look much nicer, and they don't impede airflow. Please and stage your components carefully.

Some drives ship with both the older connector and the SATA power connector. In that case, use one power connector or the other, but not both. The capacity of hard drives continues to increase: You can now hold over 1TB (Terabyte or 1,000GB) of data on a single drive. But though you don't have to compromise on the drive's size, you still have a few choices to make when picking a hard disks.

### 3.2.12 Step 12 : Install the Add-In Cards

1. For each add-in card, you must choose a free PCI slot.
2. Remove its backplane cover to allow access from the rear of the case.
3. Carefully position the card above the slot, and press down firmly to seat the card (Figure 3.20).
4. Secure the card with a screw.

Figure 3.20: Positioning the Card

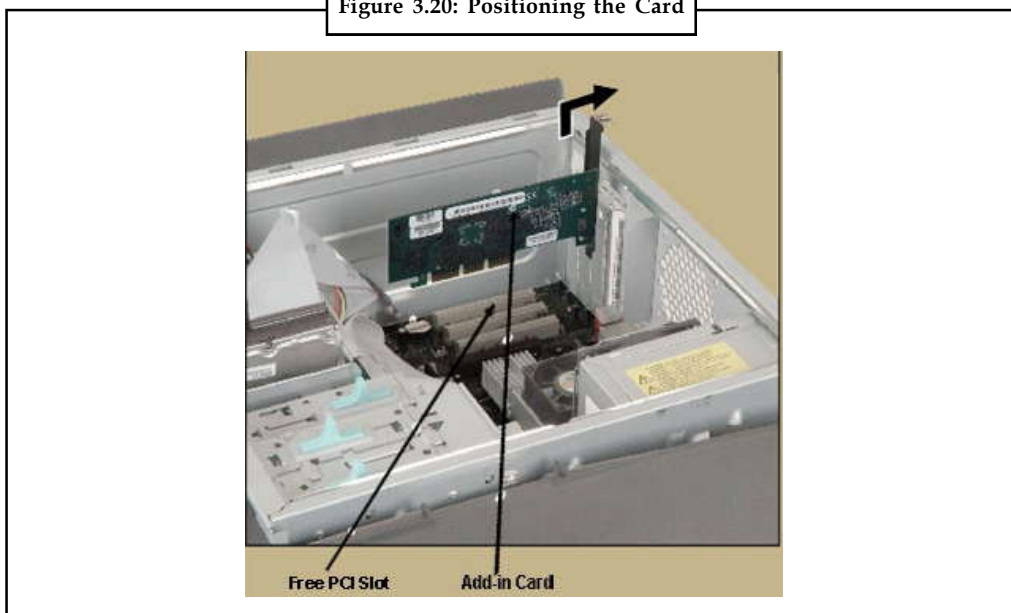

*Source:* [http://www.personal.psu.edu/students/r/q/rql5024/published/STEP-BY-STEP-PROCEDURE\\_1.html](http://www.personal.psu.edu/students/r/q/rql5024/published/STEP-BY-STEP-PROCEDURE_1.html)

Many motherboards have additional sound connectors or ports housed on small add-in boards. Some of these plug into slots on the motherboard; others screw into the back of the case in place of slot covers. Usually the additional ports are not essential to your PC's operation.



*Example:* If you install a sound card, you do not need connectors to the motherboard's built-in sound chip. Check your motherboard manual to determine what each of these boards does.

Notes

### 3.2.13 Step 13: Turn the Computer On

It is time to turn on your system and check your PC set up!

1. Make sure the keyboard, mouse, and monitor are all plugged into the appropriate ports on the back of the PC. Plug the power cord back in, and turn the machine on.

Figure 3.21: Turning the Computer on

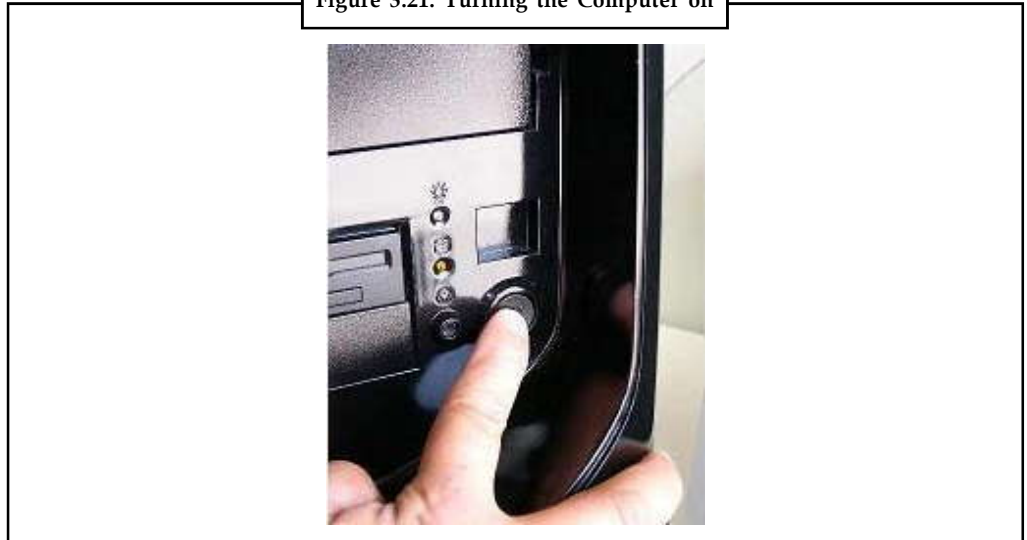

Source: [http://www.personal.psu.edu/students/r/q/rql5024/published/STEP-BY-STEP-PROCEDURE\\_1.html](http://www.personal.psu.edu/students/r/q/rql5024/published/STEP-BY-STEP-PROCEDURE_1.html)

2. When prompted, enter your PC's BIOS setup screen by pressing the indicated key (often Delete) as the machine boots. Menu options (Figure 3.22) will vary from motherboard to motherboard, but they share the same general categories.

Figure 3.22: BIOS Setup

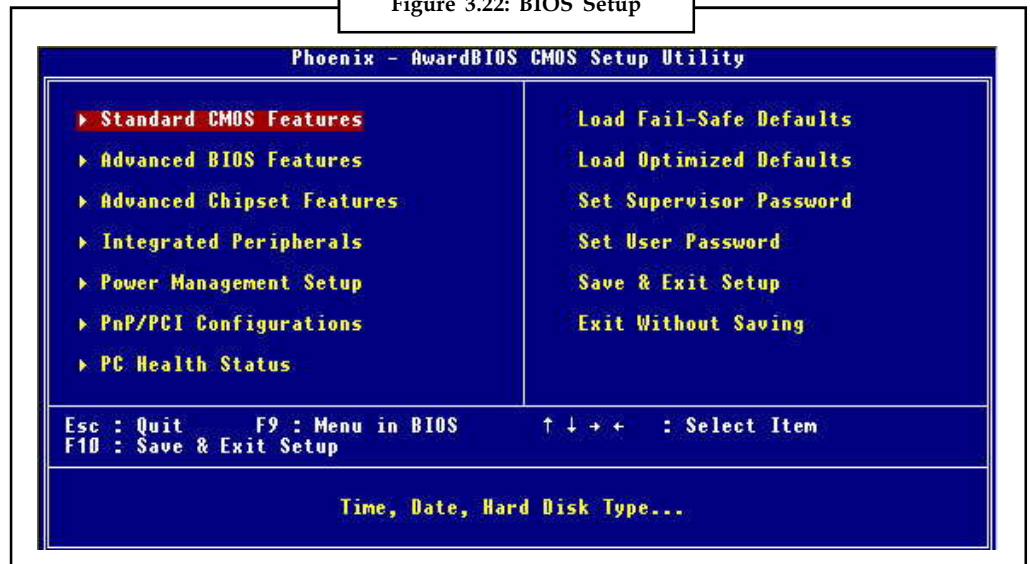

Source: [http://www.personal.psu.edu/students/r/q/rql5024/published/STEP-BY-STEP-PROCEDURE\\_1.html](http://www.personal.psu.edu/students/r/q/rql5024/published/STEP-BY-STEP-PROCEDURE_1.html)

3. Set the date and time.

- Look for a setting that deals with PC health status and monitoring. That choice should bring up a screen showing processor and case temperature. Watch the processor temperature for a few minutes. It should stabilize at a level between 30°C and 50°C. If it keeps increasing, your heat sink probably is not installed properly. Power down and check to see whether the heat sink is securely attached and making good contact with the processor.

Figure 3.23: PC Health Status Setting

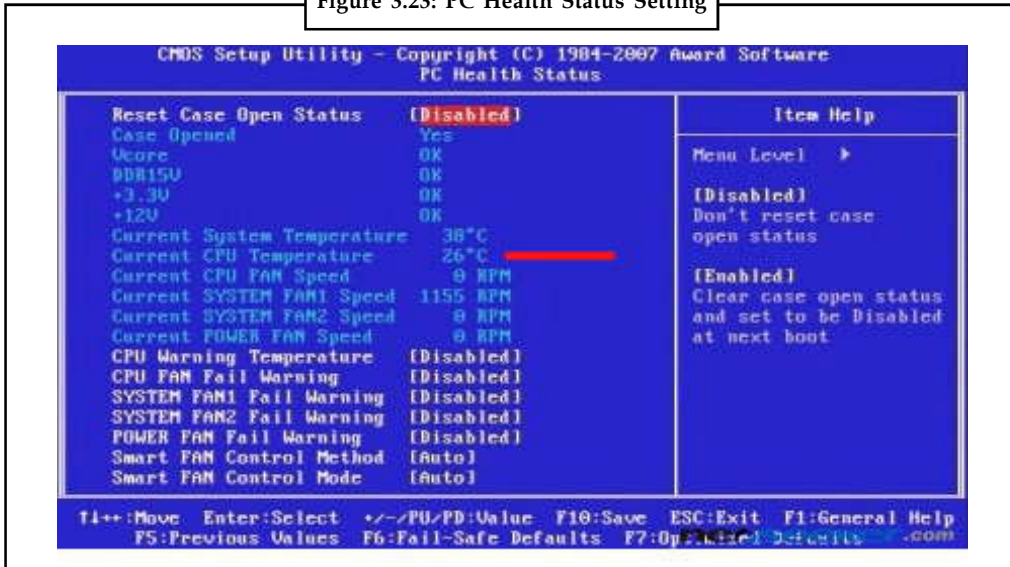

Source: [http://www.personal.psu.edu/students/r/q/rql5024/published/STEP-BY-STEP-PROCEDURE\\_1.html](http://www.personal.psu.edu/students/r/q/rql5024/published/STEP-BY-STEP-PROCEDURE_1.html)

- Next, find the section of the BIOS setup that determines the order in which your machine checks drives and devices for one it can boot from. Set CD-ROM to the highest priority so that your machine will boot from the Windows installation CD.

Figure 3.24: Boot from CD\_ROM

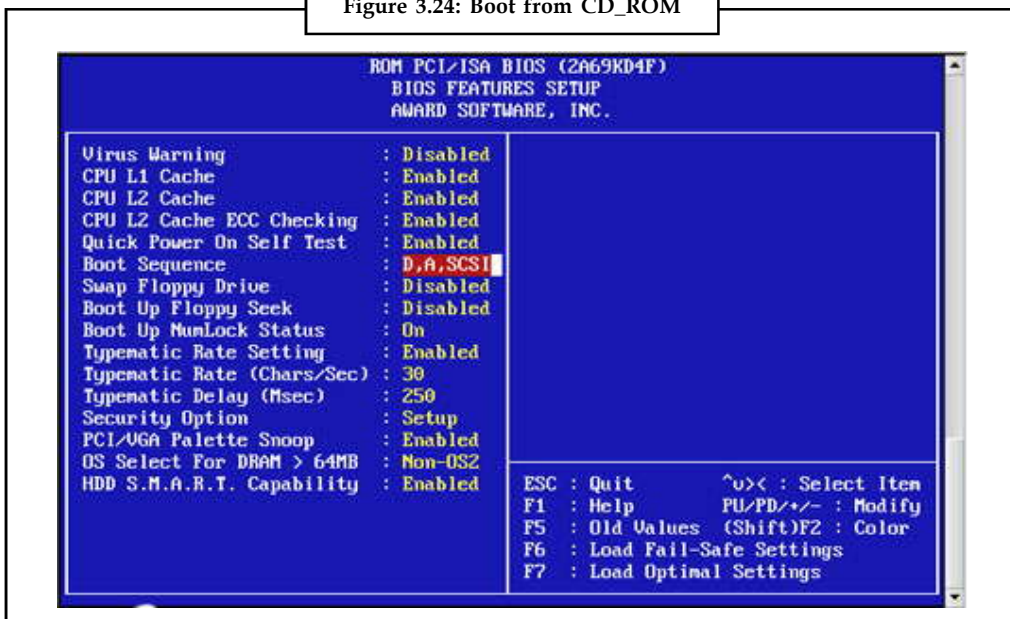

Source: [http://www.personal.psu.edu/students/r/q/rql5024/published/STEP-BY-STEP-PROCEDURE\\_1.html](http://www.personal.psu.edu/students/r/q/rql5024/published/STEP-BY-STEP-PROCEDURE_1.html)



Notes

### 3.2.14 Step 14: Install the Operating System (OS)

You may be “cloning” a PC, and want to copy the same configuration. To do this you would use a “ghosting” tool to create an exact copy of the data from the first PC on the new one. Follow the instructions for the software to perform this operation.



*Did u know?* Some create the clone before the OS is installed, some afterwards.

You are just a couple of steps away from using your new custom-built personal computer. Now you will install the operating system and then update your drivers, and install the different programs.

1. First, place the Operating System installation CD in your optical drive, reboot the PC, and allow the system to boot off the disc (assuming you setup the BIOS to boot from the CD/DVD). The Operating System setup should begin.
2. Early in the process, Windows may ask you whether you need to install a third-party SCSI or RAID driver. If you're using a RAID setup, press F6 when this message appears; then insert the disc containing the appropriate driver when it is requested.



*Notes* If your machine hangs while installing Windows, there may be a problem with one of the components. Try removing everything except the core components (motherboard, processor, one memory module, and hard drives). Then once you have successfully installed Windows, begin reinstalling each component one by one to isolate the source of the problem.

### 3.2.15 Step 15: Update Drivers

Once Windows is up and running, the last step in this process is to update your hardware drivers. This is not an optional procedure.

Figure 3.25: Placing CD in optical drive



*Source:* [http://www.personal.psu.edu/students/r/q/rq15024/published/STEP-BY-STEP-PROCEDURE\\_1.html](http://www.personal.psu.edu/students/r/q/rq15024/published/STEP-BY-STEP-PROCEDURE_1.html)

Insert the CD with the latest drivers (downloaded from the web, or provided otherwise by the manufacturers) and install them starting with the drivers of the motherboard and graphics card and then moving on to the less critical ones (mouse and sound card drivers). Windows comes with basic drivers to get you up and running, but specific or updated drivers are vital. Several reboots later, you should have a fully updated PC!

### 3.2.16 Step 16: Install Anti-Virus Software and Setup a Network/Internet Connection

1. Before you establish an internet connection, you should first install a good antivirus and firewall product for security reasons (CA's is strongly recommended).
2. Download the latest patches of the operating system.

Figure 3.26: Connect to the Internet

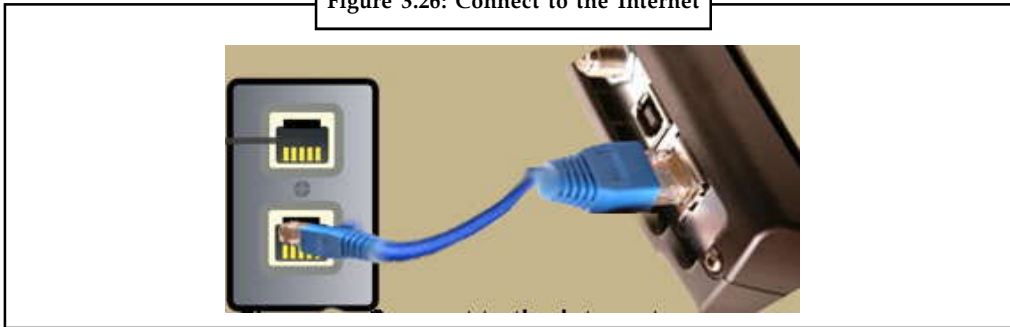

3. Make sure that everything runs smoothly, and then back up your system.
4. Save the hardware configuration under Windows. That way you will have a clean, current image of Windows to go back to if serious trouble arises in the future.
5. Get your network and internet connection up and running. Plug one end of the ethernet cable into the wall jack and the other end of the cable into the ethernet port of your computer. If you are not sure which jack it is, check the motherboard manual. After everything is connected, your setup should resemble Figure 3.26.

### 3.2.17 Step 17: Install other Software

After installing the operating system, you will need to install the software you will be using.



*Example:* Microsoft Office, Adobe Photoshop, Corel Draw, and others.

Some software will require registration or validation, so have the original discs with the software registration or license key ready. After installing the software, you may need to validate the software with the manufacturer or published via the web or by phone. Once this is all done, you are ready to use your new PC!

We have completed all the steps required to make the system completely assembled.

### Self Assessment

Fill in the blanks:

4. Computer ..... are convenient and necessary for storing computers and their accompanying accessories.
5. CPUs dies quickly without a .....
6. .... Coolers are basically heat sinks coupled with fans for more efficient cooling.
7. .... radiators use liquid to conduct the heat away from the component to an external fan driven radiator.

**Notes**

8. .... electricity can be damaging to a motherboard, and the damage may show up months later in the form of glitches.
9. In order to install the memory....., insert them into the proper sockets and push down firmly.
10. The ..... drives are jumper less, and the optical drive can be set as master on its own parallel ATA channel.
11. When the ..... are installed, connect power and data cables to each one.
12. Some software will require, so have the original ..... with the software registration or license key ready.
13. Desktop PCs have ..... fans at the rear of the unit.
14. .... Coolers are fan arrays that plug in and are powered off of the PCI bus connector.
15. The motherboard and the ..... are the brain and nerve center of your PC, so selecting these components is the most important decision..

### **3.3 Summary**

- The basic concept of assembling is to balance the charge on the computer chassis and the body.
- Computer cabinets are convenient and necessary for storing computers and their accompanying accessories.
- There are a lot of different sizes and shapes of computer cabinets, so people considering purchasing them should be selective in making their decisions.
- When you are choosing out a computer cabinet, you should look for one that has the storage space for any additional hard drives you have or might want to acquire in the future.
- In planning for a cool system, Heat Sinks are the first line of defense. They come in all shapes and sizes, and serve many different components.
- In order to install the memory modules, insert them into the proper sockets and push down firmly but evenly until the clips on both sides of the socket pop into place.
- Make any necessary changes to jumpers on the drives before mounting them in the case.
- Many motherboards have additional sound connectors or ports housed on small add-in boards.

### **3.4 Keywords**

**Cabinet:** A computer cabinet is an enclosure with fitted, fixed or removable side panels and doors.

**CPU:** CPU is responsible for handling all instructions it receives from hardware components and software programs running on the computer.

**DVD-ROM:** DVD-ROM, is a media storage disk that closely resembles a CD or compact disc.

**Heat Sink:** A heat sink is an object that disperses heat from another object.



**Motherboard:** A motherboard is the physical arrangement in a computer that contains the computer's basic circuitry and components.

**RAM:** Random Access Memory (RAM) is a computer storage location that allows information to be stored and accessed quickly from random locations within DRAM on a memory module.

**Slot/Bus Card Coolers:** These are fan arrays that plug in and are powered off of the PCI bus connector.

**Video Card Coolers:** These are supplemental coolers for your video card can improve performance, reduce system internal hot spots, and extend video card life.

### 3.5 Review Questions

1. Discuss some safety guidelines that are to be followed while assembling different parts of computer.
2. List the components required to assemble a computer.
3. Why is it important to prepare your workspace before starting assembling.
4. Discuss how to choose a computer cabinet. Also discuss the cooling considerations of computer cabinet.
5. What are Heat Sinks? Discuss.
6. Illustrate the steps used for Installing Motherboards.
7. Discuss the procedure of installing CPU.
8. Explain how to place the Motherboard into the Case.
9. Illustrate how to connect the power supply.
10. Discuss the steps for installing the operating system.

### **Answers: Self Assessment**

- |                           |                               |
|---------------------------|-------------------------------|
| 1. True                   | 2. False                      |
| 3. True                   | 4. Cabinets                   |
| 5. heat sink              | 6. Thermal Electric Component |
| 7. Liquid cooled external | 8. Static                     |
| 9. modules                | 10. SATA                      |
| 11. drives                | 12. Discs                     |
| 13. ventilation           | 14. Slot/Bus Card             |
| 15. CPU                   |                               |

### 3.6 Further Readings



Books

Barrett, Diane. & King, Todd (2005). "Computer networking illuminated." Jones & Bartlett Learning.

Blundell, Barry (2008). "Computer hardware." Cengage Learning EMEA.

**Notes**

Englander, Irv (2003). *"The architecture of computer hardware and systems software: An Information Technology Approach."* Wiley.

Shinder, Bebra Littlejohn (2001). *"Computer Networking Essentials."* Cisco Press.



*Online links*

<http://www.buildacomputer101.com/assembling-your-computer.html>

<http://www.buzzle.com/articles/assembling-a-computer.html>

<http://www.liutilities.com/how-to/assemble-a-computer/>

[http://www.mysuperpc.com/build/pc\\_parts\\_list.shtml](http://www.mysuperpc.com/build/pc_parts_list.shtml)

## Unit 4: Working with Ports and Wires

Notes

### CONTENTS

Objectives

Introduction

4.1 Ports

4.1.1 Port Number

4.2 Computer Wires

4.2.1 Plugging in the Case Fans

4.2.2 Wiring the Front Panel Components

4.2.3 Plugging in the Motherboard Power Connectors

4.3 SATA Slots

4.3.1 SATA Power Cable

4.4 IDE Slots

4.5 Summary

4.6 Keywords

4.7 Review Questions

4.8 Further Readings

### Objectives

After studying this unit, you will be able to:

- Discuss the concept of ports
- Explain the concept of computer wiring
- Discuss SATA slots and IDE slots

### Introduction

Just having a computer itself is not enough. You must have some way to attach external devices. Let's face it, without a monitor, printer, mouse, and keyboard, a computer would be completely worthless. All of the aforementioned devices and a host of others have to connect to a PC or a laptop somehow. Computer ports, normally just called ports, are the physical interfaces that connect these external components. Ports are very important part for a system as they work as interface between your system and other devices that you want to attach with your system. This piece of equipment is easy to found in all the systems as it allows you to plug other devices in it. In this unit, we will discuss the concept of ports. Also we will discuss how to wire up the entire computer.

### 4.1 Ports

A port is a connector at the back of a computer where you plug in an external device.



*Example:* A printer, keyboard, scanner, mouse, modem and many more.

**Notes**

This allows instructions and data to flow between the computer and the device. The computer ports are also commonly referred to as the **Input/Output ports** (I/O ports).

A computer system comes embraced with various inputs and outputs that make it work along with various devices. Even though there are various shapes and sizes available in ports, the primary role revolves around share of information.

When you connect a new device with help of any of the port then signals starts flowing through system to device and your device start working with your system, according to your commands.

Ports are categorized in terms of process, function and connectivity. In the following set of statements, we will identify different type of ports.

The different types of ports are discussed below:

- **Serial ports:** Serial ports are a type of computer interface that complies with the RS-232 standard. They are 9-pin connectors that relay information, incoming or outgoing, one byte at a time. Each byte is broken up into a *series* of eight bits, hence the term *serial* port.

These ports are one of the oldest types of interface standards. Before internal modems became commonplace, external modems were connected to computers via serial ports, also known as communication or “COM” ports. Computer mice and even keyboards also used them. Some used 25-pin connectors, but the 9-pin variety was more common. They are controlled by a special chip call a UART (Universal Asynchronous Receiver Transmitter).

Serial ports differ from 25-pin parallel ports in that the parallel ports transmit one byte at a time by using eight parallel wires that each carry one bit. With data traveling in parallel, the transfer rate was greater.



*Did u know?* A parallel port could support rates up to 100 kilobytes per second, while serial ports only supported 115 kilobits per second (kbps). Later, enhanced technology pushed serial speeds to 460 kbps.

- **Parallel ports:** Parallel port is widely referred as female port in the world of computers. Parallel ports have always been discovered to be faster. With the capacity to transfer 8 bits per second, it is widely in use. Parallel port is used for data transfer between a computer and a peripheral device through a 25 or 36 pin connector. If the serial port transferred data one bit at a time in parallel communication multiple bits are transferred at a time. By using the IEEE 1284 standard the parallel port becomes a bidirectional data gateway (can be used for transferring and receiving data packages).

The parallel port speed can range from 50 KBps to 150 KBps for SPP and BPP systems and can go up to 2 MBps for EPP and ECP systems. The 2 MBps speed is achieved when the EPP and ECP modes are used as a 32 or 16 bit transfer interface who uses a 8 bit IN / OUT hardware.

- **SCSI ports:** Small computer system interface port is the port that helps in connectivity of additional systems to the computer. Short for **Small Computer System Interface, SCSI**, pronounced as “*Scuzzy*”, is the second most commonly used interface for disk drives that was first completed in 1982. Unlike competing standards, SCSI is capable of supporting eight devices, or sixteen devices with Wide SCSI. However, with the SCSI host adapter located on ID number 07 and boots from the ID 00. This leaves the availability of six device connections.
  - ❖ SCSI-1 is the original SCSI standard developed back in 1986 as ANSI X3.131-1986. SCSI-1 is capable of transferring up to eight bits a second.

- ❖ SCSI-2 was approved in 1990, added new features such as Fast and Wide SCSI, and support for additional devices.
- ❖ SCSI-3 was approved in 1996 as ANSI X3.270-1996.

SCSI is a standard for parallel interfaces that transfers information at a rate of eight bits per second and faster, which is faster than the average parallel interface. SCSI-2 and above supports up to seven peripheral devices, such as a hard drive, CD-ROM, and scanner, that can attach to a single SCSI port on a system's bus. SCSI ports were designed for Apple Macintosh and Unix computers, but also can be used with PCs. Although SCSI has been popular in the past many users are switching over to SATA drives.

- **MIDI ports:** Musical Instrument Digital Interface (MIDI) is a standard for digitally representing and transmitting sounds that was first developed in the 1980s. The MIDI sound is played back through the hardware device or computer either through a synthesized audio sound or a waveform stored on the hardware device or computer. The quality of how MIDI sounds when played back by the hardware device or computer depends upon that device's capability.

Many older computer sound cards will have a MIDI port, as shown in the figure below. This port allows musical instrument devices to be connected to the computer, such as a MIDI keyboard or a synthesizer. Before connecting any of these devices to the computer, you will need to purchase a separate cable, which takes the MIDI/Game port connection into the standard 5-pin DIN midi connector or a USB to MIDI converter. If you do not have a MIDI port, the most common way today to connect a MIDI device to a computer is to use a USB to MIDI port cable.

Figure 4.1: MIDI/Game Port and MIDI Keyboard



Source: <http://www.computerhope.com/jargon/m/midi.htm>

- **PS/2 port:** PS/2 port is Often referred to as the **mouse port** or **keyboard port**. That is, it is the inlet to a computer to which mouse and keyboards are connected. They are serial ports to which transfer of information takes place. The older version of system have PS/2 ports for sure however the newer version of computer systems come up with USB keyboard or mouse. There are even operating systems that come up with wireless connectivity.

The **PS/2 port** is used to connect a computer mouse or keyboard to an IBM compatible computer. The PS/2 port is a mini DIN plug that contains six pins and is still found on all IBM compatible computers today, however, is starting to be replaced by USB.

In the figure given below, are two pictures of what the PS/2 ports look like on the back of your computer. As can be seen by both of these pictures many computers have adopted the color codes purple and teal as identifications for each of the port. The mouse is teal and the keyboard is purple.

Notes

Figure 4.2:PS/2 ports

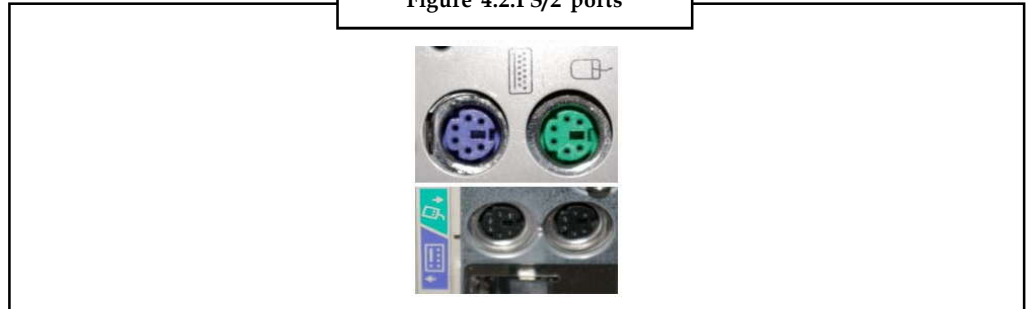

Source: <http://www.computerhope.com/jargon/p/ps2.htm>

- **VGA port:** The video graphics array port is the port that transfers images and information from the system tower to the monitor. Ideally motherboard is mounted with video card. To make the video card communicate and bring output on the monitor, VGA port is available at the back of the system. The VGA port is a serial port that communicates with the system using fifteen pins.
- **USB port:** A USB port is a standard cable connection interface on personal computers and consumer electronics. USB ports allow stand-alone electronic devices to be connected via cables to a computer (or to each other).

USB stands for Universal Serial Bus, an industry standard for short-distance digital data communications. USB allows data to be transferred between devices. USB ports can also supply electric power across the cable to devices without their own power source.

Both wired and wireless versions of the USB standard exist, although only the wired version involves USB ports and cables.

Just about any computer that you buy today comes with one or more **Universal Serial Bus** connectors. These USB connectors let you attach mice, printers and other accessories to your computer quickly and easily. The operating system supports USB as well, so the installation of the device drivers is quick and easy, too. Compared to other ways of connecting devices to your computer (including parallel ports, serial ports and special cards that you install inside the computer's case), USB devices are incredibly simple.

- **Ethernet port:** Ethernet port is a port connection that allows a computer to connect to a network using a wired connection. Ethernet port is widely used as a network port, it helps in making the system a part of the network. The range of transfer of speed is between 10 to 1000 megabits per second.



*Example:* The figure given below is a close up example of what an ethernet port looks like for a network cable using a RJ-45 connector. In the case of this example, the two led lights will blink when that port is active and receiving activity.

Figure 4.3: Ethernet Port

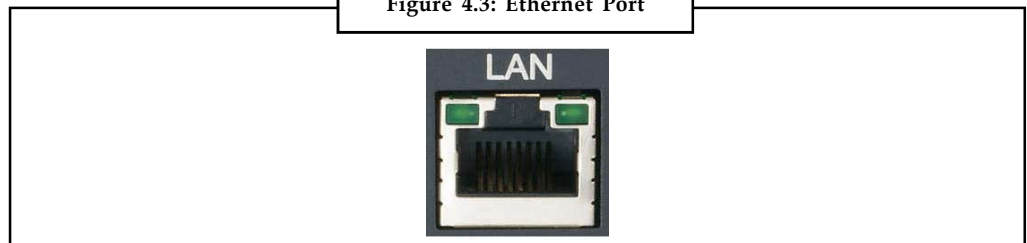

Source: <http://www.computerhope.com/jargon/l/lanport.htm>

- **DVI port:** DVI (Digital Visual Interface) is a specification created by the Digital Display Working Group (DDWG) to accommodate analog and digital monitors with a single connector.

DVI port is the digital video interface port that offers advanced and enhanced quality of video output. The newer versions of computer systems are loaded with video cards and DVI ports.

There are three different DVI configurations: DVI-A, designed for analog signals, DVI-D, designed for digital signals, and DVI-I (integrated), designed for both analog and digital signals. Using a DVI port, a digital signal that is sent to an analog monitor is converted into an analog signal.



**Caution** If the monitor is a digital monitor, such as a flat panel display, no conversion is necessary.

Many monitors now include a DVI connection and many video adapters include a DVI port along with, or instead of, the traditional 15-pin Video Graphics Array (VGA) port.

#### 4.1.1 Port Number

A port number is a way to identify a specific process to which an Internet or other network message is to be forwarded when it arrives at a server. A port number is a unique number which are used to identify network applications. Consider an analogy where, a person calls up an organization on the board telephone number, which is a unique number. Once the call is established, the automatic calling system would request the caller to enter the extension number to reach the required person. In networking, the board number and the extension number corresponds to IP address and port number.

The port number is a 16 bit binary number in the TCP. Therefore the port number is in the range of 0-65535. The port numbers are divided into three ranges.

- Well Known ports.
- Registered Ports.
- Dynamic Ports/Ephemeral ports

#### Well known Ports

The port numbers ranging from 0-1023. They are assigned to standard server processes such as FTP, Telnet. The numbers are assigned by IANA

Table 4.1: Port Numbers

Port	Protocol	Description
7	Echo	Echoes a received datagram back to the sender.
9	Discard	Discards any datagram that is received
11	Users	Active user
13	Daytime	Returns the data and the time
17	Quote	Returns a quote of the day

Contd....

Notes

19	Charge	Returns a string of characters
20	FTP, Data	File Transfer Protocol(data connection)
21	FTP, Control	File Transfer Protocol(Control connection)
23	TELNET	Terminal Network
25	SMTO	Simple Mail Transfer Protocol
53	DNS	Domain Name Server
67	BOOTP	Bootstrap Protocol
79	Finger	Finger
80	HTTP	Hypertext Transfer Protocol
111	RPC	Remote Procedure Call

**Registered Ports**

The ports ranging from 1024 - 49151 are to be registered with IANA to prevent duplicating. They can be used for proprietary server processors or nay client process.

**Dynamic Ports**

The ports numbers from 49152 - 65535 are dynamic or ephemeral ports. It can be frequently used. Normally they are used by client process temporarily. The client process need not have a fixed port number.



*Example:* A client can access the server with client port number 50000. after terminating that connection, if the client need to make a connection with server again, the second time client can arbitrarily select port number 65004.



*Task* Compare and contrast Registered ports and Dynamic ports.

**Self Assessment**

Fill in the blanks:

1. A ..... is a connector at the back of a computer where you plug in an external device such as a printer, keyboard, scanner, mouse, modem and many more.
2. .... port is the port that helps in connectivity of additional systems to the computer.
3. .... port is Often referred to as the mouse port or keyboard port.
4. A ..... port is a standard cable connection interface on personal computers and consumer electronics.
5. .... port is the digital video interface port that offers advanced and enhanced quality of video output.
6. A ..... is a way to identify a specific process to which an Internet or other network message is to be forwarded when it arrives at a server.



## 4.2 Computer Wires

Notes

Once everything is in place, you will want to wire up the entire computer, the best way to do this is to start from the most out of reach cables to the most easily accessed cables. This allows for easier assembly and better cable management which then allows for lower system maintenance overall.

### 4.2.1 Plugging in the Case Fans

The smallest cables in this system belong to the case fans. Plugging them in is exactly the same as plugging in the CPU fan. Simply line up the pins and line up the key with its guide and insert the plug into the pins.

Figure 4.4: Plugging Cables in Case Fan

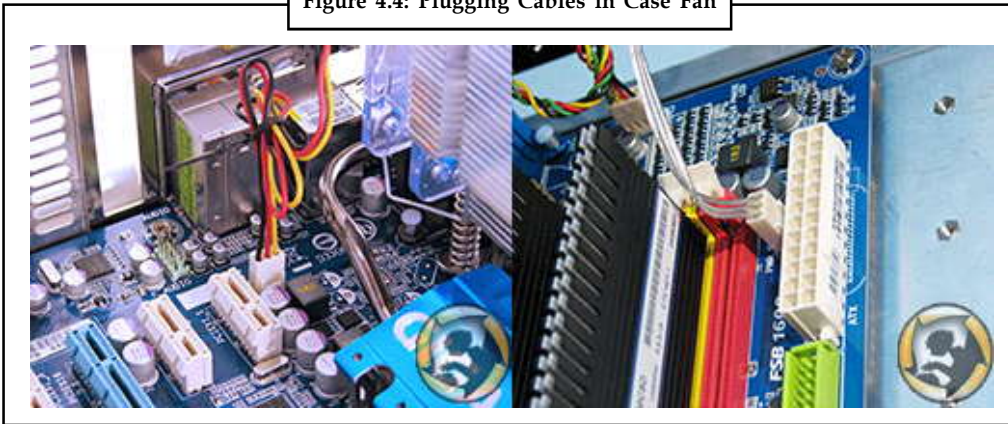

Source: <http://www.hardwareheaven.com/articles.php?articleid=132&pageid=10>

If your motherboard isn't equipped with a sufficient number of fan headers you may want to invest in a few Molex to 3 pin power adaptors. These can be found at most computer hardware retailers but can also come bundled with fans and cases.

### 4.2.2 Wiring the Front Panel Components

The series of cables that can be found loose inside the chassis are used for connecting the front panel components. A number of the cable headers are carry labels such as USB and 1394, these provide functionality to the front ports. There is also a smaller set of cables, usually with a multitude of colour coded wires, these are for the indicator lights as well as the Power and Reset switches.

Figure 4.5: Series of Cables

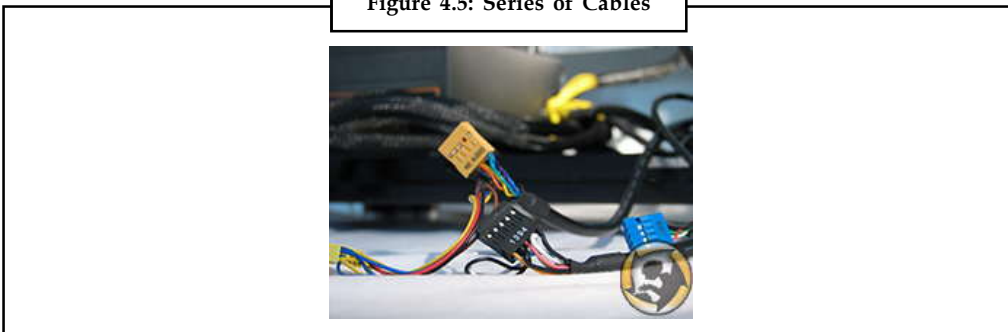

Source: <http://www.hardwareheaven.com/articles.php?articleid=132&pageid=10>

Notes

To wire these properly, you will need to look at the motherboard's manual to figure out the pin-outs for the motherboard front panel headers.

 Notes Asus, Gigabyte and MSI provide components to help make case wiring easier. Some motherboard manuals aren't clear enough about the positive or negative lead for certain functions so it is a bit of trial and error when it comes to wiring the indicator lights, you will not damage anything if the connectors happen to be inserted wrong way round the first time.

Figure 4.6: Cables Connecting the Front Panel Components



Source: <http://www.hardwareheaven.com/articles.php?articleid=132&pageid=10>

For those of you using on-board audio, the method for installing the front panel audio jacks is the same as the other ports, there is an appropriate header located on the motherboard. However, if you have installed an aftermarket sound card you will want to connect the front panel to your device in order to provide full functionality.

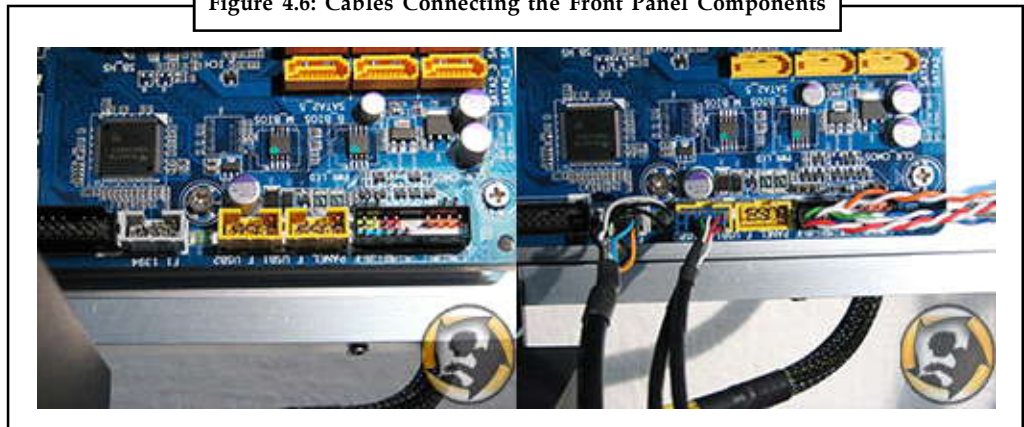
Figure 4.7: Locating the Connector

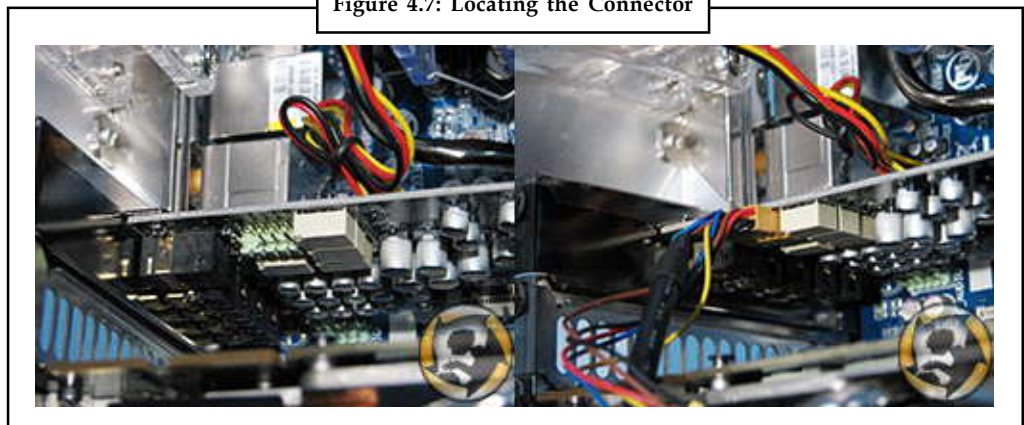

Source: <http://www.hardwareheaven.com/articles.php?articleid=132&pageid=10>

Locate the connector shown above on your sound card and simply connect the audio cable from the front panel. All of the front panel connectors are keyed, so they will only fit the matching port. If you find yourself having to apply force, you're most likely attempting to connect a cable in the wrong location.

You have just wired the front panel components, for now, move on until you finish the system to test the front panel. If it turns out that one of the indicator lights does not work properly, turn the plug around, refit and try again.

### 4.2.3 Plugging in the Motherboard Power Connectors

The first connector you will want to connect would be the 24-pin main power connector.

The actual name for the connector below is a 20+4 pin connector, simply because the main connector is a 20-pin and the extra 4-pin connector is plugged into the other 4 pins of a motherboard 24-pin header.

Figure 4.8: Plugging in the Motherboard Power Connectors

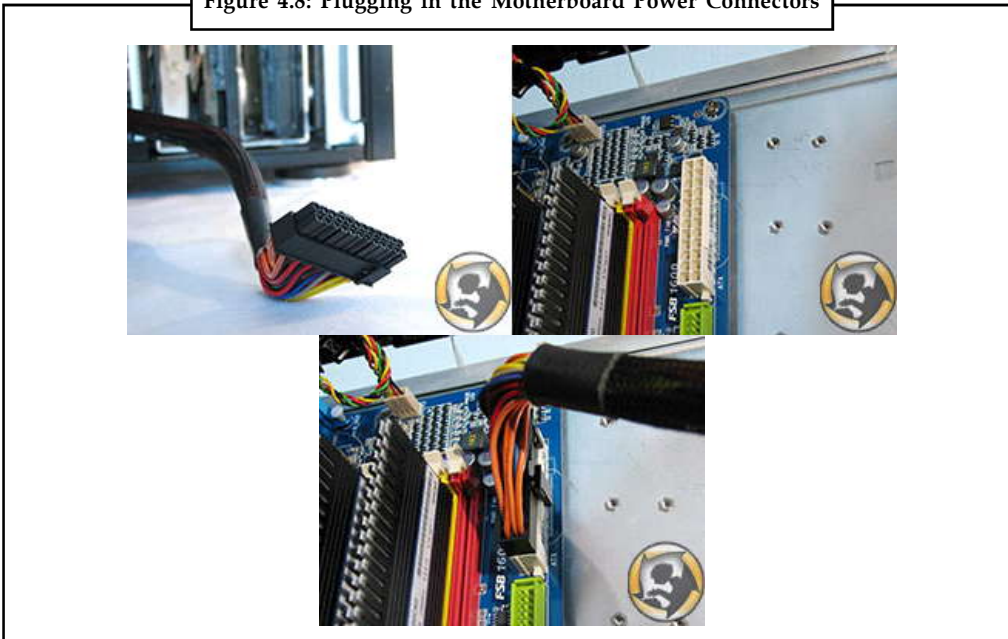

Source: <http://www.hardwareheaven.com/articles.php?articleid=132&pageid=10>

Simply align all 24 pins of the connector into the header and push down. Be sure to have the latch locked down as these cables tend to come out.

The next connector will be the 8-pin power connector. Same drill as before, align the pins and insert into header until it locks down. This connector is found next to your CPU socket.

Figure 4.9: the 8-pin Power Connector

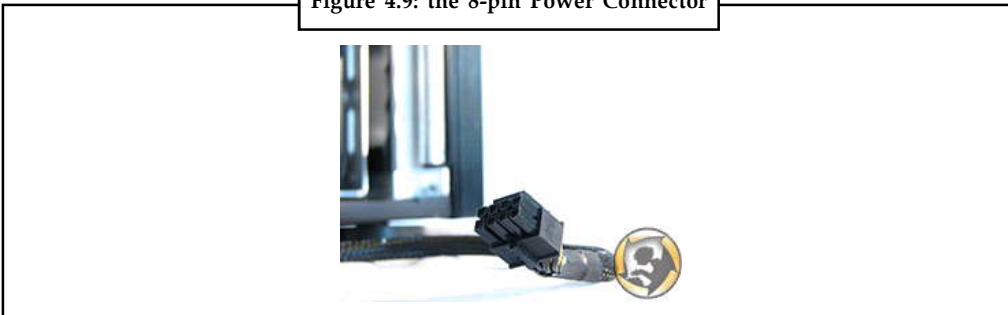

Source: <http://www.hardwareheaven.com/articles.php?articleid=132&pageid=10>

Your motherboard now has power, next would be powering the SATA drives and any peripherals.

Notes

  
*Notes* Some motherboards may only require the use of a 4pin connector. In this scenario the PSU will allow you to split the 8pin connector or will usually have a separate 4pin connector.

**Self Assessment**

Fill in the blanks:

- 7. The series of cables that can be found loose inside the chassis are used for connecting the ..... components.
- 8. Front Panel Components includes a smaller set of cables, that is, the ..... lights as well as the Power and Reset switches.

**4.3 SATA Slots**

SATA or Serial ATA (Advanced Technology Attachment) is the next generation drive interface, following the traditional Parallel ATA (PATA). Anyone who has peered into a computer is familiar with the flat, 40-wire parallel cables that connect the hard drive, CDROM and other devices to their controllers.

SATA Cables (Serial Advanced Technology Attachment) are used for connecting a hard drive or CD drive to the motherboard. This cable is quickly replacing the older and more common IDE Ribbon Cable (PATA). Not only is the Serial ATA cable easier to use than the IDE Ribbon cable because of its small width but it transfers data faster than the older IDE Ribbon cables.

The transfer data rate of Serial ATA cables started at 1.5Gbits but the more recent cables transfer 3.0Gbits and probably up to 6.0Gbits in the recent future.



*Did u know?* It is common to have both SATA and IDE connectors on the motherboard but gradually IDE will disappear from the motherboard all together.

Figure 4.10:SATA Cable

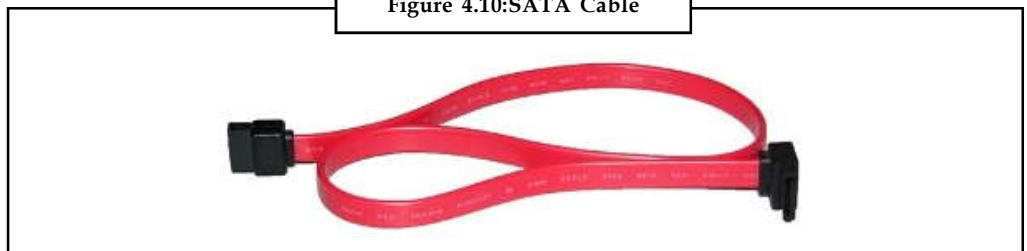

Source: <http://www.computer-hardware-explained.com/sata-cable.html>

**4.3.1 SATA Power Cable**

Along with the introduction of the Serial ATA cable came the SATA power cable. The SATA Power Cable is a 15-pin cable that connects from the power supply to the hard drive or CD/DVD drive. The newer power supplies come with SATA power cables but if not it is possible to buy an adapter to turn Molex power cables (the older more common power cables) into a SATA power cable.

**Self Assessment**

Notes

Fill in the blanks:

9. .... Cables are used for connecting a hard drive or CD drive to the motherboard.
10. The transfer data rate of Serial ATA cables started at ..... Gbits.
11. The SATA ..... Cable is a 15-pin cable that connects from the power supply to the hard drive or CD/DVD drive.

**4.4 IDE Slots**

IDE stands for **I**ntegrated **D**rive **E**lectronics. IDE is a previous connection standard for connecting a drive to a PC. The new standard is SATA or Serial ATA. IDE is now referred to as PATA or Parallel ATA to distinguish it from SATA.

IDE Cables connect from the motherboard of a computer to the hard drive, cd drive and/or floppy drive.

IDE is a standard interface that connects the computer motherboard to a storage device. The most common of these types of cables are the 34-pin floppy drive cable that connects from the motherboard to the floppy drive and the 40-pin ribbon cable that connects from the motherboard to the hard drive and/or the cd drive. The picture below shows both of these cables.

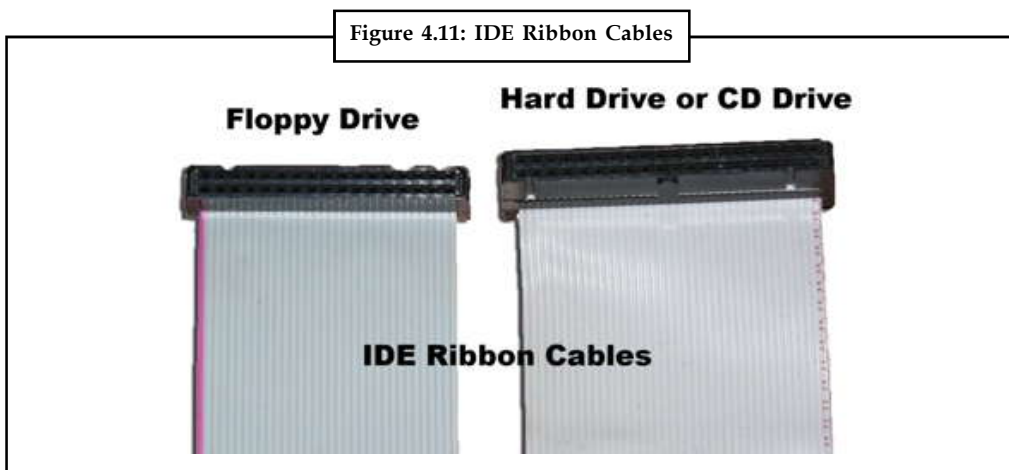

Source: <http://www.computer-hardware-explained.com/ide-cables.html>

The IDE cable is a type of AT Attachment which has had speeds from 33, 66, 100 and 133 MB/s. A faster cable can go in a slower hard drive but a slower cable will decrease the speed of a fast hard drive.

One IDE ribbon cable can connect a hard drive and a cd drive to the motherboard, it can also connect two hard drives to the motherboard.



*Caution* To do this successfully the jumpers must be configured correctly.



*Task* Make distinction between SATA and IDE.



Notes

**Self Assessment**

Fill in the blanks:

- 12. .... is a standard interface that connects the computer motherboard to a storage device.
- 13. IDE is now referred to as .....
- 14. IDE Cables connect from the ..... of a computer to the hard drive, cd drive and/or floppy drive.
- 15. One IDE ..... cable can connect a hard drive and a cd drive to the motherboard.

**4.5 Summary**

- A port is a connector at the back of a computer where you plug in an external device such as a printer, keyboard, scanner, mouse, modem and many more.
- Serial ports are a type of computer interface that complies with the RS-232 standard. Parallel port is used for data transfer between a computer and a peripheral device through a 25 or 36 pin connector.
- Musical Instrument Digital Interface (MIDI) is a standard for digitally representing and transmitting sounds that was first developed in the 1980s.
- A USB port is a standard cable connection interface on personal computers and consumer electronics.
- **Ethernet port** is a port connection that allows a computer to connect to a network using a wired connection.
- A port number is a way to identify a specific process to which an Internet or other network message is to be forwarded when it arrives at a server.
- Once everything is in place, you will want to wire up the entire computer, the best way to do this is to start from the most out of reach cables to the most easily accessed cables.
- SATA Cables (Serial Advanced Technology Attachment) are used for connecting a hard drive or CD drive to the motherboard.
- IDE Cables connect from the motherboard of a computer to the hard drive, cd drive and/or floppy drive.

**4.6 Keywords**

**Ethernet port:** Ethernet port is a port connection that allows a computer to connect to a network using a wired connection.

**IDE Cables:** IDE Cables connect from the motherboard of a computer to the hard drive, cd drive and/or floppy drive.

**MIDI:** Musical Instrument Digital Interface (MIDI) is a standard for digitally representing and transmitting sounds that was first developed in the 1980s.

**Port number:** A port number is a way to identify a specific process to which an Internet or other network message is to be forwarded when it arrives at a server.

**Port:** A port is a connector at the back of a computer where you plug in an external device such as a printer, keyboard, scanner, mouse, modem and many more.

**SATA Cables:** SATA Cables (Serial Advanced Technology Attachment) are used for connecting a hard drive or CD drive to the motherboard.

**Serial port:** Serial ports are a type of computer interface that complies with the RS-232 standard.

**USB port:** A USB port is a standard cable connection interface on personal computers and consumer electronics.

## 4.7 Review Questions

1. Explain the concept of ports.
2. Describe the different types of ports.
3. Make distinction between serial ports and parallel ports.
4. Discuss the functions of USB ports.
5. What is port number?
6. Explain the different ranges of port numbers.
7. Describe the process of wiring up the entire computer.
8. Illustrate the wiring of Front Panel Components.
9. What are SATA cables? Discuss.
10. Explain the use of IDE cables.

## **Answers: Self Assessment**

- |                          |                 |
|--------------------------|-----------------|
| 1. port                  | 2. SCSI         |
| 3. PS/2                  | 4. USB          |
| 5. DVI                   | 6. port number  |
| 7. front panel           | 8. Indicator    |
| 9. SATA                  | 10. 1.5         |
| 11. Power                | 12. IDE         |
| 13. PATA or Parallel ATA | 14. Motherboard |
| 15. ribbon               |                 |

## 4.8 Further Readings



### Books

Barrett, Diane. & King, Todd (2005). *“Computer networking illuminated.”* Jones & Bartlett Learning.

Englander, Irv (2003). *“The architecture of computer hardware and systems software: An Information Technology Approach.”* Wiley.

Sarkar, Nurul (2006). *“Tools for Teaching Computer Networking And Hardware Concepts.”* Information Science Pub.

Shinder, Bebra Littlejohn (2001). *“Computer Networking Essentials.”* Cisco Press.

**Notes**



*Online links*

<http://www.tomshardware.com/forum/59960-3-need-types-computer-ports>

<http://www.computerhope.com/jargon/c/cable.htm>

<http://www.errorteck.com/good-to-know/useful-tips/computer-ports-for-communication-and-networking.html>

<http://www.coolnerds.com/newbies/ports/ports.htm>



## Unit 5: BIOS and CMOS

Notes

### CONTENTS

Objectives

Introduction

5.1 Concept of BIOS and CMOS

5.1.1 POST

5.1.2 Transferring Control to the Operating System with the Bootstrap Loader

5.2 Setting BIOS Configurations

5.2.1 Standard CMOS Configuration

5.2.2 Automatic Configuration of BIOS/CMOS Settings

5.2.3 Advanced CMOS Configuration

5.2.4 Advanced Chipset/Chipset Features Configuration

5.2.5 Power Management Configuration

5.2.6 PnP (Plug-and-Play) Configuration Screen

5.2.7 Peripherals Setup

5.2.8 Security/Passwords

5.2.9 Saving and Recording BIOS/CMOS Settings

5.3 Summary

5.4 Keywords

5.5 Review Questions

5.6 Further Readings

### Objectives

After studying this unit, you will be able to:

- Explain the concept of BIOS and CMOS
- Describe the steps for setting BIOS Configurations
- Discuss the tasks performed by BIOS chips

### Introduction

A complementary metal oxide semiconductor (CMOS) is a type of integrated circuit technology. The term is often used to refer to a battery-powered chip found in many personal computers that holds some basic information, including the date and time and system configuration settings, needed by the basic input/output system (BIOS) to start the computer. BIOS is an electronic set of instructions that a Personal Computer (PC) uses to successfully start up. It is designed to be protected from disk failure. While it can be updated, this should be done carefully to avoid damaging the computer or leaving it unable to start up. In this unit, we will discuss the concept of setting BIOS configurations.

## 5.1 Concept of BIOS and CMOS

Next to the CPU, the BIOS is the most important chip found on the motherboard. A firmware device, the BIOS provides vital services at bootup, hardware standards for your system and, through its configuration utility, many ways to customize your system.

The BIOS (Basic Input Output System) chip performs a variety of important tasks during system operation. On systems that use 32-bit versions of Microsoft Windows (Windows 95 or newer), the BIOS has relatively little to do with system operation after the boot process has been completed. However, during the boot process, the BIOS is an extremely critical component.

Tasks that the BIOS chip performs include:

- Configuration and control of standard devices
- The power-on self test (POST)
- The location of an operating system, to which it turns over control of the system by using the Bootstrap loader

The CMOS (Complementary Metal-Oxide Semiconductor) chip stores the settings that you make with the BIOS configuration program. The BIOS offers you many different options for most system components controlled by the BIOS, but until the settings are stored in the CMOS, the system is unable to run.

The BIOS is a complex piece of firmware (“software on a chip”) that provides support for the following devices and features of your system:

- Selection and configuration of storage devices, such as hard drives, floppy drives, and CD-ROM drives
- Configuration of main and cache memory
- Configuration of built-in ports, such as IDE hard disk, floppy disk, serial, parallel, PS/2 mouse, and USB
- Selection and configuration of special motherboard features, such as memory error correction, antivirus protection, and fast memory access
- Support for different CPU types, speeds, and special features
- Support for advanced operating systems, including networks, Windows 9x, and Windows 2000 (Plug and Play)
- Power management

Figure 5.1: A Typical Socketed BIOS and Battery

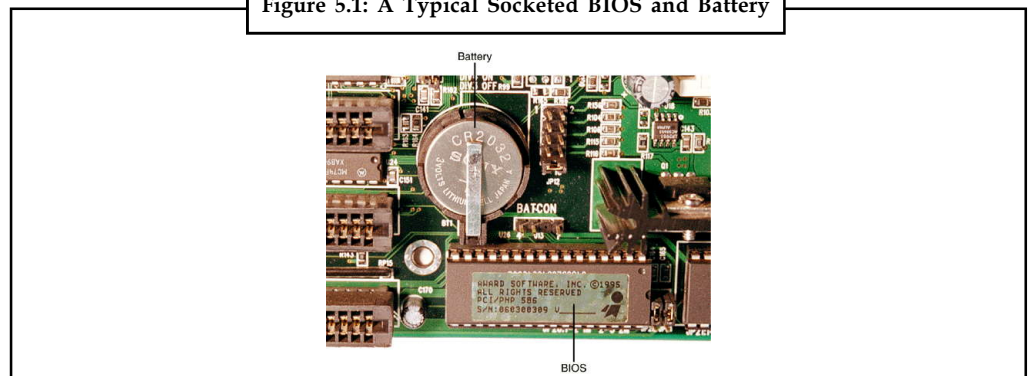

Source: <http://www.informit.com/articles/article.aspx?p=130913&seqNum=7>

## Notes

To enable the BIOS to perform these tasks, two other components on the mother-board work with the BIOS: the CMOS chip, also known as the RTC/NVRAM (Real-Time-Clock/Non-Volatile RAM), and the battery. The CMOS stores the settings that you make with the BIOS configuration program and contains the system's Real-Time-Clock circuit. Power from a battery attached to the motherboard is used by the CMOS to keep its settings. Figure 5.1 shows a typical socketed BIOS and battery.

The CR2032 battery has become the most common removable battery on Pentium-class systems.

Most recent systems use various models of lithium batteries, which can last from two to five years. The most common batteries you will see in Pentium-class and newer systems are the DS12887A-type clock/battery chip and the CR-2032 lithium battery.



*Notes* The AA-size Eternacell was used in many early 286- and 386-based systems made by Zenith Data Systems and others. The Dallas Semiconductor DS12887A clock/battery chip, CR-2032 lithium battery, and the AA-size 3.6 volt Eternacell have all been used in computers for maintaining CMOS settings.

When the battery starts to fail, the clock will start to lose time. Complete battery failure causes the loss of all CMOS configuration information. When this takes place, the system cannot be used until you install a new battery and re-enter all CMOS configuration information by using the CMOS configuration program.

Because the battery maintaining settings can fail at any time, and viruses and power surges can also affect the CMOS configuration, you should record important information before it is lost.

### 5.1.1 POST

The POST (power-on self test) portion of the BIOS allows the BIOS to find and report errors in the computer's hardware. For the POST to work correctly, the system must be configured correctly.

The POST checks the following parts of the computer:

- The CPU and the POST ROM portion of the BIOS
- The system timer
- Video display card
- Memory
- The keyboard
- The disk drives

The system will stop the boot process if it encounters a serious or fatal error. During the POST process, the BIOS uses any one of several methods to report problems:

- Beep codes
- Onscreen error messages
- POST error codes

#### Beep Codes

Beep codes are used by most BIOS versions to indicate either a fatal error or a very serious error. A fatal error is an error that is so serious that the computer cannot continue the boot process.

Notes

A fatal error would include a problem with the CPU, the POST ROM, the system timer, or memory. The serious error that beep codes report is a problem with your video display card or circuit. Although systems can boot without video, seldom would you want to because you can't see what the system is doing.

Beep codes vary by the BIOS maker. Some companies, such as IBM, Acer, and Compaq, create their own BIOS chips and firmware. However, most other major brands of computers and virtually all "clones" use a BIOS made by one of the "Big Three" BIOS vendors: American Megatrends (AMI), Phoenix Technologies, and Award Software (now owned by Phoenix Technologies).

As you might expect, the beep codes and philosophies used by these three companies vary a great deal.



*Example:* AMI uses beep codes for over 10 "fatal" errors. It also uses eight beeps to indicate a defective or missing video card.

Because beep codes do not report all possible problems during the startup process, you should not rely exclusively on beep codes to solve system problems.

Onscreen Error Messages

Most BIOS versions do an excellent job of giving you onscreen error messages indicating what the problem is with the system. These messages can indicate problems with memory, keyboards, hard disk drives, and other components.



*Caution* The system almost always stops after the first error, so a serious problem early in the boot process will stop the system before the video card has been initialized to display error messages.

POST Codes and POST Cards

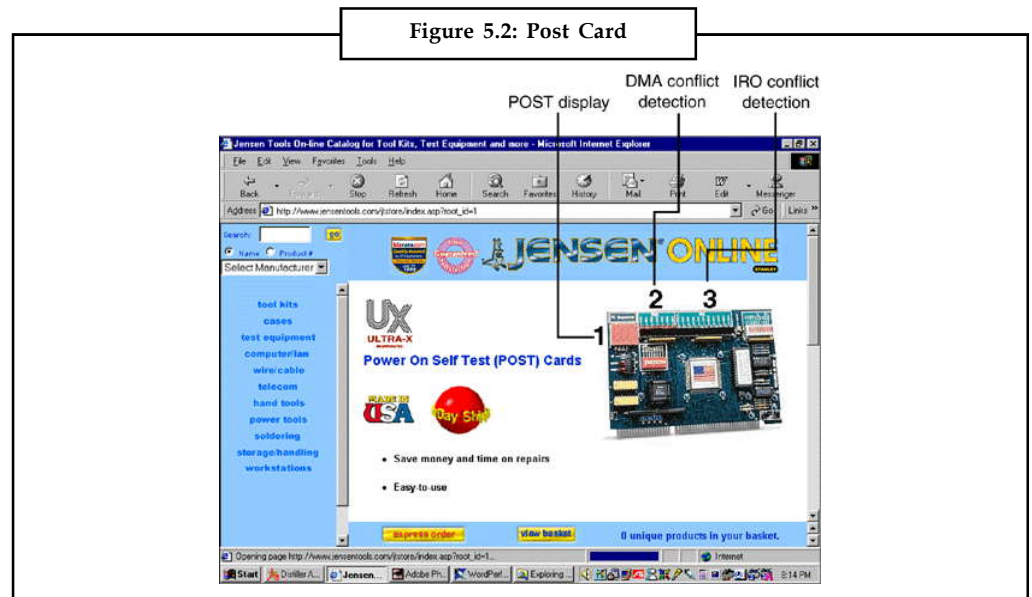

Source: <http://www.informit.com/articles/article.aspx?p=130913&seqNum=7>

One method, used by virtually all devices, is to send data through one of 65,535 I/O port addresses. The POST also uses an I/O port address (usually 80h), sending a series of codes indicating the progress of testing and booting. The hexadecimal codes output by the BIOS change rapidly during a normal startup process as different milestones in the boot process are reached. These codes provide vital clues about what has gone wrong when your system won't boot and you don't have a beep code or onscreen messages to help you.

To monitor these codes, you need a POST card such as the one shown in Figure 5.2, available from a variety of vendors, including JDR Microdevices Vor Jensen Tools. These cards are available in versions that plug into either ISA or PCI expansion slots. The simplest ones have a two-digit LED area that displays the hex codes, whereas more complicated (and expensive) models also have additional built-in tests.

The same hex code has different meanings to different BIOSes.

The Ultra-X PC Inspector card features POST display (1), DMA conflict detection (2), and IRQ conflict detection (3) among its many features.

The best way to learn to use a POST card is to plug it into a healthy system and watch the codes change during a normal system startup. Typically, the codes change very quickly until the final code (often "FF") is reached and the system starts.



*Caution* On a defective system, the codes will pause or stop when a defective item on the system is tested.

The cards remove easily and need not be left in systems routinely.

### 5.1.2 Transferring Control to the Operating System with the Bootstrap Loader

During the POST, drives and other standard devices have been detected. Frequently, information about the CPU, hard disk, floppy disk drive, memory size and type, and ports are displayed onscreen at the end of the POST (see Figure 5.3).

Figure 5.3: A typical Pentium-based system configuration screen displayed on system startup

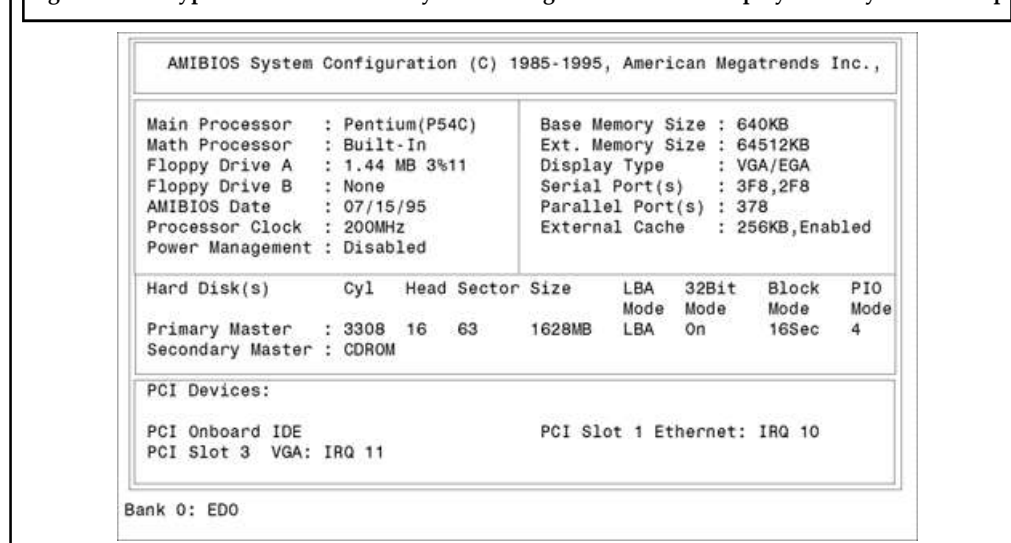

Source: <http://www.informit.com/articles/article.aspx?p=130913&seqNum=7>

**Notes**

Use this information for a quick view of the system’s features, including CPU type and speed, RAM size and type, drive configuration, and more.

Next, the BIOS searches for an operating system on the drives listed in the BIOS configuration as bootable drives. The first drive containing an operating system will be used to start the computer, and at that point the BIOS transfers control of most of the computer to the operating system.



*Did u know?* The portion of the BIOS responsible for starting the system is called the bootstrap loader (from the old expression “pulling yourself up by your bootstraps”).

**Warm and Cold Booting**

A cold boot or hard boot refers to starting the computer with the power or reset switch, which runs the entire POST and bootstrap process. A warm boot or soft boot skips the POST and refers to restarting the computer with the MS-DOS Ctrl+Alt+Del key sequence or the Windows 9x/2000 Start, Shutdown, Restart menu. Figure 5.4 shows a typical screen displayed during a cold boot.

Figure 5.4: The Screen during a Cold Boot

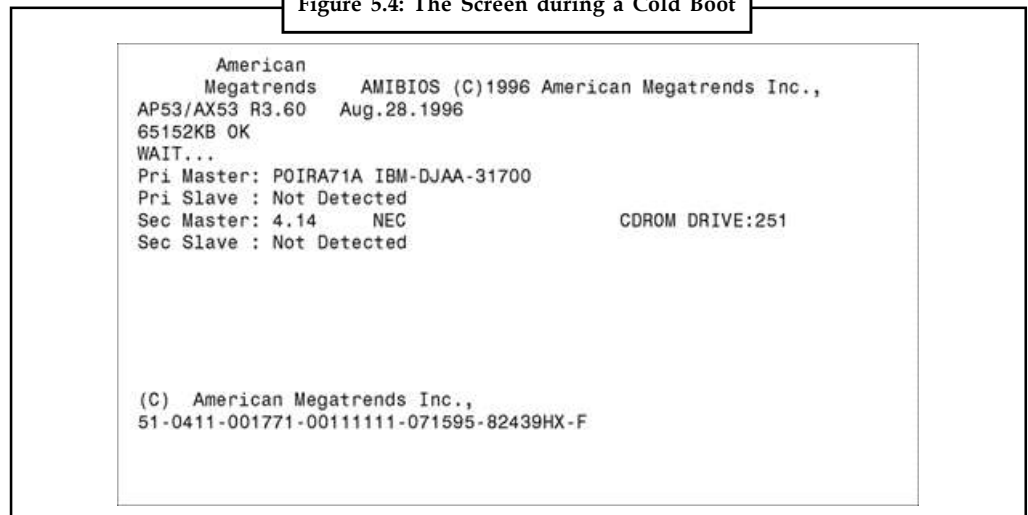

Source: <http://www.informit.com/articles/article.aspx?p=130913&seqNum=7>

Note the memory test at the upper-left side.

On an MS-DOS-based system whose hard disk and floppy disk drives are connected to the motherboard, the BIOS is used to operate the drives. However, for systems using Windows 95 and newer, device drivers are loaded by the operating system to replace the BIOS. Still, without the BIOS, the system would not know what hardware was onboard or whether it was working.



*Task* Compare and contrast cold boot and warm boot.

**Self Assessment**

Fill in the blanks:

1. The ..... chip performs a variety of important tasks during system operation.

2. The ..... chip stores the settings that you make with the BIOS configuration program.
3. Complete battery failure causes the loss of all CMOS ..... information.
4. The ..... portion of the BIOS allows the BIOS to find and report errors in the computer's hardware.
5. .... are used by most BIOS versions to indicate either a fatal error or a very serious error.
6. A ..... is an error that is so serious that the computer cannot continue the boot process.
7. The best way to learn to use a ..... is to plug it into a healthy system and watch the codes change during a normal system startup.
8. A ..... refers to starting the computer with the power or reset switch, which runs the entire POST and bootstrap process.

## 5.2 Setting BIOS Configurations

For the BIOS to be able to start the computer, you've seen that it must find an operating system on a hard disk or floppy disk drive. Floppy disk drives and hard disk drives are two of the most important items that must be configured in the BIOS. If the drive types are not correctly identified in the BIOS, the BIOS will not be able to start the system. Whenever you build a system or change major components, you need to run the BIOS setup program to check or change settings.

ROM-based setup programs are normally started by pressing one or more keys in combination within the first few seconds after turning on the computer. Although these keystrokes vary from system to system, the most popular keys on current systems include the escape (Esc) key, the Delete key, the F1 key, and various combinations of Ctrl+Alt+ another specified key. Most computers display the correct key(s) to press during the initial startup screen. Check with your system vendor for the appropriate keystrokes or to see if you need to run a program from MS-DOS or Windows to configure your system. Because the settings you make in the BIOS setup program are stored in the nonvolatile RAM of the CMOS chip, the settings are often called CMOS settings.

Figure 5.5: Menu Screen

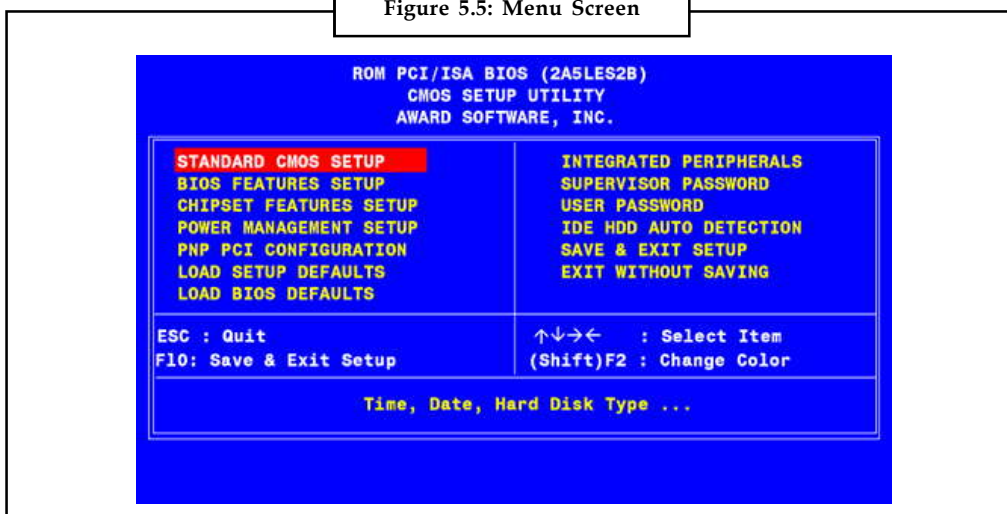

Source: <http://www.informit.com/articles/article.aspx?p=130913&seqNum=7>



Notes

To start the CMOS setup process, press the correct key(s) during the bootstrap process or run the setup program from hard disk or floppy disk after the computer has started. On virtually all systems built since the early 1990s, you'll start with a menu screen, as shown in Figure 5.5. This menu, as well as the contents of the screens listed, will vary according to your BIOS brand, version, and motherboard type.

- Select the menu item from this CMOS Setup menu to examine or change settings.
- Select Standard CMOS Setup to begin.
- Other systems will immediately display the Standard CMOS Setup screen, which is typically used to configure drive, date, and time settings.

### 5.2.1 Standard CMOS Configuration

The standard CMOS configuration screen (see Figure 5.6) includes settings for items such as:

- Date
- Time
- Floppy disk drive types for drives A: (first floppy disk drive) and B: (second floppy disk drive)
- Hard drives connected to the IDE interface

Figure 5.6: A Typical Standard Setup Screen

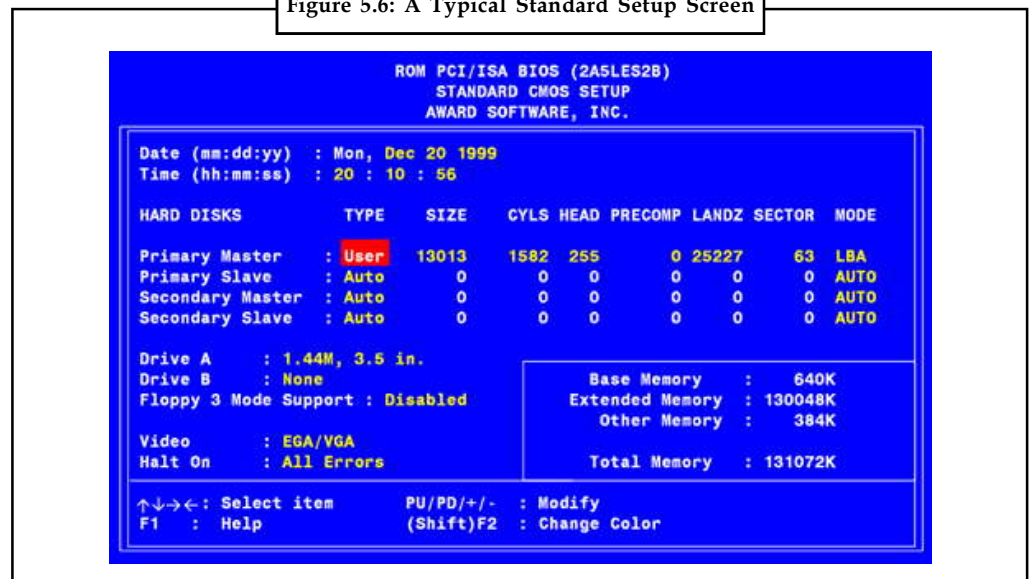

Source: <http://www.informit.com/articles/article.aspx?p=130913&seqNum=7>

On this system, hard drives can be detected during the boot process ("Auto" setting), but they can also be user-defined, as shown here.

To make selections here, you normally press keys to cycle through the different options, including date and time.



Caution The time must be entered in the 24-hour format (1:00PM = 13:00, and so on).



Enable daylight savings unless your state or area (Arizona, Hawaii, and parts of Indiana) doesn't switch to DST in the spring and summer.

Change the default floppy drive types to match your current configuration if necessary.

To select the correct hard drive type, you can use one of three methods:

- Manually enter the correct settings.
- Use an auto-detection feature located here or from the main menu.
- Allow the system to detect the hard drives during every system boot.

Some systems also display the amount of memory onboard on this screen, but only extremely old systems based on 386 or older processors require that you manually enter the amount of RAM in the system. On virtually all systems using a 286 processor or better, the standard CMOS configuration screens are extremely similar, varying mainly in the number and types of drives that can be used.

The standard setup screen is the single most important screen in the entire BIOS/CMOS setup process.



*Did u know?* If the drives are not defined correctly, the system cannot boot.

## 5.2.2 Automatic Configuration of BIOS/CMOS Settings

Many versions of the BIOS allow you to automatically configure all screens except the Standard setup screen with a choice of these options from the main menu:

- BIOS Defaults (also referred to as Original/Fail-Safe on some systems)
- Setup Defaults (also referred to as Optimal on some systems)
- Turbo

Use BIOS defaults to troubleshoot the system because these settings are very conservative in memory timings and other options. Normally, the Setup defaults provide better performance. Turbo, if present, speeds up the memory refresh rate used by the system. As you view the setup screens, you'll note these options are listed. If you use either automatic setup after you make manual changes, all your manual changes will be overridden!

Appropriately, the graphical AMI WinBIOS uses a tortoise, a hare, and an eagle for these three options.

With many recent systems, you can select Optimal or Setup Defaults, save your changes, and exit, and the system will work acceptably. However, you might want more control over your system. In that case, look at the following screens and make the changes necessary.

## 5.2.3 Advanced CMOS Configuration

The advanced CMOS configuration screen, shown in Figure 5.7, allows you to adjust optional details about the computer. In this screen, you can adjust the NumLock setting, type of video, keyboard repeats speed, settings for cache memory, and other special features. Most systems built since the early 1990s include this screen.

Notes

Figure 5.7: advanced CMOS configuration screen



Source: <http://www.informit.com/articles/article.aspx?p=130913&seqNum=7>

A typical Advanced CMOS Configuration screen, also known as the BIOS Features screen—use this screen to enable or disable anti-virus hardware features, adjust boot sequence, and adjust memory options such as cache and parity checking.

Depending on the system, you might be able to boot from CD-ROM, ZIP, or LS-120 drives in addition to the floppy disk drives and hard drives traditionally available as boot devices, as shown in Figure 5.8.

Depending on the BIOS version, you might need to press the ESC key, as in Figure 5.8, to return to the main menu, or use cursor keys to move directly to another menu screen.

Figure 5.8: BIOS Features Setup

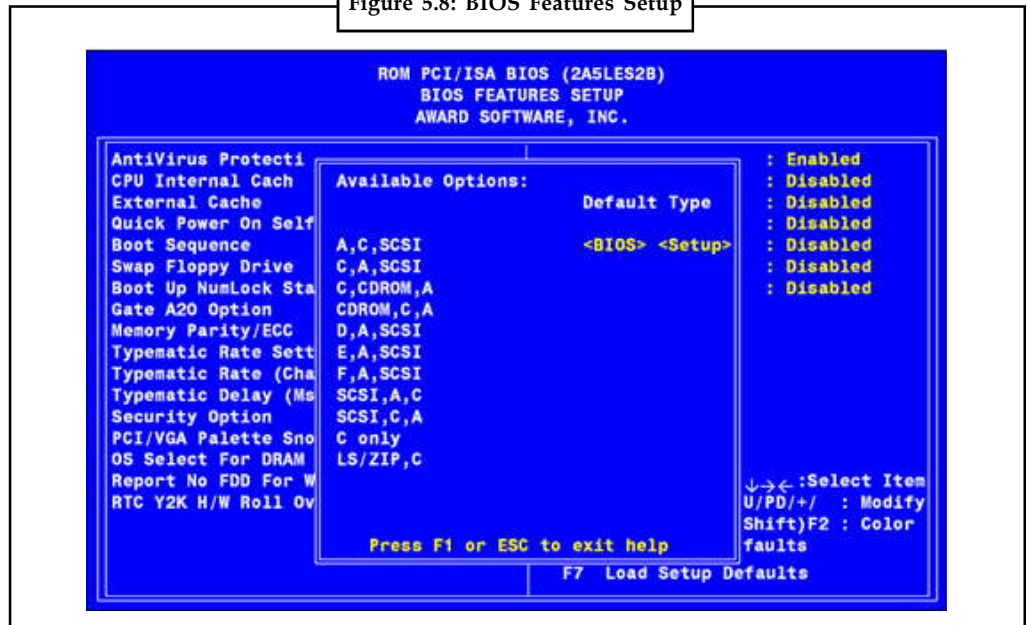

Source: <http://www.informit.com/articles/article.aspx?p=130913&seqNum=7>

This recent Pentium-class system offers a variety of boot options. To view the settings for any CMOS configuration option, either use the help key (F1) as shown here, or press the correct key to step through the options for the setting.

### 5.2.4 Advanced Chipset/Chipset Features Configuration

The Advanced Chipset/Chipset Features Configuration screen, like the one shown in Figure 5.9, offers many advanced options that vary by the system. The following are some typical features of this menu:

- **Memory types, speed and timing**—Adjust the values here to match the memory installed in the system (such as parity, non-parity, SDRAM, EDO, and so on).
- **Cache adjustments**—Some Cyrix CPUs require the user to disable pipelining for proper operation.
- **Configuration of USB ports**—If you upgrade a system to Windows 98 or Windows 2000, you might need to enable the USB ports; systems with older versions of Windows (which didn't support USB) might not have the USB ports enabled. The USB Keyboard Support feature must be enabled if a USB keyboard is installed to allow the keyboard to operate outside of Windows.
- **Configuration of the AGP slot**—Depending on the specific AGP video card installed (if any), you might need to set the size of the memory aperture used to transfer data between the system and the AGP port and select the AGP mode (1x, 2x, and 4x).

Figure 5.9: Advanced Chipset/Chipset Features Configuration Screen

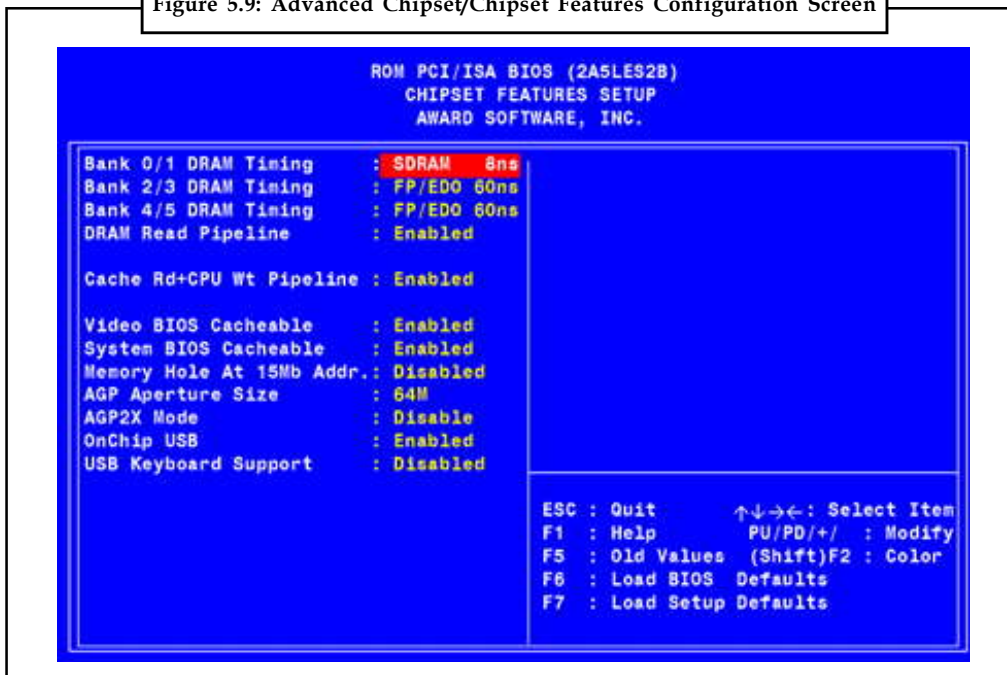

Source: <http://www.informit.com/articles/article.aspx?p=130913&seqNum=7>

This recent system's USB (Universal Serial Bus) and AGP (Advanced Graphics Port) options are located on the Chipset Features configuration screen, along with the usual system and memory-timing options.

Notes

### 5.2.5 Power Management Configuration

Virtually all systems built since the mid-1990s are designed to allow power management; watch for the EPA “Energy Star” logo when you start the computer.

After a user-defined period of inactivity, devices such as the monitor, the hard drive, or even the CPU will go into different low-power modes:

- **Standby mode**—Shuts off the hard drive and blanks monitor screens that use Display Power Management Signaling. Move the mouse or press a key to “wake up” the system.
- **Suspend mode**—Turns off the CPU clock to save even more power. Systems that fully support suspend mode allow you to choose a special shutdown option that “remembers” what programs and files were open, and can bring the system back to that state when the power is restored.

Early power-management systems require that you, the user, keep working with the mouse or keyboard to prevent the system from going into power-saving modes, which can cause modem or network transfers to be interrupted, losing data.

On most newer systems, such as the one featured in Figure 5.10, you can prevent the system from going into power-saving modes, or to wake up when activity takes place, by setting these options by either the device name or by the device’s IRQ.

Power management is always considered a great idea that does not always work well in practice.

Figure 5.10: Power Management Setup

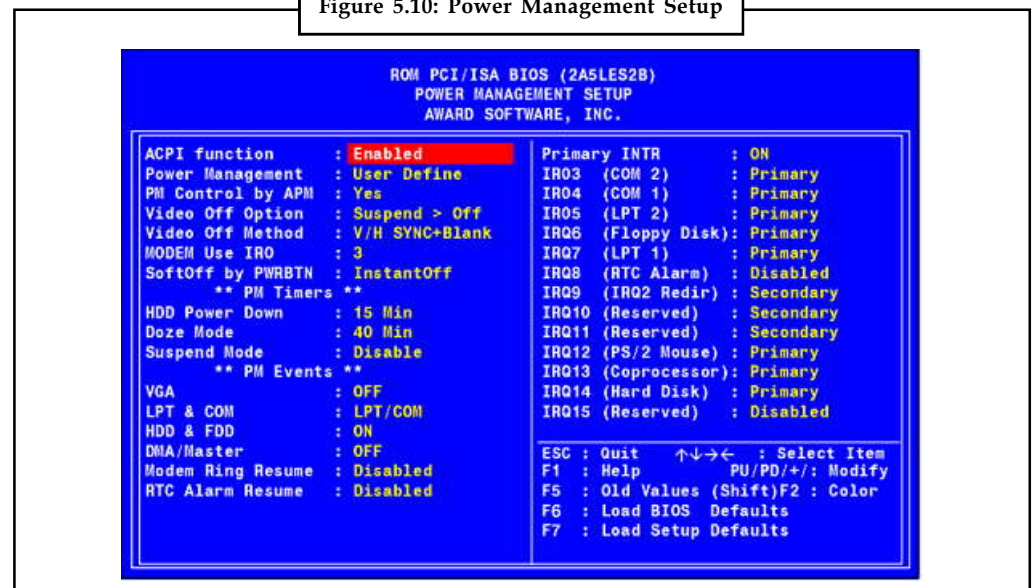

Source: <http://www.informit.com/articles/article.aspx?p=130913&seqNum=7>

This recent system has support for both ACPI power management (used by Windows 98) and APM (used by earlier versions of Windows).

To make power management work, you need to make sure that –

- Devices such as hard drives and monitors can be powered down and powered back up without loss of information.
- Power management is set to monitor network and Internet devices, such as modems and network cards, for activity to prevent the connection from being dropped.
- All devices installed in a system are monitored for activity to prevent data loss.



*Example:* Figure 5.10 does not list IRQ 15 (used by the secondary IDE host adapter in most systems) as a PM (power management) event. Activity on IRQ 15 will not wake up the system, although the computer could be reading data from devices on IRQ 15 or saving data to devices on IRQ 15.

- Users understand how power management works.

Normal signs of power management in use include:

- Monitors with blinking power lights, or power lights a different color than normal, while the screen remains blank
- Keyboards that seem “dead” for a few seconds after you start typing (because the hard drive must spin up)

Users who are unfamiliar with power management might panic and reboot the computers (losing their data!) or demand that you “fix” their systems. Sometimes, the best fix is to disable power management completely or to use Windows to configure power management settings through its Power icon in Control Panel. For systems that have ACPI- compatible BIOS chips that also run Windows 98 or Windows 2000, Windows should be used to manage power.

Adjust the system to the user’s requirements, and continue.



*Task* Make a report on different types of low-power modes.

## 5.2.6 PnP (Plug-and-Play) Configuration Screen

Plug-and-Play (PnP) configuration allows either the operating system or the system BIOS to select hardware settings for PnP-compatible cards when first installed and to change those settings when new cards are installed. PnP BIOS support has been part of virtually all systems shipped with Windows 95 or newer versions of Windows, and virtually all add-on cards and other devices (such as printers, monitors, modems, and so on) also support PnP configuration.

Figure 5.11: Plug-and-Play Configuration screen

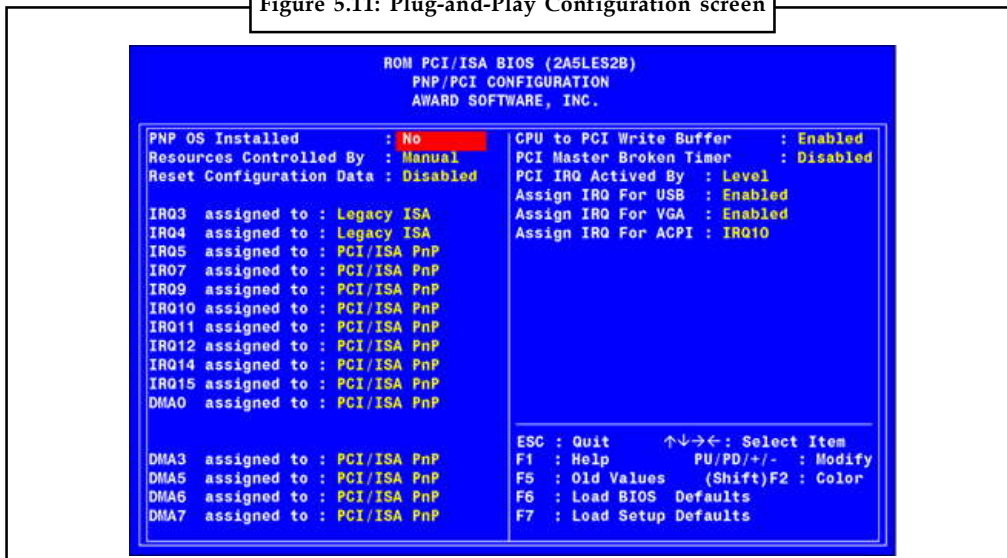

Source: <http://www.informit.com/articles/article.aspx?p=130913&seqNum=7>



Notes

Early versions of the Plug-and-Play Configuration screen (see Figure 5.11) were introduced with the first Pentium-based systems with PCI slots, because PCI cards could configure themselves. PnP can be used with PnP-compatible ISA cards as well as with PCI and AGP cards.

If you are using Windows 95, 98, or 2000, set Plug and Play Operating System to Yes. Unless you have problems with installing cards, that is normally all you need to set. If you are having problems adding cards, you can set IRQs to be available to PnP devices (add-on cards that are set by Windows) or to ISA/Legacy devices (ports built into the motherboard or ISA cards you must set manually).

Some systems, as in this example, also allow you to enable or disable IRQ use for USB, VGA video, and ACPI power management. You can disable IRQ usage for any or all of these devices, but some devices might not work if no IRQ is assigned.

### 5.2.7 Peripherals Setup

You can enable or disable most ports built into recent systems with the Built-in Ports/Peripherals Setup screen, shown in Figure 5.12. (Some systems with PS/2 mouse ports require that you adjust a jumper block on the motherboard.) On some systems, this screen also lets you adjust advanced hard disk options, such as PIO mode and block mode.

By changing PnP options for IRQs and DMA channels to Legacy, you can reserve selected IRQs and DMAs for non-PnP cards.

Figure 5.12: Peripherals Setup Screen

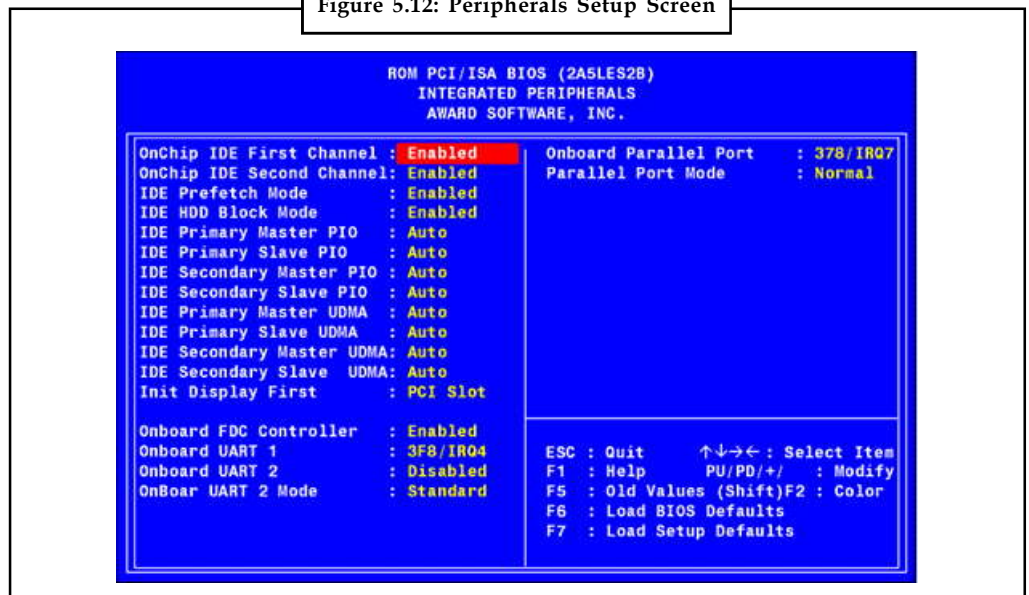

Source: <http://www.informit.com/articles/article.aspx?p=130913&seqNum=7>

This system's COM 2 port (UART 2) is disabled to allow an internal modem to be installed as COM 2.

Generally, you disable a built-in port if you add a card containing a port that will conflict with it.



*Example:* You can disable COM 2 (serial port 2) to allow you to install an internal modem. You can also adjust the IRQ and I/O port addresses used by the built-in parallel and serial ports.



*Notes* On some systems, the LBA mode setting for hard disks and USB configuration options are also found on this screen. After observing or changing the settings, return to the main menu and continue.

Notes

### 5.2.8 Security/Passwords

You can enable two types of passwords on many systems: a power-on password that must be entered to allow any use of the system, and a setup password that must be entered to allow access to the BIOS/CMOS setup. If you don't have all the settings recorded (with screen printouts or by writing them down), this can be dangerous to enable.

Why? If the passwords are lost, users are locked out of the system, and you would need to remove the battery or use the "clear CMOS" jumper on the motherboard to erase the CMOS record of the passwords—and all other settings. This would require reconfiguring the system BIOS from scratch!

Because passwords are useful to prevent tampering with system settings, record the system information first, before you enable this feature.

### 5.2.9 Saving and Recording BIOS/CMOS Settings

Most BIOSes allow you to save your changes, or discard changes you might have made accidentally, when you exit the main menu and restart the system.

A few old BIOSes automatically save any changes, even bad ones. In either case, be sure to review the standard CMOS setup screen and any others you viewed to make sure the settings are acceptable before you save and exit. You should record critical BIOS settings, such as drive type information and any other changes from a system's default settings. Many technicians find it useful to add a sticker with drive type and other information to the rear of a system or to the inside of the system cover.

### Self Assessment

Fill in the blanks:

9. ....-based setup programs are normally started by pressing one or more keys in combination within the first few seconds after turning on the computer.
10. The advanced ..... screen allows you to adjust optional details about the computer.
11. A typical Advanced CMOS Configuration screen is also known as the .....
12. The Advanced ..... Configuration screen offers many advanced options that vary by the system.
13. .... mode shuts off the hard drive and blanks monitor screens that use Display Power Management Signaling.
14. .... mode turns off the CPU clock to save even more power.
15. .... allows either the operating system or the system BIOS to select hardware settings for PnP-compatible cards when first installed and to change those settings when new cards are installed.

### **5.3 Summary**

- The BIOS (Basic Input Output System) chip performs a variety of important tasks during system operation.
- The CMOS (Complementary Metal-Oxide Semiconductor) chip stores the settings that you make with the BIOS configuration program.
- The POST (power-on self test) portion of the BIOS allows the BIOS to find and report errors in the computer's hardware.
- The portion of the BIOS responsible for starting the system is called the bootstrap loader.
- The standard setup screen is the single most important screen in the entire BIOS/CMOS setup process.
- The advanced CMOS configuration screen allows you to adjust optional details about the computer.
- The Advanced Chipset/Chipset Features Configuration screen offers many advanced options that vary by the system.
- Plug-and-Play (PnP) configuration allows either the operating system or the system BIOS to select hardware settings for PnP-compatible cards when first installed and to change those settings when new cards are installed.
- Most BIOSes allow you to save your changes, or discard changes you might have made accidentally, when you exit the main menu and restart the system.

### **5.4 Keywords**

**Beep Codes:** Beep codes are used by most BIOS versions to indicate either a fatal error or a very serious error.

**BIOS:** The BIOS (Basic Input Output System) chip performs a variety of important tasks during system operation.

**Bootstrap loader:** The portion of the BIOS responsible for starting the system is called the bootstrap loader.

**CMOS:** The CMOS (Complementary Metal-Oxide Semiconductor) chip stores the settings that you make with the BIOS configuration program.

**Cold boot:** A cold boot or hard boot refers to starting the computer with the power or reset switch, which runs the entire POST and bootstrap process.

**Plug-and-Play (PnP) Configuration:** Plug-and-Play (PnP) configuration allows either the operating system or the system BIOS to select hardware settings for PnP-compatible cards when first installed and to change those settings when new cards are installed.

**POST:** The POST (power-on self test) portion of the BIOS allows the BIOS to find and report errors in the computer's hardware.

**Warm boot:** A warm boot or soft boot skips the POST and refers to restarting the computer with the MS-DOS Ctrl+Alt+Del key sequence or the Windows 9x/2000 Start, Shutdown, Restart menu.

### **5.5 Review Questions**

1. Explain the concept of BIOS.



2. Describe the relation between BIOS and CMOS.
3. Discuss the tasks performed by BIOS.
4. What is POST (power-on self test)? Discuss the functions of POST.
5. Describe the concept of POST Codes and POST Cards.
6. Explain how to transfer control to the operating system with the Bootstrap Loader.
7. Illustrate the steps for setting BIOS configurations.
8. Discuss some typical features of The Advanced Chipset/Chipset Features Configuration.
9. What is the function of Plug-and-Play (PnP) configuration? Explain.
10. Elucidate the different methods used by BIOS to report problems.

Notes

### Answers: Self Assessment

- |                                       |                              |
|---------------------------------------|------------------------------|
| 1. BIOS                               | 2. CMOS                      |
| 3. configuration                      | 4. POST                      |
| 5. Beep codes                         | 6. fatal error               |
| 7. POST card                          | 8. cold boot                 |
| 9. ROM                                | 10. CMOS configuration       |
| 11. BIOS Features screen              | 12. Chipset/Chipset Features |
| 13. Standby                           | 14. Suspend                  |
| 15. Plug-and-Play (PnP) configuration |                              |

### 5.6 Further Readings



Books

Barrett, Diane. & King, Todd (2005). *“Computer networking illuminated.”* Jones & Bartlett Learning.

Blundell, Barry (2008). *“Computer hardware.”* Cengage Learning EMEA.

Englander, Irv (2003). *“The architecture of computer hardware and systems software: An Information Technology Approach.”* Wiley.

Shinder, Bebra Littlejohn (2001). *“Computer Networking Essentials.”* Cisco Press.



Online links

<http://certification.about.com/od/studyguides1/qt/bioscmos.htm>

<http://www.bcot1.com/bios1.html>

<http://www.computerhope.com/issues/ch000707.htm>

[http://www.utica.edu/faculty\\_staff/qma/biosandcmos.pdf](http://www.utica.edu/faculty_staff/qma/biosandcmos.pdf)

## Unit 6: Installation of OS and Handling Viruses

### CONTENTS

Objectives

Introduction

6.1 Basics of Linux

6.2 Installation of Linux

6.2.1 Before Installation

6.2.2 Hardware

6.2.3 Hardware Compatibility Lists

6.2.4 Server Design

6.2.5 Dual-Booting Issues

6.2.6 Installing Red Hat Linux

6.2.7 Creating a Boot Disk

6.2.8 Starting the Installation

6.2.9 Welcome of Red Hat Linux

6.3 Basics of Windows 7

6.4 Installation of Windows 7

6.4.1 Boot-up your PC from the Windows DVD

6.4.2 Select Language, Time, Currency and Keyboard

6.4.3 Install button

6.4.4 License Terms Agreement

6.4.5 Installation Method Selection

6.4.6 Installation Location Selection

6.4.7 Creating User Name and Computer Name

6.4.8 Password Setting

6.4.9 Product Key Installation

6.4.10 Choosing the form of Installation

6.4.11 Time Settings and Network Settings

6.4.12 Defining your PC location

6.4.13 Finalizing Settings

6.4.14 Opening the desktop

6.5 Application/Utility Software

6.6 Handling Viruses

6.7 Summary

6.8 Keywords

6.9 Review Questions

6.10 Further Readings

## Objectives

Notes

After studying this unit, you will be able to:

- Describe the installation of Linux
- Describe the installation of Windows 7
- Discuss application/Utility software
- Explain the concept of handling viruses

## Introduction

An Operating System is system software which may be viewed as an organised collection of software consisting of procedures for operating a computer and providing an environment for execution of programs. It acts as an interface between users and the hardware of a computer system. An Operating System (OS) is a collection of programs that acts as an interface between a user of a computer and the computer hardware. The purpose of an operating system is to provide an environment in which a user may execute the programs. Operating Systems are viewed as resource managers. The main resource is the computer hardware in the form of processors, storage, input/output devices, communication devices, and data. Some of the operating system functions are: implementing the user interface, sharing hardware among users, allowing users to share data among themselves, preventing users from interfering with one another, scheduling resources among users, facilitating input/output, recovering from errors, accounting for resource usage, facilitating parallel operations, organising data for secure and rapid access, and handling network communications. In this unit we will discuss installing linux and windows. We will also discuss the concept of utility software and handling viruses.

### 6.1 Basics of Linux

Linux is a powerful, non-proprietary, standards-based operating system that is currently the fastest growing computer operating system on the planet. Linux offers speed, performance, stability, and reliability that rivals (or surpasses) that of commercial operating systems costing hundreds or thousands of dollars. Linux contains all the features required of modern desktop PCs, corporate file servers, firewalls, routers, and Internet servers. Its install base is conservatively estimated at over 10,000,000, and is growing at a rate of approximately 3% per week. In fact, Linux market share surged by 212 percent in 1998, and it is the only non-proprietary operating system that is currently demonstrating positive growth. Since it is made available under the GNU Public License as an open source product, Linux may be downloaded free of charge via the Internet, or purchased for a small fee on CD-ROM.

Although Linux was originally designed to operate only on Intel-based PCs, portable and modular coding has allowed it to become increasingly hardware independent. Today, Linux operates on an impressive and growing list of hardware platforms. On the low-end, it powers IBM's Watchpad, G.Mate's Yopy and Sharp's Zaurus Personal Data Assistants. On the high-end, it is used in a growing number of supercomputing environments. Avalon, a supercomputer developed at the Los Alamos National Laboratory, operates under the Linux operating system and was rated among the 500 fastest computers in the world. NASA uses parallel Linux clusters as part of their Beowulf supercomputer. In 1998, Cranfield University (UK) replaced its Cray supercomputer with a Linux-based system of networked Pentium II PCs it calls the Borg. Stanford University uses Linux to power the World's Smallest Web Server.

Linux is also finding its way into embedded devices that are used in a growing number of modern electronic devices. The TiVO digital video recorder is based on Linux, and Linux is even

**Notes**

finding its way into modern high definition television sets. The fast and powerful Google Internet Search Engine is Linux powered. Linux even runs on Apple Power Macintosh and iMac computers! With the downturn in the economy, Linux is proving itself valuable in non-proprietary network routers that offer performance with a cost/benefit ratio unmatched by proprietary routers, such as those by Cisco Systems. The number of Linux devices is growing at a very healthy rate!

**Self Assessment**

State True or False:

1. Linux contains all the features required of modern desktop PCs, corporate file servers, firewalls, routers, and Internet servers.
2. The TiVO digital video recorder is not based on Linux.

**6.2 Installation of Linux**

In this section, we will discuss the process of installing Linux.

**6.2.1 Before Installation**

As Linux has gained market share within the server market, Linux driver development has improved markedly. Storage devices, RAID arrays, Ethernet cards – all have enjoyed increasing Linux driver development in the past few years.

In order to avoid the headache of missing drivers, it's important to do a little research before installing your Linux distribution. While it's unlikely that you'll have a problem with modern distributions, you'll still want to do the research just to avoid any hardware issues.

In order to be able to complete the installation procedure smoothly, you should collect certain information about your system before beginning the installation. Often the installation utility will be able to determine your system configuration automatically but when it fails to do so, you must be prepared to supply the needed information. Otherwise, you'll be forced to terminate the installation procedure, obtain the information, and restart the installation.

The following Table 6.1 specifies the configuration information you need. To obtain this information, you can consult your system documentation and the documentation for any devices installed by you. If your documentation is missing or incomplete, you may need to contact your hardware vendor or manufacturer. Alternatively, you may be able to find the needed information on the manufacturer's web site; use a search engine.



*Example:* Yahoo! or Google can be used to discover the URL of the web site.

**Table 6.1: Configuration Information Needed to Install Linux**

Device	Information needed
Hard Drive(s)	The number, size, and type of each hard drive Which hard drive is first, second, and so on Which adapter type (IDE or SCSI) is used by each drive For each IDE drive, whether or not the BIOS is set for LBA mode

*Contd....*

Notes

<b>RAM memory</b>	The amount of installed RAM
<b>CD-ROM Drive(s)</b>	Which adapter type (IDE, SCSI, or other) is used by each drive For each drive using a non-IDE, non-SCSI adapter, the make and model of the drive
<b>SCSI Adapter (if any)</b>	The make and model of the card
<b>Network Adapter (if any)</b>	The make and model of the card
<b>Mouse</b>	The type (serial, PS/2, or bus) The protocol (Microsoft, Logitech, MouseMan, etc.) The number of buttons For a serial mouse, the serial port to which it's connected
<b>Video Adapter</b>	The make and model of the card The amount of video RAM

To obtain the needed information, you may need to examine your system's BIOS settings or open your system's case and examine the installed hardware. Consult your system documentation to learn how to do so.

### 6.2.2 Hardware

Linux supports a wide range of PC hardware; but not even Linux supports every known device and system. Your PC must meet certain minimum requirements in order to run Linux.

First, determine what kind of hardware you have. Prepare a checklist to assist you. Be as precise as possible, but don't get carried away.



*Example:* If you have an Ethernet card, you need to know what kind (e.g., SMC-Ultra, 3Com 3C509, etc.), base I/O (e.g., io=0x300), interrupt (IRQ 10), but not the hardware address (00 00 a6 27 bf 3c). Not all information will be needed for your hardware. If you have Windows 95 or Windows NT running, you can copy the values from the system hardware device information screen. Otherwise, consult the hardware manuals or the hardware company's Web site.

Linux hardware requirements are modest, but picky. You do not need to have the most advanced and latest model PC to run Linux, but since the development of device drivers is primarily done by volunteers, you need to have devices in your PC for which device drivers have been developed by the Net community.

### 6.2.3 Hardware Compatibility Lists

#### Red Hat/Fedora

Red Hat's major product line is Red Hat Enterprise Linux (RHEL), which is mostly based on Red Hat's free software distribution, Fedora. Fedora is not actually maintained by Red Hat; it's maintained by the community of Fedora developers. However, Red Hat does a lot of work on Fedora, because that work flows into RHEL.

Red Hat's Hardware Catalog doesn't extend beyond RHEL to the Fedora releases, which is something that you'll need to remember when looking to the Red Hat site for Fedora support.

**Notes**

The list provides information on CPUs, video cards, SCSI controllers, IDE controllers, network cards, modems, and sound cards.

**SuSE**

SuSE offers two lists: the Express Search and Extended Search. The difference between the two is that the Extended Search offers fields beyond Vendor, Device, and Category. In practice, you're likely only to need the Express Search.

**Mandriva Linux**

The Mandriva Linux Hardware Compatibility Database is a very comprehensive list of hardware that has been tested by the Mandriva Linux community.

**General Linux**

The Linux Hardware Compatibility HOWTO is perhaps the most comprehensive of the high-level Linux links. It was begun in 1997 and is updated as often as twice annually. It provides information on all device types and all major manufacturers.

Aside from providing interesting and useful user forums, LinuxQuestions.org also provides an outstanding list of Linux-compatible hardware. This is the most up-to-date of the high-level Linux lists, with updates appearing daily where applicable. While it's not as comprehensive as the HOWTO, the LinuxQuestions list is easily as important because of this timeliness.

Linux Compatible provides both updated lists, and forums in which users can help other users resolve existing hardware issues.

**6.2.4 Server Design**

A server installation removes all existing partitions on all installed hard drives, so only choose server installation if you're sure you have nothing you want saved. This means that if you have Windows installed in ANY drive it will delete it and install Linux. As in the workstation installation it will partition the hard-drive(s) and install a variety of software packages, but it will not include many of the user-oriented packages present in the workstation installation.

In order to perform a server installation you will need at least 1.8 GBytes of free hard-disk space. No dual-booting will be set up since no other operating system will exist in the machine (remember that a server installation deletes ALL other operating systems). Therefore, unless you are using your machine solely as a server, it is suggested you to do a workstation installation and then add the server software you may need. This also allows preserving a prior Windows installation when you install Linux.

Use RedHat boot diskette(s) and insert the CD-ROM 1 in the drive. A basic Linux kernel will load and run the installation script. Select server as the installation class. The script, like in the workstation case, will try to detect most of your hardware, but will ask at least what monitor you have, mouse, and TCP/IP information to setup networking. Be sure to create a boot diskette for your machine during the installation - the script will prompt you to do so.

**6.2.5 Dual-Booting Issues**

If you are building your dual-boot server on a new computer, be sure to install and configure Windows first. By default, Windows doesn't recognize any of the native Linux filesystems. But, there are third-party utilities that allow Windows to read the drives of a Linux installation on

the same machine. If Linux is installed first, the Windows boot loader will take over and load Windows; Linux will be there, but you won't be able to boot into it. A Linux installation will cooperate with Windows and allow you to boot into both.

Linux provides a means to read the FAT32 (typically used by Windows 98 and ME) or NTFS (usually used by Windows NT, 2000, and XP) filesystems. In the case of FAT32, you'll also be able to write to the Windows partitions. If you're using an NTFS-based Windows installation, the files on the Windows partition will be read-only.

If you are installing Linux on a system that already contains a Windows operating system, it may be useful to purchase a nondestructive partition management tool, such as Partition Magic. This will allow you to move the partitions on your Windows system, creating room on the drive for the Linux installation, and preserving the data that already exists on the drive.

With the exception of these important points, the process of installing a dual-boot system is the same as a single OS installation.

### **6.2.6 Installing Red Hat Linux**

There is quite a variety of Linux distributions from which to choose from. Each distribution offers the same base Linux kernel and system tools, but differ on installation method and bundled applications. Each distribution has its own advantages as well as disadvantages, so it is wise to spend a bit of time researching which features are available in a given distribution before deciding on one.

The installation of a Linux system requires a little more up-front research than does a Windows installation. As many Linux device drivers are created through community-based reverse-engineering, rather than by those devices' manufacturers, it's important to check a number of hardware compatibility lists prior to commencing the installation. This will help you ensure that drivers exist for the devices on your server.

Linux support can take many forms, the most popular being Web-based lists and forums. This approach truly represents the spirit of community in the open source world, where user experience is relied upon to provide solutions to Linux issues. All commercial Linux distributors provide some level of paid support, though the support period may vary widely from one distributor to another.

Linux systems can be installed with a full complement of graphical tools, or as a minimal text-based system. The installers follow suit, providing options to complete an installation from a graphical environment, or from a purely text-based environment.

Unlike Windows systems, the desktop environment is not inextricably bound to the operating system kernel code. Instead, the X Windows and desktop management systems are distinct systems that run in their own space. This feature of Linux allows for the creation of a fully operational, text-based system, which boasts a very small installation code base. However, most users will opt for a graphical system based on X Windows and any of a number of desktop managers.

### **6.2.7 Creating a Boot Disk**

In order to install Linux, we must begin by booting the Linux kernel. This is accomplished in exactly the same manner as if you wanted to reload MS-DOS: we need a boot disk. But most distributions come only with a CD-ROM, and even if we had a running Linux system, the command to create boot disks for Linux is different than for MS-DOS. If you bought a new computer with a bootable CD-ROM, some distributions allow you to boot in this manner. But we'll go through the process of creating a boot disk for the rest of us.

## Notes

The first step in getting Red Hat's distribution of Linux onto a system, you need to find a way of starting the installation program. The usual method of doing so is to create an installation disk, although if you are installing from CD-ROM, and your system's BIOS supports it, you should be able to boot directly into the installation program from the CD.

Otherwise, to create an installation diskette, you'll need to copy the "boot.img" (which is simply an image of an ext2-formatted Linux boot diskette with an additional installation program) onto a floppy diskette. The "boot.img" file can be obtained from the /images directory of the Red Hat CD-ROM disk, or downloaded via FTP from ftp://ftp.redhat.com in the /pub/redhat/redhat-6.1/i386/images directory (assuming you are installing Linux on an Intel box).

You can create the boot diskette either from a DOS or Windows system, or from an existing Linux or Unix system. For your destination diskette, you can use either an unformatted or a pre-formatted (for DOS) diskette - it makes no difference.

Under DOS: Assuming your CD-ROM is accessible as drive D:, you can type:

```
d:
cd \images
..\dosutils\rawrite
```

For the source file, enter "boot.img". For the destination file, enter "a:" (assuming the diskette you are created is inserted into the A: drive). The "rawrite" program will then copy the "boot.img" file onto diskette.

Under Linux/Unix: Assuming the "boot.img" file is located in the current directory (you may need to mount the CD-ROM under /mnt/cdrom and find the file in /mnt/cdrom/images), you can type:

```
dd if=boot.img of=/dev/fd0
```

The "dd" utility will copy, as its input file ("if"), the "boot.img" file, onto the output file ("of") /dev/fd0 (assuming your floppy drive is accessible from /dev/fd0).

Unless your Linux or Unix system allows write permissions to the floppy device, you may need to do this command as the superuser. (If you know the root password, type "su" to become the superuser, execute the "dd" command, and then type "exit" to return to normal user status).

With either of the above schemes, you should now have a bootable Red Hat installation diskette that you can use to install your new Red Hat Linux system.

## 6.2.8 Starting the Installation

To begin the installation, put the first installation CD in the CD-ROM drive and reboot the machine. If your machine is configured to boot from the CD-ROM, you'll see the screen shown in Figure 6.1, when the machine starts.

The initial installation offers several options. You can choose to install in graphical mode by hitting Enter, or in text mode by typing linux text at the boot: prompt. Either way, the first thing the installer will do is offer to check the installation media for you. This is a good way to determine if your installation CDs have been tampered with, or have become corrupted. The process will take a little while, but it is recommended that you do run this test.



*Did u know?* Like any operating system, Linux requires a minimal set of hardware drivers during the installation.



Figure 6.1: The Initial Fedora Installation Screen

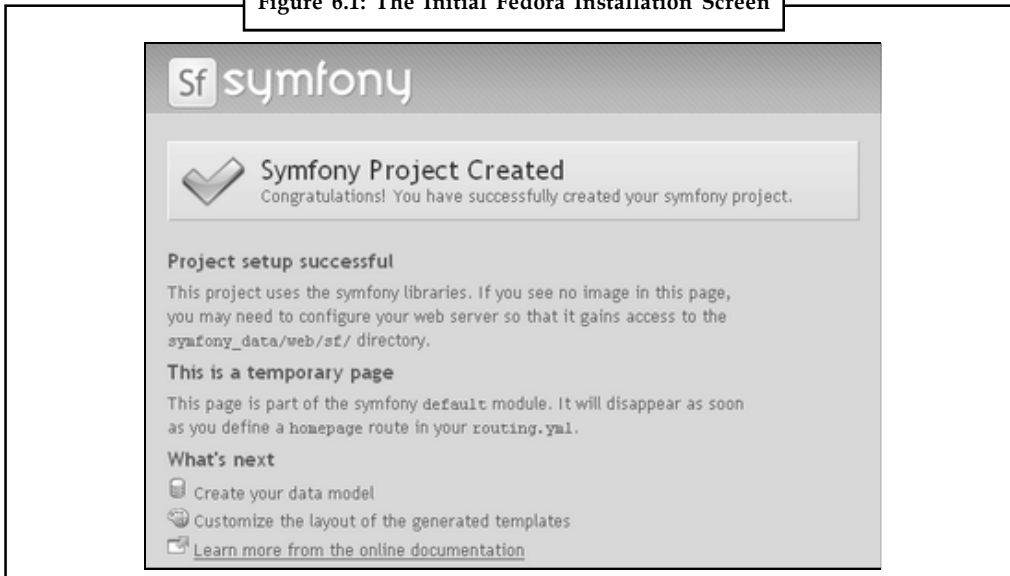

After testing the installation media, you'll see lots of text scrolling down the screen – this is the initial hardware probing process in action. Red Hat helped pioneer the development of graphical Linux installers with Anaconda, Red Hat's installation program. It includes a highly accurate probing and testing mechanism that makes the rest of the installation routine quite painless.

Once all this media testing and hardware probing is done, you'll finally see the Welcome to Fedora Core screen. Click the Next button to get started.

### Selecting your Language

Figure 6.2: Choosing an Installation Language

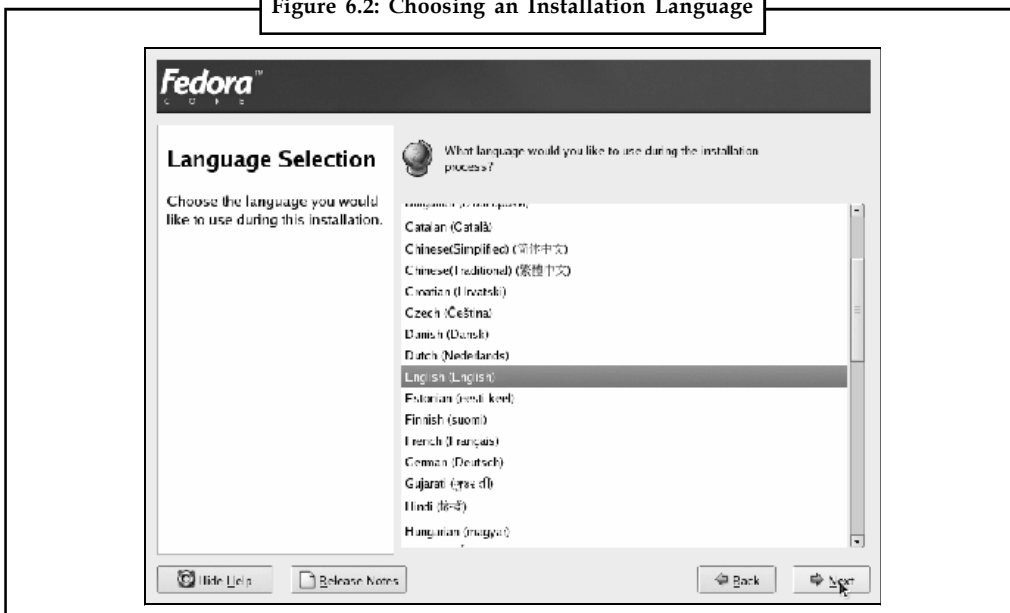

Fedora is truly an international operating system: the installation screens are available in more than 30 languages. Select your native tongue from the Language Selection screen shown in Figure 6.2, and click Next.

Notes

Figure 6.3: Choosing a Keyboard Layout

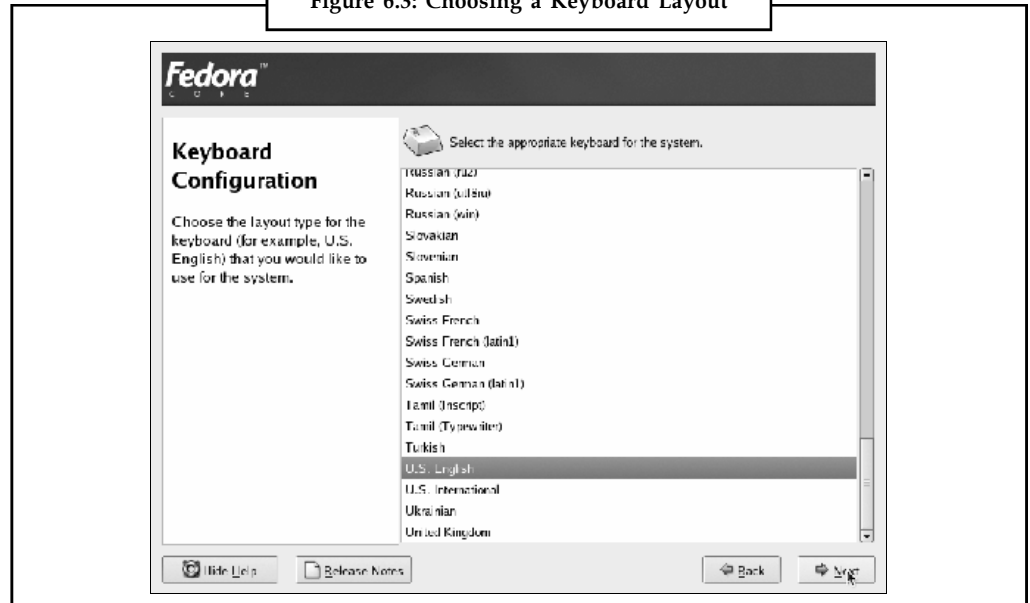

The number of keyboard languages available to Fedora is similar to the number of languages available through the installation screens. Select the language of your keyboard from the screen shown in Figure 6.3.

### Installation Types

The Fedora installer offers three specialized installation types: Personal Desktop for home or office use, Workstation for development or system administration work, and Server for file, print and Web server use. There's also a Custom option if you'd like to take complete control over the way your system is configured. As we're setting up a Web server, select the Server option from the Installation Type screen shown in Figure 6.4, before clicking Next.

Figure 6.4: Choosing an Installation Type

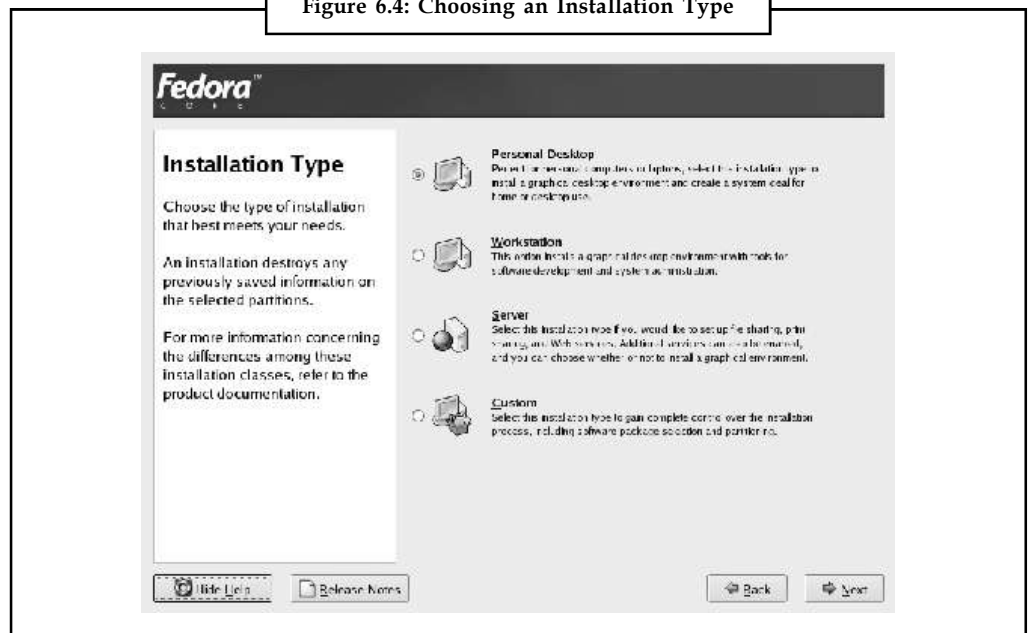

## Disk Partitioning

Notes

The Fedora installer offers two partitioning methods – automatic and manual – as shown in Figure 6.5.

Figure 6.5: Selecting a Partitioning Method

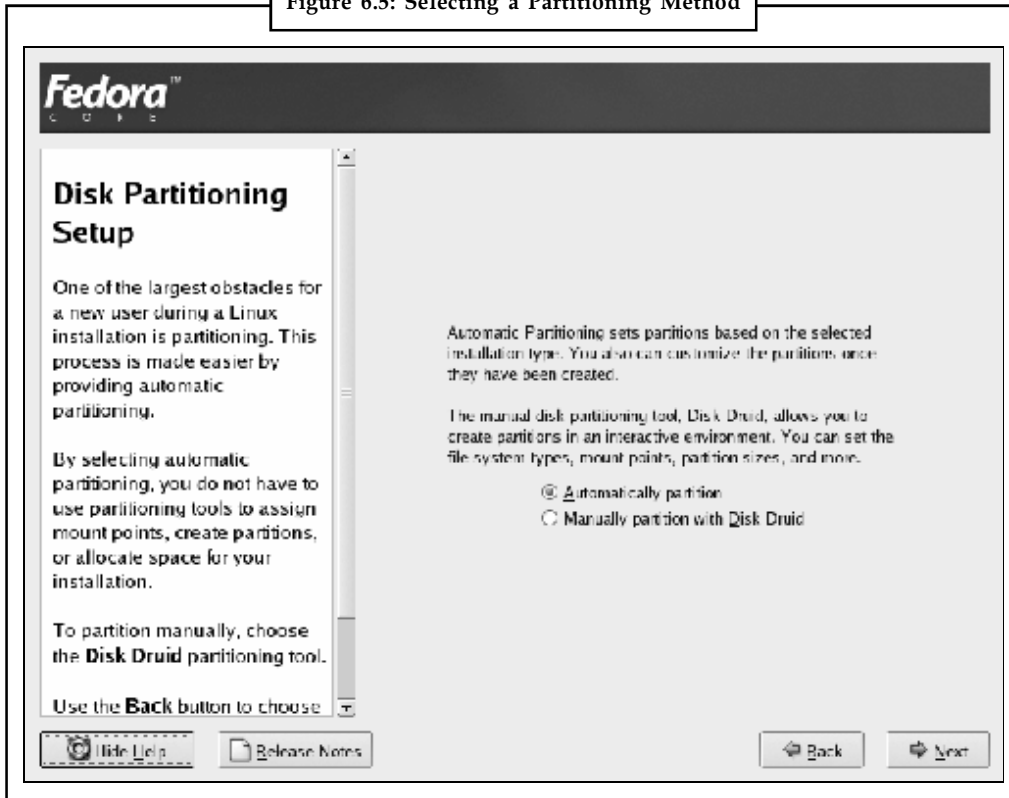

Automatic partitioning creates three partitions:

1. The `/boot` partition is the home of the kernel: the program at the very heart of Linux. Fedora recommends a `/boot` partition of no less than 100MB, though you'll seldom need this much.
2. The swap partition is used as a fallback for memory when all of the system memory is in use.
3. The `/` partition contains everything that isn't on its own partition.

Partitions in Linux appear differently than those in Windows. Linux partitions don't use the drive letter designations, such as C:, which you may already be used to. The primary partition on Linux is labeled `/` (you'll see how this fits into the overall partitioning layout later). Other common partitions on a system include `/boot` (contains the kernel and boot loader), `/home` (contains user-specific files), and `/var` (contains program configuration and variable data). These labels are called mount points. It's possible to organize your system so that it's spread over multiple partitions.



*Example:* It's quite common to put `/var` (where data, including such things as MySQL databases and Websites, live) on a separate partition. However, automatic partitioning makes things simpler, and spreading your data across different partitions doesn't achieve very much.

Notes

 Notes Some administrators strongly recommend it, but the Fedora rescue CD will help you avoid most problems that might have been aided by splitting the data across different partitions in the past. Therefore, the default partitioning setup is usually sufficient.

**Using Disk Druid**

Fedora also offers Disk Druid, a graphical partitioning tool. If you'd prefer a scheme other than the default, you'll need to use Disk Druid during the installation process. Disk Druid presents both graphical and textual representations of the partition table on your machine. To select a partition, click on the graphical drive representation (shown in Figure 6.6), or on the textual representation. In either case, you can add, edit, or delete partitions by clicking on the appropriate tool bar buttons.

Figure 6.6: The Disk Druid Partitioning Tool

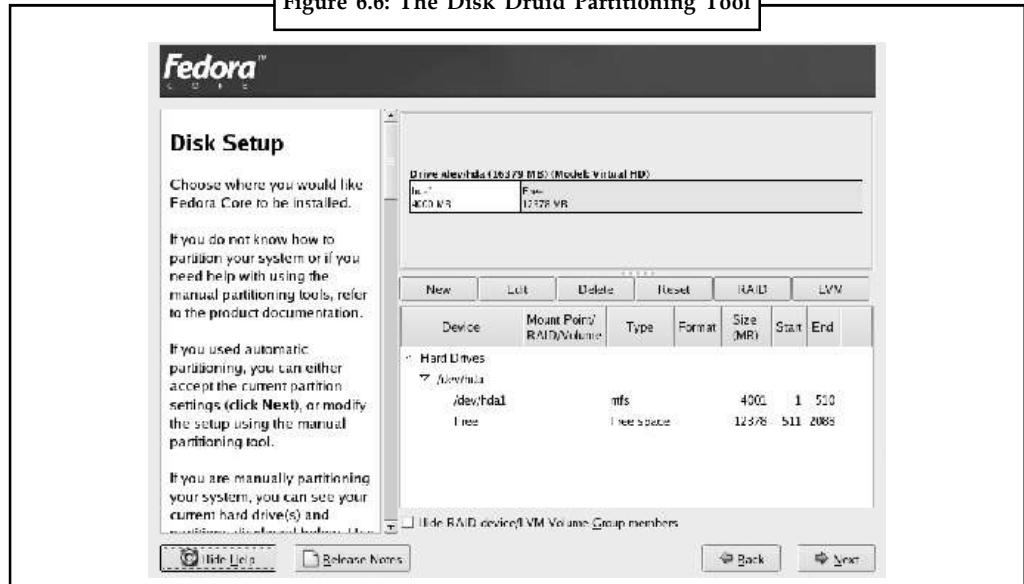

If the system onto which you're installing Linux has a previous installation of Windows (or some other operating system), you might want to manually delete the partition that contained Windows. Also, if you don't see any space marked as "Free" in the diagram at the top of the screen, you'll need to delete something to make room for Fedora. To do this, select the partition to delete, and click the Delete button.

**Deleting Partitions**

Once you delete a partition, there's no way to get back the data that was on it. (Well, there's no easy way. Advanced recovery tools do exist.) Delete with care.

**Correcting an Accidental Deletion**

If you accidentally mark a partition for deletion, or make some other mistake, you can set everything back to its original state by clicking the Reset button. The changes you make to the partitions won't actually take effect until later in the installation procedure.

Click the New button to open the Add Partition dialog shown in Figure 6.7.

Figure 6.7: Adding a Partition

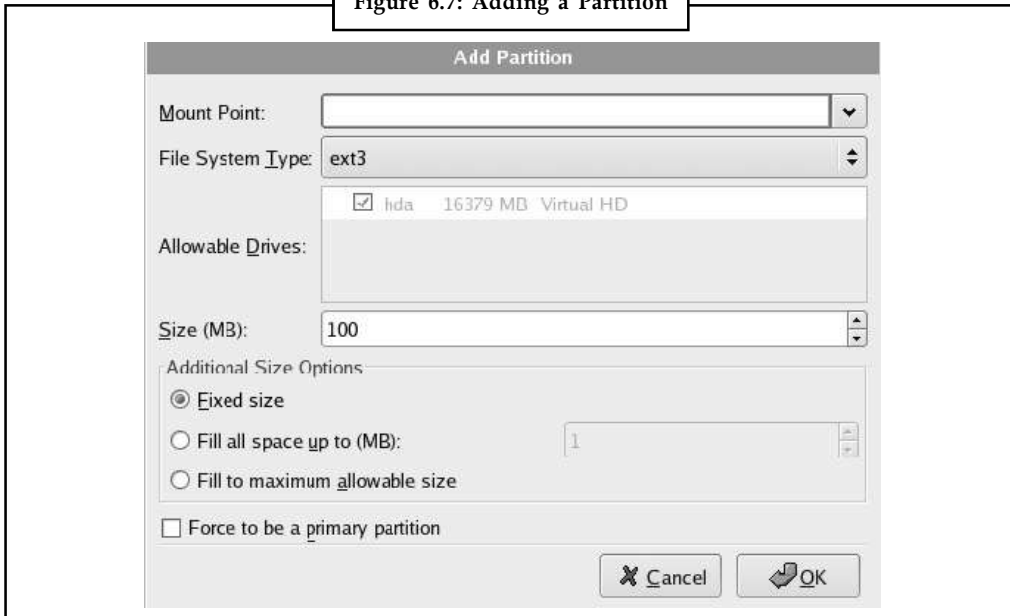

From here, you can designate the mount point, the filesystem type, and the partition's size in megabytes. The window also offers further size options, including the ability to create a partition with all remaining space on the drive.

Selecting the Mount Point drop-down will display all common partition labels (mount points) available for your server, as shown in Figure 6.8, "Selecting a mount point."; alternatively, you can enter the mount point label manually. Bear in mind that these are the most common mount points, and are familiar to all Linux system administrators. Creating a custom mount point might confuse other administrators of your server.

Figure 6.8: Selecting a Mount Point

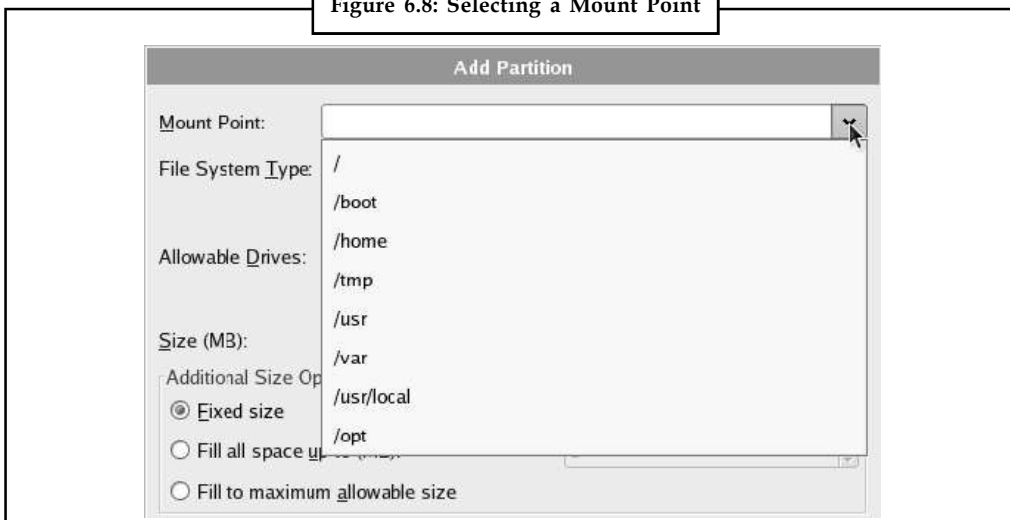

Once you have created a partition, you can edit it by selecting the partition, then clicking the Edit button, which will give you almost the same options as the Add Partition dialog.

If you try to proceed past the Disk Setup screen without creating a swap partition, you'll receive the warning shown in Figure 6.9. A swap partition in Linux serves much the same purpose as

Notes

virtual memory in Windows: when the system’s memory becomes full, part of the data in memory is written to the swap partition, freeing up that memory space. When the data that was written to the swap partition is needed again, it is read back into memory. To create a swap partition, click the Add button and select swap as the File System Type.

Figure 6.9: The Swap Warning

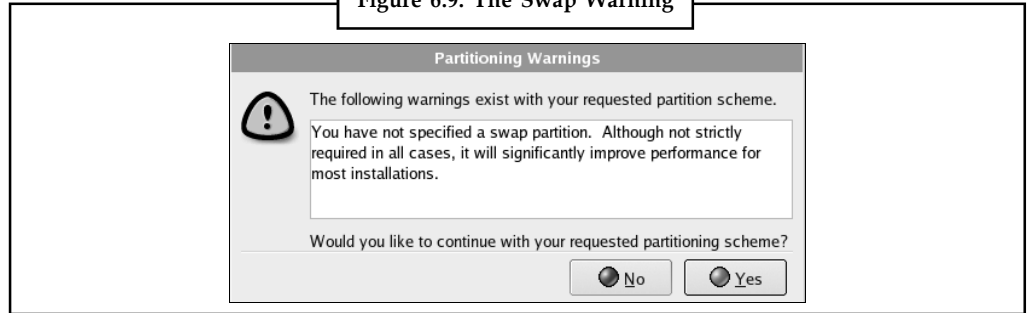

Swap Space

A good rule of thumb to use when creating swap space on your Linux machine is to create one and a half times the size of the machine’s physical memory.



Example: If you have 1GB of physical memory, create a 1.5GB swap partition.

The GRUB Boot Loader

Figure 6.10: Configuring GRUB

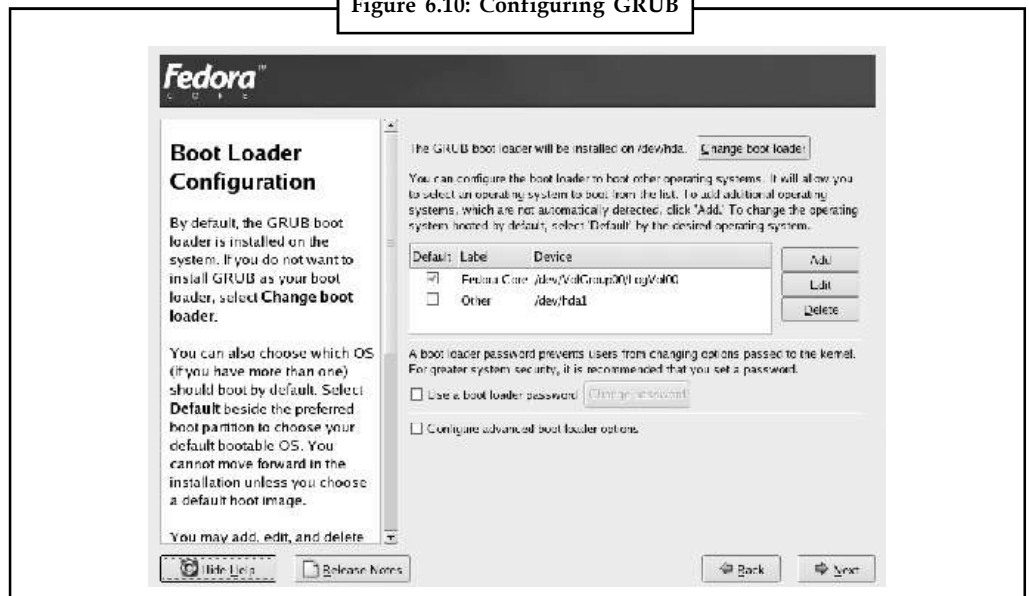

If you have decided to go with a dual-boot install, you’ll need to set up the GRUB boot loader. GRUB is a program that will let you select from a list of installed operating systems, then makes the computer start up the selected OS. As Figure 6.10 shows, it’s pretty easy to set up.



Caution You should set a boot loader password to prevent unauthorized users from gaining access to the kernel’s startup parameters.

## Networking

## Notes

After you've set up all of your partitions, you'll be offered the networking options shown in Figure 6.11, "Configuring Fedora's networking options." Existing Ethernet cards within the machine will be denoted as ethn; if the machine has only one network card, it will be called eth0. The default configuration will be something like that displayed in Figure 6.11. The first network connection (usually eth0) will be made active, and will be automatically configured via DHCP. Dynamic Host Configuration Protocol (DHCP) will be used to auto-detect your network settings to enable you to connect to the Internet, or to a private network.) If the machine is on an internal network, you'll probably be able to just leave this as the default. For a Web server that's connected directly to the Internet, you'll need to manually configure your static IP address and manually-configured gateway, DNS, and hostname. In this case, your ISP will be able to provide you with the IP address, gateway, and other details to use.

Figure 6.11: Configuring Fedora's Networking Options

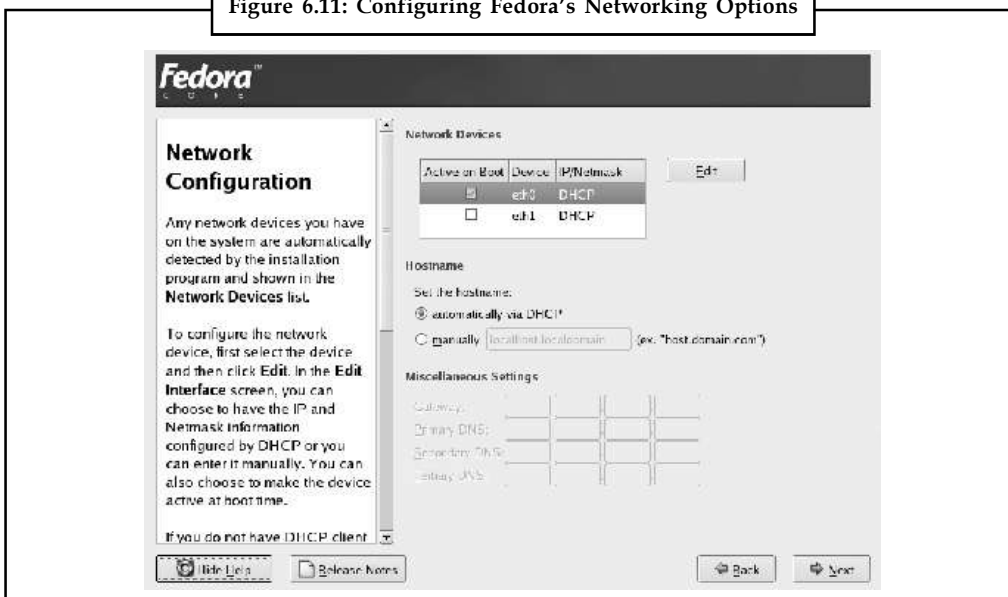

Clicking the Edit button in the Network Configuration screen will display the Edit Interface window shown in Figure 6.12. Here, you can make custom configuration adjustments such as giving the server a static IP address.

Figure 6.12: Manually Configuring the Ethernet Interface

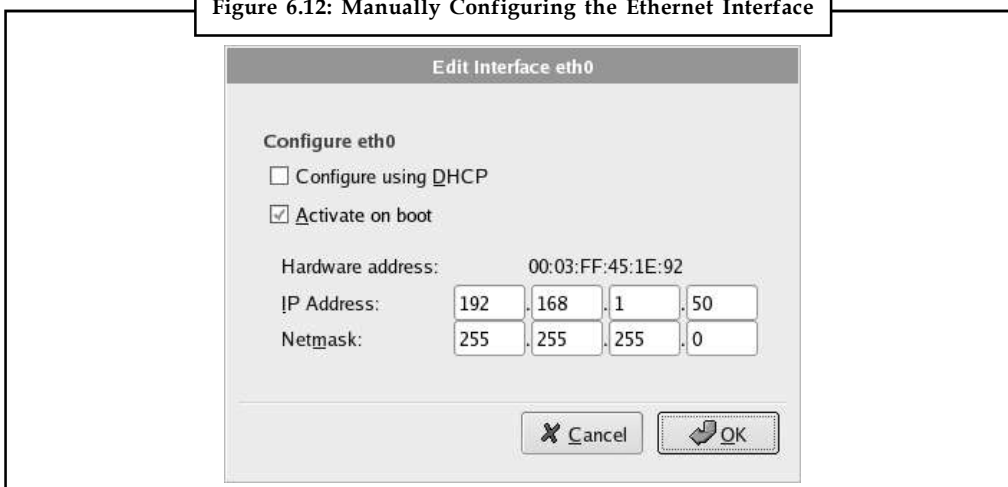

Notes

When the network device settings have been configured from the previous screen, you're free to configure the hostname, gateway and DNS settings. Figure 6.13 shows a network device configured primarily for internal use.

Figure 6.13: A Manually Configured Network Interface

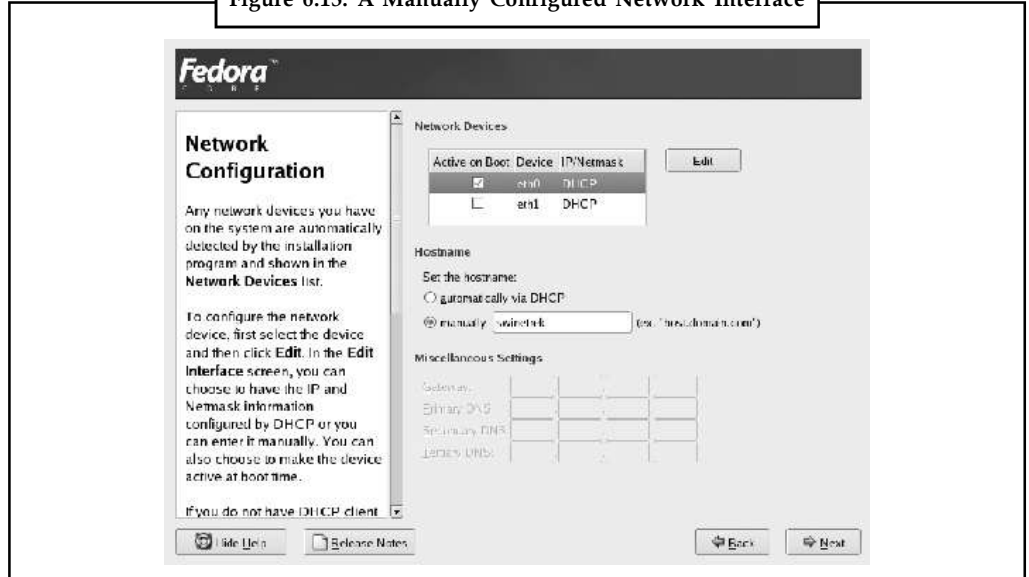

Network Security

The Fedora Core distribution – and many of the other major distributions of Linux –strive to make configuring your network security as easy as possible. By default, Fedora turns on a firewall that blocks all traffic coming in from the network. To customize the firewall, simply select the services you want to run on this machine; alternatively, you can simply disable the firewall, which will leave the machine open and vulnerable to hacker attacks. You can also choose to enable Security Enhanced Linux (SELinux), which can help to minimize any damage caused if hackers gain control of parts of the system.

Figure 6.14: Setting Server Security Options

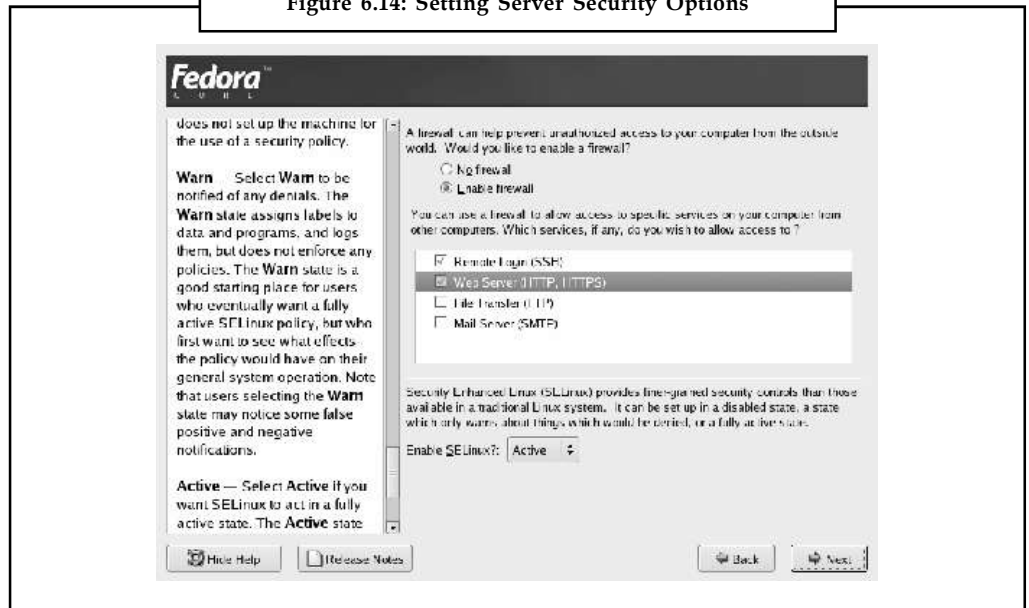



Note that SELinux should not be considered an alternative to a firewall – neither the firewall, nor SELinux, makes your system completely secure, so it's best to enable them both. For our purposes, you should only allow Remote Login and Web Server traffic through the firewall, and set Enable SELinux? to Active, as illustrated in Figure 6.14.

### Telnet and FTP Security

Though they're shown as options in the Fedora security configuration screens, both telnet and FTP are widely recognized as insecure protocols. SSH is a much more secure option than telnet for accessing remote machines, as SFTP is a more secure option than FTP for transferring files. If an FTP capability is required, it's recommended that it be set up on a different server that's isolated as much as possible from the rest of the network.



*Task* Make distinction between Telnet and FTP.

### Setting the Time Zone

Fedora offers two options for setting the time zone for your server. You can roll the mouse over the metropolitan area that's closest to you, or you can select from an exhaustive list of cities. In either case, the chosen city will be highlighted on the map, as shown in Figure 6.15.

Figure 6.15: Setting the Time Zone



### Setting up the Root User

All Linux systems have an administrative account, root. This account has access to everything on the computer; it's similar to the Administrator account in Windows systems. As the power of root in Linux is so broad, it's critical that you make accessing the root account as difficult as possible. Choose a secure password for the root account – one that consists of both upper and lowercase letters, as well as numbers and special characters – and enter it into the fields as shown in Figure 6.16. It is recommended that you record your root password somewhere and keep it safe: if you forget the password, it becomes very difficult to gain access to your machine should things go wrong.

Notes

Figure 6.16: Setting the Root Password



Installing Software Packages

Previously, when you were asked to select an installation type (you selected from personal desktop, workstation, server, or custom), your selection determined which software package groups would be made available for selection in this screen. For your server installation, you'll see the full range of server software offered as part of the Fedora distribution, with a few nice extras thrown in. Select each of the package groups you want to install by clicking the appropriate check boxes, as shown in Figure 6.17.

Figure 6.17: Selecting Package Groups

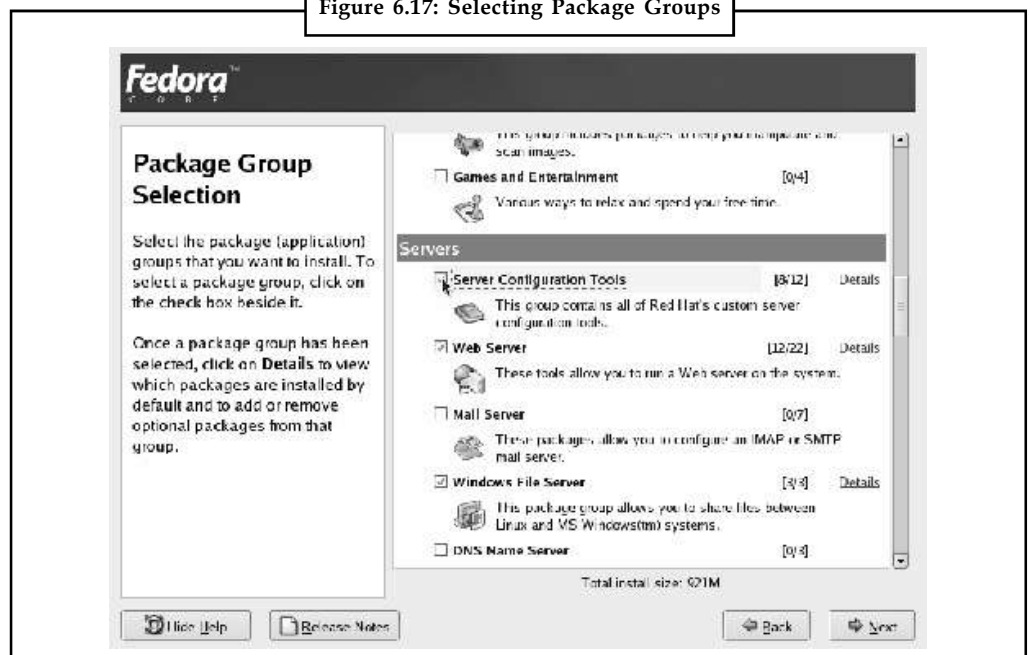

Each package group contains a number of packages; you can see a list of these (similar to the one shown in Figure 6.18) by clicking the Details link that appears when the package group is checked. This list is made up of base packages – packages that are required for this package group – and optional packages, which you can choose to install as your needs dictate.

Figure 6.18: Refining the Package Selection

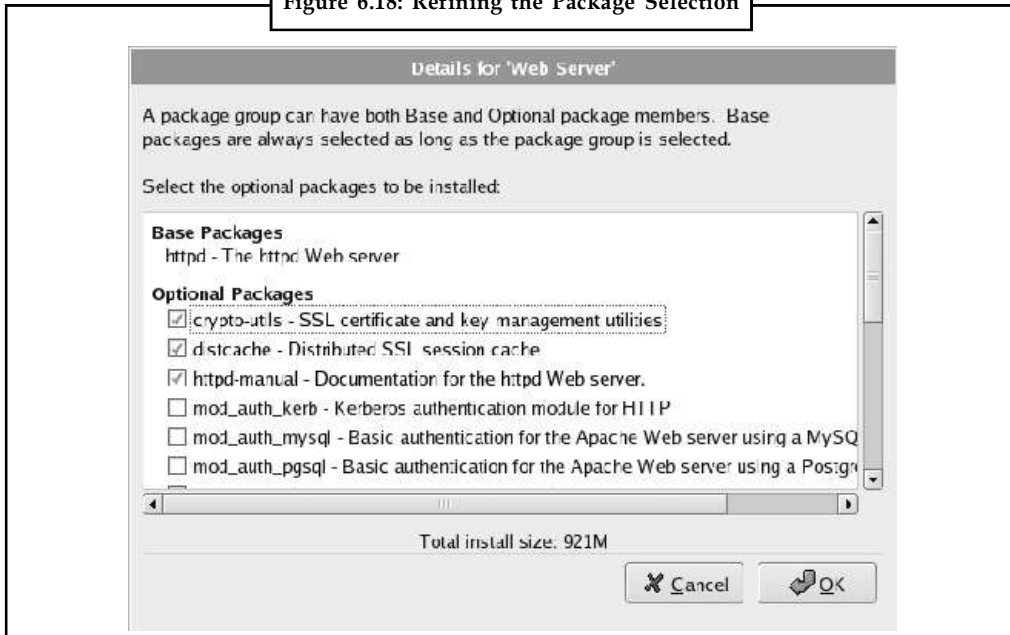

Through a long process of refinement, the Red Hat distributions have come to provide a full range of packages that meet nearly any common computing need. While it's a good goal to keep a server installation to a minimum, you may find that there are some packages you just can't do without. If you're using Linux for the first time, it's perfectly okay to accept the defaults; it's easy to add packages later if you realize that something else is required, and the defaults are carefully chosen by the Fedora team to cover the needs of most people.

## 6.2.9 Welcome of Red Hat Linux

Figure 6.19: The Setup Agent's Welcome Screen



Notes

With the main installation completed, a few housekeeping items are all that remain to be done. Your Fedora server will walk through the process of loading drivers, then present you with the Setup Agent: a set of tools for configuring your system once it has been installed. The use of such tools has become a common approach among Linux distributions, with SuSE providing the YaST2 tool, and Mandriva utilizing SystemDrak. You'll be presented with the Setup Agent's welcome screen, shown in Figure 6.19, followed by the licence agreement. Once you've indicated that you agree to the license, you'll enter the configuration screens.

The Date and Time configuration screen provides two tabs: Date & Time and Network Time Protocol. The first tab allows you to confirm that the system clock is accurate. The second tab provides the ability to configure the Network Time Protocol (NTP) software, which can be used to synchronize your system's clock with an authoritative source. Selecting Enable Network Time Protocol in this screen, as illustrated in Figure 6.20, will enable the NTP daemon - a program that runs in the background, periodically checking your system time against the time returned by an NTP server. Several of these servers are listed in the Server drop-down (a good NTP server is pool.ntp.org. This is actually a name shared by many servers, ensuring that it's always available). If NTP is enabled and a server selected, the daemon will start, checking the selected server before moving on to the next Setup Agent screen.

Figure 6.20: The Network Time Protocol Tab

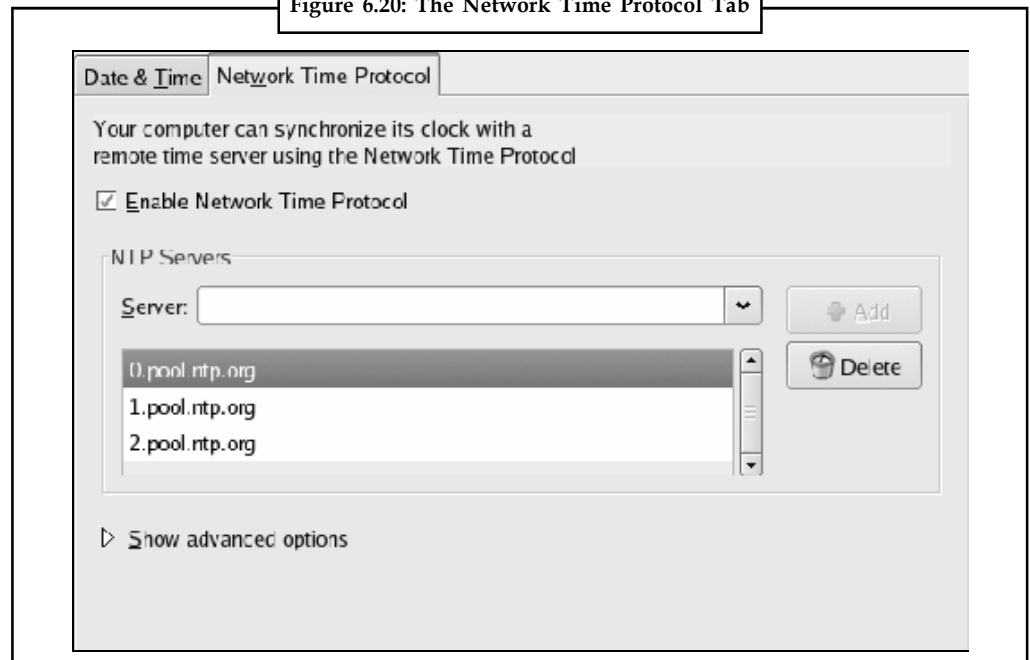

On the Display screen, you can select the type of monitor you're using, the resolution at which you'd like to work, and the color depth. If you can't find your monitor in the list, you can choose Generic CRT Display or Generic LCD Display.

The Setup Agent also provides a screen that allows us to configure an additional user. The user details include a Username, Full Name, and Password, as shown in Figure 6.21.



*Did u know?* If you decide to allow network logins, you can also select that option from this screen.

Figure 6.21: Setting up a System User



## Create User Accounts

As with Windows, it's highly recommended that you create user accounts in addition to the main administration or root account. The root account is omnipotent; it has permissions to create, modify and destroy any file on the system.



*Caution* Performing an action as root without careful forethought can have catastrophic consequences for your system.

Nearly every Linux user can recount in detail the first (and likely only) time they rendered their system inoperable from the root account.

If the Fedora installer found a sound card on your system, you'll be asked to confirm its details. You'll also see a button with which to test it out, though, on a production Web server, this may not be necessary. There's also an Additional Software screen, which you can use to install any extra software you might need. You can just skip this screen for now.

Congratulations, you've now set up a Linux Web server! The graphical installation provides new Linux users with a manageable set of tools to get the system up and running. However, there are cases in which the text mode installation is a quicker and more efficient means to the same end.

## Self Assessment

Fill in the blanks:

- Red Hat's major product line is Red Hat Enterprise Linux (RHEL), which is mostly based on Red Hat's free software distribution, .....

Notes

4. The ..... partition is the home of the kernel.
5. .... is a removable digital data storage medium from which a computer can load and run (boot) an operating system or utility program.
6. .... is a program that will let you select from a list of installed operating systems, then makes the computer start up the selected OS.
7. A swap partition in Linux serves much the same purpose as ..... in Windows.

**6.3 Basics of Windows 7**

Windows 7 is an operating system launched by Microsoft in 2009 as an upgrade from XP or Vista. Windows 7 operating system is one of best choice for many people. If you already purchase the DVD of Windows 7 form any retailer or online store, you can easily install it from the Interactive Setup Wizard of Microsoft’s. You just have to pass several steps to install Windows 7.

Windows 7 can be installed three ways. First and my best choice is to a clean installation (Windows 7 will be the only operating system of your computer). Second way is to upgrade any other Windows (Vista or Windows XP or others) to Windows 7. The third way is the dual-boot where Windows 7 will be installed besides with other operating system and there will be a boot menu at the start-up time to select any operating system to run.

Table 6.2 shows the different versions of windows 7:

**Table 6.2: Different versions of windows 7**

Windows 7 Version	Description
Windows 7 Starter	A stripped-down version of Windows 7 that can only run three programs at a time. This version is ideal for netbooks.
Windows 7 Home Basic	Designed for developing countries, this version adds better graphics and Internet connection sharing to the Starter edition.
Windows 7 Home Premium	Built to fill most consumers’ needs, this version includes programs for watching and recording TV on the PC as well as for creating DVDs from videos.
Windows 7 Professional	Aimed at the business market, this features everything from Home Premium plus tools used by small businesses: extra networking features, for example, and similar business tools.
Windows 7 Enterprise	Microsoft sells this large business version in bulk to large businesses.
Windows 7 Ultimate	This version aims at the wallets of information technology specialists who spend much of their lives in front of their keyboards.

**Self Assessment**

Fill in the blanks:

3. Windows 7 ..... version is designed for developing countries, this version adds better graphics and Internet connection sharing to the Starter edition.
4. Windows 7 ..... version aims at the wallets of information technology specialists who spend much of their lives in front of their keyboards.

## 6.4 Installation of Windows 7

Before installation Windows 7 on your PC, make sure you have a Windows 7 DVD and your hard drive has enough space and well formatted.

Now follow the following steps to install Windows 7 on your computer:

### 6.4.1 Boot-up your PC form the Windows DVD

- At first, insert the Windows DVD into DVD ROM/RAM.
- When the computer will start up, press F8 or F10 or F11 or DEL key to enter the BIOS setup.
- Configure boot options by selecting DVD-ROM drive as the First Boot Priority.
- Now, your computer will try to boot-up from the DVD ROM and the following screen will be appeared.

Figure 6.22: Loading Files



Source: <http://rancidtaste.hubpages.com/hub/Windows-7-Installation-How-to-install-Windows-7-Operating-System-on-Your-Computer-or-PC>

### 6.4.2 Select Language, Time, Currency and Keyboard

Figure 6.23: Select language, time, currency and keyboard from the drop down menu



Source: <http://rancidtaste.hubpages.com/hub/Windows-7-Installation-How-to-install-Windows-7-Operating-System-on-Your-Computer-or-PC>

**Notes**

Wait for some time and then a Install Windows screen will be appeared. Select the language to which you want to install Windows 7 operating system. Later select the time and currency format. At last, you have to select the keyboard. Now, press the **Next** button. It looks like the above figure.

**6.4.3 Install button**

**Install now** button window will be appeared and click that button to start the installation of Windows 7.

Figure 6.24: Click on "Install now" button to begin Windows 7 installation



Source: <http://rancidtaste.hubpages.com/hub/Windows-7-Installation-How-to-install-Windows-7-Operating-System-on-Your-Computer-or-PC>

You will see the message **Setup is starting...** It means, the installation of Windows 7 is started.

Figure 6.25: Setup starting window



Source: <http://rancidtaste.hubpages.com/hub/Windows-7-Installation-How-to-install-Windows-7-Operating-System-on-Your-Computer-or-PC>



### 6.4.4 License Terms Agreement

- Click on the check-box **I agree the license terms** to agree Microsoft software license terms and to install Windows 7 on your PC.
- Click on the **Next** button.

Figure 6.26: Windows 7 license agreement window

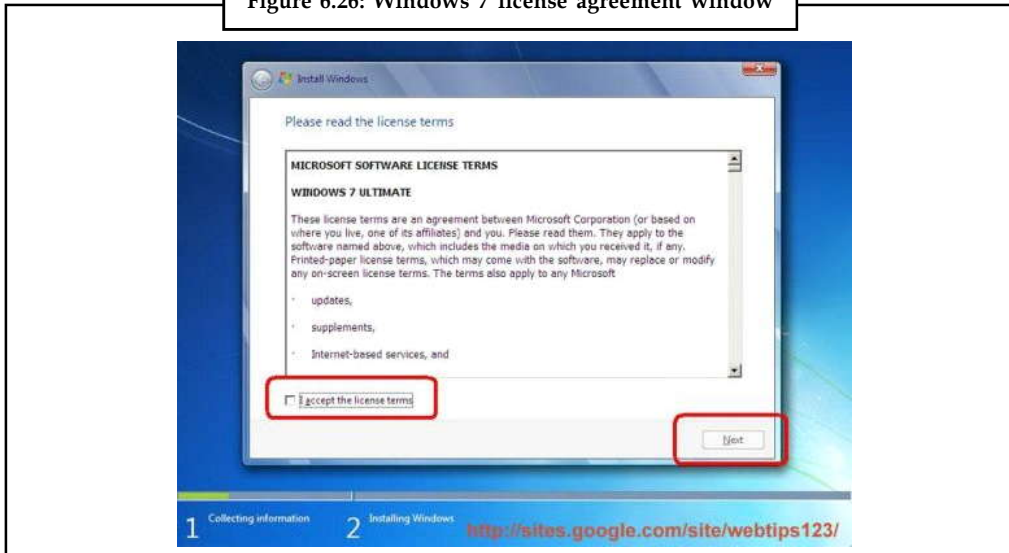

Source: <http://rancidtaste.hubpages.com/hub/Windows-7-Installation-How-to-install-Windows-7-Operating-System-on-Your-Computer-or-PC>

### 6.4.5 Installation Method Selection

You can install Windows 7 by upgrading a newer version of Windows or by installing a new copy of Windows. The second choice is preferred. But if you have many programs on installed, then you may use the first method.

Figure 6.27: Windows 7 Installation Method Selection

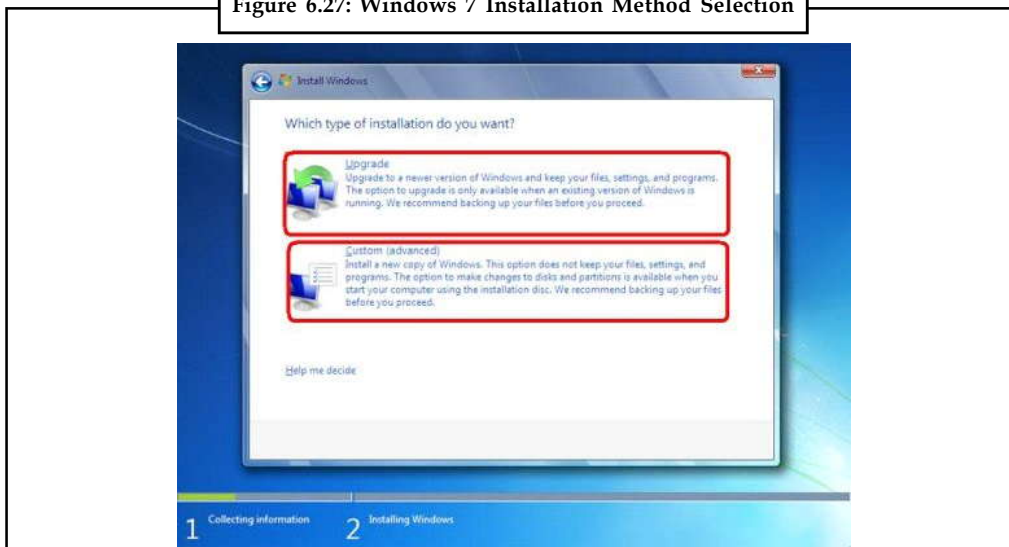

Source: <http://rancidtaste.hubpages.com/hub/Windows-7-Installation-How-to-install-Windows-7-Operating-System-on-Your-Computer-or-PC>

Notes

### 6.4.6 Installation Location Selecton

It's time to select the location of your hard drive to install Windows 7. If your hard drive is a brand new there will be no partition. You may create several partition and then select any partition to install Windows 7. After selecting partition, click on the **Next** button.

Figure 6.28: Hard Drive space allocating for Windows 7

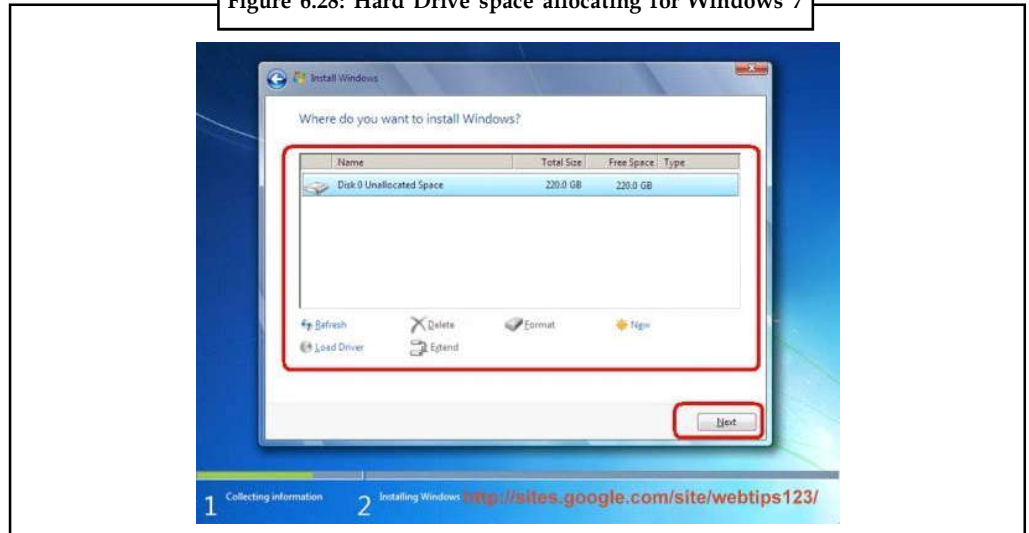

Source: <http://rancidtaste.hubpages.com/hub/Windows-7-Installation-How-to-install-Windows-7-Operating-System-on-Your-Computer-or-PC>

The installation of Windows 7 will be started. It will do the following tasks one by one:

- Copying Windows files
- Expanding Windows files
- Installing features
- Installing updates
- Completing installation

Figure 6.29: Installation Window

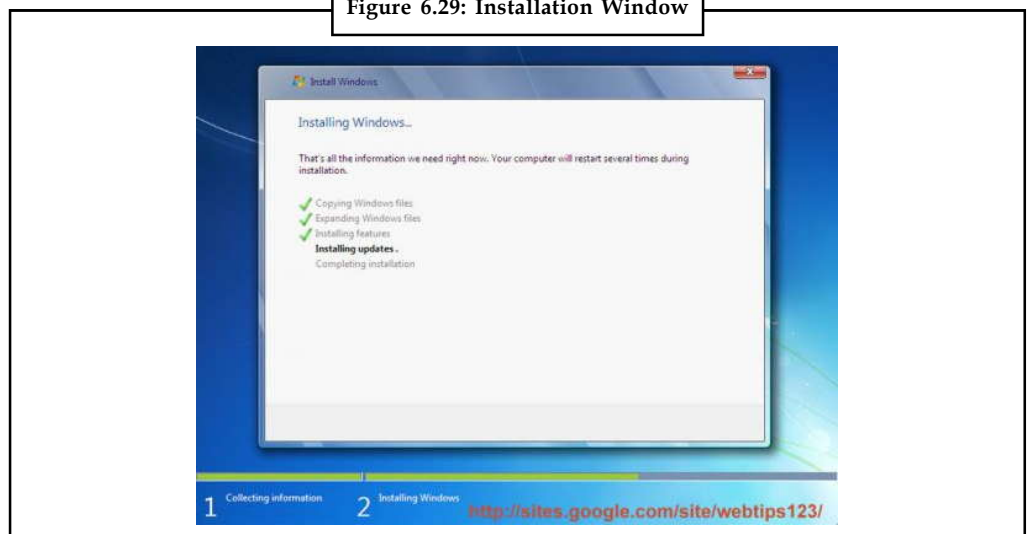

Source: <http://rancidtaste.hubpages.com/hub/Windows-7-Installation-How-to-install-Windows-7-Operating-System-on-Your-Computer-or-PC>

Before finishing the above steps, your PC will be restarted several times. You don't need to do anything until you see the following screen.

Notes

Figure 6.30: Preparing Computer for first use

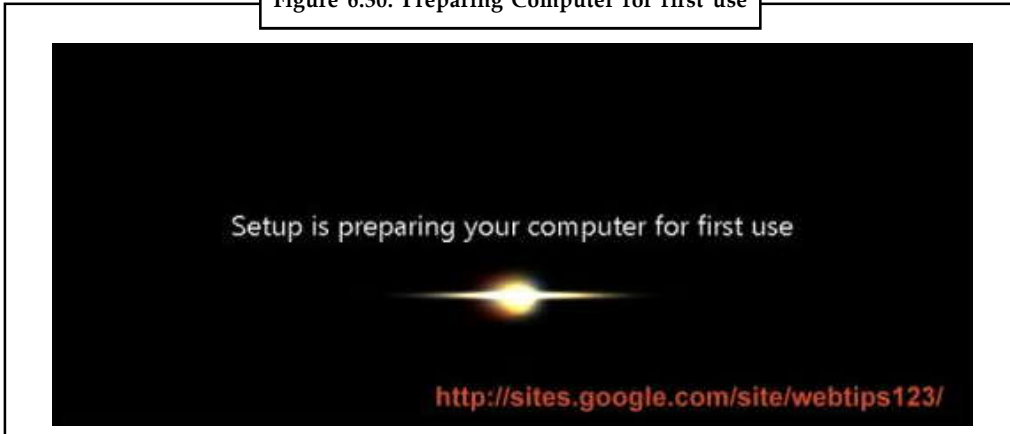

Source: <http://rancid taste.hubpages.com/hub/Windows-7-Installation-How-to-install-Windows-7-Operating-System-on-Your-Computer-or-PC>

Now, you will see the message Setup is checking video performance. Windows 7 will automatically adjust the video performance.

Figure 6.31: Video Performance Checking Window



Source: <http://rancid taste.hubpages.com/hub/Windows-7-Installation-How-to-install-Windows-7-Operating-System-on-Your-Computer-or-PC>

#### 6.4.7 Creating User Name and Computer Name

- Choose an **user name**. The user name will be used to use the computer.
- Type your **computer name**. Computer name will help to distinguish your PC on the network.
- Click **Next** button to advance.
- Give a password of your PC in the Type o password text box which helps protect your user account from unwanted users.
- You have to retype your password. This password must be same as the previous entered password. If don't match, you will see an error message.

Notes

- Type a password hint field helps you to remember your password if you forget your password. It is always recommended to not to fill up this field.
- After doing the above steps, click on Next button.

Figure 6.32: Choosing user name and computer name

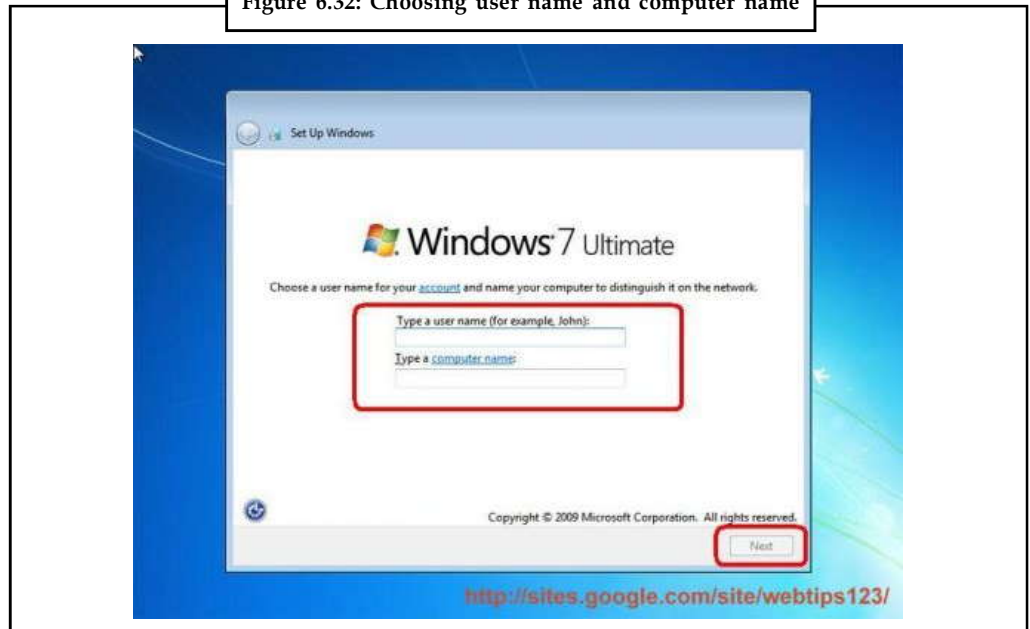

Source: <http://rancidtaste.hubpages.com/hub/Windows-7-Installation-How-to-install-Windows-7-Operating-System-on-Your-Computer-or-PC>

### 6.4.8 Password Setting

Figure 6.33: Placing your password



Source: <http://rancidtaste.hubpages.com/hub/Windows-7-Installation-How-to-install-Windows-7-Operating-System-on-Your-Computer-or-PC>

### 6.4.9 Product Key Installation

- Take you have to insert the product key of Windows 7. You can find it on a label included with the package that came with your copy of Windows. Sometimes, the label might also be on computer case. Just find it and type it in the **PRODUCT KEY** box.
- Click on the **Next** button to move forward.

Figure 6.34: Setting Windows 7 product key



Source: <http://rancid taste.hubpages.com/hub/Windows-7-Installation-How-to-install-Windows-7-Operating-System-on-Your-Computer-or-PC>

### 6.4.10 Choosing the form of Installation

- You will see the message **Help protect your computer and improve Windows automatically**. The first one is recommended i.e. **Use recommended settings**. If you do this all things will be updated and installed. You may update later. Then you can select **Ask me later**.

Figure 6.35: Choosing the form of installation

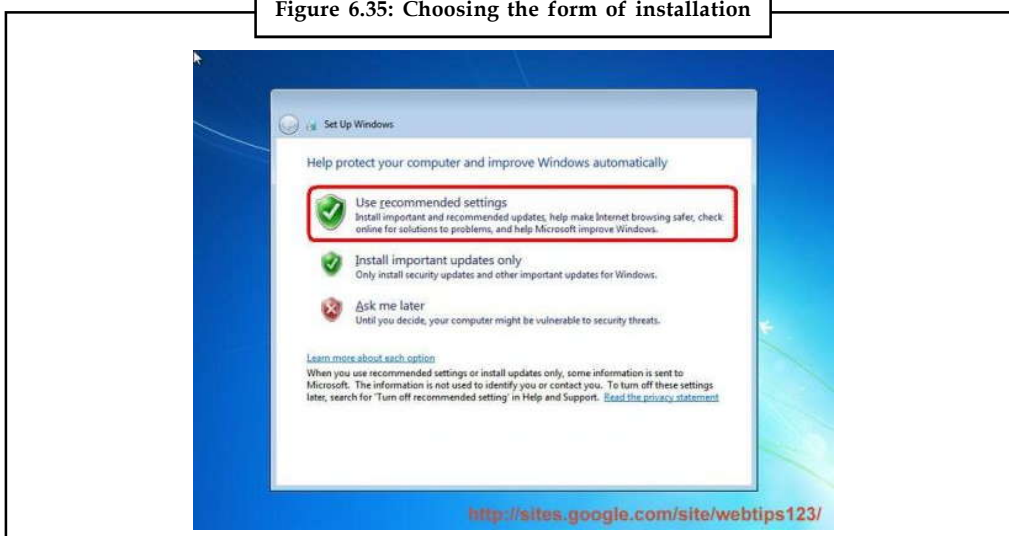

Source: <http://rancid taste.hubpages.com/hub/Windows-7-Installation-How-to-install-Windows-7-Operating-System-on-Your-Computer-or-PC>

Notes

### 6.4.11 Time Settings and Network Settings

- Set your time and date settings.
- Select your computer's current location. It is preferred select **Public network**. It will help you easy installation. Later you can set up your network easily.

Figure 6.36: Setting time and network settings

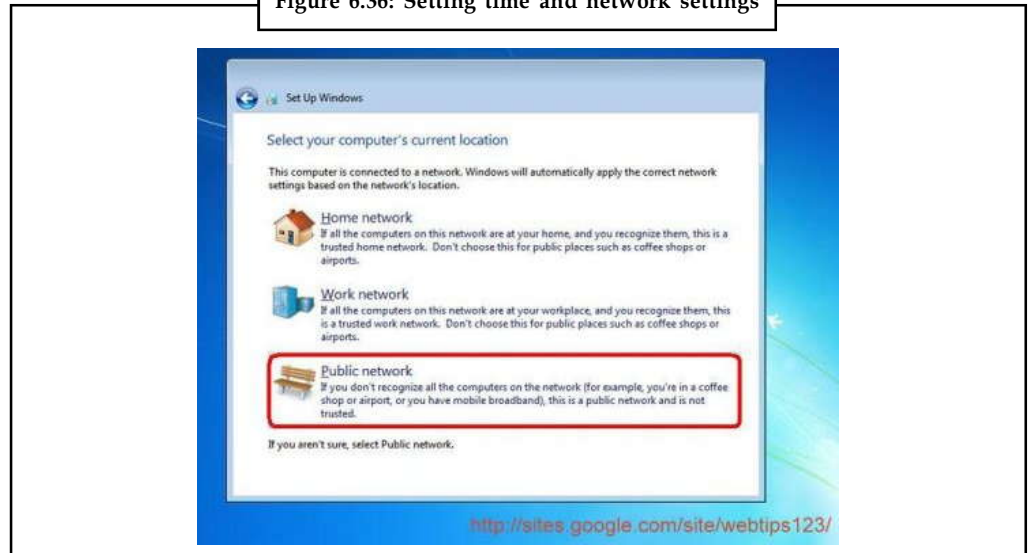

Source: <http://rancid taste.hubpages.com/hub/Windows-7-Installation-How-to-install-Windows-7-Operating-System-on-Your-Computer-or-PC>

### 6.4.12 Defining your PC location

- Your computer may be connected to a network. So, Windows will try to apply the current network settings based on network's location.

Figure 6.37: Defining PC Location

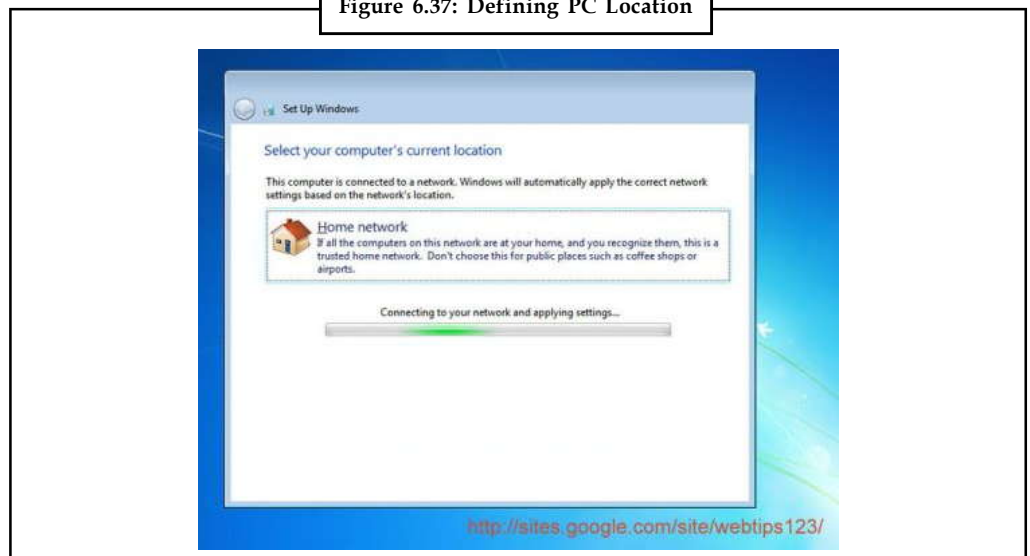

Source: <http://rancid taste.hubpages.com/hub/Windows-7-Installation-How-to-install-Windows-7-Operating-System-on-Your-Computer-or-PC>

### 6.4.13 Finalizing Settings

Notes

- Very soon Windows will finished installing everything and you will see the screen with the message **Windows is finalizing your settings**.

Figure 6.38: Finalizing settings window of Windows 7

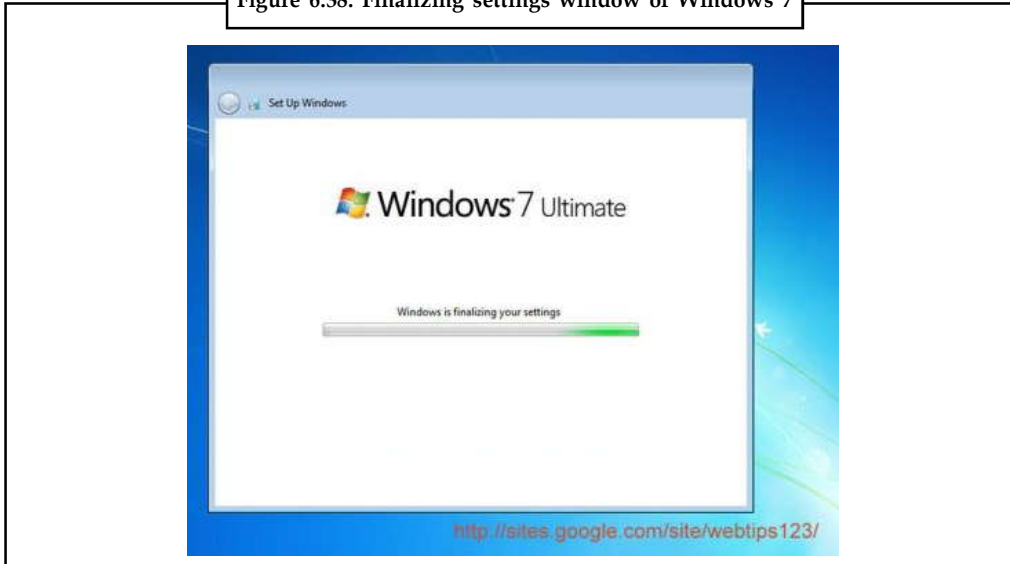

Source: <http://rancid taste.hubpages.com/hub/Windows-7-Installation-How-to-install-Windows-7-Operating-System-on-Your-Computer-or-PC>

### 6.4.14 Opening the desktop

- Now, wait for a few minutes and you will see that the desktop of Windows 7 is in front of you.

Figure 6.39: Desktop of Windows 7

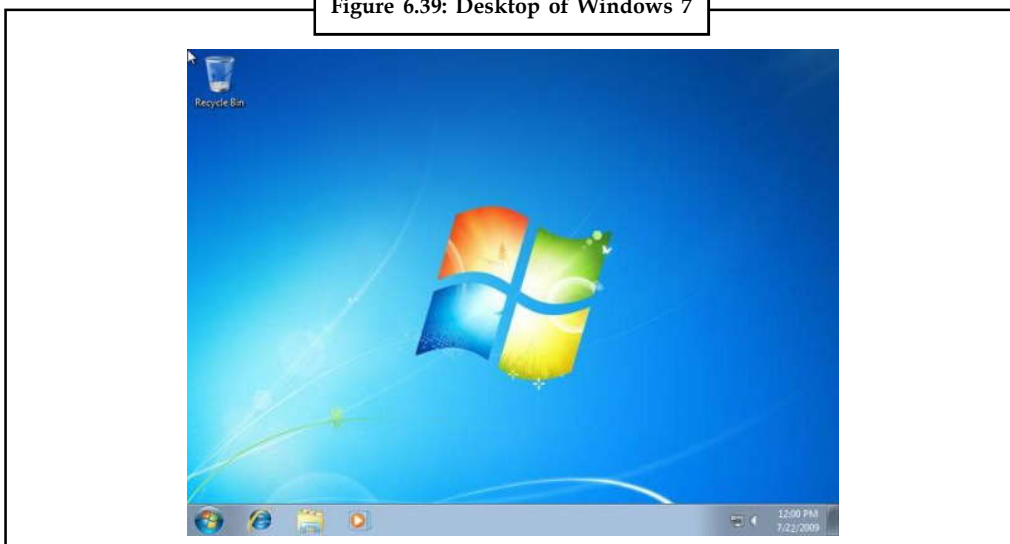

Source: <http://rancid taste.hubpages.com/hub/Windows-7-Installation-How-to-install-Windows-7-Operating-System-on-Your-Computer-or-PC>

By following the above steps, you can easily install Windows 7 on your PC.



Notes

**Self Assessment**

Fill in the blanks:

- 3. If your hard drive is a brand new there will be no .....
- 4. To select your computer's current location, it is preferred to select ..... option.

**6.5 Application/Utility Software**

A utility program performs a specific task, usually related to managing a computer, its devices, or its programs. Most operating systems include several utility programs that perform specific tasks related to managing a computer, its devices, or its programs. These programs work mostly with system resources such as memory and basic data flow. They often help computers organize their memory and set apart memory for applications that are added later in the life of the computer.

Operating systems also use software known as applications, and it can sometimes be difficult to tell what the difference is. In general, utilities are smaller and more simple than applications. Applications are complex and perform many functions instead of only one, often functions that are not directly related to the basic computer structure. Word processors and datasheet programs are two of the most common applications.



*Notes* There are several awesome utilities to make Windows 7 more effective and easier to use. This compilation features all free utilities that will make anything from burning CDs to optimizing Windows 7 easier.

The top utilities for Windows 7 are:

- **Winrar:** Winrar is essential for opening different file types and extensions that you may download from the internet. It's available in both 32-bit and 64-bit and makes extracting zip, rar, and other files a breeze. Winrar also has a skinnable interface, allowing you to change themes if you don't like the default layout.
- **Windows 7 USB DVD Download Tool:** Windows 7 USB DVD Download Tool is a Windows 7 utility that you may not use often, but it will definitely come in handy when you do need it. It allows you to easily create backups of ISO files by burning to DVD or transferring to USB flash drive. This program is lightweight, won't take up much space on your hard drive, and is available directly from Microsoft.
- **Glary Utilities:** Glary Utilities gives you several Windows 7 utilities in one program. Most notably, Glary Utilities improves the performance of your PC by removing junk files that build up on Windows. It features a broken shortcut finder, registry cleaner, trace record remover (Internet Explorer only), and more. Glary Utilities is a top privacy/security program available free for download.
- **VLC Media Player:** Windows Media Player works great for WMV files. But, if you have different media types, such as FLV, you may want to give VLC player a try. It's an easy to use, lightweight application that can play just about every media extension out there. It also has a skinnable interface, allowing you to customize the overall look and feel of the controls. Best of all, VLC Media Player is available completely free.
- **Irfan View:** Irfan View is a Windows 7 utility that allows you to easily edit multimedia. Not only is it a handy photo editor, but MP3 and WMA editor as well. Irfan View is not



near as complex as Adobe Photoshop, but it does allow you to do some quick image editing, such as crop, rotate, blur, etc., quickly and easily.

Notes

- **Frost Wire:** P2P programs aren't for everyone. But, there will come a time when you need to get a file quickly and easily. Frost Wire is one of the best P2P clients available. It's developed using many of the same components as Lime Wire. However, it is less restricted and allows faster downloads, less advertisements, and better simultaneous download efficiency. Frost Wire also has the capability to search Lime Wire's database, making it an ideal P2P file downloading solution.



*Task* Find out some other utilities used in Windows 7.

## Self Assessment

State True or False.

5. A utility program performs a specific task, usually related to managing a computer, its devices, or its programs.
6. Glary utility has the capability to search Lime Wire's database, making it an ideal P2P file downloading solution.

## 6.6 Handling Viruses

In order to run a virus-free Windows PC, follow the following do's and don'ts:

### Do's

- Create an additional user account. Change its type via Control Panel to Limited. Conduct all your work from that account.
- After downloading an application, view its digital signature tab details and verify its validity.
- Use two browsers. Install plug-ins (e.g. Flash) on one of them only! Use the "plug-in equipped" browser (e.g. IE) for entertainment. Use the "bare-bones" browser (e.g. Firefox) for article reading and secure transactions (i.e. online shopping, banking, etc.).
- Always work behind a properly configured router.
- Visit only trusted websites.
- Exercise caution when opening email messages in HTML mode. If you have an antivirus installed, perform a scan on attachment before deciding to open it.
- Install a lightweight antivirus program. Use only one real-time antivirus program.

### Don'ts

- Do not work, read email, or use your Internet browser when logged into an account of the Computer Administrator type.

*Exception:* You must be logged in as Administrator to install new software, to perform updates to Windows and other applications that are installed in your computer, and to configure certain system settings. Keep your Administrator session to minimum.

**Notes**

- Do not install software that triggers the “The publisher could not be verified” warning.
- Do not use only one browser for your entire Internet activity - especially if it has Flash and additional plug-ins installed and enabled, where each component introduces additional potential for a security hole.
- Do not connect to the Internet without a trusted firewall. If you don’t have one, Google “download sygate personal firewall” for a highly recommended free personal firewall for Windows XP. Make sure it is digitally signed, of course. For Windows 7 and Vista, we use the Comodo Firewall.
- Do not visit dubious websites. Exercise careful judgment when deciding to click on that link that shows up in your Google or Bing search results.
- Do not click links in email that comes from unknown sources.
- Do not install an antivirus suite that takes significant resources from your computer and slows it down to the level of being worse than the virus itself.
- Do not install more than one real-time antivirus program.

**Self Assessment**

State True or False:

14. If you have an antivirus installed, perform a scan on attachment before deciding to open it.
15. Do not click links in email that comes from unknown sources.

**6.7 Summary**

- Linux is a powerful, non-proprietary, standards-based operating system that is currently the fastest growing computer operating system on the planet.
- Linux supports a wide range of PC hardware; but not even Linux supports every known device and system.
- Linux provides a means to read the FAT32 (typically used by Windows 98 and ME) or NTFS (usually used by Windows NT, 2000, and XP) filesystems.
- The installation of a Linux system requires a little more up-front research than does a Windows installation.
- The initial installation offers several options. You can choose to install in graphical mode by hitting Enter, or in text mode by typing linux text at the boot: prompt.
- Partitions in Linux appear differently than those in Windows. Linux partitions don’t use the drive letter designations, such as C:, which you may already be used to.
- GRUB is a program that will let you select from a list of installed operating systems, then makes the computer start up the selected OS.
- Windows 7 can be installed three ways. The first way is a clean installation, second choice is upgrade any other Windows to Windows 7, and the third way is the dual-boot.

## 6.8 Keywords

**Boot disk:** It is a removable digital data storage medium from which a computer can load and run (boot) an operating system or utility program.

**Boot loader:** The program which makes multi booting possible is called a boot loader.

**Disk partitioning:** It is the act or practice of dividing the storage space of a hard disk drive into separate data areas known as partitions.

**Dual booting:** It is the act of installing multiple operating systems on a computer, and being able to choose which one to boot when switching on the computer power.

**GRUB:** GRUB is a program that will let you select from a list of installed operating systems, then makes the computer start up the selected OS.

**Installation:** Installation (or setup) of a program (including drivers, plugins, etc.) is the act of putting the program onto a computer system so that it can be executed.

**Operating system:** An Operating System (OS) is a collection of programs that acts as an interface between a user of a computer and the computer hardware.

**Utility program:** A utility program performs a specific task, usually related to managing a computer, its devices, or its programs.

## 6.9 Review Questions

1. How to build dual-boot server on a new computer? Discuss.
2. Discuss the different types of Linux installation methods.
3. Illustrate the steps included in the installation of Linux.
4. Describe the Disk Partitioning process during Linux installation.
5. Illustrate how to set up the Root User.
6. Explain the concept Disk Druid and Swap Space.
7. Discuss the process of installing software packages in Linux.
8. Illustrate the steps used to install windows 7.
9. Discuss various utilities used for Windows 7.
10. Discuss the concept of dealing with computer viruses.

### **Answers: Self Assessment**

- |                    |               |
|--------------------|---------------|
| 1. True            | 2. False      |
| 3. Fedora          | 4. boot       |
| 5. Boot disk       | 6. GRUB       |
| 7. virtual memory  | 8. Home Basic |
| 9. Ultimate        | 10. Partition |
| 11. Public network | 12. True      |
| 13. False          | 14. True      |
| 15. True           |               |

Notes

**6.10 Further Readings**



*Books*

Brian Ward, *How Linux Works*, No Starch Press.

Christopher Negus, *Linux Bible*, Wiley.

Dee-Ann LeBlanc and Richard K. Blum, *Linux for Dummies*.

Ellen Siever, Aaron Weber, Stephen Figgins, Robert Love and Arnold Robbins, *Linux in a Nutshell*, O'Reilly Media.

Wale Soyinka, *Linux Administration: A Beginner's Guide*, McGraw-Hill Osborne Media.



*Online links*

<http://en.kioskea.net/contents/linux/lininst.php3>

[http://wireless.ictp.trieste.it/school\\_2003/docs/linux/linux\\_guides/install\\_guide\\_3.2.pdf](http://wireless.ictp.trieste.it/school_2003/docs/linux/linux_guides/install_guide_3.2.pdf)

<http://www.dedoimedo.com/computers/windows-7-install.html>

<http://www.techtalkz.com/windows-7/514412-windows-7-installation-guide-tutorial.html>

## Unit 7: Networking Basics

Notes

### CONTENTS

Objectives

Introduction

7.1 Different Wires

7.1.1 Twisted Pair (Copper Conductors)

7.1.2 Coaxial Cable

7.1.3 Optical Fiber Cable

7.2 Hubs

7.2.1 Working of Network Hub

7.2.2 Types of Hub

7.2.3 Benefits of Hubs

7.3 Connectors

7.3.1 Types of Connectors

7.4 Punching/Crimping Tools

7.4.1 Punching Tools

7.4.2 Crimping Tools

7.5 Switches

7.5.1 Types of Switches

7.6 I/O Sockets

7.6.1 Point-to-Point Communication

7.6.2 Libraries

7.6.3 Interface Types

7.6.4 Addresses and Ports

7.7 Creation of Cross Wires and Direct Cables

7.7.1 Requirements for Creating Cross Wires and Direct Cables

7.7.2 Creating Cross over Cable

7.7.3 Creating a Direct or Straight through cable

7.8 Summary

7.9 Keywords

7.10 Review Questions

7.11 Further Readings

### Objectives

After studying this unit, you will be able to:

- Explain different wires used in computer network

Notes

- Discuss hubs and connectors
- Discuss Punching/Crimping Tools
- Explain the concept of switches and I/O Sockets
- Describe the creation of cross wires and direct cables

### Introduction

A personal computer serves its purpose well for a single user where all the programs, data, printer and other resources stay attached to it. Most of the home applications require a single computer where you store all your programs and data. However, in many other situations you would like to have other computers attached to your computer so that your computer may interact with those computers. This situation gives rise to computer networking. Computer network can be defined as a group of independent computers possibly located at different physical locations inter-connected with each other so that they can communicate with each other. In data communication system, data is transmitted from computer terminals to the information-processing unit through data communication circuits. Computer networking is a logical follow through of personal computer applications in homes and in small and large enterprises. In this unit, will discuss the basics of computer networking.

### 7.1 Different Wires

Data can be transmitted over a network through a number of different cables. Some of the most frequently used cables are discussed below:

#### **7.1.1 Twisted Pair (Copper Conductors)**

A *twisted pair* as shown in Figure 7.1 is a pair of copper wires, with diameters of 0.4-0.8 mm, twisted together and wrapped with a plastic coating. The twisting increases the electrical noise immunity, and reduces the error rate of the data transmission. Each conductor is separately insulated by some low-smoke and fires retardant substance. Polyethylene, polyvinyl chloride, flouropolymer resin and Teflon® are the some substances that are used for insulation purposes.

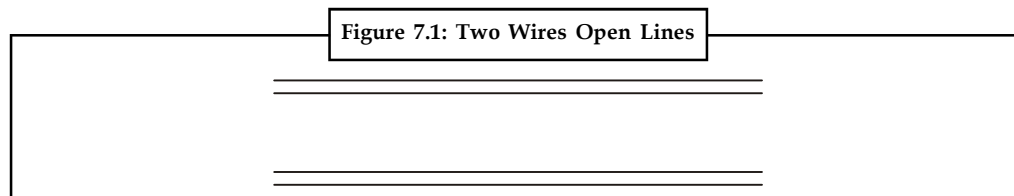

This twisting process serves to improve the performance of the medium by containing the electromagnetic field within the pair. Thereby, the radiation of electromagnetic energy is reduced and the strength of the signal within the wire is improved over a distance. Clearly, this reduction of radiated energy also serves to minimize the impact on adjacent pairs in a multiple cable configuration. This is especially important in high-bandwidth applications, as higher frequency signals tend to lose power more rapidly over distance. Additionally, the radiated electromagnetic field tends to be greater at higher frequencies, impacting adjacent pairs to a greater extent. Generally speaking, the more twists per foot, the better the performance of the wire.

These are popular for telephone network. The energy flow is in guided media. Metallic wires were used almost exclusively in telecommunications networks for the last 80 years, until the development of microwave and satellite radio communications systems. Therefore, copper wire is now a mature technology, rugged and inexpensive. In certain applications, copper-

covered steel, copper alloy, nickel- and/or gold-plated copper and even aluminum metallic conductors are employed.

The maximum transmission speed is limited in this case. The copper conductor that carries analogue data can be used to carry digital data also in association with Modem. Modem is a device to convert digital signal into analog signal and vice versa. The data rate in this category is limited to around 28 Kbps.



*Did u know?* The introduction of the Integrated Services Digital Network (ISDN) led to the use of improved modulation and coding schemes and data rate up to 128 Kbps.

Local Area Networks (LANs) also use twisted pairs. These networks also upgraded to support for high bit rate real time multimedia. A recent development is Asymmetric Digital Subscriber Lines (ADSL) technology which is aimed at using two wire copper loops at data rates of 1.544 Mbps in the network to user direction and about 600 Kbps from the user to network.

The twisted pair cable may be defined in two categories based upon the shielding and without shielding.

### Unshielded Twisted Pair (UTP)

UTP as depicted in Figure 7.2 is the copper media, inherited from telephony, which is being used for increasingly higher data rates, and is rapidly becoming the de facto standard for horizontal wiring. Horizontal wiring specifies the connection between, and including, the outlet and the termination in the communication closet. The horizontal is limited to a maximum of 90 meters. This is independent of the media type so that the communication closet is common to all media and all applications operating over the media. In addition, there is an allowance for 3 meters in the work area and 6 meters for cross connecting in the closet for a total of 99 meters.

The recommended media and connectors for the horizontal are as follow:

- 100-ohm unshielded twisted pair - 4 pairs, 8-pin modular connector (ISDN).
- 150-ohm shielded twisted pair - 2 pairs (IBM connector or RJ45).
- 50-ohm coax (thin) - IEEE 10BASE2, standard BNC connector.
- 62.5/125 multi mode fiber.

A UTP cable contains from 2 to 4200 twisted pairs. The advantages of UTP are the flexibility, low cost media, and can be used for either voice or data communications. Its greatest disadvantage is the limited bandwidth, which restricts long distance transmission with low error rates.

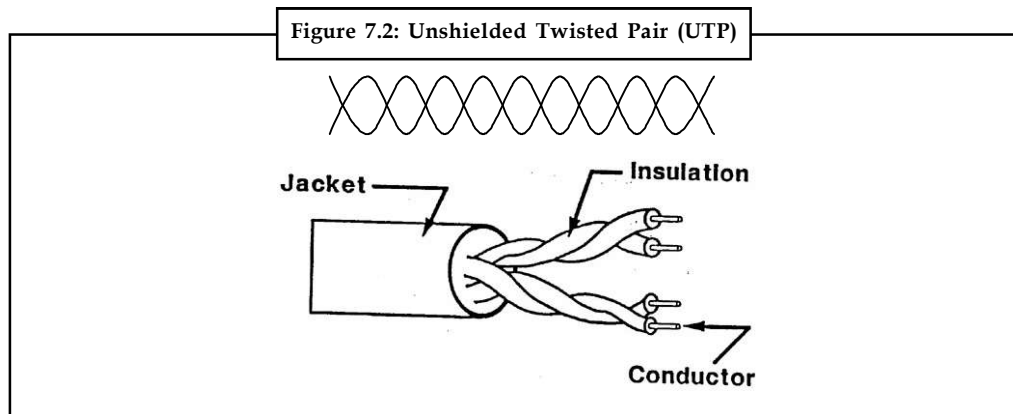

Notes

**Shielded Copper or STP**

Shielded Twisted Pair (STP) differs from UTP in that a metallic shield or screen surrounds the pairs, which may or may not be twisted. As illustrated in Figure 7.3, the pairs can be individually shielded. A single shield can surround a cable containing multiple pairs or both techniques can be employed in tandem. The shield itself is made of aluminum, steel, or copper. This is in the form of a metallic foil or woven meshes and is electrically grounded. Although less effective, the shield sometimes is in the form of nickel and/or gold plating of the individual conductors.

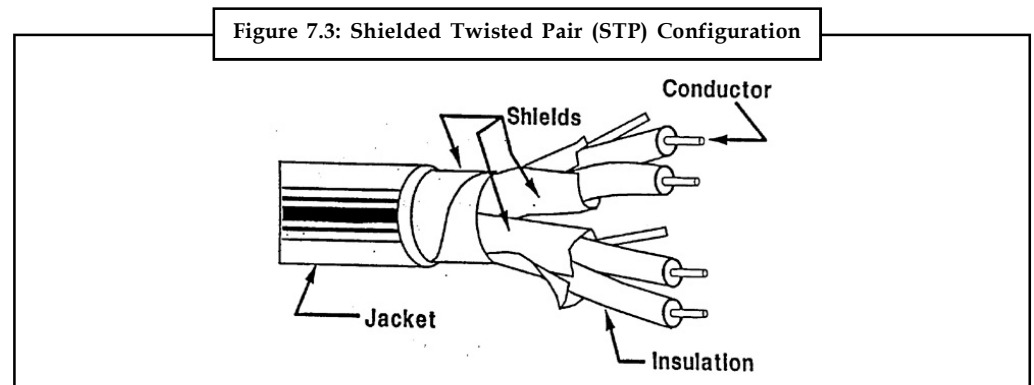

Shielded copper offers the advantage of enhanced performance for reasons of reduced emissions and reduction of electromagnetic interference. Reduction of emissions offers the advantage of maintaining the strength of the signal through the confinement of the electromagnetic field within the conductor. In other words, signal loss is reduced. An additional benefit of this reduction of emissions is that high-frequency signals do not cause interference in adjacent pairs or cables. Immunity from interference is realized through the shielding process, which reflects electromagnetic noise from outside sources, such as electric motors, other cables and wires, and radio systems.

Shielded twisted pair, on the other hand, has several disadvantages. First, the raw cost of acquisition is greater as the medium is more expensive to produce. Second, the cost of deployment is greater as the additional weight of the shield makes it more difficult to deploy. Additionally, the electrical grounding of the shield requires more time and effort.

**General Properties of Twisted Pair**

Some general properties of twisted pair are given below:

1. **Gauge:** Gauge is a measure of the thickness of the conductor. The thicker the wire, the less the resistance, the stronger the signal over a given distance, and the better the performance of the medium. Thicker wires also offer the advantage of greater break strength. The gauge numbers are retrogressive.



*Caution* The larger is the number, the smaller is the conductor.

2. **Configuration:** In a single pair configuration, the pair of wires is enclosed in a sheath or jacket, made of polyethylene, polyvinyl chloride or Teflon. Usually, multiple pairs are so bundled in order to minimize deployment costs associated with connecting multiple devices (e.g., electronic PBX or KTS telephone sets, data terminals, and modems) at a single workstation.



3. **Bandwidth:** The effective capacity of twisted pair cable depends on several factors, including the gauge of the conductor, the length of the circuit and the spacing of the amplifiers/repeaters. One must also recognize that a high-bandwidth (high frequency) application may cause interference with other signals on other pairs in close proximity.
4. **Error Performance:** Signal quality is always important, especially relative to data transmission. Twisted pair is especially susceptible to the impacts of outside interference, as the lightly insulated wire act as antennae and, thereby, absorbs such errant signals. Potential sources of Electro Magnetic Interference (EMI) include electric motors, radio transmissions and fluorescent light boxes. As transmission frequency increases, the error performance of copper degrades significantly with signal attenuation increasing approximately as the square root of frequency.
5. **Distance:** Twisted pair is distance limited. As distance between network elements increases, attenuation (signal loss) increases and quality decreases at a given frequency. As bandwidth increases, the carrier frequency increases, attenuation becomes more of an issue, and amplifiers/repeaters must be spaced more closely.
6. **Security:** Twisted pair is inherently an insecure transmission medium. It is relatively simple to place physical taps on UTP. Additionally, the radiated energy is easily intercepted through the use of antennae or inductive coils, without the requirement for placement of a physical tap.
7. **Cost:** The acquisition, deployment and rearrangement costs of UTP are very low, at least in inside wire applications. In, high-capacity, long distance applications, such as inter-office trunking, however, the relative cost is very high, due to the requirements for trenching or boring, conduit placement, and splicing of large, multi pair cables. Additionally, there are finite limits to the capacity and other performance characteristics of UTP, regardless of the inventiveness of technologists. Hence, the popularity of alternatives such as microwave and fiber-optic cable.
8. **Applications:** UTP's low cost including recently developed methods of improving its performance has increased its application in short-haul distribution systems or inside wire applications. Current and continuing applications include the local loop, inside wire and cable, and terminal-to-LAN. Generally speaking, UTP no longer is deployed in long haul or outside the premises transmission systems.

The additional cost of shielded copper limits its application to inside wire applications. Specifically, it generally is limited to application in high-noise environments. It also is deployed where high frequency signals are transmitted and there is concern about either distance performance or interference with adjacent pairs.



*Example:* LANs and image transmission.

### 7.1.2 Coaxial Cable

Coaxial cable is the kind of copper cable used by cable TV companies between the community antenna and user homes and businesses. Coaxial cable is sometimes used by telephone companies from their central office to the telephone poles near users. It is also widely installed for use in business and corporation Ethernet and other types of local area network.

Coaxial cable is called "coaxial" because it includes one physical channel that carries the signal surrounded (after a layer of insulation) by another concentric physical channel, both running along the same axis. The outer channel serves as a ground. Many of these cables or pairs of

Notes

coaxial tubes can be placed in a single outer sheathing and, with repeaters, can carry information for a great distance.

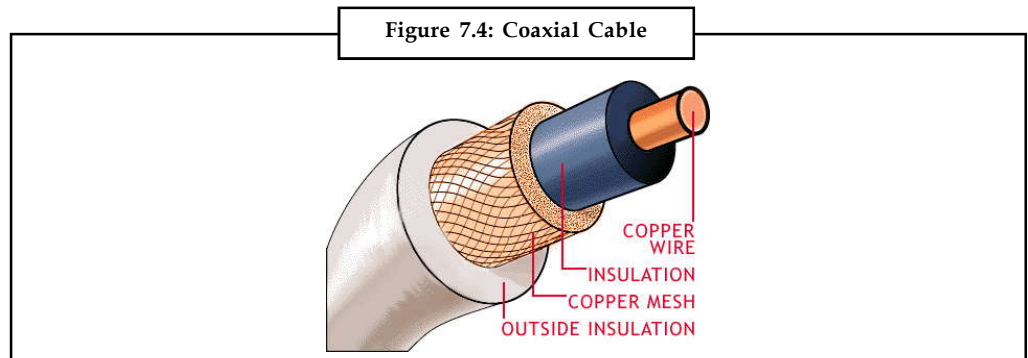

Coaxial cable was invented in 1929 and first used commercially in 1941. AT&T established its first cross-continental coaxial transmission system in 1940. Depending on the carrier technology used and other factors, twisted pair copper wire and optical fiber are alternatives to coaxial cable.

*There are two types of coaxial cabling:* thinnet and thicknet. Thinnet is a flexible coaxial cable about 1/4 inch thick. Thinnet is used for short-distance. Thinnet connects directly to a workstation's network adapter card using a British Naval Connector (BNC). The maximum length of thinnet is 185 meters. Thicknet coaxial is thicker cable than thinnet. Thicknet cable is about 1/2 inch thick and can support data transfer over longer distances than thinnet. Thicknet has a maximum cable length of 500 meters and usually is used as a backbone to connect several smaller thinnet-based networks.

The bandwidth for coaxial cable is 10 mbps (mega bits per second).

*Task* Compare and contrast thinnet and thicknet coaxial cables.

### 7.1.3 Optical Fiber Cable

As the geometry of coaxial cable significantly reduces the various limiting effects, the maximum signal frequency, and hence the information rate that can be transmitted using a solid conductor, although very high, is limited. This is also the case for twisted lines. Optical fiber differs from both these transmission media in that it carries the transmitted information in the form of a fluctuating beam of light in a glass fiber rather than as an electrical signal on a wire. This type of transmission has become strong support for digital network owing to its high capacity and other factors favorable for digital communication.

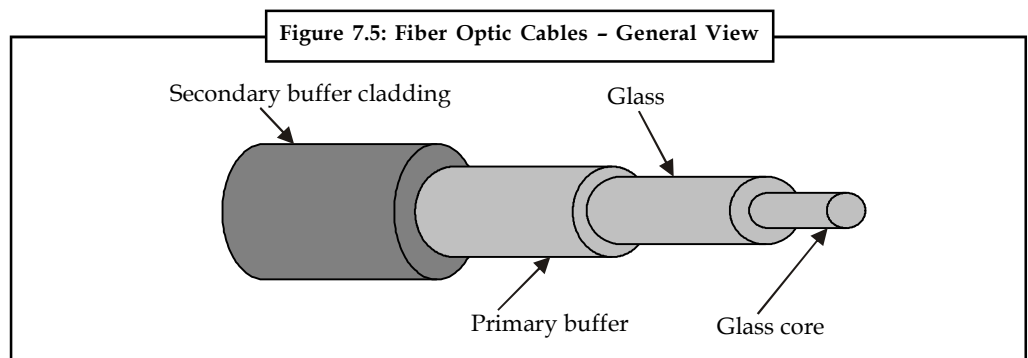

Fiber optic transmission systems are opto-electric in nature. In other words, a combination of optical and electrical electromagnetic energy is involved. The signal originates as an electrical signal, which is translated into an optical signal, which subsequently is reconverted into an electrical signal at the receiving end. Thin glass fiber as shown in Figure 7.5 is very clear and designed to reflect light internally for efficient transmission carries light with encoded data. Plastic jacket allows fiber to bend (some!) without breaking. *Light Emitting Diode* (LED) or *laser* injects light into fiber for transmission. Light sensitive receiver at other end translates light back into data.

The optical fiber consists of a number of substructures as shown in Figure 7.6. In this case, a core made of glass, which carries most of the light is surrounded by a cladding made of glass with lower refractive index. This bends the light and confines it to the core. The core is surrounded by a substrate layer (in some fibers) of glass, which does not carry light, but adds to the diameter and strength of the fiber. A primary buffer coating and a secondary buffer coating to provide mechanical protection cover all these.

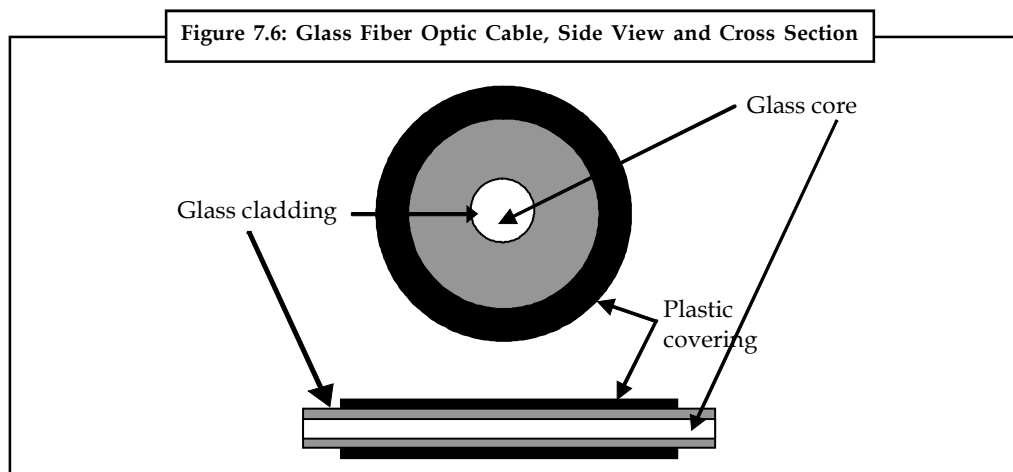

The light pulse travels down the center core of the glass fiber. Surrounding the inner core is a layer of glass cladding, with a slightly different refractive index. The cladding serves to reflect the light waves back into the inner core. Surrounding the cladding is a layer of protective plastic coating that seals the cable and provides mechanical protection. This is shown in Figure 7.6. Typically, multiple fibers are housed in a single sheath, which may be heavily armored.



*Example:* Fiber-optic cables are used in the telephone system, the cable TV system or the Internet. Fiber-optic cables are basically the strands of optically pure glass that carry long distances digital information. Optical cables appears to be as thin as human hair.



*Example:* Optical fibers are also used in mechanical engineering inspection and medical inspection.

Light propagates along the optical fiber core in one of the following ways as given below depending on the type and width of core material used.

- **Multimode Fiber:** In the case of a multimode fiber, the core diameter is relatively large compared to a wavelength of light. Core diameter range from 50 micrometers ( $\mu\text{m}$ ) to 1,000  $\mu\text{m}$ , compared to the wavelength of light of about 1  $\mu\text{m}$ . This means that light can propagate through the fiber in many different ray paths, or modes, hence the name multimode.

## Notes

Multimode fiber is less expensive to produce and inferior in performance because of the larger diameter of the inner core. When the light rays travel down the fiber, they spread out due to a phenomenon known as modal dispersion. Although reflected back into the inner core by the cladding, they travel different distances and, therefore, arrive at different times. The received signal thus has a wider pulse width than the input signal with a corresponding decrease in the speed of transmission. As a result, multimode fiber is relegated to applications involving relatively short distances and lower speeds of transmission, for example, LANs and campus environments.

Two basic types of multimode fibers exist. The simpler and older type is a "step index" fiber, where the index of refraction (the ability of a material to bend light) is the same all across the core of the fiber.

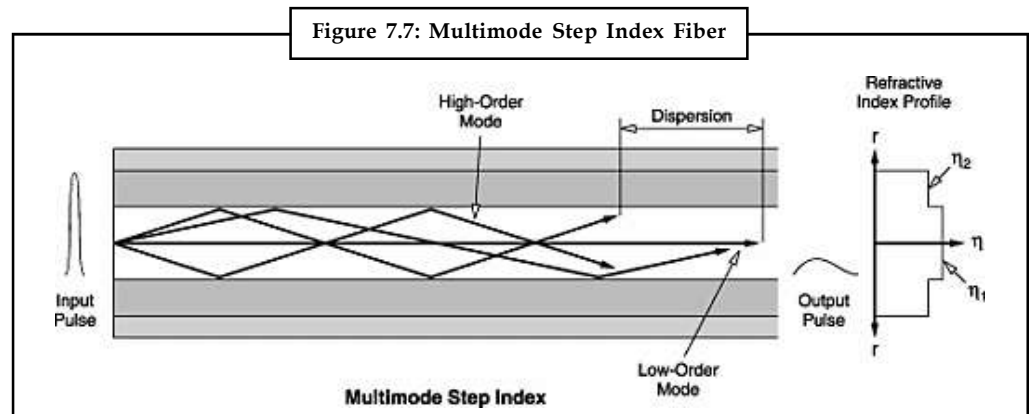

- ❖ *Step Index Multimode Fiber:* This is shown in Figure 7.7. With all these different ray paths or modes of propagation, different rays travel different distances, and take different amounts of time to transit the length of a fiber. This being the case, if a short pulse of light is injected into a fiber, the various rays emanating from that pulse will arrive at the other end of the fiber at different times, and the output pulse will be of longer duration than the input pulse. This phenomenon is called "modal dispersion" (pulse spreading), and limits the number of pulses per second that can be transmitted down a fiber and still be recognizable as separate pulses at the other end. This, therefore, limits the bit rate or bandwidth of a multimode fiber. For step index fibers, wherein no effort is made to compensate for modal dispersion, the bandwidth is typically 20 to 30 MHz over a length of one kilometer of fiber, expressed as "MHz - km".
- ❖ *Graded Index Multimode Fiber:* In the case of a graded index multimode fiber, the index of refraction across the core is gradually changed from a maximum at the center to a minimum near the edges, hence the name graded index. This design takes advantage of the phenomenon that light travels faster in a low-index-of-refraction material than a high-index material. If a short pulse of light is launched into the graded index fiber, it may spread some during its transit of the fiber, but much less than in the case of a step index fiber. Therefore, dispersion can be reduced using a core material that has a variable refractive index. In such multimode graded index fiber light is refracted by an increasing amount as it moves away from the core as shown in Figure 7.8. This has the effect of narrowing the pulse width of the received signal compared with stepped index fiber, allowing a corresponding increase in the speed of transmission. They therefore can support a much higher bit rate or bandwidth. Typical bandwidths of graded index fibers range from 100 MHz-km to well over 1GHz-km. The actual bandwidth depends on how well a particular fiber's

index profile minimizes modal dispersion, and on the wavelength of light launched into the fiber.

Figure 7.8: Light Propagation in Multimode Graded Index Fiber

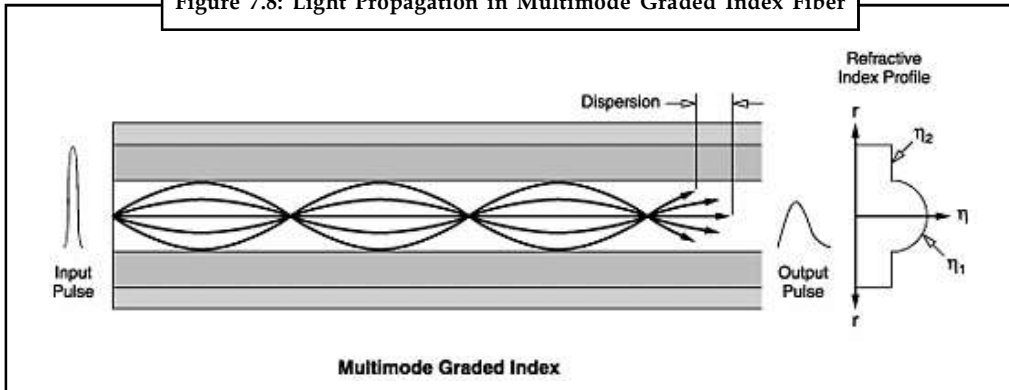

- Monomode/Singlemode fiber:** This has a thinner inner core. In this case, the core diameter of about  $9\ \mu\text{m}$  is much closer in size to the wavelength of light being propagated, about  $1.3\ \mu\text{m}$ . This limits the light transmission to a single ray or mode of light to propagate down the core of the fiber as shown in Figure 7.9. All the multiple-mode or multimode effects described above are eliminated. However, one pulse-spreading mechanism remains. Just as in the multimode fibers, different wavelengths of light travel at different speeds, causing short pulses of light injected into the fiber to spread as they travel. This phenomenon is called "chromatic dispersion".

Figure 7.9: Light Propagation in Single Mode Step Index Fiber

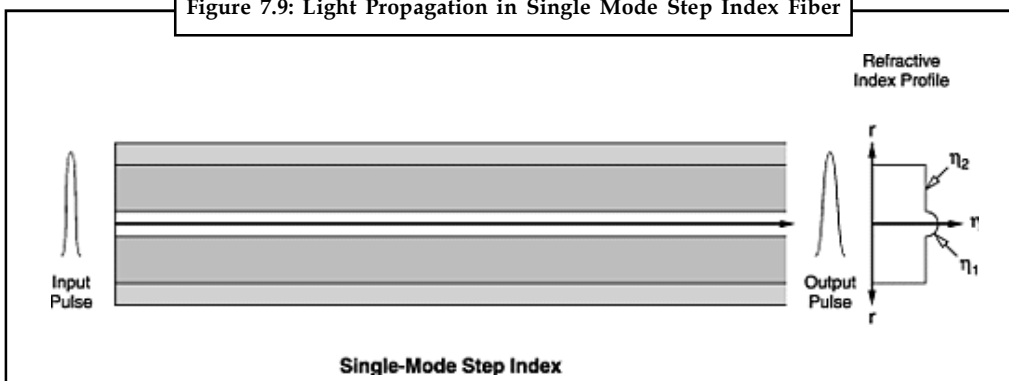

It performs better than does multimode fiber over longer distances at higher transmission rates. Due to reduced core diameter all the emitted light propagates along a single path. Consequently the received signal is of a comparable width to the input signal. Although more costly, monomode fiber is used to advantage in long haul and especially in high bandwidth, applications.

Single-mode fibers have the very broadest bandwidth, lowest cost and lowest attenuation of any available optical fiber. Therefore, they are universally used in long-distance telephony and cable television applications.

#### Advantages of optical fibers may be listed as:

- Immunity to electromagnetic interference and crosstalk
- No electrical ground loop or short circuit problems
- Small size and light-weight

Notes

- Large bandwidth for size and weight
- Safe in combustible areas (no arcing)
- Immunity to lightning and electrical discharges
- Longer cable runs between repeaters
- Flexibility and high strength
- Potential high temperature operation
- Secure against signal leakage and interference
- No electrical hazard when cut or damaged

General Properties of Optical Fiber

General properties of optical fiber are given below:

- **Configuration:** Fiber optic systems consist of light sources, cables and light detectors, as depicted in Figure 7.10. In a simple configuration, one of each is used. In a more complex configuration over longer distances, many such sets of elements are employed. Much as is the case in other transmission systems, long haul optical communications involves a number of regenerative repeaters. In a fiber optic system, repeaters are opto-electric devices. On the incoming side of the repeater, a light detector receives the optical signal, converts it into an electrical signal, boosts it, converts it into an optical signal, and places it onto a fiber, and so on. There may be many such optical repeaters in a long haul transmission system, although typically far fewer than would be required using other transmission media.

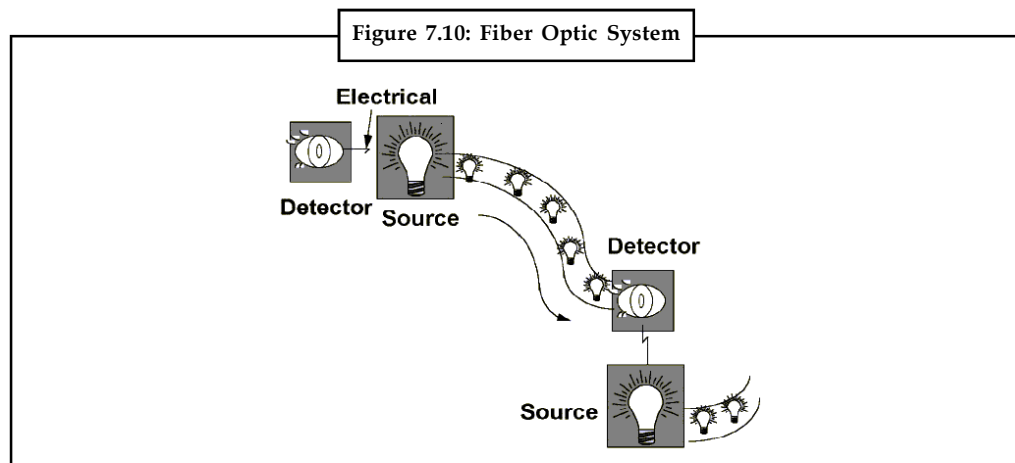

- **Bandwidth:** Fiber offers by far the greatest bandwidth of any transmission system, often in excess of 2 Gbps in long haul carrier networks. Systems with 40 Gbps have been tested successfully on numerous occasions. The theoretical capacity of fiber is in the terabit (Tbps) range, with current monomode fiber capacity being expandable to that level.
- **Error Performance:** Fiber being a dielectric (a nonconductor of direct electric current), it is not susceptible to Electro Magnetic Interference/Radio Frequency Interference (EMI/RFI). This also does not emit EMI/RFI. The light signal will suffer from attenuation, although less so than other media. Scattering of the optical signal, bending in the fiber cable, translation of light energy to heat, and splices in the cable system can cause such optical attenuation.

- **Distance:** Monomode fiber optic systems routinely are capable of transmitting signals over distances in excess of 325 km. Therefore, relatively few optical repeaters are required in a long-haul system. This will reduce costs, and eliminating points of potential failure.
- **Security:** Fiber is intrinsically secure, as it is virtually impossible to place a physical tap without detection because no light is radiated outside the cable. Therefore, interception of signal is almost impossible. Additionally, the fiber system supports such a high volume of traffic that it is difficult to intercept and distinguish a single transmission from the tens of thousands of other transmissions that might ride the same cable system. The digital nature of most fibers, coupled with encryption techniques frequently are used to protect transmission from interception, make fibers highly secure.
- **Cost:** While the acquisition, deployment, and rearrangement costs of fiber are relatively high, the immense bandwidth can outweigh that cost in bandwidth-intensive applications. At Gbps speeds, a single set of fibers can carry huge volumes of digital transmissions over longer distances than alternative systems, thereby lowering the transport cost per bit and cost per conversation to fractions of a penny per minute.
- **Applications:** Applications for fiber optic transmission systems are bandwidth intensive. Such applications include backbone carrier networks, international submarine cables, backbone LANs (FDDI), interoffice trunking, computer-to-computer distribution networks (CATV and Information Superhighway) and fiber to the desktop (Computer Aided Design)

## Self Assessment

Fill in the blanks:

1. .... is a measure of the thickness of the conductor.
2. .... is a flexible coaxial cable which is used for short-distance.
3. In the case of a ..... multimode fiber, the index of refraction across the core is gradually changed from a maximum at the center to a minimum near the edges.

## 7.2 Hubs

Hubs are straightforward network devices, and their straightforwardness is reflected in their low cost. Small hubs with four or five ports (frequently known as workgroup hubs) cost less than \$50; with the necessary cables, they give everything required to generate a small network. Hubs with more ports are obtainable for networks that need greater capacity. Computers attach to a hub by means of a length of twisted-pair cabling. In addition to ports for linking computers, even an economical hub generally has a port selected as an uplink port that facilitates the hub to be associated to another hub to create larger networks.

Basically the hub consists of the box that should be of rectangular shape made up of plastic to make it unbreakable. A power cable is connected to the hub for giving the power to the device from the ordinary source. Different types of ports are configured in the hub box of the sake of the connection of different networks through network cables. Minimum at least four systems are connected with a single small hub.



*Did u know?* The larger hub has ability to connect more than 20 ports at a single time and can provide working to all users.

Notes

### 7.2.1 Working of Network Hub

Working of the networking hub depends upon its construction and the types that is used for the networking. Basically the main function of the hub is to connect the multi computers with the single device and then perform like a single network. Different computers are connected with the hub with the help of individual ports and then perform different type o networking tasks as a single network. The main responsibility of the hub is to amplify the data in the form of electrical signals and then broadcast the data over the network. A big advantage of the hub is to share the different applications without the individual access and can share the resources with the help of hub. So hub provides a convenient and easy networking for all the users connected to the device.

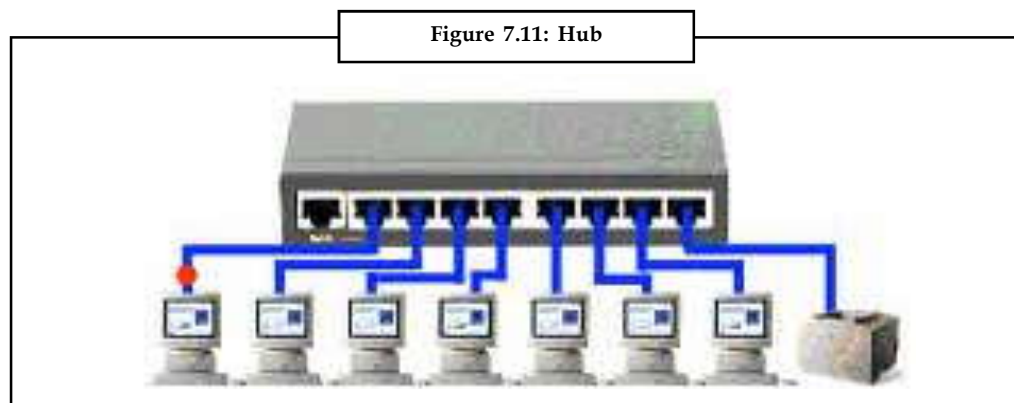

Figure 7.11: Hub

### 7.2.2 Types of Hub

On the basis of working and the performance networking hub is differentiated into the three different types. The brief descriptions of these three types are as follows:

#### Passive Hub

The first type of the networking hub is the passive hub. Passive hub does not perform any particular function but it just behaves like a bridge between the cables of connection and just receives the information and forwards it with out any change in topology.

#### Active Hub

Second type of the networking hub is the active hub. This type of hub is quite similar to that of the passive hub but can perform the additional tasks. Active hubs are those hubs that can work as connector between two regions but also has ability to regenerate the information with the help of strong electrical signals. it is also called as the multi port repeater. It helps in the communication and can upgrade the properties of the signals before delivery.

#### Intelligent Hub

The third and the last type of the hub that can perform the both functions of the active and the passive hub is generally referred to as the intelligent hub. Basically this hub provides the opportunity to increase the speed of networking and also make the performance of the network efficient as compared to other devices. Addition to their specific work intelligent hubs can also perform the different functions that of routing, bridging etc.



### 7.2.3 Benefits of Hubs

Notes

There are many advantages of the networking computer hubs. Some of the important benefits are as follows:

1. With the help of hubs we can create a home network easily.
2. Hubs can also monitor the whole network in a real inexpensive way.
3. It also provide the opportunity to the users to connect their old devices with their hub drives.

### Self Assessment

Fill in the blanks:

4. The main function of the ..... is to connect the multi computers with the single device and then perform like a single network.
5. Active hub is also called as the .....

### 7.3 Connectors

Connector is a simple device that physically links, couples, or connects, two things together. Connectors can be classified as male connectors and female connectors.

A male connector is a connector attached to a wire, cable, or piece of hardware, having one or more exposed, unshielded electrical terminals, and constructed in such a way that it can be inserted snugly into a receptacle ( female connector ) to ensure a reliable physical and electrical connection . This type of connector is also known as a plug. A male connector can be recognized by the fact that, when it is disconnected or removed, the unshielded electrical prongs are plainly visible.

The most common male connector is a two- or three-prong plug attached to the end of the cord for an electrical appliance.

Other common examples include the plugs for headsets, most connectors on the ends of lengths of coaxial cable , and the edge connectors on some printed circuit cards. D-shell connectors for computer serial and parallel ports can also be male.

A female connector is a connector attached to a wire, cable, or piece of hardware, having one or more recessed holes with electrical terminals inside, and constructed in such a way that a plug with exposed conductors ( male connector ) can be inserted snugly into it to ensure a reliable physical and electrical connection . A female connector is also known as a jack, outlet, or receptacle. This type of connector can be recognized by the fact that, when it is disconnected or removed, the electrical conductors are not directly exposed, and therefore are not likely to make accidental contact with external objects or conductors.

The most common female connector is a two- or three-prong electrical outlet, also known as a wall outlet.

Other often-encountered examples include telephone jacks , the jacks for headsets, the chassis connectors for coaxial cable, and some D-shell connectors for computer serial and parallel ports.



*Notes* A gender changer is a hardware device used to convert a male connector to a female connector, or *vice versa*.

Notes

### 7.3.1 Types of Connectors

Without cable connectors, networks would be limited to a few machines in very close proximity, because the signal strength traveling down a network cable gradually diminishes until it is too small to be of any use. Cable connectors easily connect bridges and routers, which boost signal strength, enabling large-scale networks. There are several different types of data cables, and each one has its own type of connector.

- **RJ-45:** These connectors are used with unshielded twisted pair—UTP—cables and look similar to a telephone plug. Although they can be wired to a cable by hand, this is very time-consuming and error-prone. Most UTP network cables are sold in various lengths with RJ-45 connectors already attached. Attaching two UTP cable network segments together requires the use of a hardware device containing sockets that accept the RJ-45 connector.
- **BNC:** The BNC (British Naval Connector) is used to connect coaxial Ethernet network cables. A connector is attached to each end of a cable with a crimping tool, and each one has a metal connector with a pin in its center and a metal shroud surrounding it. To connect two cables, a female connector is used. This is a small cylindrical component with a connector at each end. The male connector on the cable is twisted in place and held firm by two metal lugs, located on the female part.
- **Fiber Optic:** Fiber optic cables use light instead of electricity to transmit data, which gives them a speed advantage over traditional network cabling technologies. Connecting optic fiber cables is more complicated and can require specially trained technicians. Epoxy resin is injected into a housing containing the cable and heated to form the connection. More modern connectors are being developed, reducing the connection time, but the epoxy resin method is still widely used because it produces extremely robust connections.

### Self Assessment

Fill in the blanks:

6. .... is a simple device that physically links, couples, or connects, two things together.
7. A ..... is a hardware device used to convert a male connector to a female connector, or vice versa.

### 7.4 Punching/Crimping Tools

While preparing networking cables for creating computer networks such as LANs (Local Area Networks) one has to be very careful and precise. One has to use a variety of wire connector assembly and installation tools to assemble and install such connectors to each other. These tools include a variety of cable tie guns, crimpers, cutters, pliers, punch down tools, screwdrivers, splicers, strippers, and cable pulling grips. All these tools have their uses during the process of computer networking.

In this section, we will discuss punching and crimping tools.

#### 7.4.1 Punching Tools

These tools are loaded with a spring key. This spring key changes blades efficiently and has an incorporated on-off impact selector.

## Punch Down Tool

Notes

The punch tool is used to pop in the network cable in the patch panel or alike connection panels. For a tiny network up to 7 devices you might not want it as you can simply attach all of your devices directly into the switch.

Figure 7.12: Punch Down Tool



A punch down tool allows you to punch down twisted wires into a network connection. A punch down tool is useful to connect a bare wire to a connection either in a wiring panel, or to a connector in a Ethernet network.

It is a handheld tool with a slotted post which pushes a wire into a connector as you can see in the image on the right. There are different punchdown tools for different connection types. 66 blocks, 110 blocks, and krone blocks require different types of blades.

We use a punch down tool to terminate cable runs and cross connect jumpers at 66 pin, 110 pin blocks, and patch panels.

## 7.4.2 Crimping Tools

A crimping tool is a tool designed to crimp or connect a connector to the end of a cable.



*Example:* Network cables and phone cables are created using a crimping tool to connect the RJ-45 and RJ-11 connectors to the end of the cable.

The figure 7.13 is an example of what a crimping tool looks like. This example shows a tool capable of crimping both RJ-11 and RJ-45 connectors.

Figure 7.13: Crimping Tool



Source: <http://www.computerhope.com/jargon/c/crimp.htm>

A variety of crimping device tools and cable strippers are used to prepare the cable for installation. These tools are of different types. These are:

- **Cable Tie Tools:** These are used to tighten the ties around bundles of cables and wires. They use a tension control lever to provide precise tightening, while another lever cuts off the ties so that no loose ends are visible.

**Notes**

- **RJ-45 Crimp Tools:** These are used to crimp and cut the wires of an RJ-45 connector. These tools will also work on RJ-11 connectors as well. This tool consists of a built in cable stripper and a wire cutter. Thus, it cuts the wire in one go.
- **Hand Crimp Tools:** These are used where there are certain restrictions to using mechanized crimp tools, especially with regards to size, weight, and maneuverability. These tools can be either manual or powered. A hand crimp tool consists of a ratchet mechanism hand tool and a pair of jaws. These jaws are crimp dies. The cable can then be correctly crimped. These tools provide a means for correctly placing, supporting and holding a cable in place during the crimping process.
- **Compression Crimp Tools:** These are used to terminate a variety of wires, compression connectors, twisted pair modular plugs and jacks. These also have connector shut heights that are precisely engineered for specific connector requirements.

**Self Assessment**

Fill in the blanks:

8. The ..... tool is used to pop in the network cable in the patch panel or alike connection panels.
9. .... tools are used where there are certain restrictions to using mechanized crimp tools.

**7.5 Switches**

A concentrator is a device that provides a central connection point for cables from workstations, servers and peripherals. In a star topology, twisted-pair wire is run from each workstation to a central switch/hub. Most switches are active, i.e., they electrically amplify the signal as it moves from one device to another. Switches no longer broadcast network packets as hubs did in the past, they memorize addressing of computers and send the information to the correct location directly.

A network switch is a device that manages the sharing of multiple computers or networks on the same data connection. Another name for a network switch is a network bridge, which is a physical device responsible for routing and processing data within the open systems interconnection model. A network switch does not include hubs or repeaters, as these devices do not include any type of logical processors.

A network switch can support 10/100 Mbit/s (Megabits per second) or 10/100/1000 Mbit/s port transfer rates. It is possible to have multiple network switches operating at different speeds on the same network. However, this type of setup lends itself to bottlenecks and restricts the possible routes available for the flow of data.

A network switch is absolutely critical in the management of a computer network. The network switch functions as the traffic management system within the network, directing data packets to the correct destination. These devices are used to connect peripheral devices to the network and ensure maximum cost effectiveness and the ability to share resources. A typical setup of a network switch is two computers, one printer, and a wireless router.



**Caution** All the devices are connected to the network switch, and each item must be clearly identified and connection rules created.

Once the setup is done, any computer on the network, can use the same printer. All computers can transfer files to each other and anyone with a wireless card can access the network, print and transfer files. The network switch is designed to allow the resources to be shared without reducing performance.

A simple analogy for a network switch is a policeman at a four-way stop. The cars are the data packets that are sent from each device as it attempts to communicate with the other devices in the network. The policeman, or network switch, directs traffic, sending the data to the right location, without having any collisions.

### 7.5.1 Types of Switches

There are four main types of network switches. The four types are unmanaged switches, managed switches, smart switches, and enterprise managed switches. Each different types has its own strengths and weaknesses that need to be considered.

- An unmanaged switch is the cheapest option and is typically used in a small office or business. These network switches perform the basic functions of managing the data flow between a shared printer and multiple computers. They can either be desktop models or rack mounted.
- A managed switch has a user interface or software offering that allows users to modify the settings of the switch. There are multiple methods for updating the network switch, ranging from a serial console to an Internet based application. This type of network switch requires a knowledgeable user to adjust the settings as needed.
- A smart switch is the middle product offering between a unmanaged and managed switch. The user interface is web-based and set with the most popular default settings. Adjustments to one setting result in an automatic adjustment to the related setting.
- An enterprise-managed network switch has a wide range of adjustable settings to allow use within a large company or organization. These types of network switches are usually managed by network specialists and are constantly monitored, due to the size and complexity of the network.

### Self Assessment

Fill in the blanks:

10. A network ..... is a device that manages the sharing of multiple computers or networks on the same data connection.
11. A ..... is the middle product offering between a unmanaged and managed switch.

### 7.6 I/O Sockets

A socket is one of the most fundamental technologies of computer networking. Sockets allow applications to communicate using standard mechanisms built into network hardware and operating systems. Although network software may seem to be a relatively new “Web” phenomenon, socket technology actually has been employed for roughly two decades.

Software applications that rely on the Internet and other computer networks continue to grow in popularity. Many of today’s most popular software packages – including Web browsers, instant messaging applications and peer to peer file sharing systems – rely on sockets.

### 7.6.1 Point-to-Point Communication

In a nutshell, a socket represents a single connection between exactly two pieces of software. More than two pieces of software can communicate in client/server or distributed systems.



*Example:* Many Web browsers can simultaneously communicate with a single Web server.

However, multiple sockets are required to do this. Socket-based software usually runs on two separate computers on the network, but sockets can also be used to communicate locally (*interprocess*) on a single computer.

Sockets are *bidirectional*, meaning that either side of the connection is capable of both sending and receiving data. Sometimes the one application that initiates communication is termed the *client* and the other application the *server*, but this terminology leads to confusion in non-client/server systems and should generally be avoided.

### 7.6.2 Libraries

Programmers access sockets using code libraries packaged with the operating system. Several libraries that implement standard *application programming interfaces* (APIs) exist. The first mainstream package - the Berkeley Socket Library is still widely in use on UNIX® systems. Another very common API is the Windows Sockets (Winsock) library for Microsoft operating systems. Relative to other network programming technologies, socket APIs are quite mature: Winsock has been in use since 1993 and Berkeley sockets since 1982.

### 7.6.3 Interface Types

Socket interfaces can be divided into three categories. Perhaps the most commonly-used type, the stream socket, implements “connection-oriented” semantics. Essentially, a “stream” requires that the two communicating parties first establish a socket connection, after which any data passed through that connection will be guaranteed to arrive in the same order in which it was sent.

Datagram sockets offer “connection-less” semantics. With datagrams, connections are implicit rather than explicit as with streams. Either party simply sends datagrams as needed and waits for the other to respond; messages can be lost in transmission or received out of order, but it is the application’s responsibility and not the socket’s to deal with these problems. Implementing datagram sockets can give some applications a performance boost and additional flexibility compared to using stream sockets, justifying their use in some situations.

The third type of socket – the so-called raw socket – bypasses the library’s built-in support for standard protocols like TCP and UDP. Raw sockets are used for custom low-level protocol development.



*Task* Make distinction between different types of sockets.

### 7.6.4 Addresses and Ports

Today, sockets are typically used in conjunction with the Internet protocols – Internet Protocol, Transmission Control Protocol, and User Datagram Protocol (UDP). Libraries implementing

sockets for Internet Protocol use TCP for streams, UDP for datagrams, and IP itself for raw sockets.

To communicate over the Internet, IP socket libraries use the IP address to identify specific computers. Many parts of the Internet work with naming services, so that the users and socket programmers can work with computers by name (e.g., “thiscomputer.compnetworking.about.com”) instead of by address (e.g., 208.185.127.40). Stream and datagram sockets also use IP port numbers to distinguish multiple applications from each other.



*Example:* Web browsers on the Internet know to use port 80 as the default for socket communications with Web servers.

## Self Assessment

Fill in the blanks:

12. Sockets are ....., meaning that either side of the connection is capable of both sending and receiving data.
13. .... sockets offer “connection-less” semantics.

## 7.7 Creation of Cross Wires and Direct Cables

Cross over cable is the networking cable that connects two computers or network devices directly to one another. When purchasing this cable, the packaging must indicate that it’s a crossover cable for the required network interface; otherwise, it’s likely a typical straight through cable. Often, crossover cables are used to connect two computers with network cards together without using a network hub, network router, or network switch.

Direct or straight through cables is a network cable that connects a computer to a network device.



*Example:* Straight through cables connect a computer to a network hub, network switch, and network routers.

These are the standard network cables you would find at the store, unless labeled as a cross-over cable.

### 7.7.1 Requirements for Creating Cross Wires and Direct Cables

To create your own network cables you will first need the equipment we have listed below.

- **Cat5, Cat5e, Cat6, or Cat7 cable:** This cabling can be purchased in large spindles at stores that specialize in cabling. Cat5 cabling is the most commonly used cable used today for networks
- **RJ-45 connectors:** These connectors can be purchased at most electronic stores and computer stores and usually come in bulk packages. It’s always a good idea to get more than you expect you will need.
- **Crimping tool:** These tools are often purchased at electronic stores such as radio shack. To create a network cable you will need a crimper that is capable of crimping a RJ-45 cable (not just a RJ-11 cable, which looks similar to a RJ-45).

Notes

- **Wire stripper or Knife:** If you plan on making several network cables you should also consider getting a wire stripper cable of stripping Cat5, Cat6, or your cable of choice. If you do not plan on creating many network cables a knife will suffice. For simplicity and to prevent potential issues we recommend a wire stripper.

### 7.7.2 Creating Cross over Cable

The steps for creating a cross over cable are discussed below:

1. Start by threading some shields onto the cable.

Figure 7.14: Threading Shields

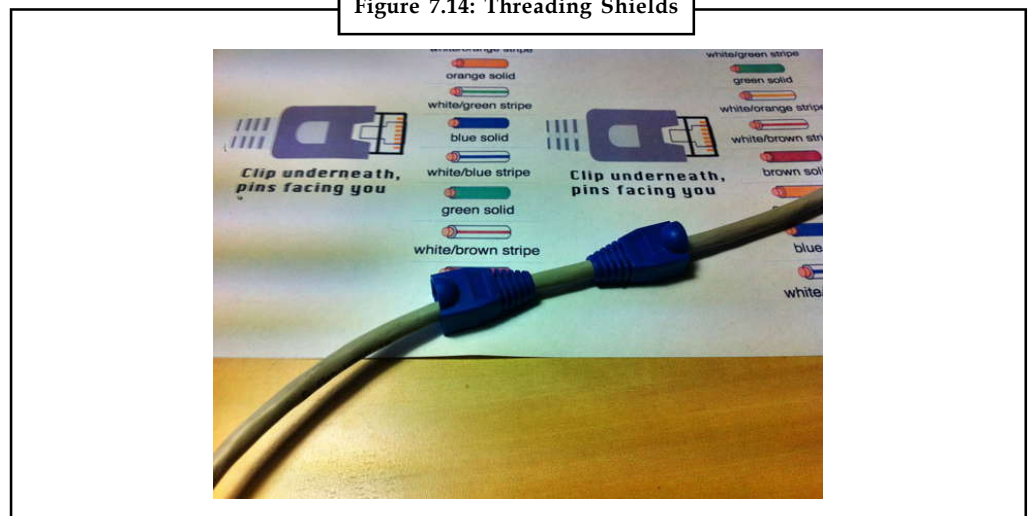

Source: <http://www.makeuseof.com/tag/ethernet-crossover-cable/>

2. Strip about 1.5cm of cable shielding from both ends - your crimping tool should have a round area specifically for this task.

Figure 7.15: Stripping Cable Shielding

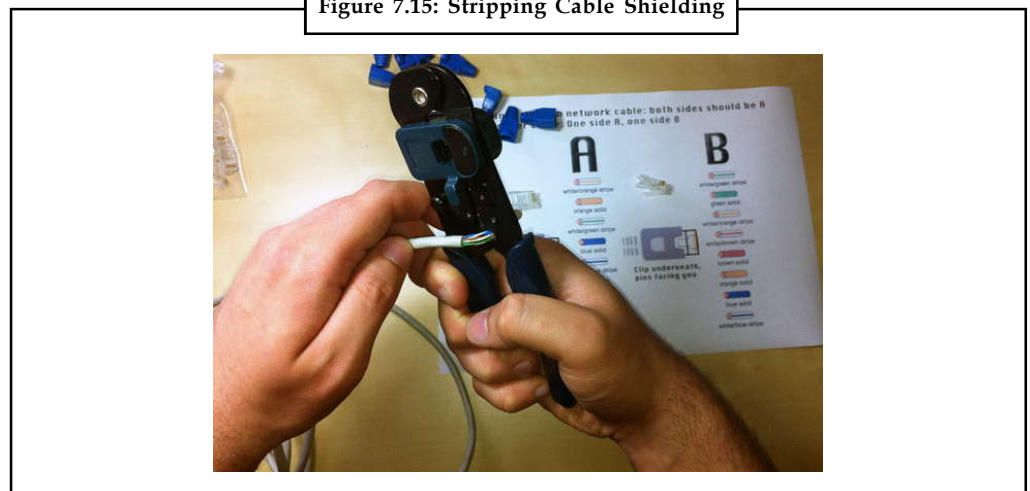

Source: <http://www.makeuseof.com/tag/ethernet-crossover-cable/>

3. Untangle the wires (there should be 4 "twisted pairs"). Arrange them in the order shown on the sheet from top to bottom; one end should be in arrangement A, the other B.



Figure 7.16: Untangling the Wires

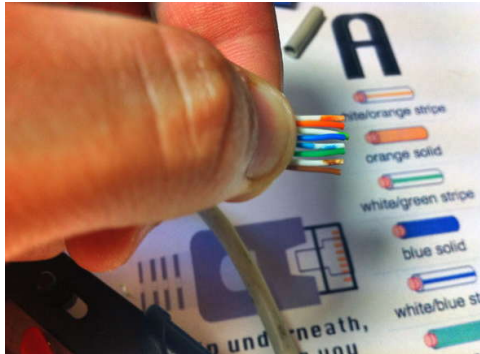

Source: <http://www.makeuseof.com/tag/ethernet-crossover-cable/>

4. When you've got the order correct, bunch them together in a line. If you have some that stick up beyond the others, use the crimping tool to crop them back to a uniform level.

The hardest part is placing these into the RJ45 plug without messing up the order. Hold the plug with the clip side facing **away** from you; the gold pins should be facing **towards** you.

Figure 7.17: Bunching the wires together in lines

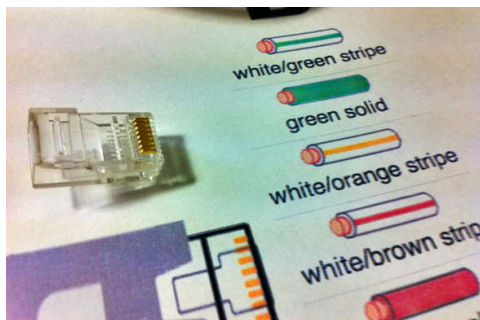

Source: <http://www.makeuseof.com/tag/ethernet-crossover-cable/>

5. Push the cable right in – the notch at the end of the plug should be over the cable shielding. If it isn't, you stripped too much shielding off, so consider cropping the cables back a little more.

Figure 7.18: Pushing the Cable

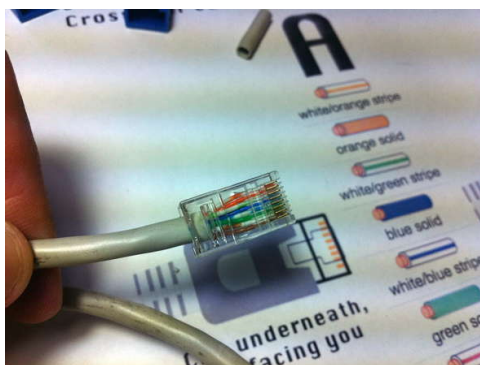

Source: <http://www.makeuseof.com/tag/ethernet-crossover-cable/>

Notes

6. When the wires are sitting tightly in the plug, insert in into the end of your crimping tool and push down - in theory the crimper is shaped to the exact right size, but in practice we find pushing too hard can crack the brittle plastic plug.
7. Repeat for the other end, using diagram B instead.
8. If you don't have a cable tester, the easiest way to test is just to plug it in.

### 7.7.3 Creating a Direct or Straight through cable

The steps for creating a straight through cable are discussed below:

1. Cut a piece of cable to the length you will need. Give a little extra to make room for mistakes.
2. Strip a half inch to an inch of the outer jacket away from the cable. If you use strippers make sure not to nick the wire pairs and expose the copper, this could introduce crosstalk onto your wires. It is preferred to use a scissor and fingers to tear away the jacket. Then we cut with the scissors to clean up the edge.

Figure 7.19: Stripping a half inch to an inch of the outer jacket away from the cable

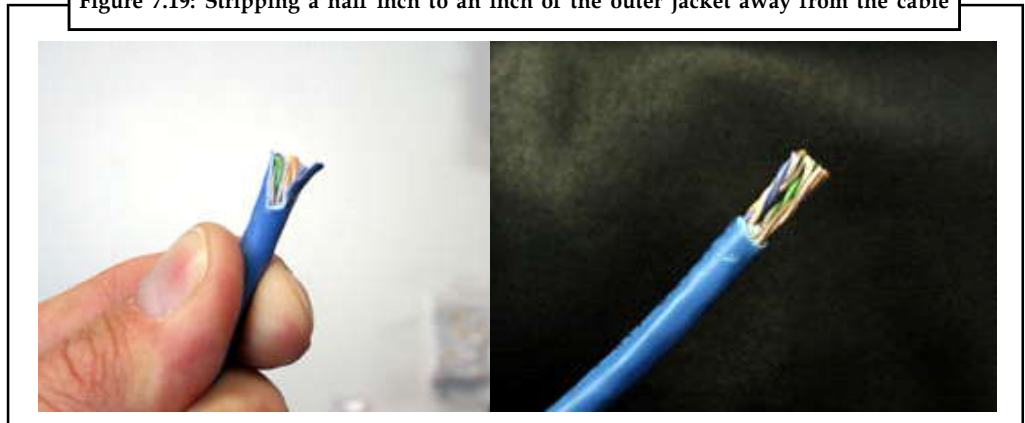

Source: <http://www.danscourses.com/CCNA-1/how-to-make-a-straight-through-ethernet-cable.html>

3. Now you need to untwist the wire pairs (not too much, only undo one or two twists) so you can align them according to the EIA-TIA568B wire color sequence. We can use our fingers to straighten the wires by bending them back and forth, straightening them as they warm up.

Figure 7.20: Untwist the Wire Pairs

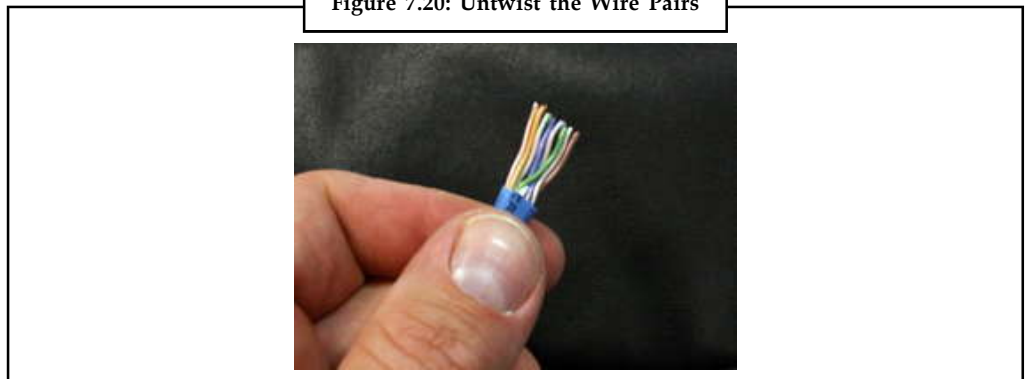

Source: <http://www.danscourses.com/CCNA-1/how-to-make-a-straight-through-ethernet-cable.html>  
EIA-TIA 568B Standard

4. We usually have to trim the ends of the wires so they line up and create a straight edge.

Notes

Figure 7.21: Trimming the Ends

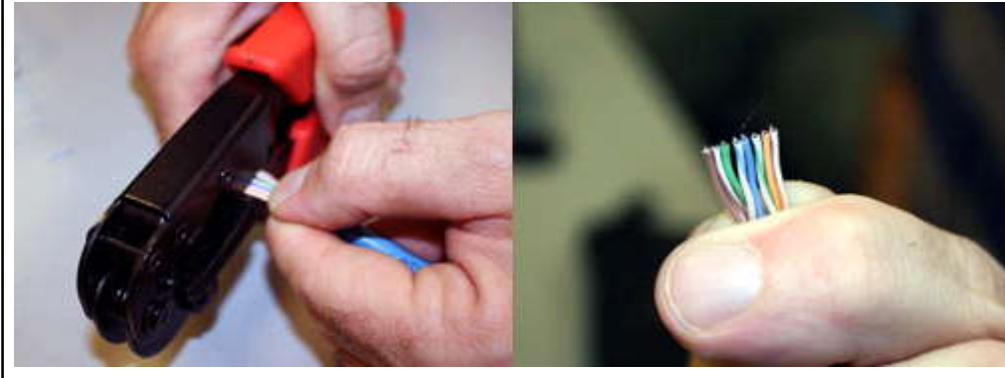

Source: <http://www.danscourses.com/CCNA-1/how-to-make-a-straight-through-ethernet-cable.html>

5. Now holding an RJ-45 connector with the tab side facing down, push the 8 wires into the connector, sliding each wire into a groove. While holding the connector tab side down the white/orange wire should be on the far left and the brown wire should be on the far right.



*Notes* It is very important that the wires push all the way up and into the connector so that when the pins are pushed down during crimping they will make contact with the wires. The sleeve or jacket of the cable (light blue below) should also be pushed in as far as it can go so it will be held in place once crimped. You may want to pull the wires out and put them back in to make sure they are sliding in correctly, this will also further straighten the wires.

6. Notice the tab make sure it is facing down push the wires and sleeve into the connector

Figure 7.22: Pushing the wires into the connector



Source: <http://www.danscourses.com/CCNA-1/how-to-make-a-straight-through-ethernet-cable.html>

7. Before crimping, examine the cable and connector from the side. Did the wires slide all the way up in to the proper grooves? Are the colors in the proper order when observed from tab side down? Did the jacket slide all the way into the connector? If not, you may need pull the cable out of the connector, trim the wires or the jacket accordingly and reinsert.

Notes

Figure 7.23: Examining the Cable and Connector

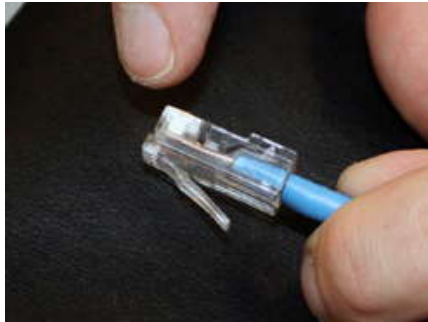

Source: <http://www.danscourses.com/CCNA-1/how-to-make-a-straight-through-ethernet-cable.html>

8. If everything looks good, using your crimper tool insert the connector and cable into the 8 wire slot and press down tightly. This will cause a piece of plastic in the connector to press down on the jacket and hold the cable in the connector preventing it from accidentally pulling out. Crimping also forces copper pins in the connector to push down and make contact with the separate wires.

Figure 7.24: Inserting the connector and cable into the 8 wire slot



Source: <http://www.danscourses.com/CCNA-1/how-to-make-a-straight-through-ethernet-cable.html>

9. You are now finished terminating one end of the cable. Repeat the process on the other end of the cable and when you are done, insert the cable into a cable tester and run a wire test to make sure that none of the wires are accidentally crossed, by not being in the right order, or open by not touching the connector pins. Depending on the cable tester you may need to read the manual to understand the device output.

Figure 7.25: Terminating one end of the cable completed



Source: <http://www.danscourses.com/CCNA-1/how-to-make-a-straight-through-ethernet-cable.html>

10. Lastly, test your cable by using it on your network. Attach the cable to your computer's NIC and the other end to your switch. Do you see green lights? Open the Network Connections dialogue box in Windows, does it show a properly enabled and active connection on the NIC. You can also look for the status in your system tray network connections icon. If you have an internet connection, can you browse the web? If not can you ping your gateway from a command prompt?

## Self Assessment

Fill in the blanks:

14. .... cable is the networking cable that connects two computers or network devices directly to one another.
15. .... cables is a network cable that connects a computer to a network device.

## 7.8 Summary

- UTP as depicted is the copper media, inherited from telephony, which is being used for increasingly higher data rates, and is rapidly becoming the de facto standard for horizontal wiring.
- Shielded Twisted Pair (STP) differs from UTP in that a metallic shield or screen surrounds the pairs, which may or may not be twisted.
- Coaxial cable is the kind of copper cable used by cable TV companies between the community antenna and user homes and businesses.
- Optical fiber carries the transmitted information in the form of a fluctuating beam of light in a glass fiber rather than as an electrical signal on a wire.
- Hubs are straightforward network devices, and their straightforwardness is reflected in their low cost.
- Connector is a simple device that physically links, couples, or connects, two things together.
- A network switch is a device that manages the sharing of multiple computers or networks on the same data connection.
- Sockets allow applications to communicate using standard mechanisms built into network hardware and operating systems.
- The punch tool is used to pop in the network cable in the patch panel or alike connection panels.
- A crimping tool is a tool designed to crimp or connect a connector to the end of a cable.

## 7.9 Keywords

**Coaxial cable:** Coaxial cable is the kind of copper cable used by cable TV companies between the community antenna and user homes and businesses.

**Connector:** Connector is a simple device that physically links, couples, or connects, two things together.

**Crimping tool:** A crimping tool is a tool designed to crimp or connect a connector to the end of a cable.

**Notes**

**Hubs:** Hubs are straightforward network devices, and their straightforwardness is reflected in their low cost.

**Punch tool:** The punch tool is used to pop in the network cable in the patch panel or alike connection panels.

**Sockets:** Sockets allow applications to communicate using standard mechanisms built into network hardware and operating systems.

**Switch:** A network switch is a device that manages the sharing of multiple computers or networks on the same data connection.

**Twisted pair:** A twisted pair is a pair of copper wires, with diameters of 0.4-0.8 mm, twisted together and wrapped with a plastic coating.

**7.10 Review Questions**

1. What are the different types of twisted pair cable? Explain.
2. Explain the concept of optical fiber cable with example.
3. Make distinction between “step-index” and “Graded Index” Multimode Fiber.
4. What is a networking hub? Discuss the different types of hubs.
5. Illustrate the working of hubs.
6. Differentiate between male connector and female connector.
7. Describe various punching and crimping tools.
8. Explain the types of network switches.
9. A socket represents a single connection between exactly two pieces of software. Comment.
10. Illustrate the steps used in creating cross over cables.

**Answers: Self Assessment**

- |                                |                   |
|--------------------------------|-------------------|
| 1. Gauge                       | 2. Thinnet        |
| 3. graded index                | 4. Hub            |
| 5. multi port repeater         | 6. Connector      |
| 7. gender changer              | 8. Punch          |
| 9. Hand Crimp                  | 10. Switch        |
| 11. smart switch               | 12. Bidirectional |
| 13. Datagram                   | 14. Cross         |
| 15. Direct or straight through |                   |

**7.11 Further Readings**



Books

Barrett, Diane. & King, Todd (2005). “Computer networking illuminated.” Jones & Bartlett Learning.

Blundell, Barry (2008). *“Computer hardware.”* Cengage Learning EMEA.

Notes

Englander, Irv (2003). *“The architecture of computer hardware and systems software: An Information Technology Approach.”* Wiley.

Sarkar, Nurul (2006). *“Tools for Teaching Computer Networking And Hardware Concepts.”* Information Science Pub.

Shinder, Bebra Littlejohn (2001). *“Computer Networking Essentials.”* Cisco Press.



Online links

<http://blog.creativeitp.com/posts-and-articles/networking/hubs-switches-routers-and-bridges/>

<http://www.darron.net/network/secondpage.html>

<http://www.mof.gov.bt/publication/files/pub9ew3702mv.pdf>

[http://www.sis.pitt.edu/~icucart/networking\\_basics/kinds\\_of\\_cables.html](http://www.sis.pitt.edu/~icucart/networking_basics/kinds_of_cables.html)

## Unit 8: IP & Setting up a Computer on LAN

### CONTENTS

Objectives

Introduction

8.1 IP Protocols

8.1.1 IP Addresses

8.1.2 IPv4 Addressing

8.1.3 Dotted Decimal Notation

8.1.4 Classification of IPv4 Addresses

8.1.5 Subnetting for IP Addresses

8.2 Setting up a Computer on LAN

8.3 Summary

8.4 Keywords

8.5 Review Questions

8.6 Further Readings

### Objectives

After studying this unit, you will be able to:

- Explain the concept of IP Protocols
- Discuss the Subnetting for IP Addresses
- Explain the setting up a computer on LAN

### Introduction

Internet Protocol is part of the Internet suite of communications protocols that provides globally unique addresses in dotted quad notation, transmits data in packets and performs routing between IP based networks. An IP address is composed of four octets (numbers in the range of 0 to 255) separated by decimal points. The IP address is used to uniquely identify a host or computer on the LAN. In this unit, we will discuss the concept of Internet Protocol (IP). Also we will discuss setting up a computer on a LAN.

### 8.1 IP Protocols

IP stands for Internet Protocol. It was developed with the objective to specify a suite of protocols capable of providing transparent communications interoperability services between computers of all sizes, regardless of the hardware or operating system platforms supporting them. Over the years, IP has become the most widespread of today's protocols. One reason for IP's popularity is the public availability of its protocols' specifications. In this sense, IP can justifiably be considered an open system. Most users rely on IP for the purpose of file transfers, electronic mail (e-mail), and remote login services.



It is a connectionless type service and operates at third layer of OSI reference model. That is, prior to transmission of data, no logical connection is needed. This type of protocol is suitable for the sporadic transmission of data to a number of destinations. It does not have such functions as sequence control, error recovery and control, flow control but it identifies the connection with port number. The IP datagram has a header of 20-byte fixed size and a text of variable length optional parts. The header format of IP datagram is depicted in Figure 8.1. The header format is transmitted from left to right, with the high order bit of Version field is transmitted first.

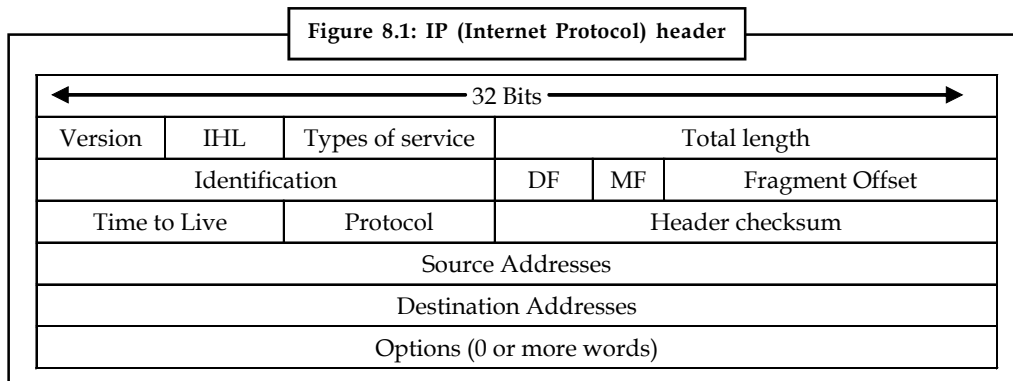

Data encapsulation adds the IP header to the data. The IP header consists of five or six 32-bit words; the sixth word is attributed to the IP options field. The different fields of the IP header are given as below:

- Version refers to the version of the IP protocol in use and keeps track of the version of the protocol to which the datagram belongs to. The current version of IP is 4.
- Internet Header Length (IHL) indicates the length of the header field in 32-bit words. The minimum value of the header field is 5 that apply when no option is present. The maximum value of this 4 bit field is 15 that restricts the header to 60 bytes and thus Option field to 40 byte.
- Type of service enables the host to indicate the subnet what kind of service (e.g., reliability and speed) it wants. It refers to any of the type of services that IP supports. Desired service type is normally specified by user level applications. **Examples** of service type include minimum and maximum throughput, requested by applications such as the File Transfer Protocol (FTP) and Simple Mail Transfer Protocol (SMTP).
- Total length has everything in the datagram (max. 64 KB). If it is subtracted from the IHL field, it indicates to IP the actual length of the data field.
- Identification enables the destination host to determine which datagram a newly arrived fragment belongs to.
- DF means Do not Fragment.
- MF is for More Fragments.
- Fragment offset indicates the source location of the current datagram. The elementary fragment unit size is 8 bytes.
- Time to live that counts hops is expressed in seconds. A zero count indicates that the packet is discarded. TTL is employed by IP to prevent a lost datagram from endlessly looping around the network. IP achieves this objective by initializing the TTL field to the maximum number of routers that the packet can traverse on the network. Every time the datagram traverses a router, IP decrements the TTL field by 1.

Notes

- Protocol indicates the destination which transports process to give the datagram to (TCP, UDP, or others).
- Header checksum verifies the header only. The algorithm is to add up all the 16-bit half words as they arrive, using one's complement arithmetic.
- Source/Destination address tells the network number and host number.



*Notes* Options provides an escape to allow subsequent versions of the protocol to have information not present in the original design, to allow experimenters to try out new ideas, and to avoid allocating header bits to information that is rarely needed. On its presence, it includes optional control information.



*Example:* The route record, which includes a record of every router that the datagram traversed during its trip around the network.

### 8.1.1 IP Addresses

Using Internet has become common. We will now understand how Internet interprets the Internet address. WWW is the name of the server owned by the institution (in this case, it is hotmail) and this server is connected to the Internet to a domain server namely (com in this case) which maintains a database of the addresses of different servers using the same domain com. The domain name has no geographical relevance and two sites with same domain name may exist at two end of this world.



*Example:* The Internet addresses are written as www.hotmail.com we write one more address as server.institution.domain. The address www.hotmail.com is not actual address; it is a text version of the Internet address, which is basically a binary representation. Now we compare www.hotmail.com, and server.institution.domain.

The above case is the simplest case. In another instance an organization may be large enough and have several other servers for different purposes such as web server, email server, print server etc.



*Example:* Suppose we now take an example www.sun.planet.universe.in. This address has five parts separated by three dots. If we try to understand this address, this address will indicate that a group Planets (planet) comes under a Universe sub domain which is a part of India domain and maintaining one server sun out of many servers, which is linked to Internet through its web server. Likewise any organization with several departments may create addresses for its sub domain with different servers being maintained there.

Internet is the collection of several independent networks, which are interconnected with one another. Now each independent network may have several hosts. Keeping this in mind, you can now think of address of your house. Your house has a unique house number, which is not assigned, to any other house in your locality. In this case, your house can be considered as a host. Your locality can be considered as network and your city as domain. You can write your address in Internet addressing notation as houseno.locality.city. If suppose you want to tell your address to a foreigner, then you will have to add your country name in your address. In this case it will become houseno.locality.city.country. Now if anybody desires to send you a letter or visit your house, he will first has to come to your country and then to your city. After that he will reach to

your locality and then your house by your house number. The same analogy applies in case of Internet addressing.

A host on Internet has two parts. These are identification of the network and identification of the host on the network. In this manner, the address of a host is therefore comprised of two parts namely network address and host address. These two parts together make 32 bit long IP address for a particular host on the Internet.



*Did u know?* The IP address is written in four octets each separated by a dot. It may have a form like 197.23.207.10. Presently, we are using IP address version 4 (IPv4). However, IP address version 6 (IPv6) is gradually under implementation stage.

### 8.1.2 IPv4 Addressing

IPv4 addresses are uniquely used as identifiers, which work at network layer to identify the source or destination of IP packets. Presently, the version of IP, which is in use, is called as IPv4. In this version, every node on Internet may have one or more interfaces, and we are required to identify each of these devices with a unique address assigned to each of them. It means that each node is assigned one or more IP addresses to invoke TCP/IP. These are logical addresses and have 32 bits.

Technically, IP addresses are expressed using binary notation with 32 bit long string. In order to make these strings to remember easily, dotted decimal notations are used, in which periods or dots separate four decimal numbers from 0 to 255 representing 32 bits. As there are 32 bits therefore each decimal number contains 8 bits and called octet.



*Example:* The IPv4 address 11000000101010000000101000011001 is expressed as 192.168.10.25 in dotted decimal notation. Below are the steps to convert an IPv4 address from binary notation to dotted decimal notation:

Break 32 bit long address into segments of 8-bit blocks: 11000000 10101000 00001010 00011001

Write decimal equivalent of each segment: 192 168 10 25

Separate the blocks with periods: 192.168.10.25

Figure 8.2 shows the IP address structure.

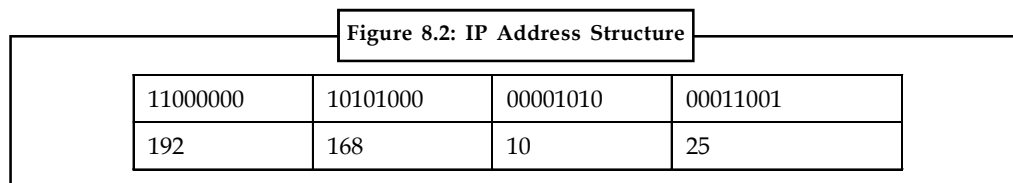

### 8.1.3 Dotted Decimal Notation

We have seen that IPv4 address is expressed as a 32-bit number in dotted decimal notation. IP addresses may have fixed part and variable part depending upon the allocation of total addresses to you or your organization. Fixed part of the address may be from one octet to three octets and remaining octets will then be available for variable part. An IPv4 address is assigned using these parts. All bits in the fixed octet (s) are set to 1 while variable octet(s) are set to 0 bits. Thereafter, convert the result into dotted decimal notation.

Notes



*Example:* You may take an IP address as 192.168.10.25. Now set all fixed bits to 1 and set all variable bits to 0. This gives 11111111 11111111 00000000 00000000. On converting it in dotted decimal notation, the result is 255.255.0.0. This dotted decimal notation with fixed and variable parts is used as address prefix to 192.168.10.25 and is expressed as 192.168.10.25, 255.255.0.0. This way of expressing the prefix length as a dotted decimal number is known as network mask or subnet mask notation.



*Task* Illustrate with example how to convert an IPv4 address from binary notation to dotted decimal notation.

### 8.1.4 Classification of IPv4 Addresses

Internet standards allow the following addresses:

- **Unicast:** It is assigned to a single network interface located on a specific subnet and facilitates one-to-one communication. This is unique address globally for the identification of a device on the network. It may be understood as the house number on a particular locality. It includes a subnet prefix and a host ID portion.
- **Subnet prefix:** The subnet prefix is basically network identifier or network address portion of an IP unicast address. It should be noted that all nodes on the same physical or logical subnet must use the same subnet prefix, which eventually becomes unique within the entire TCP/IP network.
- **Host ID:** The host ID, which is a host address portion of an IP unicast address, identifies a network node to which some devices are interfaced. It is also unique within the network segment.
- **Multicast:** It is used for one or more network interfaces located on various subnets. It allows one-to-many communication. It delivers single packets from one source to many destinations. These addresses are part of Class D addressing scheme.
- **Broadcast:** It is allocated to all network interfaces located on a subnet and is used for one-to-everyone on a subnet communication. It delivers packets from one source to all interfaces on the subnet. Broadcast addresses may be further classified as network broadcast, subnet broadcast, all subnets directed broadcast and limited broadcast.



*Notes* Internet Addresses are further classified into different classes. It is based on the number bits are used for the address prefix of a single subnet and the number of bits are used for the host ID. It therefore allocates the number of networks and the number of hosts per network.

There are five address classes as given below:

- **Class A:** It uses an 8 bit network number whose first bit is always zero as shown in Table 1. It is reserved for IP unicast addresses. If the number of hosts is very large on a network, this class is used. It uses the only one octet to define prefix length. The numbers of network, which can be accommodated, are 28 or 128. However, out of these 128 addresses, 2 are used for administrative purposes and thus 126 addresses are available as prefix length. The remaining 3 octets are used for identifying up to 224 or 16,777,214 host IDs.

- **Class B:** It uses 16 bits for both the network address and host address. In this case the first two bits are always 10. It is reserved for IP unicast addresses. It uses 2 octets for a particular network while remaining two octets for host IDs. They are particularly used for medium to large-sized networks. The Class B addresses can be provided to 16,384 networks with up to 65,534 hosts per network.
- **Class C:** It is reserved for IP unicast addresses. They are meant for small networks. The first 3 octets specify a particular network and the last one octet specify host IDs. The Class C addresses may be used up to 2,097,152 networks with up to 254 hosts per network. Its first three bits are always set to 110.
- **Class D:** It defines IP multicast addresses.
- **Class E:** These addresses were reserved for experimental uses.

The Table 8.1 represents IPv4 addresses classifications.

Table 8.1: Classifications of IPv4 addresses

32 bit address					Number of possible networks	Maximum number of host or nodes
Classification	Octet 1	Octet 2	Octet 3	Octet 4		
Class A	0bbbbbbb	xxxxxxxx	xxxxxxxx	xxxxxxxx	$2^7 = 128$	$2^{24} = 16,777,216$
Class B	10bbbbbb	bbbbbbbb	xxxxxxxx	xxxxxxxx	$2^{14} = 16,384$	$2^{16} = 65,536$
Class C	110bbbb	bbbbbbbb	bbbbbbbb	xxxxxxxx	$2^{21} = 2,097,152$	$2^8 = 256$
Class D	1110bbbb followed by a 28 bit multicast address					
Class E	1111; reserved					

Allocation of the IPv4 address based on the above schemes sometimes proves to be wastage of addresses. Any organization with Class A address may have 16,777,214 hosts. Probably, no organization may have more than 100,000 hosts. In this case a huge IPv4 addresses are just wasted. Earlier, Classless Inter-Domain Routing (CIDR) method was used to allocate IPv4 addresses based on the organization's needs. The agency namely Internet Corporation for Assigned Names and Numbers (ICANN) or an Internet service provider (ISP) are responsible to determine the need of an organization for allocating IPv4 addresses under required Class.



**Caution** In case of individual address, public address is used. Private addresses are also allocated based on proxied or translated connectivity to the Internet.

It is observed that a user who is either a part of any organization or belong to an ISP did not require direct connectivity to the Internet. Therefore such organizations or ISPs require only a few public addresses for their nodes such as proxy servers, routers, firewalls, and translators etc. to connect directly with the Internet. Therefore, some the addresses are reserved for private use distinctly from public addresses.

Address is an identifier that is assigned to a device attached to a node in the Internet. It tells about the source or destination of IP packets. Addresses are classified based on their purposes as unicast, multicast and broadcast. The number of network segments and hosts on the network is determined based on Class A, B and C addresses for unicast communication.

Notes



*Task* Compare and contrast multicast and broadcast.

### 8.1.5 Subnetting for IP Addresses

Over the past several years, the Internet has scaled enormous volume in terms of hosts connected to it and therefore IPv4 addresses yet available are becoming scarce. You may have confusion here that 32 bits give  $2^{32}$  unique addresses which comes around 4.3 billion different addresses. But this is not the condition because of the different classes of the IPv4 addresses. Suppose a medium sized organization gets Class B address based on its current user population of say 1000. It uses 1000 different addresses. But the organization management has the ability to assign  $2^{16} = 65,536$  different identifiers. It means that there is 64,536 addresses wastage. Since they all belong to the same class B network number, they cannot be reclaimed by any other organization. A network administrator may suggest using Class C network address, which may require at least four class C networks. Later on, suppose, the number of users increase and the organization applies for another class C network, it might not get the same or if it gets, it has to pass through a hell of paper works and delays. In addition there is another angle of this problem with regard to additional routing. With many Class C networks, you need to have more network number for routers to track. Consequently performance of the network deteriorates. The solution of these problems lie either in increasing the number of bits in IP address or classless inter domain routing (CIDR).

We may also use a technique called subnetting to efficiently divide the address space allocated to an organization to the different users divided among different subnets of an organization network. Therefore subnetting is a process through which the address space of a unicast address prefix is efficiently divided for allocation among the subnets of an organization network. As we know that a unicast address have fixed and variable portions. The fixed portion of a unicast address prefix has a defined value. The variable portion of a unicast address prefix has the bits beyond the prefix length, which needs to set to 0.



*Did u know?* Subnetting uses the variable portion of a unicast address prefix for assignment to the subnets of an organization network.

In order to implement subnetting, you need to follow the some guidelines:

- Assess the number of subnets requirement.
- Assess the number of host IDs for each subnet.
- After this, a set of subnetted address prefixes with a range of valid IP addresses may be defined.

Following steps are followed for Subnetting:

- Estimate the number host bits for the subnetting.
- Determine the new subnetted address prefixes.
- Determine the range of IP addresses for each new subnetted address prefix.

We may now learn as to how the subnet prefix of an IP address is determined. Following steps give you a way to determine the same without the use of binary numbers:

Write the number  $n$  (the prefix length) as the sum of 4 numbers by successively subtracting 8 from  $n$ .



Example: 22 is  $8+8+6+0$ .

In a table with four columns and three rows, place the decimal octets of the IP address in the first row. The second row will then contain the four digits of the sum as has been determined in step 1.

The columns having 8 in the second row, write the corresponding octet from the first row to the third row. In case of 0 in a column in the second row, place 0 in the third row.

The column in the second row having a number between 0 and 8, convert the decimal number in the first row to binary. Now select the high-order bits for the number of bits indicated in the second row and put zero for the remaining bit and then convert back to decimal number. This will be the entry in that column.

For our example the entry in third column of first row is 10. Therefore the binary equivalent is 00001010. Again the third column of second row is having 6. It means we have to take 6 bits as such from high bi side and converting the remaining two bits as 00. This will give us a binary number as 00001000 which is decimal equivalent to 8. Therefore, the entry 8 will go in that column.

192	168	10	25
8	8	6	0
192	168	8	0

This gives the subnet prefix for the IPv4 address configuration 192.168.10.25/22 as 192.168.204.0/22.

Now, we have to extract the subnet prefix from an arbitrary IPv4 address using an arbitrary subnet mask. For this purpose a mathematical operation logical AND is used. A logical comparison between the 32-bit IP address and the 32-bit subnet mask is performed. It gives the subnet prefix. For example, we may consider the following possible addresses for Class C.

Class C Network	Bit Representation	Address Range
210.195.8.0	11010010-11000011-00001000-xxxxxxx	210.195.8.0-211.195.8.255
210.195.9.0	11010010-11000011-00001001-xxxxxxx	210.195.9.0-211.195.9.255
210.195.10.0	11010010-11000011-00001010-xxxxxxx	210.195.10.0-211.195.10.255
210.195.11.0	11010010-11000011-00001011-xxxxxxx	210.195.11.0-211.195.11.255

These Class C networks define the contiguous set of addresses from 210.195.8.0 to 210.195.11.255. On examining these addresses, it is observed that the first 22 bits are same for each address. It means that any of these Class C networks has 22 bit network number followed by a 10 bit local identifier for hosts. A router then can extract the network number using a logical AND operation between a 22-bit subnet mask and an IP address.

For this example, we can say that a router can represent the four networks using the single entry 210.195.8.0/22, where /22 indicates the network number is 22 bits long. Likewise, 210.195.8.0/20 address would first 20 bits and so on. This indicates that we are grouping different smaller networks together and they are being treated same for the routing purposes.

Notes



Example: Our IPv4 address is 210.195.8.0 and a 22 bit subnet mask is 255.255.252.0.

11010010 – 11000011 – 000010xx – xxxxxxxx (IP Address)

AND

11111111 – 11111111 – 11111100 – 00000000 (22 bit subnet mask)

11010010 – 11010011 – 00001000 – 00000000 (network number)

(210) (195) (8) (0)

The result of the bit-wise logical AND of the 32 bits of the IPv4 address and the subnet mask is the subnet prefix 210.195.8.0. It may therefore be noted that the bits in the fixed portion of the address (in which the bits in the subnet mask are set to 1), the subnet prefix bits are copied from the IPv4 address, essentially extracting the subnet prefix of the IPv4 address. On the other side the bits in the variable portion of the address where these are set to zero, the subnet prefix bits are also set to 0 and thus discarding the host ID portion of the IPv4 address.

**Self Assessment**

Fill in the blanks:

1. .... is a connectionless type service and operates at third layer of OSI reference model.
2. .... adds the IP header to the data.
3. .... indicates the source location of the current datagram.
4. .... refers to the version of the IP protocol in use and keeps track of the version of the protocol to which the datagram belongs to.
5. .... indicates the length of the header field in 32-bit words.
6. .... addresses are uniquely used as identifiers, which work at network layer to identify the source or destination of IP packets.
7. IP addresses are expressed using ..... notation with 32 bit long string.
8. The ..... is basically network identifier or network address portion of an IP unicast address.
9. .... is used for one or more network interfaces located on various subnets.
10. The ..... identifies a network node to which some devices are interfaced.
11. .... is an identifier that is assigned to a device attached to a node in the Internet.
12. .... is a process through which the address space of a unicast address prefix is efficiently divided for allocation among the subnets of an organization network.

**8.2 Setting up a Computer on LAN**

In this section we will discuss setting up a computer on LAN in windows 7.

Windows 7 is the newer version of windows and contains remarkable effect on every sector of operation. It works very smoothly. Now peoples are converting from Window Xp to Windows



7 or Vista to Windows 7. That's why they need to setup all the features they used in their older version of operating system. From this features Local Area Connection is one important setup.

LAN (Local Area Network) card will automatically install when you setup windows 7. LAN connection is required when you want to share your pc with others in your HomeGroup. Supposes you have two Laptop/Pc and you want to connect them for some purpose say playing multiplayer games (Cod 1,Cod 2,Cod4,Cod5 etc) or to access another Pc ,just setup Local Area Connection. You can also connect your Pc to your friends Pc no meter how far the distance, connect them with cable connection.

The steps for setting up a Local Area Connection are given below:

1. **Create WorkGroup:**

- ❖ Go to my computer properties.
- ❖ Click change settings.

**Figure 8.3: Clicking Change Settings**

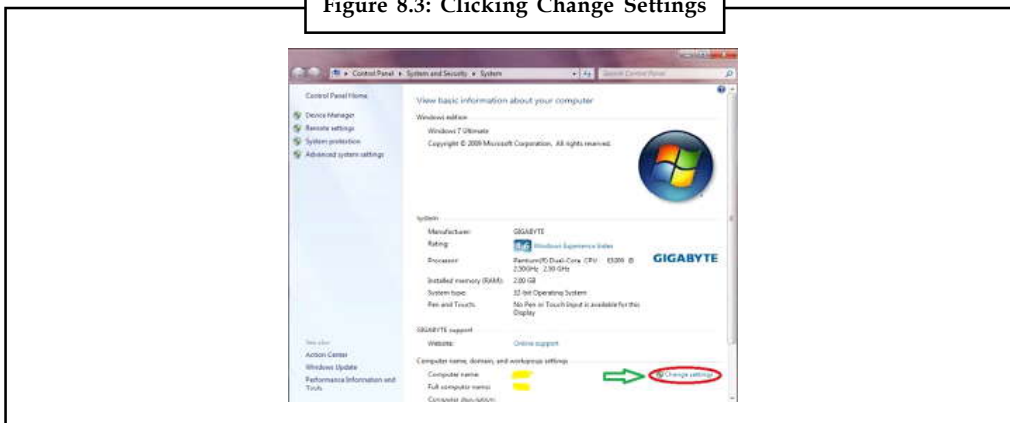

Source: <http://xclusive4all.blogspot.in/2009/10/how-to-setup-local-area-connection-in.html>

- ❖ This will show the window given below:

**Figure 8.4: System Properties Window**

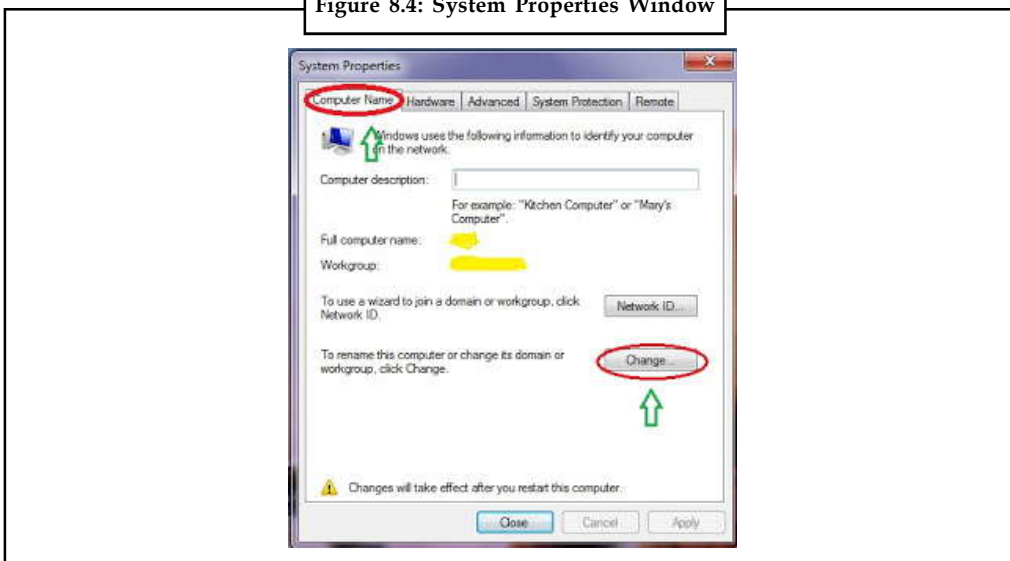

Source: <http://xclusive4all.blogspot.in/2009/10/how-to-setup-local-area-connection-in.html>

Notes

- ❖ Type your Computer name and WorkGroup

Figure 8.5: Typing Computer name and workgroup

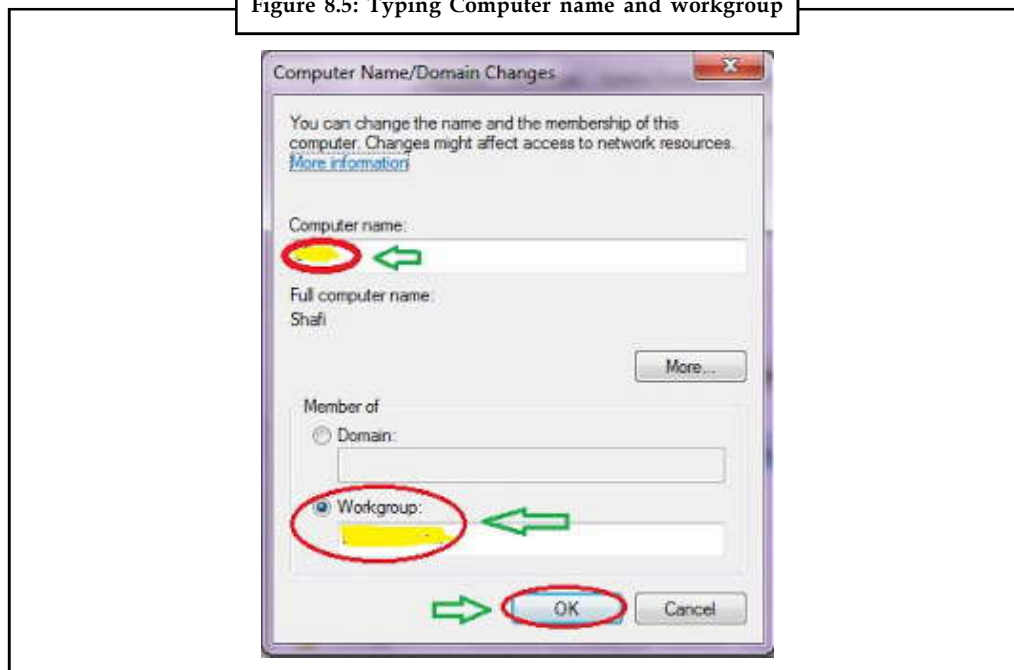

Source: <http://xclusive4all.blogspot.in/2009/10/how-to-setup-local-area-connection-in.html>

- ❖ This message will appear as shown in figure 8.6.

Figure 8.6: Click OK to restart Your Computer

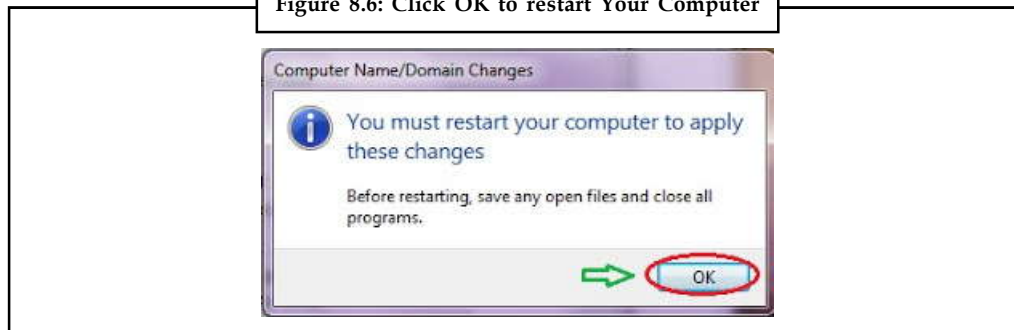

Source: <http://xclusive4all.blogspot.in/2009/10/how-to-setup-local-area-connection-in.html>

- ❖ Restart your computer then your WorkGroup will be created.

2. Assigning IP Address:

- ❖ Go to control panel
- ❖ Click Network And Internet
- ❖ Click Network And Sharing Center
- ❖ Click HomeGroup
- ❖ Click Advance Sharing Setting
- ❖ There are two types: Home to work, Public

- ❖ From Home to work select >Turn on Network Discovery >Turn on file and printer sharing >Turn on public folder sharing..... >Enable file sharing for device..... >Allow windows to manage.....
- ❖ From Public select >Turn on Network Discovery >Turn on file and printer sharing >Turn on public folder sharing..... >Enable file sharing for device..... >Turn off password protected sharing.
- ❖ Click change Adapter Setting (Top left side of the window)
- ❖ You will find your network cable unplugged as shown in the figure 8.7.

Figure 8.7: Showing Network Cable Unplugged



Source: <http://xclusive4all.blogspot.in/2009/10/how-to-setup-local-area-connection-in.html>

- ❖ Plug your cable and then find local area connection as an unidentified network as shown in figure 8.8.

Figure 8.8: Showing unidentified Network



Source: <http://xclusive4all.blogspot.in/2009/10/how-to-setup-local-area-connection-in.html>

- Now setup your IP. Right click on Local Area Connection go to properties.
- Double click Internet protocol version 4 (TCP/IPv4) Or click properties
- Click Use the following IP address
- **IP address:** Give your IP address
- **Subnet mask:** Just press tab it will automatically generate (Default-255.255.255.0)
- Click use the following DNS server address.
- Click ok.

Finally all setting comes to an end. Now you can easily connect or disconnect your Local Area Connection.



**Caution** Follow the same procedure otherwise you will repeat a circular loop and can't move forward.

## Self Assessment

Fill in the blanks:

13. A ..... is a computer network that spans a relatively small area.
14. LAN ..... will automatically install when you setup windows 7.
15. The two methods for assigning IP addresses are Home to work and .....

### 8.3 Summary

- IP stands for Internet Protocol was developed with the objective to specify a suite of protocols capable of providing transparent communications interoperability services between computers of all sizes, regardless of the hardware or operating system platforms supporting them.
- Most users rely on IP for the purpose of file transfers, electronic mail (e-mail), and remote login services.
- The IP datagram has a header of 20-byte fixed size and a text of variable length optional parts.
- The IP header consists of five or six 32-bit words; the sixth word is attributed to the IP options field.
- Internet is the collection of several independent networks, which are interconnected with one another.
- IPv4 addresses are uniquely used as identifiers, which work at network layer to identify the source or destination of IP packets.
- IP addresses may have fixed part and variable part depending upon the allocation of total addresses to you or your organization.
- LAN (Local Area Network) card will automatically install when you setup windows 7.

### 8.4 Keywords

**Broadcast:** It is allocated to all network interfaces located on a subnet and is used for one-to-everyone on a subnet communication.

**Host ID:** The host ID, which is a host address portion of an IP unicast address, identifies a network node to which some devices are interfaced.

**Internet Header Length (IHL):** It indicates the length of the header field in 32-bit words. The minimum value of the header field is 5 that apply when no option is present.

**Internet Protocol:** The Internet Protocol (IP) is the method or protocol by which data is sent from one computer to another on the Internet.

**IPv4 Addressing:** IPv4 addresses are uniquely used as identifiers, which work at network layer to identify the source or destination of IP packets.

**Local Area Network:** A local-area network (LAN) is a computer network that spans a relatively small area.

**Multicast:** It is used for one or more network interfaces located on various subnets.

**Subnet prefix:** The subnet prefix is basically network identifier or network address portion of an IP unicast address.

**Unicast:** It is assigned to a single network interface located on a specific subnet and facilitates one-to-one communication.

### 8.5 Review Questions

1. Define Internet Protocol.
2. Discuss the role of Data encapsulation in IP header.

3. Explain IPv4 Addressing. Highlight its classification.
4. IP addresses may have fixed part and variable part depending upon the allocation of total addresses to you or your organization. Comment.
5. Explain the concept of Dotted Decimal Notation.
6. What are the different classes of Internet Addresses?
7. Describe Subnetting for IP Addresses with the help of example.
8. Discuss the guidelines that are to be followed to implement subnetting.
9. Illustrate the steps for setting up a computer on LAN.
10. Discuss the ways used to assign IP addresses in a LAN?

Notes

### Answers: Self Assessment

- |                                 |                       |
|---------------------------------|-----------------------|
| 1. IP Protocol                  | 2. Data encapsulation |
| 3. Fragment offset              | 4. Version            |
| 5. Internet Header Length (IHL) | 6. IPv4               |
| 7. binary                       | 8. subnet prefix      |
| 9. Multicast                    | 10. host ID           |
| 11. Address                     | 12. Subnetting        |
| 13. local-area network (LAN)    | 14. Card              |
| 15. Public                      |                       |

### 8.6 Further Readings



Books

Barrett, Diane. & King, Todd (2005). *“Computer networking illuminated.”* Jones & Bartlett Learning.

Blundell, Barry (2008). *“Computer hardware.”* Cengage Learning EMEA.

Englander, Irv (2003). *“The architecture of computer hardware and systems software: An Information Technology Approach.”* Wiley.

Sarkar, Nurul (2006). *“Tools for Teaching Computer Networking And Hardware Concepts.”* Information Science Pub.

Shinder, Bebra Littlejohn (2001). *“Computer Networking Essentials.”* Cisco Press.



Online links

[http://archives.mysteryfcm.co.uk/networking/docs/setting\\_up\\_a\\_local\\_area\\_network.pdf](http://archives.mysteryfcm.co.uk/networking/docs/setting_up_a_local_area_network.pdf)

<http://documentation.netgear.com/dg834n/enu/202-10197-02/Advanced.7.3.html>

<http://en.kioskea.net/contents/pratique/lan.php3>

<http://www.ibm.com/developerworks/library/l-lan/index.html>



**LOVELY PROFESSIONAL UNIVERSITY**

Jalandhar-Delhi G.T. Road (NH-1)  
Phagwara, Punjab (India)-144411  
For Enquiry: +91-1824-521360  
Fax.: +91-1824-506111  
Email: [odl@lpu.co.in](mailto:odl@lpu.co.in)

978-81-946273-4-0



9 788194 627340