

Control Engineering Problems with Solutions

Derek P. Atherton

Derek P. Atherton

Control Engineering Problems with Solutions

Control Engineering Problems with Solutions

1st Edition

© 2015 Derek P. Atherton & bookboon.com

ISBN 978-87-403-0374-2

Contents

	Preface	7
1	Introduction	8
1.1	Purpose	8
2	Mathematical Models and Block Diagrams	9
2.1	Introduction	9
2.2	Examples	12
2.3	Problems	26
3	Transfer Functions and their Time Domain Responses	31
3.1	Introduction	31
3.2	Examples	32
3.3	Problems	44

I joined MITAS because
I wanted **real responsibility**

The Graduate Programme
for Engineers and Geoscientists
www.discovermitas.com



Month 16

I was a construction
supervisor in
the North Sea
advising and
helping foremen
solve problems

Real work
International opportunities
Three work placements



 **MAERSK**

4	Frequency Responses and their Plotting	47
4.1	Introduction	47
4.2	Examples	47
4.3	Problems	59
5	Feedback Loop Stability	62
5.1	Introduction	62
5.2	Examples	63
5.3	Problems	84
6	State Space Models and Transformations	88
6.1	Introduction	88
6.2	Examples	88
6.3	Problems	116
7	Control System Design	123
7.1	Introduction	123
7.2	Examples	124
7.3	Problems	148



www.job.oticon.dk

oticon
PEOPLE FIRST



8	Phase Plane Analysis	154
8.1	Introduction	154
8.2	Examples	154
8.3	Problems	168
9	The Describing Function and Exact Relay Methods	172
9.1	Introduction	172
9.2	Examples	172
9.3	Problems	195



Schlumberger

WHY WAIT FOR PROGRESS?

DARE TO DISCOVER

Discovery means many different things at Schlumberger. But it's the spirit that unites every single one of us. It doesn't matter whether they join our business, engineering or technology teams, our trainees push boundaries, break new ground and deliver the exceptional. If that excites you, then we want to hear from you.

careers.slb.com/recentgraduates



Preface

The purpose of this book is to provide both worked examples and additional problems, with answers only, which cover the contents of the two **Bookboon books** ‘Control Engineering: An introduction with the use of Matlab’ and ‘An Introduction to Nonlinearity in Control Systems’. Although there was considerable emphasis in both books on the use of Matlab/Simulink, such usage may not always be possible, for example for students taking examinations. Thus in this book there are a large number of problems solved ‘long hand’ as well as by Matlab/Simulink. A major objective is to enable the reader to develop confidence in analytical work by showing how calculations can be checked using Matlab/Simulink. Further by plotting accurate graphs in Matlab the reader can check approximate sketching methods, for say Nyquist and Bode diagrams, and by obtaining simulation results see the value of approximations used in solving some nonlinear control problems.

I wish to acknowledge the influence of many former students in shaping my thoughts on many aspects of control engineering and in relatively recent years on the use of Matlab. In particular, Professor Dingyu Xue whose enthusiasm for Matlab began when he was a research student and who has been a great source of knowledge and advice for me on its use since that time, and to Dr. Nusret Tan for his assistance and advice on some Matlab routines. I wish to thank the University of Sussex for the facilities they have provided to me in retirement which have been very helpful in writing all three bookboon books and finally to my wife Constance for her love and support over many years.

Derek P. Atherton

University of Sussex

Brighton

May 2015

1 Introduction

1.1 Purpose

The purpose of this book is to provide both worked examples and additional problems, with answers only, which cover the contents of the two **Bookboon books** Control Engineering: An introduction with the use of Matlab[1] and An Introduction to Nonlinearity in Control Systems [2], which will be referred to as references 1 and 2, respectively, throughout this book. In reference 1 the emphasis in the book was to show how the use of Matlab together with Simulink could avoid the tedium of doing some calculations, however, there are situations where this may not be possible, such as some student examinations. Thus in this book as well as working out in many cases the examples ‘long hand’, the solutions obtained using Matlab/Simulink are also given. Matlab not only allows confirmation of the calculated results but also provides accurate graphs of say Nyquist plots or root locus diagrams where an examination question may ask for a sketch. Academics have been known to say they gained significant knowledge of a topic from designing exercises for students. Unlike 50 years ago when slide rules and logarithmic tables were used to solve problems designing exercises is now much easier because in most instances results can be checked using appropriate computer programs, such as Matlab. Thus with these tools students can build their own exercises and gain confidence in solving them by doing appropriate checks with software.

The examples and problems have been carefully chosen to try and bring out different aspects and results of problem solving without, hopefully creating too much repetition, which can ‘turn off’ the most ardent enthusiast. Before the examples in each chapter a very brief overview of aspects of the topics covered is given but more details can be found in the relevant chapters of references 1 or 2, which are referred to in the relevant chapters of this book.

References

1. Control Engineering: An introduction with the use of Matlab, D.P. Atherton. Bookboon 2009.
2. An Introduction to Nonlinearity in Control Systems. D.P. Atherton. Bookboon 2011.

Contents Overview

The examples and problems are included under the following topic titles.

2. Mathematical Models and Block Diagrams.
3. Transfer Functions and their Time Domain Responses.
4. Frequency Responses and their Plotting
5. Feedback Loop Stability
6. State Space Models and Transformations
7. Control System Design.
8. Phase Plane Analysis
9. The Describing Function and Exact Relay Methods.

2 Mathematical Models and Block Diagrams

2.1 Introduction

Block diagrams are used by engineers to show how the possibly large number of components, which are present in many systems, are interconnected. The information in a block may be purely descriptive, such as that shown in Figure 2.1, which describes the components of a typical measurement system, or contain a mathematical model of the various components which is required if any dynamic analysis is to be undertaken, which will be our concern here.

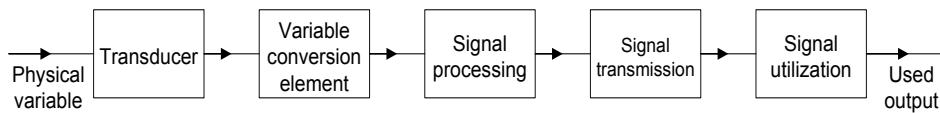

Figure 2.1 Components of a typical measurement system.

The basic mathematical model of a component with lumped parameters is a differential equation. Although all component models are nonlinear one may often be able to approximate them under certain conditions by a linear differential equation. Control engineers usually work with two equivalents of a linear differential equation, a transfer function or a state space model, as described in chapter 2 of reference 1. Thus a component model is typically shown by a block and labelled with its transfer function $G(s)$ as shown in Figure 2.2, where the input to the block is labelled $U(s)$ and the output $Y(s)$. This means that $Y(s) = G(s)U(s)$, where $U(s)$ is the Laplace transform of the input signal $u(t)$ and $Y(s)$ is the Laplace transform of the output signal $y(t)$. The corresponding relationship in the time domain is the convolution integral, see appendix A reference 1, given by $y(t) = \int_0^t g(t-\tau)u(\tau)d\tau = \int_0^t g(\tau)u(t-\tau)d\tau$, where $g(t)$ the weighting function, or impulse response, of the block has the Laplace transform $G(s)$. It is normally understood that when the lower case is used, i.e u , it is a function of t and when the upper cases is used, i.e U it is a function of s .

The first set of examples will be concerned with model representations for a single block. The transfer function of a component, assumed to behave linearly, is the Laplace transform of its linear constant parameter differential equation model, assuming all initial conditions are zero. This transfer function, typically denoted by, $G(s)$, will be the ratio of two rational polynomials with real coefficients, that is $G(s) = B(s)/A(s)$. The roots of $A(s)$ and $B(s)$ respectively are the poles and zeros of $G(s)$. A transfer function is strictly proper when it has more poles than zeros. When the number of poles is equal to the number of zeros the transfer function is said to be proper. The transfer function is stable if all its poles have negative real parts. In Matlab the transfer function is typically entered by declaring the coefficients of the polynomials $A(s)$ and $B(s)$ or in the zero-pole-gain form. A state space model represents an n^{th} order differential equation by a set of n first order differential equations represented by four matrices A , B , C and D . For a single-input single-output system (SISO) the dimensions are $n \times n$; $1 \times n$, an n column vector; $n \times 1$, an n row vector, and 1×1 , a scalar. Whilst a state representation has a unique transfer function the reverse is not true. Some simple aspects of state space representations will be covered here with more in chapter 6.

The interconnection of model blocks is typically shown in a block diagram or signal flow graph where only the former will be considered here. Often the 's' is dropped in the block diagram so that the relationship for Figure 2.2 is typically denoted by $Y = GU$.

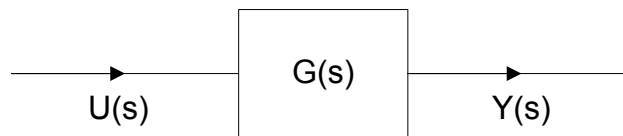

Figure 2.2 Single block representation.

In connecting block diagrams it is assumed that the connection of one block G_2 to the output of another G_1 does not load the former so that if $X = G_1U$ and $Y = G_2X$ then $Y = G_2G_1X$ as shown in Figure 2.3

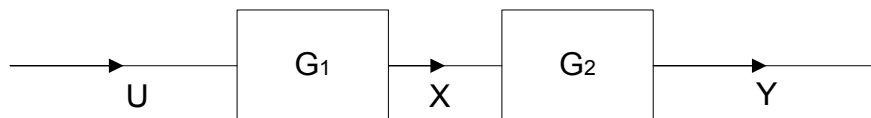

Figure 2.3 Series connection of blocks.

For two blocks in parallel with $Y_1 = G_1U$, $Y_2 = G_2U$ and $Y = Y_1 + Y_2$ then $Y = (G_1 + G_2)U$. In Matlab the series connection notation is $G_1 * G_2$ and the parallel one $G_1 + G_2$. Figure 2.4 shows a simple feedback loop connection for which the relationships for the two blocks are $C = GX$ and $Y = HC$ with $X = R - Y$. Eliminating X to get the closed loop transfer function, T , between the input R and output C gives

— ———

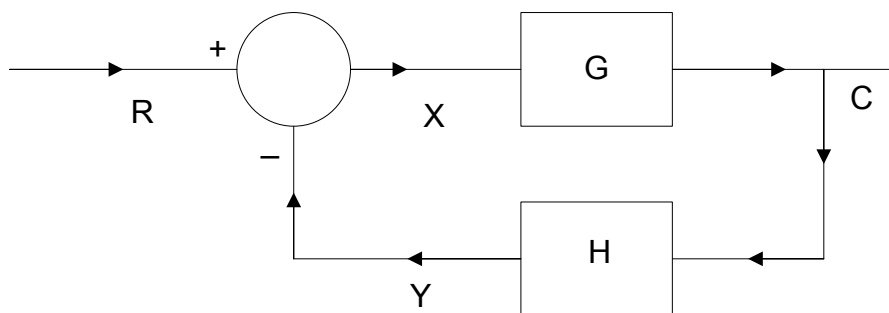

Figure 2.4 Closed loop block diagram

The required command in Matlab is $T=feedback(G,H)$. If the positive feedback configuration is required then the required statement is $T=feedback(G,H,sign)$ where the $sign = 1$. This can also be used for the negative feedback with $sign = -1$. Block diagrams and signal flow graphs, an alternative graphical representation which will not concern us here, simply describe sets of simultaneous equations. Often textbooks give sets of rules for manipulating block diagrams and obtaining relationships between the variables involved but in many engineering problems there are not many interconnections between blocks and one can work from first principles writing out expressions and eliminating variables as done above.



The standard single-input single-output feedback control loop is typically assumed to be of the form shown in Figure 2.5. G , G_c and H are respectively the transfer functions of the plant, controller and measurement transducer, and the input signals R , D and N are respectively the reference or command input, a disturbance and measurement noise. U is the control signal to the plant and C the output or controlled variable. The open loop transfer function, $G_c G H$, is the transfer function around the loop with the negative feedback assumed, that is with 's' omitted, $G_c G H$. The closed loop transfer function C/R is often denoted by T . The error is the difference between the demanded output and the actual output C . Normally the units of R and C will be different, for example C might be a speed and R a voltage with the transducer H having units of $V/\text{rads/s}$. Typically, the feedback loop is designed to achieve zero error between R and $H C$, which will be a voltage. The error in speed will be $C - R/H$, which with no voltage error will only be the demanded speed if H is known exactly. The transfer function from the input to the error at the input to G_c is $1 - T H$

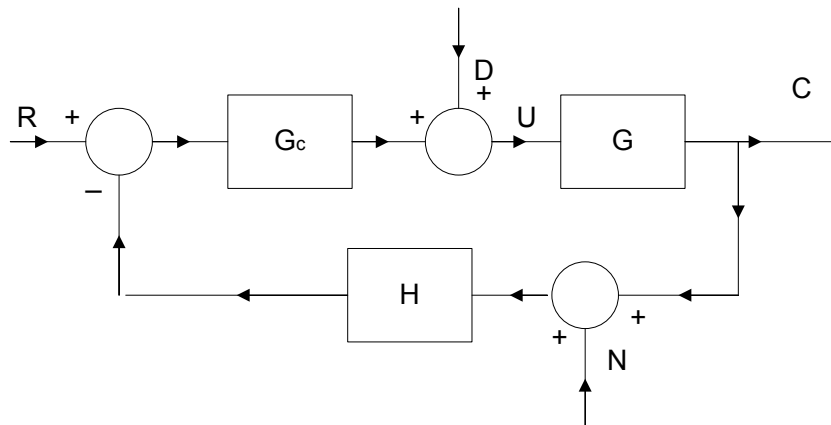

Figure 2.5 Basic feedback control loop

The first two examples deal with transfer functions and their zeros and poles, and are followed by three examples dealing with the interconnection of transfer functions and their evaluation in Matlab. Mathematical models can also be entered and their responses to different inputs found using Simulink. The 'Continuous' category of Simulink includes the following model forms, transfer function blocks for either polynomial or zero pole form of entry, a state space block, an integrator block. The 'Math operations' category, includes a gain block and a sumer. The next example covers a few basic aspects of using these blocks in Simulink.

2.2 Examples

Example 2.1

Find the poles and zeros of the transfer function $G(s) = \frac{s+1}{s^3 + 3s^2 + 3s + 2}$.

To find the poles one needs to find the roots of the denominator polynomial $s^3 + 3s^2 + 3s + 2 = 0$. Since it is a cubic with real parameters it must have one real root and a quick check shows one root is -2 . Dividing the polynomial by $s + 2$ yields $s^2 + s + 1$ which has roots of $s = -(1/2) \pm j(\sqrt{3}/2)$. Thus the transfer function has a zero at -1 , and three poles at -2 and $-(1/2) \pm j(\sqrt{3}/2)$. Using Matlab one has

```
>> G=tf([1 1],[1 3 3 2])
```

Transfer function:

$$\frac{s + 1}{s^3 + 3s^2 + 3s + 2}$$

The zero-pole gain version can then be obtained from Matlab with the following instruction:-

```
>> zpk(G)
```

Zero/pole/gain:

$$\frac{(s+1)}{(s+2)(s^2 + s + 1)}$$

Note the complex roots are returned as a second order polynomial.

Alternatively the transfer function could have been entered in zero-pole-gain form as below and the transfer function in polynomial form found.

```
>> G=zpk(-1,[-2 -0.5+0.866j -0.5-0.866j],1)
```

Zero/pole/gain:

$$\frac{(s+1)}{(s+2)(s^2 + s + 1)}$$

>> tf(G)

Transfer function:

$$s + 1$$

$$s^3 + 3s^2 + 3s + 2$$

In a practical situation 'nice' numbers will not occur and polynomials can have much higher orders than three so use of computational software such as Matlab is essential as indicated by the next example.

Example 2.2.

Find the poles and zeros of the transfer function

Click here to learn more

TAKE THE
RIGHT TRACK

Give your career a head start
by studying with us. Experience the advantages
of our collaboration with major companies like
ABB, Volvo and Ericsson!

Apply by
15 January

World class
research

www.mdh.se

MÄLARDALEN UNIVERSITY
SWEDEN



Click on the ad to read more

Finding the roots of the denominator because the polynomial is of fifth order requires quite a bit of trial and error and would be even worse for a practical situation where the polynomial coefficients would not be integers. The roots command in Matlab gives

```
>> roots([1 6 14 21 13 6])
```

ans =

-3.4212

-0.9474 + 1.5690i

-0.9474 - 1.5690i

-0.3421 + 0.6365i

-0.3421 - 0.6365i

Thus these are the poles, which are seen to be one real and two complex pairs, and the zeros are easily seen to be -2 and -3. As all the poles have negative real parts the transfer function is stable.

Example 2.3

Find the transfer function of (a) the series and (b) the parallel combinations of the two transfer functions

$$G_1(s) = \frac{(s+2)}{(s+1)^2(s^2+s+4)} \text{ and } \text{_____}$$

Note that in the product G_1G_2 the zero at $s = -2$ from G_1 cancels the pole at $s = -2$ of G_2 giving:-

$$G_1G_2 = \frac{s+4}{(s+1)^3(s^2+s+4)}. \text{ What happens in Matlab?}$$

The first transfer function G_1 can be entered by making use of the convolution instruction 'conv' as follows:-

```
>> G1=tf([1 2],[conv([1 2 1],[1 1 4])])
```

Transfer function:

s + 2

s^4 + 3 s^3 + 7 s^2 + 9 s + 4

```
>> G2=tf([1 4],[1 3 2]);
```

```
>> G=G1*G2
```

Transfer function:

$$s^2 + 6s + 8$$

$$s^6 + 6s^5 + 18s^4 + 36s^3 + 45s^2 + 30s + 8$$

Thus the zero pole cancellation has not been done by Matlab. This can be done, however, by using the instruction 'minreal', short for minimal realisation. Thus

```
>> G=minreal(G1*G2)
```

Transfer function:

$$s + 4$$

$$s^5 + 4s^4 + 10s^3 + 16s^2 + 13s + 4$$

To check that the denominator agrees with the above for the product of G1 and G2 one can use the zpk function to obtain:-

```
>> zpk(G)
```

Zero/pole/gain:

$$(s+4)$$

$$(s+1)^3 (s^2 + s + 4).$$

For the parallel connection of the transfer functions

giving

And using Matlab

```
>> GP=minreal(G1+G2)
```

Transfer function:

$$s^4 + 6s^3 + 14s^2 + 28s + 20$$

$$s^5 + 5s^4 + 13s^3 + 23s^2 + 22s + 8$$

Here again if minreal is not used then the denominator is of sixth power as $(s + 1)^3$ is included.

Example 2.4

Determine the transfer functions for the basic feedback loop block diagram of Figure 2.5 from the input R and disturbance D to the output and the error at the input to G_c , respectively, with _____ and $H = 1$.



How will people travel in the future, and how will goods be transported? What resources will we use, and how many will we need? The passenger and freight traffic sector is developing rapidly, and we provide the impetus for innovation and movement. We develop components and systems for internal combustion engines that operate more cleanly and more efficiently than ever before. We are also pushing forward technologies that are bringing hybrid vehicles and alternative drives into a new dimension – for private, corporate, and public use. The challenges are great. We deliver the solutions and offer challenging jobs.

www.schaeffler.com/careers

SCHAEFFLER

WE ARE SHAPING MOBILITY FOR TOMORROW



The closed loop transfer function ————— which on substituting the values given gives

————— and if the input to G_c

is denoted by E , since , gives —————, which on substituting the values gives

—————

Using Matlab and after entering the transfer functions T is obtained from

```
>> T=feedback(Gc*G,1)
```

Transfer function:

$$2 s + 2$$

—————

$$0.25 s^4 + 1.25 s^3 + 2 s^2 + 6 s + 2$$

And E/R from $1-T$, that is

```
>> 1-T
```

Transfer function:

$$0.25 s^4 + 1.25 s^3 + 2 s^2 + 4 s$$

—————

$$0.25 s^4 + 1.25 s^3 + 2 s^2 + 6 s + 2$$

The transfer function from D to the output corresponds to a negative feedback loop with input D , feedforward element, G , and feedback element G_c and is

—————

```
>> CD=feedback(G,Gc)
```

Transfer function:

$$0.5s + 2$$

$$0.25s^4 + 1.25s^3 + 2s^2 + 6s + 2$$

With the input R zero the transfer function $\frac{E}{D} = -\frac{C}{D}$.

Note the denominator polynomial of the transfer functions is always the same and its roots define the stability of the loop, thus from Matlab

```
>> roots([0.25 1.25 2 6 2])
```

ans =

- 4.3336
- 0.1487 + 2.2317i
- 0.1487 - 2.2317i
- 0.3690

Which all have negative real parts showing the feedback loop is stable.

Example 2.5

Figure 2.6 shows a block diagram with two feedback loops for which the transfer functions are

$$G_1(s) = \frac{1 + 4s}{4 + 4s}, \quad G_2(s) = \frac{1}{1 + 0.5s}, \quad G_3(s) = \frac{1}{1 + s + s^2}, \quad G_4(s) = \frac{1}{s}, \quad H_1(s) = \frac{1}{1 + 0.1s}$$

and $H_2(s) = \frac{s}{1 + 0.2s}$. Find the transfer functions from the input R and disturbance D to the output C.

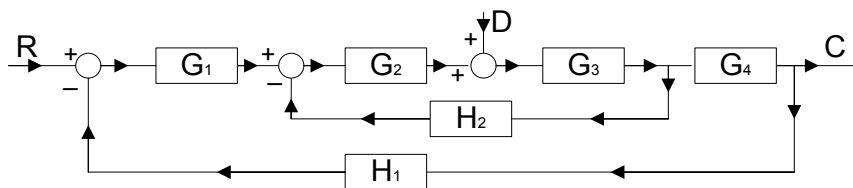

Figure 2.6 Block diagram for example 2.5

To show the possible approaches the transfer functions will first be derived in terms of the block descriptors. To find the transfer function from R to C , which will be denoted by T , it is possibly easiest to derive the closed loop transfer function of the inner loop first. Denoting this by T_1 gives

$$T_1 = \frac{G_2 G_3}{1 + G_2 G_3 H_2} \text{ and then the transfer function } T \text{ is given by}$$

$$T = \frac{G_1 T_1 G_4}{1 + G_1 T_1 G_4 H_1} = \frac{G_1 G_2 G_3 G_4}{1 + G_2 G_3 H_2 + G_1 G_2 G_3 G_4 H_1}.$$

Alternatively the inner feedback loop can be replaced by noting that the total negative feedback from C to the input to G_1 is $H_1 + \frac{H_2}{G_4 G_1}$ so that, T , can be written

$$T = \frac{G_1 G_2 G_3 G_4}{1 + (H_1 + \frac{H_2}{G_4 G_1}) G_1 G_2 G_3 G_4} = \frac{G_1 G_2 G_3 G_4}{1 + G_2 G_3 H_2 + G_1 G_2 G_3 G_4 H_1} \text{ as before.}$$

Substituting the transfer function values gives

STUDY FOR YOUR MASTER'S DEGREE IN THE CRADLE OF SWEDISH ENGINEERING

Chalmers University of Technology conducts research and education in engineering and natural sciences, architecture, technology-related mathematical sciences and nautical sciences. Behind all that Chalmers accomplishes, the aim persists for contributing to a sustainable future – both nationally and globally.

Visit us on Chalmers.se or **Next Stop Chalmers** on facebook.



Using Matlab after the transfer functions have been entered gives

```
>> T1=feedback(G2*G3,H2)
```

Transfer function:

$$0.2 s + 1$$

$$0.1 s^4 + 0.8 s^3 + 1.8 s^2 + 2.7 s + 1$$

and

```
>> T=feedback(G1*T1*G4,H1)
```

Transfer function:

$$0.08 s^3 + 1.22 s^2 + 4.3 s + 1$$

$$0.04 s^7 + 0.76 s^6 + 4.64 s^5 + 12.2 s^4 + 19.48 s^3 + 16 s^2 + 8.2 s + 1$$

The roots of the denominator are

```
>> roots([0.04 0.76 4.64 12.2 19.48 16 8.2 1])
```

ans =

$$-10.0031$$

$$-5.5809$$

$$-1.1400 + 1.4462i$$

$$-1.1400 - 1.4462i$$

$$-0.4851 + 0.7490i$$

$$-0.4851 - 0.7490i$$

$$-0.1658$$

Thus the system is stable.

The transfer function from D to C , which will be denoted F , is simply a forward path of G_3G_4 and a negative feedback path of $G_1G_2H_1 + \frac{G_2H_2}{G_4}$ which gives

$$F = \frac{G_3G_4}{1 + G_3G_4(G_1G_2H_1 + \frac{G_2H_2}{G_4})} = \frac{G_3G_4}{1 + G_2G_3H_2 + G_1G_2G_3G_4H_1}$$

Using Matlab

```
>> F=feedback(G3*G4,G1*G2*H1+G2*H2*inv(G4))
```

Transfer function:

$$0.02 s^5 + 0.4 s^4 + 2.66 s^3 + 7.48 s^2 + 9.2 s + 4$$

$$0.02 s^8 + 0.42 s^7 + 3.08 s^6 + 10.74 s^5 + 21.94 s^4 + 27.48 s^3 + 20.1 s^2 + 8.7 s + 1$$

```
>> minreal(F)
```

Transfer function:

$$s^4 + 18 s^3 + 97 s^2 + 180 s + 100$$

$$s^7 + 19 s^6 + 116 s^5 + 305 s^4 + 487 s^3 + 400 s^2 + 205 s + 25$$

Note the denominator polynomial is the same as that of T , its coefficients are all multiplied by 25, as expected.

Example 2.6

Enter the transfer $\frac{1}{s^2+3s+2}$ into Simulink using transfer function blocks, a state space representation, and using integrators?

The simplest approach is to use one block, but other possibilities are to do as a series or parallel combination (partial fraction representation – see also chapter 3) as shown in Figure 2.7 as models 1, 2 and 3 respectively.

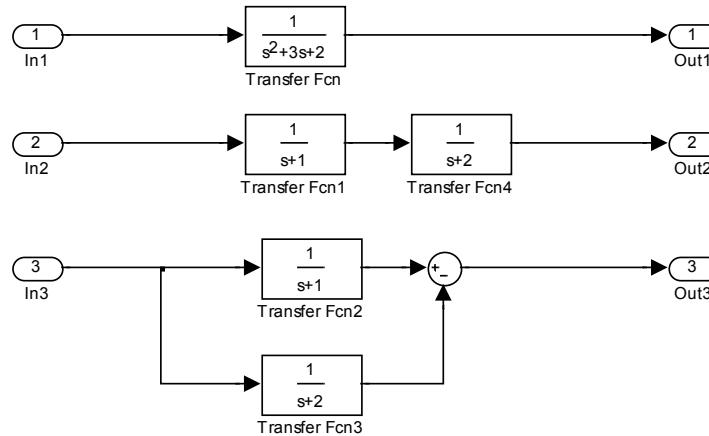

Figure 2.7 Possible transfer function representations



Scholarships



Open your mind to new opportunities

With 31,000 students, Linnaeus University is one of the larger universities in Sweden. We are a modern university, known for our strong international profile. Every year more than 1,600 international students from all over the world choose to enjoy the friendly atmosphere and active student life at Linnaeus University. Welcome to join us!

Linnaeus University
Sweden

Bachelor programmes in
Business & Economics | Computer Science/IT | Design | Mathematics

Master programmes in
Business & Economics | Behavioural Sciences | Computer Science/IT | Cultural Studies & Social Sciences | Design | Mathematics | Natural Sciences | Technology & Engineering

Summer Academy courses

Ln.u.se



The use of an integration block has the advantage that an initial condition can be placed on its output. Thus when modelling using integrators their set of outputs provide a possible state vector. For the single integrator with input gain and feedback shown in Figure 2.8 the state equation is simply $\dot{x} = -ax + bu$ and the output equation $y = cx$ which corresponds to a transfer function of $\frac{c}{s+a}$ if no initial condition is placed on the output x of the integrator.

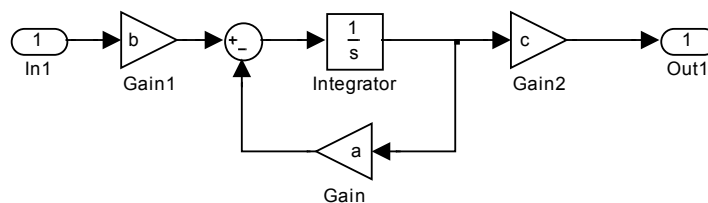

Figure 2.8 Integrator with feedback

Note that the numerator of the transfer function, given any specific value, h , can be split arbitrarily between b and c . It is quite common to take $b = 1$ and $c = h$. Thus in the diagram of Figure 2.7 any of the first order transfer functions in the approaches 2 and 3 could have been replaced by the integrator implementation of Figure 2.8. For the first implementation, one simple approach using integrators, known as the controllable canonical form is shown in Figure 2.9.

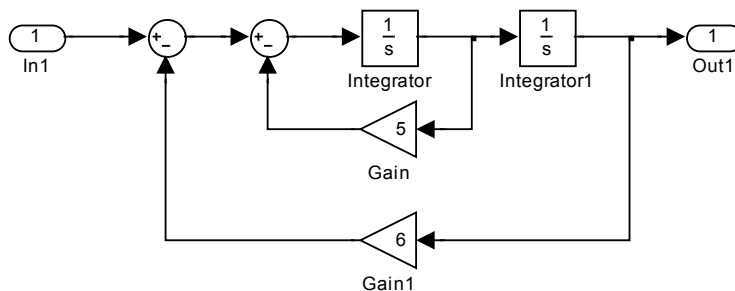

Figure 2.9 Model of second order transfer function using integrators.

The differential equation corresponding to the transfer function is $\ddot{x} + 5\dot{x} + 6x = u$ if the output is denoted by x and the input by u . In transform terms after rearranging this can be written as $(s^2 + 5s + 6)X = U$ which equates the two expressions available for the input to the first integrator. This approach can obviously be used to realise a characteristic equation of any order, where if it is of order n there will be n integrators in series and n feedback gain paths. Any of the three approaches to modelling the transfer function with integrators is a possible state space representation with the integrator outputs as the state vector. For the first representation in Figure 2.7 shown in Figure 2.9 the state relationships if the outputs of the integrators, from left to right, are respectively x_2 and x_1 are

$$\dot{x}_1 = x_2 \text{ and } \dot{x}_2 = -5x_2 - 6x_1 + u$$

Thus, denoting the state vector by x equal to $(x_1, x_2)^T$ the state equation

has $A = \begin{pmatrix} 0 & 1 \\ -6 & -5 \end{pmatrix}$ and $B = \begin{pmatrix} 0 \\ 1 \end{pmatrix}$, and the output equation is

For the second representation of Figure 2.7, with the state vector components being x_2 and x_1 , the outputs of the first and second time constants using integrators as in Figure 2.9, the equations will be

$\dot{x}_1 = -2x_1 + x_2$ and $\dot{x}_2 = -x_2 + u$ so that the state representation has

$$A = \begin{pmatrix} -2 & 1 \\ 0 & -1 \end{pmatrix}, B = \begin{pmatrix} 0 \\ 1 \end{pmatrix} \text{ and } C = (1 \ 0).$$

Finally for the third representation of Figure 2.7 and denoting the outputs of the integrators in the upper and lower time constants as, x_1 and x_2 respectively, gives a state representation with

$$A = \begin{pmatrix} -1 & 0 \\ 0 & -2 \end{pmatrix}, B = \begin{pmatrix} 1 \\ 1 \end{pmatrix} \text{ and } C = (1 \ 1).$$

Note that this approach yields a diagonal form for the A matrix, with the eigenvalues of the matrix (roots of the characteristic equation) on the diagonal. Any of these state representations may be used in Matlab or Simulink for which the state space block is shown in Figure 2.10.

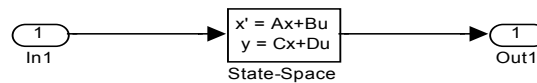

Figure 2.10 State space model in Simulink.

Entering the first (A,B,C,D) representation into Matlab as below can be used to find the transfer function

```
>> A=([0 1;-6 -5]);
```

```
>> B=([0;1]);
```

```
>> C=([1 0]);
```

```
>> D=0;
```

```
>> G=ss(A,B,C,D);
```

```
>> tf(G)
```

Transfer function:

1

$s^2 + 5s + 6$

2.3 Problems

Problem 2.1

Find the poles and zeros of the transfer function _____ and determine if it is stable. Check your result using Matlab.

[0, -2, -4, -0.5±0.866j; -1,-3; stable, all poles negative real part]

Problem 2.2

Find the poles and zeros of the transfer function _____ and determine if it is stable. Check your result using Matlab.

[0, -2, -4, 0.5±1.323j; -1,-3; unstable, complex poles positive real part]

Problem 2.3

Find the transfer function for the block diagram of Figure P2.3 in terms of the individual transfer functions. Determine its value if $G_1(s) = \frac{s+2}{s^2+s+1}$, $G_2(s) = \frac{1}{s+1}$ and $G_3(s) = \frac{2}{s+3}$. Find its poles and zeros.

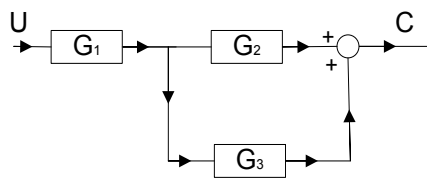

Figure P2.3

_____ -1, -3, -0.5±0.866j; -2, -5/3.]

Problem 2.4

Find two state representations for the transfer function of Problem 2.3 and check your result in Matlab.

[Controllable form of TF, $A = \begin{pmatrix} 0 & 1 & 0 & 0 \\ 0 & 0 & 1 & 0 \\ 0 & 0 & 0 & 1 \\ -3 & -7 & -8 & -5 \end{pmatrix}$, $B = \begin{pmatrix} 0 \\ 0 \\ 0 \\ 1 \end{pmatrix}$, $C^T = \begin{pmatrix} 10 \\ 11 \\ 3 \\ 0 \end{pmatrix}$, $D = 0$.

Controllable form for the TF G_1 and diagonal form for G_2 and G_3 . $A = \begin{pmatrix} 0 & 1 & 0 & 0 \\ -1 & -1 & 0 & 0 \\ 2 & 1 & -1 & 0 \\ 2 & 1 & 0 & -3 \end{pmatrix}$,

$$B = \begin{pmatrix} 0 \\ 1 \\ 0 \\ 0 \end{pmatrix}, C^T = \begin{pmatrix} 0 \\ 0 \\ 1 \\ 2 \end{pmatrix}, D = 0.]$$

Problem 2.5

Determine the transfer function for Figure P2.3 if $G_1(s) = \frac{s+1}{s^2+s+1}$, $G_2(s) = \frac{1}{s+1}$ and $G_3(s) = \frac{2}{s+3}$. Find its poles and zeros.

$$\left[\frac{3s+5}{s^3+4s^2+4s+3}; -3, -0.5 \pm 0.866j; -5/3. \right]$$

Problem 2.6

Find two state representations for the transfer function of Problem 2.5 and check your result in Matlab.

$$\left[\text{Controllable form for the TF, } A = \begin{pmatrix} 0 & 1 & 0 \\ 0 & 0 & 1 \\ -3 & -4 & -4 \end{pmatrix}, B = \begin{pmatrix} 0 \\ 0 \\ 1 \end{pmatrix}, C = (5 \ 3 \ 0), D = 0. \right]$$



e-learning for kids

- The number 1 MOOC for Primary Education
- Free Digital Learning for Children 5-12
- 15 Million Children Reached

About e-Learning for Kids Established in 2004, e-Learning for Kids is a global nonprofit foundation dedicated to fun and free learning on the Internet for children ages 5 - 12 with courses in math, science, language arts, computers, health and environmental skills. Since 2005, more than 15 million children in over 190 countries have benefitted from eLessons provided by EFK! An all-volunteer staff consists of education and e-learning experts and business professionals from around the world committed to making difference. eLearning for Kids is actively seeking funding, volunteers, sponsors and courseware developers; get involved! For more information, please visit www.e-learningforkids.org.

Controllable form for G_1 with no zero plus diagonal for pole at -3 , $A = \begin{pmatrix} 0 & 1 & 0 \\ -1 & -1 & 0 \\ 1 & 0 & -3 \end{pmatrix}$, $B = \begin{pmatrix} 0 \\ 1 \\ 0 \end{pmatrix}$,
 $C = (3 \ 0 \ -4)$, $D = 0$.]

Problem 2.7

Find the transfer functions C/R and C/D for the block diagram of Figure P2.7 in terms of the individual transfer functions. Determine their values in terms of K if: $G_1(s) = K$, $G_2(s) = \frac{1}{(s+1)^2}$, $G_3(s) = \frac{2}{s}$, $H_1(s) = 1$, and ——— Estimate the maximum value of K for stability from the transfer function poles and check with Matlab.

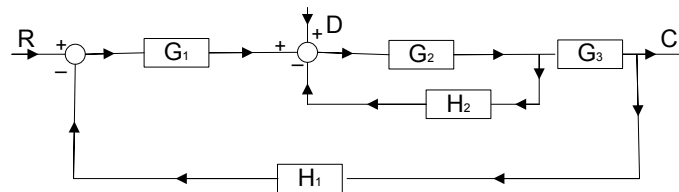

Figure P2.7

$$\left[\frac{C}{R} = \frac{G_1 G_2 G_3}{1 + G_2 H_2 + G_1 G_2 G_3 H_1}, \frac{C}{D} = \frac{G_2 G_3}{1 + G_2 H_2 + G_1 G_2 G_3 H_1} \right];$$

Problem 2.8

Determine the transfer functions C/R and C/D for Figure P2.7 in terms of K if: $G_1(s) = \frac{K(1+s)}{1+0.1s}$, $G_2(s) = \frac{1}{s+1}$, $G_3(s) = \frac{2}{s}$, $H_1(s) = 1$, and ——— Estimate the maximum value of K for stability from the transfer function poles and check with Matlab.

_____ Stable for all K .]

Problem 2.9

Find the transfer functions C/R and C/D for Figure P2.9 in terms of the individual transfer functions.

Determine their values in terms of K if:- $G_1(s) = K, G_2(s) = \frac{1}{s+2}, G_3(s) = \frac{2}{s+4}, G_4(s) = \frac{4}{s}, H_1(s) = 1,$ ——— and $H_3(s) = 2$. Estimate the maximum value of K for stability from the transfer function poles and check with Matlab.

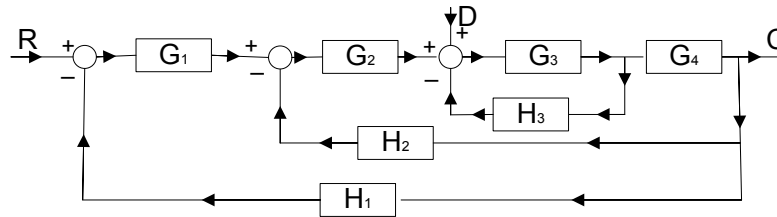

Figure P2.9

$$\left[\frac{C}{R} = \frac{G_1 G_2 G_3 G_4}{1 + G_3 H_3 + G_2 G_3 G_4 H_2 + G_1 G_2 G_3 G_4 H_1}, \frac{C}{D} = \frac{G_3 G_4}{1 + G_3 H_3 + G_2 G_3 G_4 H_2 + G_1 G_2 G_3 G_4 H_1} \right];$$

$$\frac{C}{R} = \frac{8K(s+10)}{s^4 + 20s^3 + 116s^2 + s(160 + 8K) + 80 + 80K},$$

$$\frac{C}{D} = \frac{8(s+2)(s+10)}{s^4 + 20s^3 + 116s^2 + s(160 + 8K) + 80 + 80K}; K = 18.27$$

Problem 2.10

Find the transfer functions C/R and C/D for Figure P2.10 in terms of the individual transfer functions.

Determine their values in terms of K if:- $G_1(s) = K, G_2(s) = \frac{1}{s+2}, G_3(s) = \frac{2}{s+4}, G_4(s) = \frac{4}{s}, H_1(s) = 1,$ ——— and $H_3(s) = 2$. Estimate the maximum value of K for stability from the transfer function poles and check with Matlab.

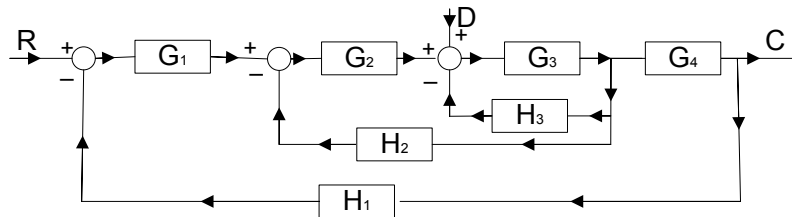

Figure P2.10

$$\left[\frac{C}{R} = \frac{G_1 G_2 G_3 G_4}{1 + G_3 H_3 + G_2 G_3 H_2 + G_1 G_2 G_3 G_3 H_1}, \frac{C}{D} = \frac{G_3 G_4}{1 + G_3 H_3 + G_2 G_3 H_2 + G_1 G_2 G_3 G_3 H_1}; \right.$$

$$\left. \frac{C}{R} = \frac{8K(s+10)}{s^4 + 20s^3 + 116s^2 + s(180 + 8K) + 80K}, \frac{C}{D} = \frac{8(s+2)(s+10)}{s^4 + 20s^3 + 116s^2 + s(180 + 8K) + 80K}; \right.$$

$$K = 21.75]$$

Problem 2.11

Some nonlinear systems are covered in later examples. Check that you can simulate the following nonlinear characteristics in Simulink by providing a sinusoidal input and looking at the characteristic input-output using an X-Y scope. (i) an ideal saturation with linear gain of 4 and output levels of ± 2 , (ii) an on-off relay with hysteresis with input switching levels of ± 0.5 and output levels of ± 2 , (iii) a relay with dead zone and hysteresis with input switching levels of ± 0.5 and ± 1.5 and output levels of 0 and ± 2 , (iv) a characteristic $x - (x^3 / 6)$.

Problem 2.12

The signal $y = \sin \theta + (1/3) \cos 3\theta$. Calculate its maximum value and check your result in Simulink by feeding the signal to a simout block and using the command `max(simout)`.

[0.471]

.....Alcatel-Lucent 

www.alcatel-lucent.com/careers

What if you could build your future and create the future?

One generation's transformation is the next's status quo. In the near future, people may soon think it's strange that devices ever had to be "plugged in." To obtain that status, there needs to be "The Shift".

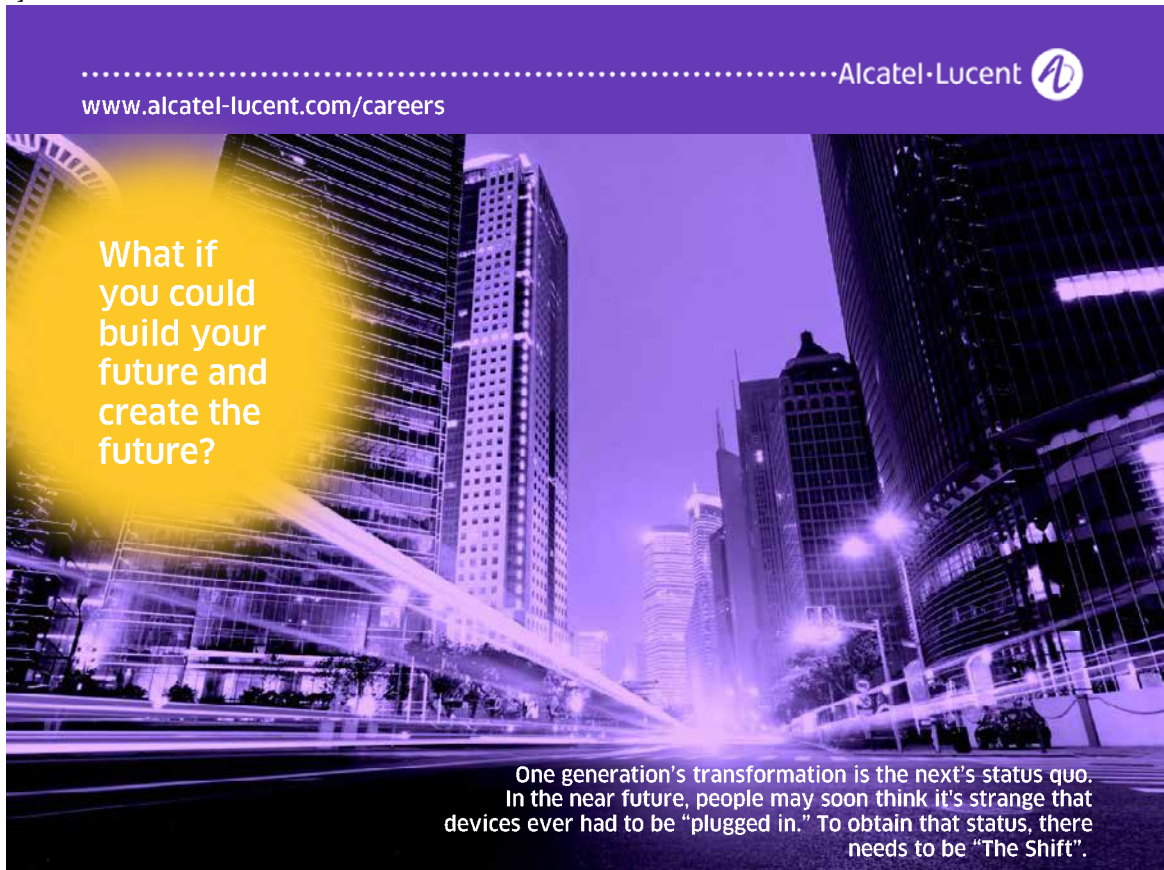

3 Transfer Functions and their Time Domain Responses

3.1 Introduction

In this section the examples and problems relate to the response of transfer functions, $G(s)$, to different inputs, covered in reference 1 chapter 3. If transfer functions with time delays, see reference 1 section 6.2, are neglected then as mentioned in the previous chapter, $G(s)$, will be the ratio of two rational polynomials with real coefficients, that is $G(s) = B(s)/A(s)$. Inputs to $G(s)$ will also be simple functions of s so finding the time response requires inversion of a function of a ratio of polynomials in s . This typically requires putting the function into partial fractions so that the inverse Laplace transform can be found. If the transfer function is proper then it must first be written as a constant plus a strictly proper transfer function. The constant will be the value of D in a state space representation. Many textbooks have tables of Laplace transforms but if multiple complex poles are neglected then a simple table, which can be used to invert transfer functions, in conjunction with the fact that s in the numerator can be taken as a derivative operator, is given below in Table 3.1. Note that the table could have been reduced further by noting that the result for poles at the origin can be found from that for multiple real poles for $n = 1 \dots \infty$ by taking the limit as $a \rightarrow 0$ and that the Laplace transform of $\delta(t)$ follows as the derivative of $u(t)$. Further number 4 has been added as it will be frequently used but is derived from 3, as suggested above, by differentiation. Thus the only results which are 'basic' are 2 and 3.

Poles at the origin	$\frac{1}{s^n} \leftrightarrow \delta(t)$ an impulse for $n = 0$. $u(t)$ a unit step for $n = 1$. _____ for all other n
Multiple real poles	$\frac{1}{(s+a)^n} \leftrightarrow$ _____ note for $n = 1, 0! = 1$
Complex poles	_____
Derivative of 3	_____

Table 3.1 Brief Table for Laplace Transforms

Then expand the numerator and compare the coefficients in the powers of s , thus for example the cubed term which is zero on the left hand side (lhs) and the constant term which is 2 on the lhs give $A + B + C + D = 0$ and _____ respectively. Similarly the s squared and s terms yield two more linear equations involving, and which can then be solved for, A, B, C and D . However, the quick approach is to recognise that eqn.(3.1) is valid for all values of s so that if both sides of the equation are multiplied by s and s is taken equal to zero then

_____ giving _____ as seen earlier. If the same procedure is done for $s + 1, s + 3$ and $s + 4$ with s put equal to $-1, -3$ and -4 one obtains

_____ Thus $B = -1/6, C = -1/6$ and $D = 1/6$. This procedure is often known as the cover up rule as to work out a residue one multiplies the expression by its denominator and then equates s to the pole value.

Nido

Luxurious accommodation

Central zone 1 & 2 locations

Meet hundreds of international students

BOOK NOW and get a £100 voucher from voucherexpress

Nido Student Living - London

Visit www.NidoStudentLiving.com/Bookboon for more info.

+44 (0)20 3102 1060



The solution for the output from inverting the rhs of eqn. (3.1) is $y(t)$. The first term in the brackets may also be written as $u(t)$ as the solution for $y(t)$ is only valid for $t > 0$. Note that the final value of the step response, see reference 1 appendix A, which can be obtained from either $\lim_{t \rightarrow \infty} y(t)$ or $\lim_{s \rightarrow 0} sY(s)$ is A which is equal to $1/6$. Also the initial value, which can be obtained from $\lim_{t \rightarrow 0} y(t)$ or $\lim_{s \rightarrow \infty} s^2 Y(s)$ is zero. When asked to sketch a step response it is useful to have the initial slope which can be obtained from differentiating $y(t)$ or in the s domain from $\lim_{s \rightarrow \infty} s^2 Y(s)$, as in the s domain the slope of $y(t)$ is $\lim_{s \rightarrow \infty} s^2 Y(s)$.

Matlab can be used to check partial fractions using the instruction `[r,p,k]=residue(num,den)` here r is the residue at the pole p , and k is only finite when the number of zeros is equal to the number of poles, i.e. when the transfer function is not strictly proper and is D in a state space representation. Thus for this example one has

```
>> num=[1 2];den=[1 8 19 12 0];
```

```
>> [r,p,k]=residue(num,den)
```

```
r =
```

```
0.1667
```

```
-0.1667
```

```
-0.1667
```

```
0.1667
```

```
p =
```

```
-4.0000
```

```
-3.0000
```

```
-1.0000
```

```
0
```

```
k =
```

```
[]
```

The step response which is obtained from the commands

```
>> G=tf([1 2],[1 8 19 12]);
```

```
>> step(G)
```

is given in figure 3.1, and obviously confirms the final value of $1/6 = 0.167$.

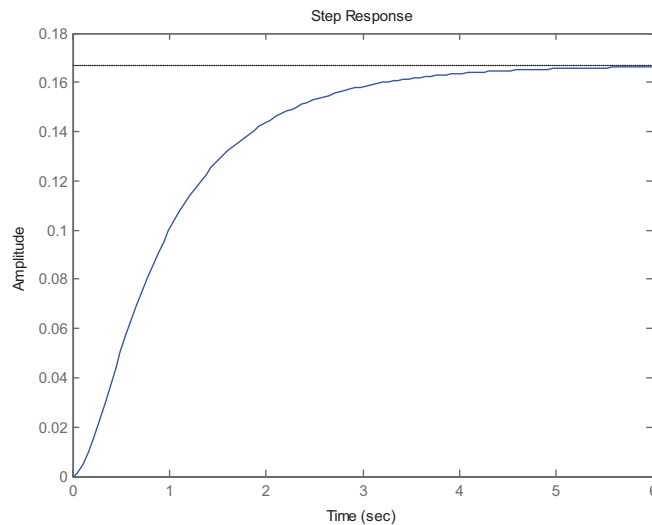

Figure 3.1 Step response of the transfer function

Example 3.2

To illustrate the problem of a repeated root consider the evaluation of the unit impulse response of

$$G(s) = \frac{1}{(s+1)^2(s+2)} .$$

Since the Laplace transform of a unit impulse is 1 it is required to find the inverse Laplace transform of $G(s)$. This can be put into partial fractions either as $\frac{A}{s+2} + \frac{B}{s+1} + \frac{C}{(s+1)^2}$ or

where B, C are related to D, E as is easily seen by bringing the last two terms in the first expression to a common denominator. Since the inverse Laplace transform of the first expression is often easier to write down the former is usually preferred. Using the cover up rule it is seen that $A = 1$ and $C = 1$. To find B it is probably easiest to then compare the numerator coefficients for one power of s . In this case the constant term looks easy and gives $A + 2B + 2C = 1$, which then yields $B = -1$. Thus the impulse response is

Matlab can again be used to check the partial fraction expansion and gives the following results

r =

1.0000

-1.0000

1.0000

$p =$

-2.0000

-1.0000

-1.0000

$k =$

[]

Note the residues are given for the partial fraction expansion involving A , B and C in that order.

Example 3.3

Find the poles and zeros and the unit step response of the transfer function $G(s) = \frac{s + 2}{s^2 + s + 1}$.

SIMPLY CLEVER

WE WILL TURN YOUR CV INTO AN OPPORTUNITY OF A LIFETIME



Do you like cars? Would you like to be a part of a successful brand?
As a constructor at ŠKODA AUTO you will put great things in motion. Things that will ease everyday lives of people all around Send us your CV. We will give it an entirely new new dimension.

Send us your CV on www.employerforlife.com



There is a zero at $s = -2$ and there are two complex poles at $s = -0.5 \pm j\sqrt{3}/2$, obtained from the roots of $s^2 + s + 1 = 0$, found either by using the expression for the roots of a quadratic or going back to the basics of 'completing the square', i.e. writing the expression as $(s + 0.5)^2 + (\sqrt{3}/2)^2 = 0$, which is how the expression for the roots of a quadratic equation was derived. The output

_____ with the residue at the pole $s = 0$ found by the cover up rule. By comparing the numerator coefficients for the s and s^2 terms one has $2 + A = 0$ and $2 + B = 1$ giving $A = -2$ and $B = -1$. Thus inversion, using Table 3.1, of $Y(s)$ gives

_____ which on simplification gives $y(t) = 2 - 2e^{-(t/2)} \cos(\sqrt{3}t/2)$.

Alternatively if one uses the results given in typical Laplace transform tables one writes

_____ which gives as before
 $y(t) = 2 - 2e^{-(t/2)} \cos(\sqrt{3}t/2)$.

In this case if one uses Matlab to get the partial fractions the result shows the residues at the complex poles as seen below

```
>> num=[1 2];
```

```
>> den=[1 1 1 0];
```

```
>> [r,p,k]=residue(num,den)
```

```
r =
```

```
-1.0000 + 0.0000i
```

```
-1.0000 - 0.0000i
```

```
2.0000
```

```
p =
```

```
-0.5000 + 0.8660i
```

$$-0.5000 - 0.8660i$$

$$0$$

$$k =$$

$$[]$$

Thus one has $Y(s) = \frac{2}{s} - \frac{1}{s + 0.5 - 0.866j} - \frac{1}{s + 0.5 + 0.866j} = \frac{2}{s} - \frac{2s + 1}{s^2 + s + 1}$ as before.

Example 3.4

Determine the values of c for which the step response of the transfer function _____ will have an overshoot. Confirm your result using Matlab and obtain plots of the step response for c equal to 0.5, 1, 1.5 and 2.

Comment

Many students think that there will be no overshoot when a transfer function has real negative poles. This may not be the case when there are zeros as this simple example illustrates.

Putting _____ into partial fractions gives $\frac{0.5}{s} - \frac{1}{s+1} + \frac{0.5}{(s+2)}$ which on taking the inverse Laplace transform gives in the time domain $0.5 - e^{-t} + 0.5e^{-2t}$. Thus the response of $G(s)$ to a unit step is $1 - 2e^{-t} + e^{-2t} + 2ce^{-t} - 2ce^{-2t}$, which has a final value of 1 {also given by $G(0)$ }.

Differentiating and equating to zero to find the maximum gives

$e^{-t}(1-c) + e^{-2t}(2c-1) = 0$ giving $e^{-t} = \frac{1-c}{1-2c}$. Since the solution for e^{-t} must lie between zero and unity it requires $c > 1$. The overshoot will be $e^{-2t}(1-2c) - 2e^{-t}(1-c) = \frac{(c-1)^2}{(2c-1)}$. Thus for the values of c equal to 0.5, 1, 1.5 and 2, the overshoots will be 0, 0, 12.5% and 33%. Figure 3.2 shows the responses from Matlab. To get multiple plots on the same graph the 'hold' facility can be used in Matlab.

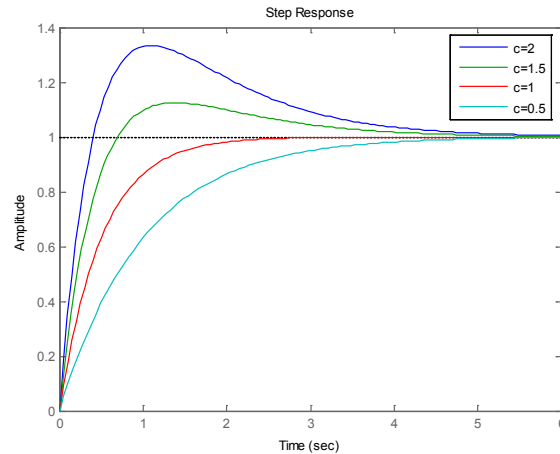

Figure 3.2 Step responses for the transfer function of example 3.4.

The peak value of the response can be obtained in Matlab as shown below for $c = 1.5$

```
y=step([3 2],[1 3 2]);
```

```
>> max(y)
```

```
ans =
```

```
1.1250
```



Develop the tools we need for Life Science
Masters Degree in Bioinformatics

Bioinformatics is the exciting field where biology, computer science, and mathematics meet.

We solve problems from biology and medicine using methods and tools from computer science and mathematics.

Read more about this and our other international masters degree programmes at www.uu.se/master



Example 3.5

A pulse, $x(t)$, defined by $x(t) = 1$ for $t < \Delta$ and $x(t) = 0$ for $t > \Delta$, is applied to the transfer function $G(s) = 1/(s+1)$ obtain the output response. If the height of the pulse is changed to $1/\Delta$ so that it has unit area, show that by taking the limit as $\Delta \rightarrow 0$ one obtains the impulse response $g(t)$ of $G(s)$.

A quick appraisal of the situation indicates that the input is the sum of two unit steps a positive one occurring at time zero and a negative one at time Δ . Thus using superposition the response will be that for the unit positive step from time zero to Δ and for $t > \Delta$ the sum of the unit positive step response and that of a negative step at time $t = \Delta$. Since the unit step response of the transfer function is $1 - e^{-t}$ the response $y(t)$ will be $1 - e^{-t}$ for $0 < t \leq \Delta$ and $1 - e^{-t} - 1 + e^{-(t-\Delta)} = e^{-(t-\Delta)} - e^{-t}$ for $t > \Delta$. Note that for the response to the negative step since it occurs at time $t = \Delta$ the time variable is shifted to $t - \Delta$. There are other ways of writing this result, since by definition of the unit step $u(t)$ is unity for $t > 0$ and zero for $t < 0$, so that $u(t - \tau)$ is unity for $t > \tau$ and zero for $t < \tau$. Thus one can write $y(t) = u(t)[1 - e^{-t}] - u(t - \Delta)[1 - e^{-(t-\Delta)}]$ or $y(t) = 1 - e^{-t} - u(t - \Delta)[1 - e^{-(t-\Delta)}]$ both of which are valid for all $t > 0$.

The alternative approach which is more logical, certainly for more complicated input functions, is to note that the input is $u(t) - u(t - \Delta)$ which has the Laplace transform $\frac{1}{s} - \frac{e^{-\Delta s}}{s}$. The output is therefore the inverse Laplace transform of $[\frac{1}{s} - \frac{e^{-\Delta s}}{s}][\frac{1}{s+1}]$ which gives as before $y(t) = u(t)[1 - e^{-t}] - u(t - \Delta)[1 - e^{-(t-\Delta)}]$.

When the pulse has unit area then for $t > \Delta$, $y(t) = (1/\Delta)\{u(t)[1 - e^{-t}] - u(t - \Delta)[1 - e^{-(t-\Delta)}]\}$, which as $\Delta \rightarrow 0$ becomes $y(t) = \lim_{\Delta \rightarrow 0} (1/\Delta)\{-e^{-t} + e^{-(t-\Delta)}\} = \lim_{\Delta \rightarrow 0} (1/\Delta)\{e^{-t}(e^{\Delta} - 1)\} = e^{-t} = g(t)$

Comment

Here the unit pulse function $p_{\Delta}(t) = u(t) - u(t - \Delta)$ between zero and Δ has been used which is very useful for taking the Laplace transform of piecewise continuous functions. Note that if this is time shifted to start at $t = \tau$, that is $p_{\Delta\tau}(t - \tau) = u(t - \tau) - u(t - \tau - \Delta)$, then the function $f(t)p_{\Delta\tau}(t - \tau)$ is zero everywhere except between $t = \tau$ and $t = \tau + \Delta$ where it is equal to $f(t)$.

Example 3.6

Determine the Laplace transforms of the following signals, $x(t)$:-

- $x(t) = \sin \omega t$ for $t \leq 2\pi / \omega$ and zero elsewhere.
- $x(t) = t$ for $0 \leq t \leq 1$ and $x(t) = 1$ for $t > 1$
- $x(t) = t^2 u(t - \tau)$

- The signal is equal to $(\sin \omega t)p_{2\pi/\omega}(t)$ so its Laplace transform is _____ - _____

b) The signal is equal to $\frac{1}{s^2} - \frac{e^{-s}}{s^2} + \frac{e^{-s}}{s}$. Note the signal $x(t)$ can also be described as the summation of the two signals t from 0 to ∞ , $-t + 1$ from 1 to ∞ which can be seen to give the same Laplace transform.

c) The signal $x(t) = t^2 u(t - \tau)$ can be written in the form

when expanding the t^2 term. Each term is now in the form $f(t - \tau)u(t - \tau)$ so the Laplace transform is $\frac{2e^{-s\tau}}{s^3} + \frac{2e^{-s\tau}}{s^2} + \frac{\tau^2 e^{-s\tau}}{s}$.

Example 3.7

The second order underdamped transfer function $G(s) = \frac{\omega_o^2}{s^2 + 2\zeta s \omega_o + \omega_o^2}$ has an input consisting of a step of magnitude a at time zero and another of magnitude $1 - a$ at time τ . Find the output and show that if τ is taken equal to $\pi / \omega_o (1 - \zeta^2)^{1/2}$ and $\cos \varphi = \zeta$ where $\varphi = \tan^{-1} \frac{\zeta \omega_o}{\omega_o (1 - \zeta^2)^{1/2}}$ then the output will be unity for $t > \tau$.

The input signal is $Y(s) = \frac{a}{s} + \frac{(1-a)e^{-s\tau}}{s}$. The step response, $y(t)$, of $G(s)$ is given in many books but it will be worked out here. One has $Y(s) = \frac{\omega_o^2}{s(s^2 + 2\zeta s \omega_o + \omega_o^2)} = \frac{1}{s} + \frac{s + 2\zeta \omega_o}{s^2 + 2\zeta s \omega_o + \omega_o^2}$ and taking the inverse Laplace transform gives

where $\omega = \omega_o (1 - \zeta^2)^{1/2}$ and $\cos \varphi = \zeta$. From differentiation of $y(t)$ to find its maximum yields $\tan(\omega t + \varphi) = \tan \varphi$, so that $t = n\pi / \omega$.

The first overshoot occurs for $t = \pi / \omega$, which on substituting in the solution for $y(t)$ gives $y(t) = 1 + \exp[-\zeta \pi / (1 - \zeta^2)^{1/2}] = 1 + \Delta$, where Δ is the per unit overshoot. Thus the response, $c(t)$ to the given input is

$$c(t) = a - \frac{a \exp(-\zeta \omega_o t)}{(1 - \zeta^2)^{1/2}} \sin(\omega t + \varphi) + (1 - a)u(t - \tau) \left[1 - \frac{\exp[-\zeta \omega_o (t - \tau)]}{(1 - \zeta^2)^{1/2}} \sin[\omega(t - \tau) + \varphi] \right]$$

which for $t > \tau$ gives

$$c(t) = 1 - \frac{a \exp(-\zeta \omega_o t)}{(1 - \zeta^2)^{1/2}} \sin(\omega t + \varphi) - \frac{(1 - a) \exp[-\zeta \omega_o (t - \tau)]}{(1 - \zeta^2)^{1/2}} \sin[\omega(t - \tau) + \varphi]$$

that is

$$c(t) = 1 - \frac{\exp(-\zeta \omega_o t)}{(1 - \zeta^2)^{1/2}} [a \sin(\omega t + \varphi) + (1 - a) \exp(\zeta \omega_o \tau) \sin(\omega t + \varphi - \omega \tau)]$$

Now if $\tau = \pi / \omega_o (1 - \zeta^2)^{1/2} = \pi / \omega$ then

$$c(t) = 1 - \frac{\exp(-\zeta\omega_o t)}{(1 - \zeta^2)^{1/2}} \{a \sin(\omega t + \varphi) + (1 - a) \exp[-\zeta\pi / (1 - \zeta^2)] \sin(\omega t + \varphi - \pi)\}$$

The term within the brackets is

$a \sin(\omega t + \varphi) + (1 - a) \exp[-\zeta\pi / (1 - \zeta^2)] \sin(\omega t + \varphi - \pi) = \sin(\omega t + \varphi) [a - \Delta^{-1}(1 - a)]$ which is zero for $a\Delta = (1 - a)$, that is $a = 1 / (1 + \Delta)$. Thus $c(t) = 1$ for $t > \tau$ if $\tau = \pi / \omega_o (1 - \zeta^2)^{1/2}$ and $a = 1 / (1 + \Delta)$, as required.

UNIVERSITY OF COPENHAGEN



Copenhagen Master of Excellence

Copenhagen Master of Excellence are two-year master degrees taught in English at one of Europe's leading universities

Come to Copenhagen - *and aspire!*

Apply now at
www.come.ku.dk



cultural studies

religious studies

science

Comment

There is a nice physical explanation for this result. Consider a load suspended vertically on a rod for which the anchor point is free to move horizontally in the x direction and it is moved instantaneously a distance a . Then the load will start to move to below the anchor point. If the motion is described by the second order differential equation corresponding to the above transfer function it will overshoot. When it reaches its overshoot, where its velocity will be zero, if the anchor point is then moved instantaneously to be directly above it, which will be a further distance $a\Delta$, then the motion will stop. This concept was originally due to Smith [3.1] and called posicast control. More recently the general approach where the input form is adjusted to produce a desired output, has become known as input shaping and has received considerable attention in recent years in the control engineering literature.

Example 3.8

The sinusoidal signal $\sin(\omega t + \theta)$ is applied to a network with transfer function $1/(1 + sT)$ at time $t = 0$. Find the output. What should be the value of θ for no transient to be observed in the output?

This is a simple example to illustrate the fact that when applying a sinusoidal signal to any dynamic system the steady state sinusoidal output which gives the frequency response is only attained after a transient has decayed.

First the Laplace transform of $\sin(\omega t + \theta)$ is required. It can be seen from 3 in Table 1 that with $\zeta = 0$ the Laplace transform of $\sin \omega t$ is $\frac{\omega}{s^2 + \omega^2}$ so that by differentiation the Laplace transform of $\omega \cos \omega t$ is $\frac{s\omega}{s^2 + \omega^2}$ giving the Laplace transform of $\cos \omega t$ as $\frac{s}{s^2 + \omega^2}$, or the result can be obtained directly from 4 with $\zeta = 0$. Thus the Laplace transform of $\sin(\omega t + \theta)$ which equals $\sin \omega t \cos \theta + \cos \omega t \sin \theta$ is $\frac{\omega \cos \theta + s \sin \theta}{s^2 + \omega^2}$.

Therefore the output $Y(s)$ from the transfer function is given by $\left\{ \frac{\omega \cos \theta + s \sin \theta}{s^2 + \omega^2} \right\} \left\{ \frac{1}{1 + sT} \right\}$.

Putting into partial fractions as $\frac{A}{1 + sT} + \frac{Bs + C}{s^2 + \omega^2}$ yields $A = \frac{\omega T^2 \cos \theta - T \sin \theta}{1 + \omega^2 T^2}$,

$B = \frac{\sin \theta - \omega T \cos \theta}{1 + \omega^2 T^2}$ and $C = \frac{\omega^2 T \sin \theta + \omega \cos \theta}{1 + \omega^2 T^2}$. Inverting the partial fraction expansion gives

$Ae^{-t/T} + B \cos \omega t + (C/\omega) \sin \omega t$ which on substituting for A , B and C , and after some algebra gives the solution for the output, $y(t)$, of

$$y(t) = \left\{ \frac{\omega T^2 \cos \theta - T \sin \theta}{1 + \omega^2 T^2} \right\} e^{-t/T} + \frac{1}{(1 + \omega^2 T^2)^{1/2}} \sin(\omega t + \phi)$$

where $\phi = \theta - \tan^{-1} \omega T$. The first term is the transient term which essentially becomes zero after $5T$ and the second term is the steady state sinusoidal output signal. Note as expected its amplitude is $1(1 + \omega^2 T^2)^{1/2}$ and it lags the input by $\tan^{-1} \omega T$ as is obtained by putting $s = j\omega$ into the transfer function. For the transient term to be zero requires $\omega T^2 \cos \theta - T \sin \theta = 0$ so that $\tan \theta = \omega T$. This is as expected since the output starts from zero and must therefore be $\sin \omega t$ with no transient, which is confirmed by the steady state term in the solution as $\phi = 0$.

References

3.1 Smith O.J.M. Feedback Control Systems. McGraw-Hill, New York, 1958.

3.3 Problems

Problem 3.1

Find the unit step response of the transfer function $G(s) = \frac{s^2 + 6s + 8}{s^2 + 4s + 3}$.

$$[(8/3) - (3/2)e^{-t} - (1/6)e^{-3t}]$$

Problem 3.2

Find the unit impulse response of the transfer function $G(s) = \frac{s+1}{(s+2)^2(s+3)}$.

$$[2e^{-2t} - 2e^{-3t} - te^{-2t}]$$

Problem 3.3

Find the unit impulse and unit step response of the transfer function $G(s) = \frac{1 - e^{-s}}{(s+2)^2}$.

$$[0.25 - 0.25e^{-2t} - 0.5te^{-2t} - \{0.25 - 0.25e^{-2(t-1)} - 0.5(t-1)e^{-2(t-1)}\}u(t-1)]$$

Problem 3.4

Find the unit impulse response of the transfer function $G(s) = \frac{1}{s^2 + 2s + 5}$. Use the result to obtain the unit impulse response of the transfer function $G(s) = \frac{s-3}{s^2 + 2s + 5}$.

$$[0.5e^{-t} \sin 2t; e^{-t} \cos 2t - 2e^{-t} \sin 2t]$$

Problem 3.5

Find the unit step response of the transfer function $G(s) = \frac{5}{s^2 + 2s + 5}$. What is the final value of the output? Check this result by using the final value theorem.

$$[1 - e^{-t} \cos 2t - 0.5e^{-t} \sin 2t; 1]$$

Problem 3.6

What is the maximum overshoot for the step response of Problem 3.5. Check the result using Matlab

[20.8%, or .208 per unit{ $e^{-\pi/2}$ }]

Problem 3.7

Find the unit step response of the transfer $G(s) = \frac{e^{-2s}}{(s+1)^2(s+2)}$ function.

$[0.5 - (t-2)e^{-(t-2)} - 0.5e^{-2(t-2)}]u(t-2)$

Problem 3.8

Use Matlab to obtain the partial fraction expansion $G(s) = \frac{s+2}{s^4+6s^3+10s^2+9s+4}$, and hence determine its impulse response.

[p = 0.0513 0.3333 -0.1923 - 0.1999i -0.1923 + 0.1999i

r = -4.0000 -1.0000 -0.5000 + 0.8660i -0.5000 - 0.8660i

$0.0513e^{-4t} + 0.3333e^{-t} + e^{-0.5t} \{-0.288 \sin 0.866t - 0.385 \cos 0.866t\}$]



Brain power

By 2020, wind could provide one-tenth of our planet's electricity needs. Already today, SKF's innovative know-how is crucial to running a large proportion of the world's wind turbines.

Up to 25 % of the generating costs relate to maintenance. These can be reduced dramatically thanks to our systems for on-line condition monitoring and automatic lubrication. We help make it more economical to create cleaner, cheaper energy out of thin air.

By sharing our experience, expertise, and creativity, industries can boost performance beyond expectations. Therefore we need the best employees who can meet this challenge!

The Power of Knowledge Engineering

Plug into The Power of Knowledge Engineering.
Visit us at www.skf.com/knowledge

SKF

Problem 3.9

An R-C circuit has the input applied to the series combination and the output taken from across the capacitor. The input is $\sin(t+\phi)$, $R=1M\Omega$ and $C=1\mu F$. Find the value of ϕ so that there is no transient in the output. Check your answer using Simulink.

[45°]

Problem 3.10

Find using Matlab the smallest value of T for which the transfer function $G(s) = \frac{5}{(1+sT)(s^2+2s+5)}$ will not have an overshoot for a step input.

[0.81]

Problem 3.11

Find using Matlab the largest value of T for which the transfer function $G(s) = \frac{5(1+sT)}{(2s+1)(s^2+2s+5)}$ will not have an overshoot for a step input.

[1.45]

Problem 3.12

Find using Matlab the largest value of T for which the transfer function $G(s) = \frac{2(1+sT)}{(s+1)^2(s+2)}$ will not have an overshoot for a step input.

[≈ 1.2]

4 Frequency Responses and their Plotting

4.1 Introduction

The frequency response, or more correctly steady state frequency response, of a transfer function $G(s)$ is $G(j\omega)$. The topic is covered in chapter 4 of reference 1. Briefly $G(j\omega)$ is a complex number with a magnitude and argument (phase) so that if one wishes to show its behaviour over a frequency range then one has 3 parameters to deal with the frequency, ω , the magnitude, M , and the phase ϕ . Alternatively it can be written in terms of its real $X(j\omega)$ and imaginary $Y(j\omega)$ components. The former is the polar representation of a complex number and the latter the rectangular version. Students should become familiar with working with both the polar and rectangular forms as dependent on what is required one approach may prove superior. Engineers use three common ways to plot the information, which are known as Bode diagrams, Nyquist diagrams and Nichols diagrams as discussed in chapter 4 of reference 1.

The examples in this section deal with frequency responses and their plotting and again have been chosen to try and illustrate important points.

4.2 Examples

Example 4.1

A network has a transfer function of $G(s) = 1/(1 + sT)^n$. Calculate the frequency at which it will have a phase shift of -180° and the corresponding gain. What are the values for $n = 3$ and 6. Check the result for $n = 3$ using Matlab and explain how you have obtained the result.

This example is chosen to illustrate a situation where the best approach is to work in the polar form (i.e. gain and phase). Here

$$|G(j\omega)| = \frac{1}{(1 + \omega^2 T^2)^{n/2}} \quad \text{and} \quad \text{Arg}G(j\omega) = n \tan^{-1}(\omega T).$$

Thus the phase is -180° when $n \tan^{-1}(\omega T) = \pi$, which gives $\omega T = \tan(\pi/n)$ and a corresponding gain of $|G(j\omega)| = \frac{1}{[1 + \tan^2(\pi/n)]^{n/2}}$.

In particular for $n = 3$, $\omega T = \tan(\pi/3) = \sqrt{3}$ and $|G(j\omega)| = \frac{1}{(1+3)^{3/2}} = \frac{1}{8} = 0.125$; and for $n = 6$, $\omega T = \tan(\pi/6) = 1/\sqrt{3}$ and $|G(j\omega)| = \frac{1}{(1+\frac{1}{3})^{3/2}} = \frac{3\sqrt{3}}{8} = 0.650$.

The commands to get the Nyquist plot in Matlab for $n = 3$ are

```
>>G=tf(1,[1 3 3 1]);
```

```
>> nyquist(G)
```

The plot is shown in Figure 4.1 and is drawn for both positive and negative frequencies, ω . The arrows mark the direction of increasing ω and the plot for negative ω is the mirror image in the real axis of that for positive ω . Or stated alternatively, the expression for a Nyquist plot has a real part which is an even function of ω and an imaginary part which is an odd function of ω . (See Example 4.2)

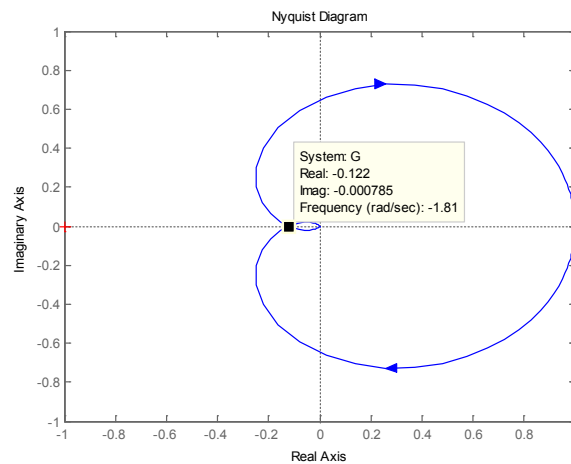

Figure 4.1 Nyquist plot for example 4.1

Trust and responsibility

NNE and Pharmaplan have joined forces to create NNE Pharmaplan, the world's leading engineering and consultancy company focused entirely on the pharma and biotech industries.

Inés Aréizaga Esteva (Spain), 25 years old
Education: Chemical Engineer

– You have to be proactive and open-minded as a newcomer and make it clear to your colleagues what you are able to cope. The pharmaceutical field is new to me. But busy as they are, most of my colleagues find the time to teach me, and they also trust me. Even though it was a bit hard at first, I can feel over time that I am beginning to be taken seriously and that my contribution is appreciated.

NNE Pharmaplan is the world's leading engineering and consultancy company focused entirely on the pharma and biotech industries. We employ more than 1500 people worldwide and offer global reach and local knowledge along with our all-encompassing list of services.
nnepharmaplan.com

nne pharmaplan®

To find the gain and frequency when the phase is -180° the cursor can be used as shown in Figure 4.1 to obtain an approximate result or the command margin(G), which gives 18.1dB (this corresponds to -0.125) at a frequency of 1.73 rads/s. (See Example 5.2 for a further explanation).

Example 4.2

Prove that the frequency response of a transfer function $G(s)$ has a real part which is even in ω and an imaginary part which is odd in ω .

It will be assumed that the transfer function does not have a time delay, although if this may not be

the case the result is still easily shown to be true. Let $G(s) = \frac{B(s)}{A(s)}$ thus $G(j\omega) = \frac{B(j\omega)}{A(j\omega)}$ which can be

written $G(j\omega) = \frac{C(\omega^2) + j\omega D(\omega^2)}{E(\omega^2) + j\omega F(\omega^2)} = \frac{\{C(\omega^2) + j\omega D(\omega^2)\} \{E(\omega^2) - j\omega F(\omega^2)\}}{E^2(\omega^2) + \omega^2 F^2(\omega^2)}$ which can be written

$G(j\omega) = \frac{CE + \omega^2 DF + j\omega\{DE - CF\}}{E^2 + \omega^2 F^2}$ where the dependence of the polynomials C, D, E, and F on ω^2

has been omitted. Thus $\text{Re}\{G(j\omega)\} = \frac{CE + \omega^2 DF}{E^2 + \omega^2 F^2}$ which is even and $\text{Im}\{G(j\omega)\} = \frac{\omega(DE - CF)}{E^2 + \omega^2 F^2}$ which

is odd.

Example 4.3

Show that the phase lead network $G(s) = \frac{1+sT}{1+s\alpha T}$ where $\alpha < 1$ has a maximum phase lead of $\sin^{-1} \frac{1-\alpha}{1+\alpha}$ at the angular frequency of $\omega_m = \frac{1}{T\sqrt{\alpha}}$ and that the corresponding gain in dB is $-10 \log_{10} \alpha$. [Quoted without proof in chapter 7 of reference 1].

Here $G(j\omega) = \frac{1+j\omega T}{1+j\omega\alpha T}$ and to simplify the algebra we let $u = \omega T$ so that the phase lead is

$\tan^{-1} u - \tan^{-1} \alpha u = \tan^{-1} \frac{u - \alpha u}{1 + \alpha u^2}$. Here the very useful relationship for arc tangent functions, namely

$\tan^{-1} A \pm \tan^{-1} B = \tan^{-1} \frac{A \pm B}{1 \mp AB}$ has been used. Differentiating the expression $X = \frac{u - \alpha u}{1 + \alpha u^2}$ with respect to u

and equating to zero gives $u(1-\alpha)2\alpha u = (1-\alpha)(1+\alpha u^2)$ giving $\alpha u^2 = 1$, that is $\omega = 1/T\sqrt{\alpha}$. Thus the

maximum phase lead is $\tan^{-1} 1/\sqrt{\alpha} - \tan^{-1} \sqrt{\alpha} = \tan^{-1} \frac{1-\alpha}{2\sqrt{\alpha}} = \sin^{-1} \frac{1-\alpha}{1+\alpha}$ and the gain is $\frac{(1+u^2)^{1/2}}{(1+\alpha^2 u^2)^{1/2}}$

which with $u = 1/\sqrt{\alpha}$ substituted becomes $1/\sqrt{\alpha}$, that is $-10 \log_{10} \alpha$ in dB.

Example 4.4

Sketch the Bode and Nyquist diagrams for the transfer function $G(s) = \frac{1-2s}{s(1+s)}$ and check the results using Matlab.

For the Bode diagram the transfer function is considered as the individual terms:-

- 1) $1 - 2s$ for the rhs plane zero, which in terms of asymptote sketching rises at +6dB/octave from a break point at 0.5rad/s. The phase varies from 0° to -90° .
- 2) $\frac{1}{s}$ for the integrator, a line of slope -6dB/octave with 0dB gain at 1 rad/s. A constant phase of -90°
- 3) $\frac{1}{1+s}$ for the lhs plane pole, which has a slope of -6dB/octave from the break point at 1 rad/s. The phase varies from 0° to -90° .

The three individual Bode plots are shown in Figure 4.2, as 1, 2 and 3 respectively together with that for their 'sum' $G(s)$ as 4. Note that the phase curve cannot be estimated from the magnitude curve as the transfer function is not minimum phase, {i.e. the final slope is -6db/octave (or -20dB/decade) but the phase is -270° }.

Information from the Bode diagram can, of course, be used to assist in sketching the Nyquist plot, but if the former is not required the following points can easily be seen by considering the individual elements in $G(s)$ as done in the Bode diagram or directly from $G(j\omega)$, from which it can be seen that:-

- 1) At low frequencies the phase shift tends to -90° and the magnitude to infinity
- 2) At high frequency the phase tends to -270° and the gain to zero.
- 3) From low frequencies to high frequencies the phase varies continuously from -90° to -270° and the gain reduces continuously. At some frequency the phase must be -180° .

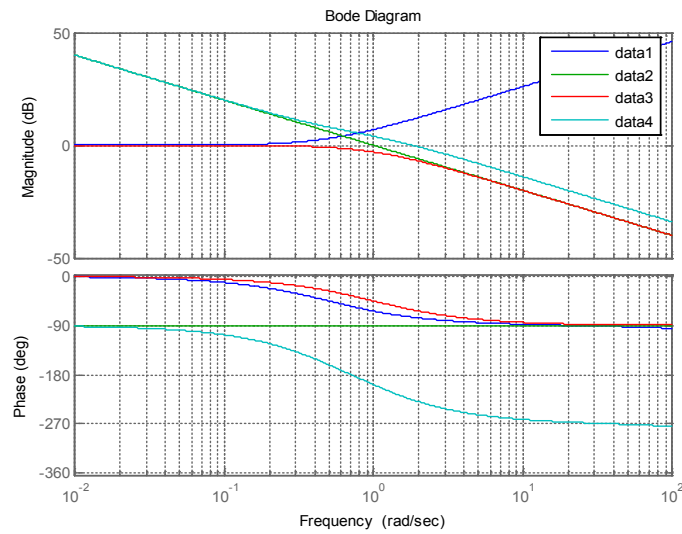

Figure 4.2 Bode diagram for $G(s)$ of example 4.4.

This e-book
is made with
SetaPDF



PDF components for PHP developers

www.setasign.com



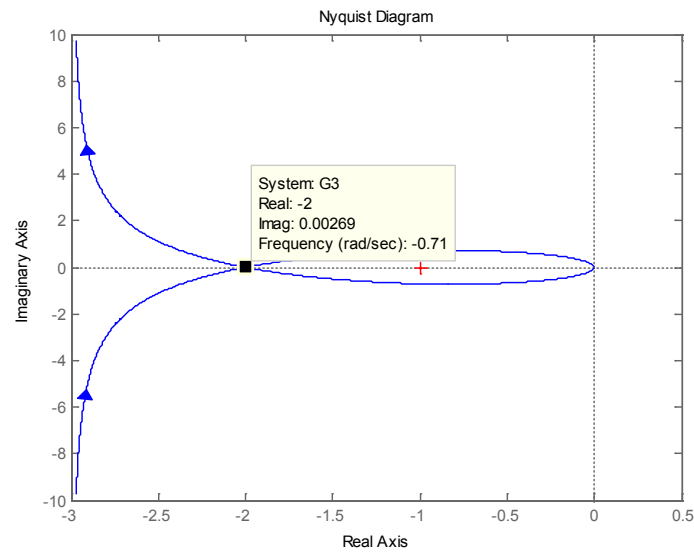

Figure 4.3 Nyquist plot for $G(s)$ of example 4.4

To obtain further information on the Nyquist plot requires some calculations. Points of interest are obviously where the phase is -180° and the low frequency asymptote, which is not necessarily the negative imaginary axis as many sketches in books often seem to indicate. From phase considerations the argument of $G(j\omega)$ is $-\tan^{-1} 2\omega - 90^\circ - \tan^{-1} \omega$. This is -180° where $\tan^{-1} 2\omega + \tan^{-1} \omega = \tan^{-1} \frac{3\omega}{1 - 2\omega^2} = 90^\circ$, which gives $\omega = \sqrt{1/2} = 0.707$. The corresponding gain is $\frac{(1+2)^{1/2}}{\sqrt{1/2}(1+1/2)^{1/2}} = 2$, which are in agreement with the Nyquist plot shown in Figure 4.3. Writing $G(j\omega) = \frac{1-2j\omega}{j\omega(1+j\omega)} = \frac{(1-2j\omega)(1-j\omega)}{j\omega(1+\omega^2)}$ in rectangular form $X(\omega) + jY(\omega)$ gives $X(j\omega) = \frac{-3}{(1+\omega^2)}$ which tends to -3 as ω tends to zero.

Note that since the Nyquist plot goes to infinity at zero frequency the infinite semicircle closure at this frequency given by the theory is not shown as may be required for stability assessment. (See Example 5.4). Although this can be found theoretically it can also be found using Matlab by replacing the integrator by a 'lossy integrator', that is $\frac{1}{s}$ by $\frac{1}{s + \varepsilon}$ where ε is small. The Nyquist plot is shown in Figure 4.4 with $\varepsilon = 0.05$.

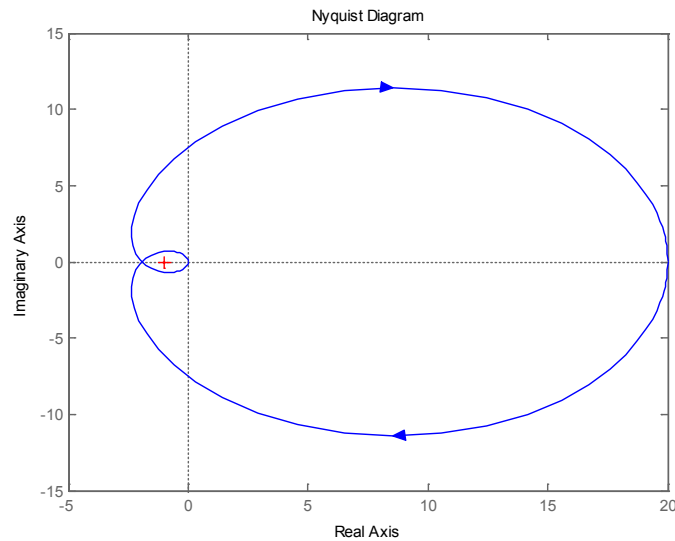

Figure 4.4 Nyquist plot for example 4 with 'lossy integrator'.

Example 4.5

Find for the transfer function $G(s) = \frac{\omega_o^2}{s(s^2 + 2\zeta\omega_o s + \omega_o^2)}$ the frequency at which it has a phase shift of -180° and the corresponding gain. Check the result using Matlab for $\omega_o = 4$ and $\zeta = 0.2$.

The given transfer function $G(j\omega) = \frac{\omega_o^2}{j\omega(-\omega^2 + 2\zeta\omega_o j\omega + \omega_o^2)}$ may be considered as an integrator $1/s$ in series with an underdamped second order system. The integrator gives a phase of -90° at all frequencies so the phase shift of the two in series will be -180° when the second order underdamped transfer function has a phase shift of -90° . This can easily be seen to be the case when $\omega = \omega_o$ and its response will be $-1/2\zeta j$ (see also Figure 4.2 reference 1 for the frequency response of the second order transfer function). Thus the gain of the transfer function at the frequency $\omega = \omega_o$ is $1/2\zeta\omega_o$. For $\omega_o = 4$ and $\zeta = 0.1$ the gain is $1.25 = 1.94$ dB at 4 rads/s, which is confirmed to cursor accuracy, by the Bode plot of Figure 4.5.

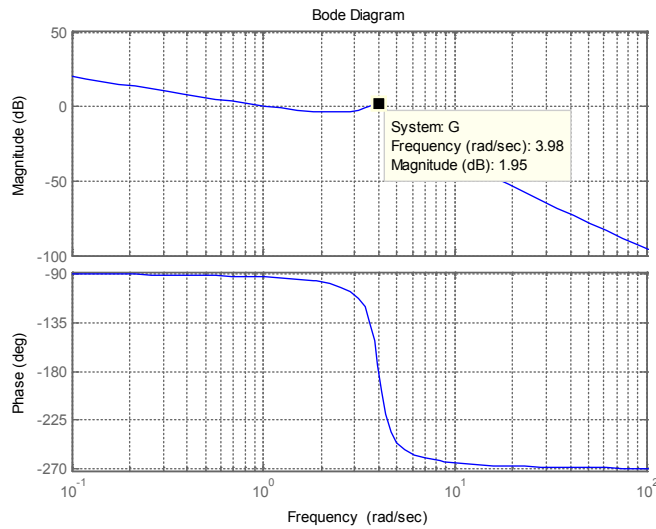

Figure 4.5 Bode plot for example 4.5

Example 4.6

Determine the low frequency asymptote for the Nyquist plot of $G(s) = \frac{1 + sT_1}{s(1 + sT_2)(1 + sT_3)}$

What should be the relationship between the time constants if the asymptote is to be the imaginary axis?



Sharp Minds - Bright Ideas!

Employees at FOSS Analytical A/S are living proof of the company value - First - using new inventions to make dedicated solutions for our customers. With sharp minds and cross functional teamwork, we constantly strive to develop new unique products - Would you like to join our team?

FOSS works diligently with innovation and development as basis for its growth. It is reflected in the fact that more than 200 of the 1200 employees in FOSS work with Research & Development in Scandinavia and USA. Engineers at FOSS work in production, development and marketing, within a wide range of different fields, i.e. Chemistry, Electronics, Mechanics, Software, Optics, Microbiology, Chemometrics.

We offer
A challenging job in an international and innovative company that is leading in its field. You will get the opportunity to work with the most advanced technology together with highly skilled colleagues.

Read more about FOSS at www.foss.dk - or go directly to our student site www.foss.dk/sharpminds where you can learn more about your possibilities of working together with us on projects, your thesis etc.

Dedicated Analytical Solutions

FOSS
 Slangerupgade 69
 3400 Hillerød
 Tel. +45 70103370
www.foss.dk





For this example it is noted that at low frequencies the gain tends to infinity at a phase of -90° and at high frequencies the gain tends to zero and the phase to -180° . The low frequency phase of -90° does not necessarily mean that the locus at zero frequency finishes on the negative imaginary axis as it may tend to an asymptote other than the imaginary axis. Often this is not clearly shown in sketches of Nyquist plots given in some textbooks. To solve this example one needs to work in rectangular coordinates. Thus
$$G(j\omega) = \frac{1 + j\omega T_1}{j\omega(1 + j\omega T_2)(1 + j\omega T_3)} = \frac{(1 + j\omega T_1)(1 - j\omega T_2)(1 - j\omega T_3)}{j\omega(1 + \omega^2 T_2^2)(1 + \omega^2 T_3^2)}$$
 giving
$$\text{Re}G(j\omega) = \frac{-\omega^2 T_1 T_2 T_3 + (T_1 - T_2 - T_3)}{(1 + \omega^2 T_2^2)(1 + \omega^2 T_3^2)}$$
. Hence as the frequency tends to zero the real part of the locus tends to the value $T_1 - T_2 - T_3$. In particular if $T_1 = 3$ and $T_2 = 1$, then for the three values of 1, 2 and 3 for T_3 the asymptote is at 1, 0 and -1 as shown in the Nyquist plots for positive frequencies only shown in Figure 4.6. For the imaginary axis to be the asymptote $T_1 = T_2 + T_3$.

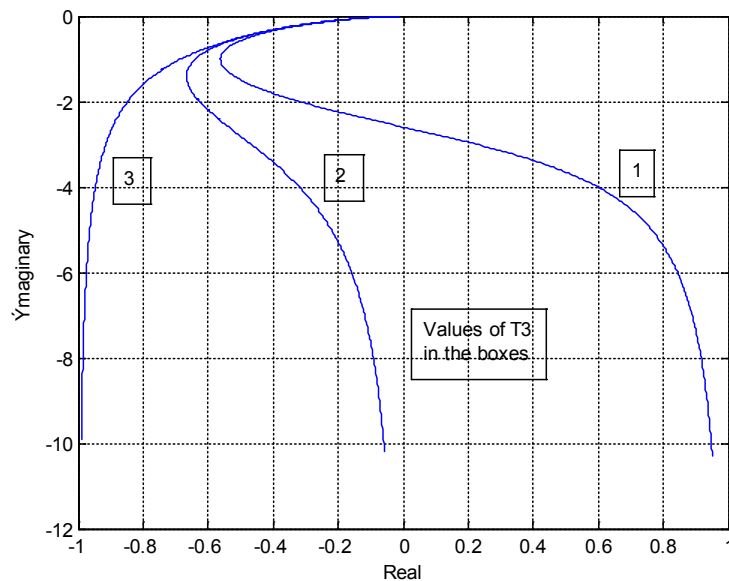

Figure 4.6 Nyquist plots for positive frequencies for different values of T_3 .

Example 4.7

Sketch the Bode and Nyquist diagrams for the transfer function
$$G(s) = \frac{s^2 + 2s + 16}{s(s-1)(s+1)}$$
.

First, for the Bode diagram, it is best to write the transfer function in the form
$$G(s) = \frac{-(s^2 + 2s + 16)}{s(1-s)(1+s)}$$
. The transfer function is seen to consist of the five components:-

- 1) A second order numerator term with a natural frequency of 4 and damping ratio of 0.25 with an asymptotic approximation of an increasing gain at 12dB/octave from $\omega = 4$ and phase from 0 to 180°.
- 2) An integrator, constant slope of -6dB/octave with 0dB at $\omega = 1$ and phase of -90°.
- 3) A time constant term corresponding to a pole at 1. Break point at $\omega = 1$ and decreasing gain. Phase shift from from 0° to 90°.
- 4) A time constant term corresponding to a pole at -1. Break point at $\omega = 1$ and decreasing gain. Phase shift from from 0° to -90°.
- 5) A gain of -1, that is a magnitude of 1 and a phase shift of -180°.

Thus in terms of an asymptotic plot the initial gain decreases with increase in frequency at -6dB/octave (due to 2) until $\omega = 1$, where it changes to -18dB/octave (due to 3 and 4), and then at $\omega = 4$ it returns to -6dB/octave (due to 1). The phase starts at -270° (-90° from 2 and -180° from 5}, at $\omega = 1$ it does not change (due to 3 and 4) and after $\omega = 4$ (due to 1) it eventually becomes -90°. The Bode plot is shown in Figure 4.7.

The Nyquist plot has infinite gain at low frequencies (due to 2) and a phase of -270° and at high frequencies goes to zero gain at a phase of -90°. It can be seen from the Bode plot that the gain decreases steadily, apart from between 4 and 8 rad/s where it is roughly constant. The phase changes continuously from low to high frequencies with a rapid variation around $\omega = 4$.

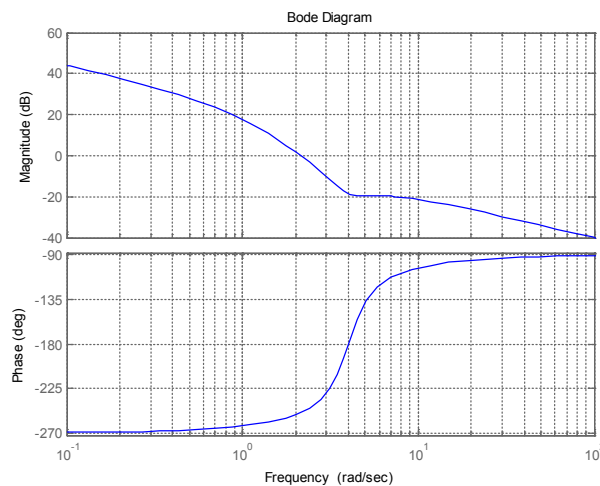

Figure 4.7 Bode diagram for example 4.7

Obvious other points of interest for the Nyquist plot are the asymptote at low frequencies and where the phase is -180°. The latter can be found easily since the phases of 3 and 4 cancel each other the phase shift will be -180° when the lead produced by 1 is 90°, which is at $\omega = 4$.

By calculation $G(j\omega) = \frac{-\omega^2 + 2j\omega + 16}{j\omega(j\omega - 1)(j\omega + 1)}$ which has a real part of $\frac{-2}{\omega^2 + 1}$ and therefore tends to -2 as the frequency tends to zero. The Nyquist plot is shown in Figure 4.8.

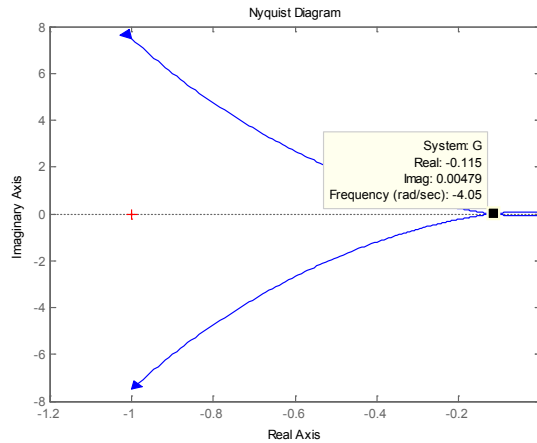

Figure 4.8 Nyquist plot for example 4.7.

In this case if the integrator is replaced by a 'lossy integrator' with $\varepsilon = 0.2$ (made quite large so that the original plot can also be seen) then the Nyquist plot is as shown in Figure 4.9. This indicates that the infinite semicircle for the Nyquist is in the left hand side of the diagram starting at -90° and going to 90° .

“I studied English for 16 years but...
...I finally learned to speak it in just six lessons”
Jane, Chinese architect

ENGLISH OUT THERE

Click to hear me talking before and after my unique course download

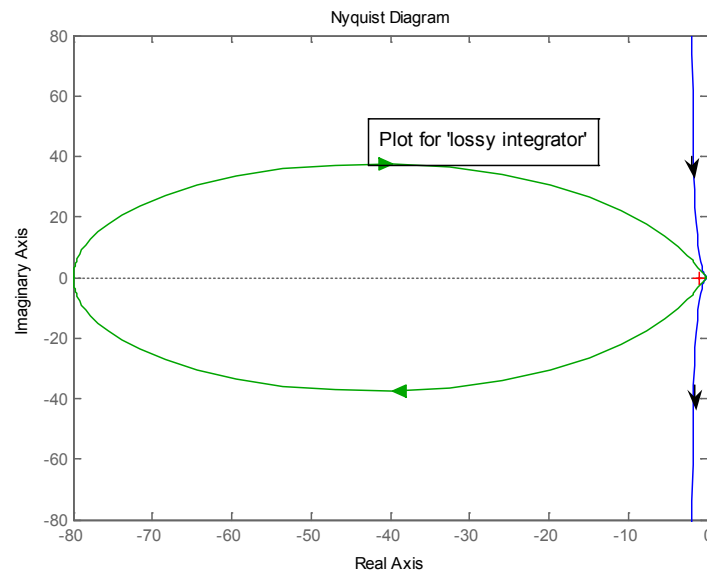

Figure 4.9 Nyquist plot with 'lossy integrator' for example 4.7

Example 4.8

Discuss the shape of the Nyquist diagram for $G(s) = \frac{0.70(s+1)(s^2+10s+1600)}{(s^2+0.5s+16)(s+70)}$ before plotting it with Matlab.

At zero frequency $G(0) = \frac{0.70 * 1 * 1600}{16 * 70} = 1$ and as the frequency, ω , tends to infinity $G(j\omega) = \frac{0.70(j\omega)^3}{(j\omega)^3} = 0.70$. Thus the locus starts at 1 and finishes at 0.7 on the real axis. In terms of increasing frequency there is a lead with breakpoint at 1rad/s, a pair of complex poles with resonant frequency at 4 rad/s and damping 0.0625, which is low, a pair of complex zeros with resonant frequency at 40 rads/s and damping 0.125 and finally a lag with break point at 70 rads/s. Thus one expects the Nyquist to show a lead initially with an increase in gain peaking around 4 rads/s. and increasing phase lag until the gain reaches almost zero at 40 rads/s. The Nyquist plot is shown in Figure 4.10 which clearly shows the peak gain around 4 rads/s. Figure 4.11 shows the plot for higher frequencies only, finishing at 0.7 on the real axis and going near to the origin at around 40 rads/s. The plot shows two intersections of the imaginary axis which could be calculated to obtain more detail for a sketch.

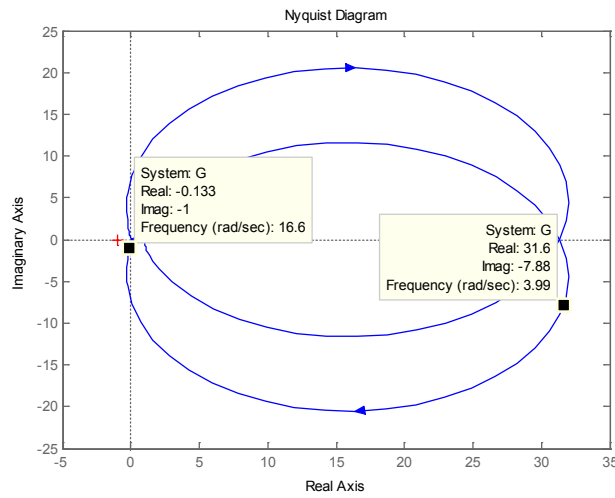

Figure 4.10 Nyquist plot for example 4.8

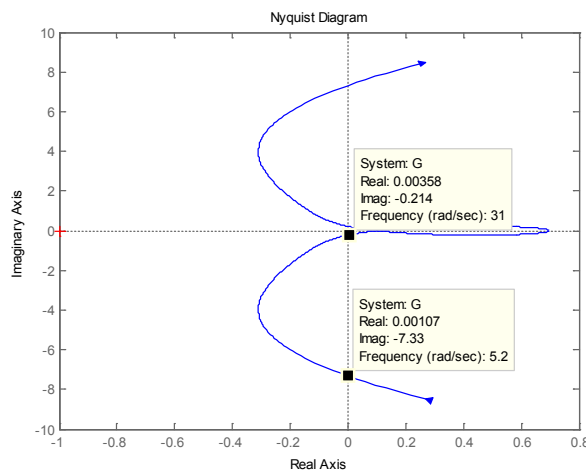

Figure 4.11 Nyquist plot at higher frequencies for example 4.8

4.3 Problems

Problem 4.1

A feedback system has an open loop transfer function $G(s) = 1/s(s + 1)^2$ and $H(s) = 1$. Obtain the Nyquist diagram for $G(j\omega)$ on a plot with M circles. From this estimate the peak of the closed loop frequency response and the frequency at which it occurs. Check the result by obtaining a Bode plot of the closed loop frequency response.

[$\approx 10\text{dB}$ (9.17dB), 0.73rads./s]

Problem 4.2

A compensator $G_c(s)$ of the form $G_c(s) = \frac{1+sT}{1+0.1s}$ is to be added before $G(s)$ in problem 3.1. Plot the Nyquist diagrams of $G_c(s)G(s)$ for various values of T and estimate the minimum value of T to ensure the maximum value in the closed loop frequency response does not exceed 3dB. Check the result on the closed loop Bode plot.

[0.73]

Problem 4.3

A feedback system has a plant transfer function of $G(s) = 4/(1+0.5s)(1+0.1s)^2$ and a feedback transfer function $H(s) = e^{-sT}$. Sketch the asymptotic Bode diagram for $G(s)$ and estimate the phase shift when the gain is unity and the frequency at which it occurs. Check your result using Matlab and determine the maximum value of T for the system to have a phase shift when the gain is unity of (i) -180° and (ii) -140° .

[-130°, 5.7rads/s; 0.153, 0.031]

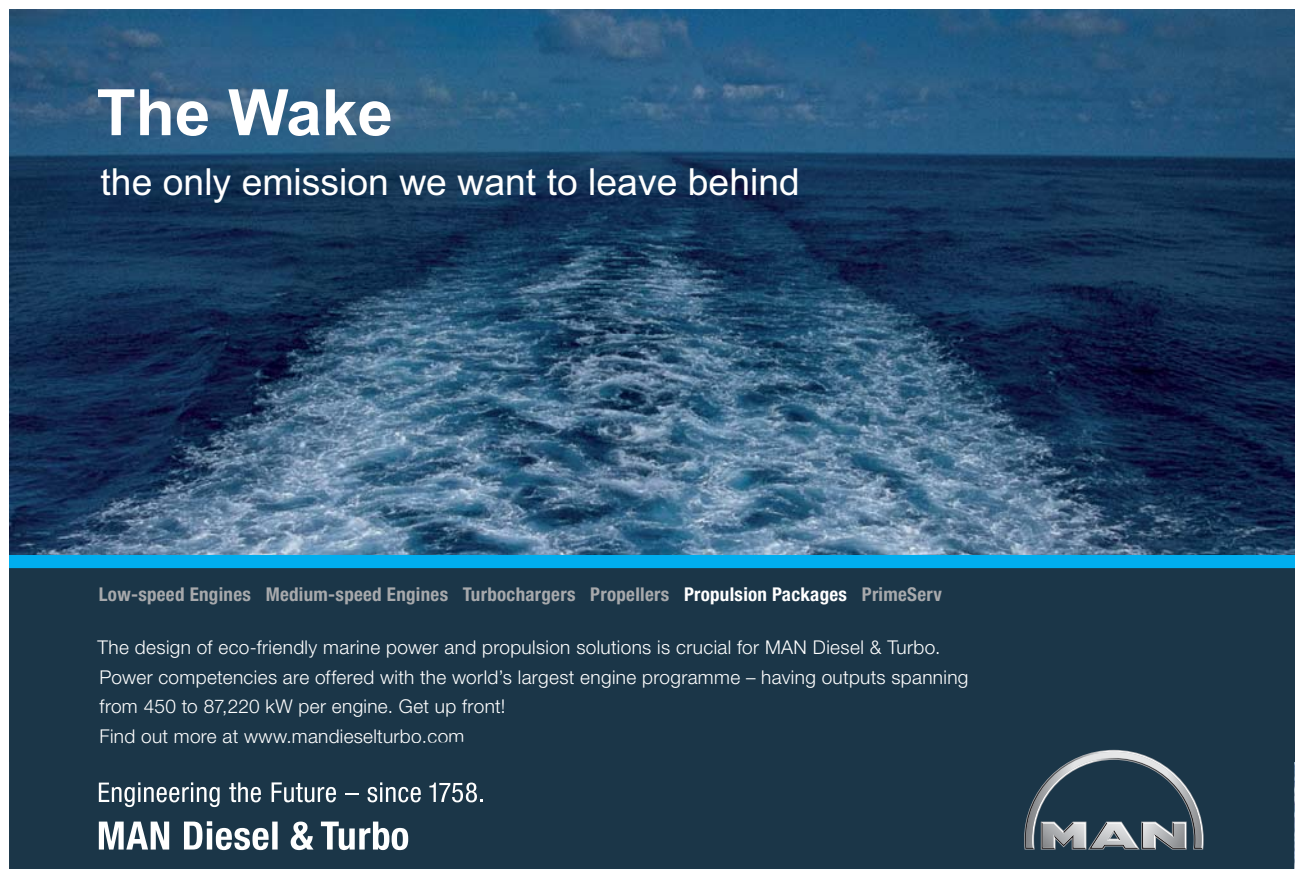

The Wake
the only emission we want to leave behind

Low-speed Engines Medium-speed Engines Turbochargers Propellers Propulsion Packages PrimeServ

The design of eco-friendly marine power and propulsion solutions is crucial for MAN Diesel & Turbo. Power competencies are offered with the world's largest engine programme – having outputs spanning from 450 to 87,220 kW per engine. Get up front!
Find out more at www.mandieselturbo.com

Engineering the Future – since 1758.
MAN Diesel & Turbo



Problem 4.4

Sketch the asymptotic Bode diagram for $G(s) = 0.5(1 + 4s) / s(1 + s + s^2)(1 + 0.5s)$ and estimate the phase shift when the gain is unity. Check your result using Matlab.

[-168.7°]

Problem 4.5

Sketch the asymptotic Bode diagram for $G(s) = (1 - s)(1 + 4s) / 8s(1 + 0.5s)^2$ and estimate the phase shift when the gain is unity and the gain when the phase is -180° . Sketch also the Nyquist diagram giving the frequency at which the real axis is crossed and the value of the asymptote as the frequency tends to zero. Check your results using Matlab.

[-76°, -5.71dB; 2.63, 0.25]

Problem 4.6

Sketch the Nyquist diagram for the transfer function $G(s) = \frac{(1 + s)^2}{s(1 + 0.1s)(s^2 - 4)}$. Calculate the frequency for which the phase is -180° and the value of the asymptote to which it tends for low frequencies.

[1.12, -0.475]

Problem 4.7

A unit negative feedback system has an open loop transfer function $G(s) = \frac{K(1 + s + s^2)}{s(1 + s)^3}$. Determine the maximum value of K if the closed loop frequency response should never exceed 0dB. Check the result using Matlab.

[0.25]

Problem 4.8

Sketch the Nyquist plot of $G(s) = \frac{s^2 + s + 4}{s(s - 1)(s + 1)}$ and evaluate any points at which the axes are cut and the corresponding frequencies. Determine also the infinite semicircle closure at $\omega = 0$.

[Real axis at -0.2 with $\omega = 2 \text{ rads} / s$; lhs plane from -90° to $+90^\circ$ as ω increases.]

5 Feedback Loop Stability

5.1 Introduction

The problems in this chapter are concerned with the determination of the stability and relative stability of a closed loop feedback system. This material is covered in reference 1 chapters 5 and 6, and a brief summary is given here.

If the open loop transfer function of the feedback loop, is denoted by $G(s)$ rather than $G_{ol}(s)$, then the closed loop transfer function, often denoted by $T(s)$, has a denominator of $1 + G(s)$. The loop will be stable if the roots of the denominator, namely the characteristic equation $1 + G(s) = F(s) = 0$, all have a negative real part, that is lie in the lhs s -plane. If $G(s)$ does not contain a time delay then $F(s)$ will be a polynomial in s with real coefficients f_n , that is $F(s) = f_0 + f_1s + f_2s^2 + \dots + f_ns^n$. Before the advent of modern computing facilities finding the roots of a polynomial of order greater than three was not an easy problem. A problem addressed during the 19th century by mathematicians was that of trying to find conditions for the roots of a polynomial to have negative real parts and this led to the well known Hurwitz-Routh criterion found in all control textbooks. For a polynomial with known coefficients the criterion provides a solution and symbolic results can be obtained for some low order polynomials. In particular it can be shown that a necessary but not sufficient condition (except for polynomials of order 1 and 2) is that all the coefficients, f_n , of the polynomial must be positive. For the third order polynomial a necessary and sufficient condition is all the coefficients must be positive and $f_1f_2 > f_0f_3$.

A graphical criterion due to Mikhailov states that if the polynomial $F(j\omega)$ is plotted for ω increasing from zero on a complex plane, then all its roots will lie in the lhs s -plane if from starting on the positive real axis at f_0 it moves in a counter clockwise direction passing successively through the positive imaginary axis, negative real axis etc in turn, cutting $n-1$ axes before tending to infinity.

The algorithm 'roots' given in Matlab now finds the roots of even quite high order polynomials very quickly and because of its speed can be used to assess how the roots vary with changes in the coefficients.

Control engineers are interested in finding the stability from the open loop transfer function $G(s)$. There are two reasons for this (i) the fact that the information available on the open loop may be the frequency response $G(j\omega)$ (particularly true several years ago when frequency response identification testing was common) and (ii) compensating networks are typically included inside the loop and thus their effect on the open loop transfer function is easily seen. The Nyquist criterion states that the closed loop system will be stable if the number of clockwise encirclements by the frequency response locus $G(j\omega)$ of the $(-1,0)$ point plus the number of rhs s -plane poles of $G(j\omega)$ is zero. The criterion can also be interpreted using Bode or Nichols plots.

The root locus is a method which shows how the roots of the characteristic equation vary with variations in a parameter, typically the open loop gain, K . One is often interested in 'how stable' a feedback loop is and typical measures of this, apart from the root locations provided by use of a root locus, are the gain and phase margin and the closed loop frequency response peak, which can be found from the open loop frequency response.

The examples covered in this section deal with the above topics.

5.2 Examples

Example 5.1

Consider a feedback loop with open loop transfer function $G(s) = \frac{K(s+1)}{s(s+a)(s^2+s+1)}$.

gaieteye
Challenge the way we run

EXPERIENCE THE POWER OF FULL ENGAGEMENT...

**RUN FASTER.
RUN LONGER..
RUN EASIER...**

**READ MORE & PRE-ORDER TODAY
WWW.GAITEYE.COM**

a) Consider initially the case of $K = 6$ and $a = 4$ then the open loop characteristic equation is $s^4 + 5s^3 + 5s^2 + 8s + 4 = 0$ and using the Routh-Hurwitz array (see reference 1 Appendix B) gives

Row label			
s^4	1	5	4
s^3	5	8	
s^2	17/5	4	
s	36/17		
s^0	4	.	.

There are no sign changes in the first computed column so the system is stable.

b) Consider now the case when K is unknown and $a = 4$ then the array becomes

Row label			
s^4	1	5	K
s^3	5	$4+K$	
s^2	$(21-K)/5$	K	
s	$(K^2+8K-84)/(K-21)$		
s^0	K	.	.

and it can be seen that the penultimate term in the first computed column is negative for $K > 6$. Checking the roots in Matlab for $K = 6$ gives

```
>> roots([1 5 5 10 6])
```

```
ans =
```

```
-4.3028
```

```
-0.0000 + 1.4142i
```

```
-0.0000 - 1.4142i
```

```
-0.6972
```

showing that the two complex roots have zero real part.

$G(s)$ has one zero at -1 , and four poles at 0 , $-0.5 \pm 0.866j$ and -4 . Thus root loci start from the four poles, will exist on the negative real axis between 0 and -1 and between -4 and $-\infty$ and the loci starting from the complex poles will pass into the rhs of the plane for $K = 6$, tending to asymptotes at $\pm 60^\circ$, which intersect on the negative real axis at $-4/3$. The Matlab plot is shown in Figure 5.1 and this allows the location of the closed loop poles to be found for different values of K .

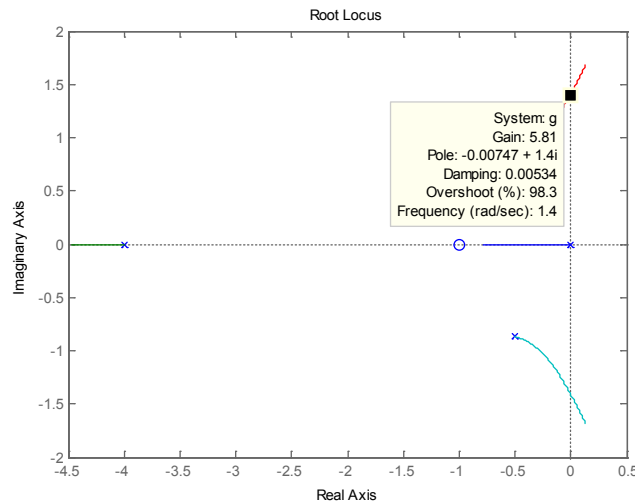

Figure 5.1 Root locus plot for gains from 0 to 10 for example 5.1.



Technical training on *WHAT* you need, *WHEN* you need it

At IDC Technologies we can tailor our technical and engineering training workshops to suit your needs. We have extensive experience in training technical and engineering staff and have trained people in organisations such as General Motors, Shell, Siemens, BHP and Honeywell to name a few.

Our onsite training is cost effective, convenient and completely customisable to the technical and engineering areas you want covered. Our workshops are all comprehensive hands-on learning experiences with ample time given to practical sessions and demonstrations. We communicate well to ensure that workshop content and timing match the knowledge, skills, and abilities of the participants.

We run onsite training all year round and hold the workshops on your premises or a venue of your choice for your convenience.

For a no obligation proposal, contact us today at training@idc-online.com or visit our website for more information: www.idc-online.com/onsite/

Phone: **+61 8 9321 1702**
Email: **training@idc-online.com**
Website: **www.idc-online.com**

**OIL & GAS
ENGINEERING**

ELECTRONICS

**AUTOMATION &
PROCESS CONTROL**

**MECHANICAL
ENGINEERING**

**INDUSTRIAL
DATA COMMS**

**ELECTRICAL
POWER**



Figure 5.2 shows Mikhailov plots for the polynomial with three different gains K , from which it can again be seen that system is stable for $K = 4$, neutrally stable for $K = 6$, and unstable for $K = 8$. For $K = 4$ although the system is stable the pole locations are -4.21 , -0.608 and $-0.091 \pm 1.25j$, so the complex pair are quite near to the imaginary axis.

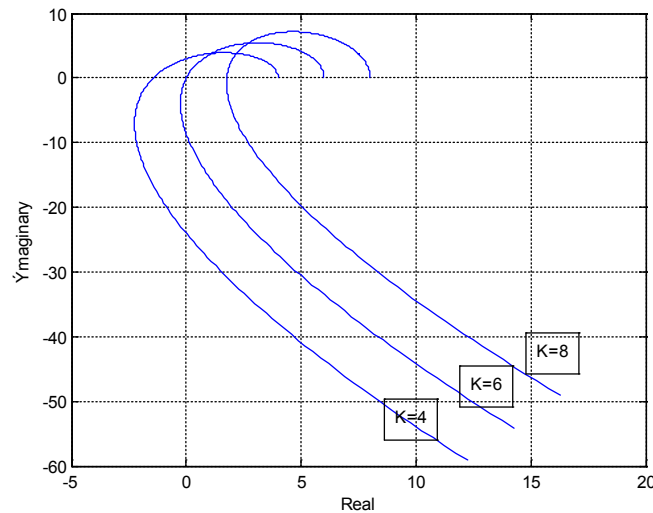

Figure 5.2 Mikhailov plots for Example 5.1 with three different gains K .

The routine used for the Mikhailov plot, as one is not given in Matlab, was:-

```
function mikplot(w,p)

for i=1:length(w);
    num=p;
    den=[1];
    [rea(i),ima(i)]=nyquist(num,den,w(i));
end
plot(rea,ima)
xlabel('Real')
ylabel('Ymaginary')
grid
```

where the inputs required are the (angular) frequency string in w and the polynomial coefficients in p . Since the magnitude on the plot increases rapidly with frequency after crossing the final axis the last frequency value in w has to be selected with care to get a good plot.

c) Consider now the case of a variable and $K = 4$. The characteristic equation is now

$s^4 + (1+a)s^3 + (1+a)s^2 + (4+a)s + 4 = 0$ and the Hurwitz-Routh array is

Row label			
s^4	1	$1+a$	4
s^3	$1+a$	$4+a$	
s^2	$(a^2+a-3)/(1+a)$	4	
s	$(a^3+a^2-7a-16)/(a^2+a-3)$		
s^0	4	.	.

The s^2 term is positive for $a > 1.30$ and the s term is positive for $a > 1.30$ and $a > 3.04$, therefore the system is stable for $a > 3.04$. It can be seen from this array involving a and the previous one involving K that the arrays can involve quite cumbersome algebra for large order polynomials with an unknown parameter.

To plot a root locus to show how the roots vary, the above equation can be divided by the terms not

involving a to give $1 + \frac{a(s^3 + s^2 + s)}{s^4 + s^3 + s^2 + 4s + 4} = 0$ and the root locus is plotted for an open loop transfer

function of $G(s) = \frac{a(s^3 + s^2 + s)}{s^4 + s^3 + s^2 + 4s + 4}$ where a replaces K as the parameter on the locus. The transfer

function is typically unlike a usual open loop transfer function and the numerator and denominator

have to be factored to get the poles and zeros. From Matlab the zeros are at $0, -0.5 \pm 0.866j$ and the poles

at $0.67 \pm 1.46j, -1.17 \pm 0.42j$. The root locus is shown in Figure 5.3 for $a = 1$.

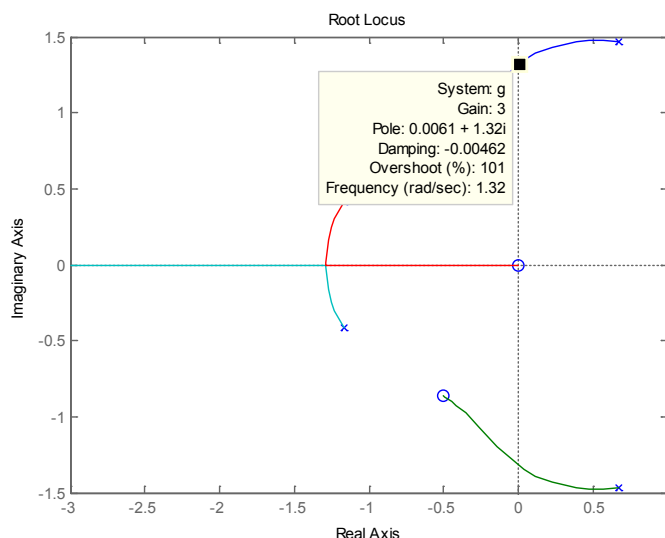

Figure 5.3 Root locus for the variable parameter a

Example 5.2

Consider now the frequency response properties of the same open loop transfer function as Example 5.1 with $a = 4$ and $K = 1$. The Nyquist diagram is shown in Figure 5.4.

I joined MITAS because
I wanted **real responsibility**

The Graduate Programme
for Engineers and Geoscientists
www.discovermitas.com

Real work
International opportunities
Three work placements

Month 16
I was a construction
supervisor in
the North Sea
advising and
helping foremen
solve problems



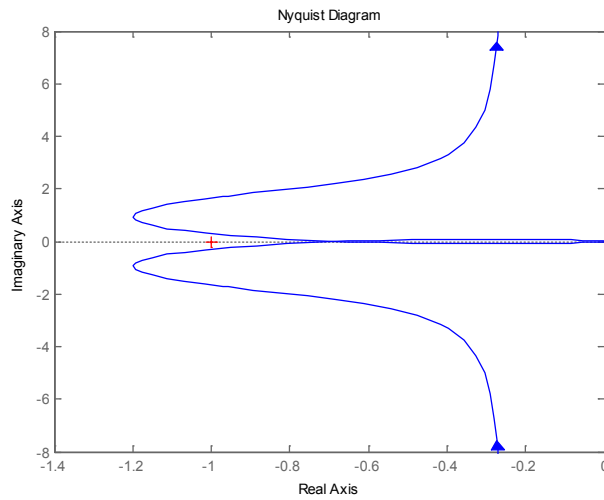

Figure 5.4 Nyquist diagram for transfer function

To find the gain margin and phase margin for this transfer function one can obviously use the cursor on the Nyquist plot, although to get any reasonable accuracy one would obviously have to do a replot of Figure 5.4 over a more suitable frequency range. However if the Matlab command 'margin(G)' is used then the Bode diagrams for the transfer function G are drawn as shown in Figure 5.5. The gain and phase margins are indicated on the figure with interpolation of the frequency vector points used in the plot employed to give their values quite accurately above the plot. For this case the gain margin is 3.52dB and the phase margin 14.4° , both of which are low. This is expected from the pole locations given in the previous example. Provided the feedback transfer function $H = 1$, which will be assumed, any peak in the closed loop frequency response can be found by placing M circles on the Nyquist plot, which can be done in Matlab by right clicking on the plot with the mouse and selecting 'grid' from the menu obtained. The result is shown in Figure 5.6 where a frequency vector has been selected with $a=-0.3$ and $b=2$ in the 'logspace' command.

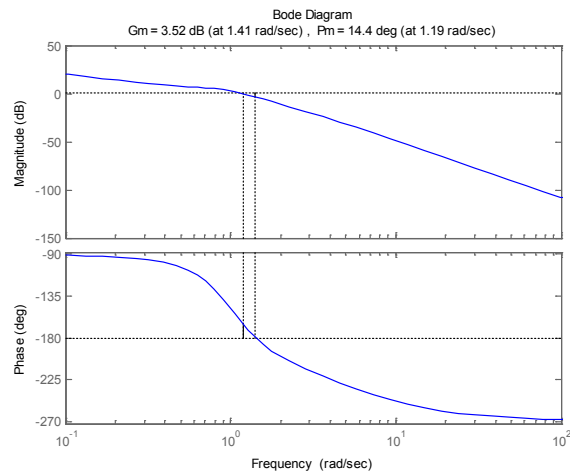

Figure 5.5 Bode diagram showing gain and phase margins.

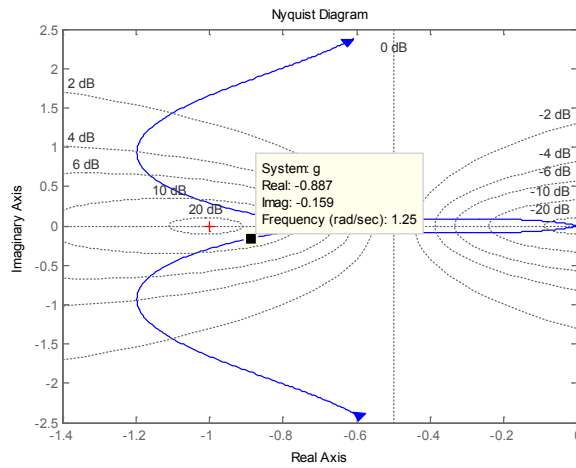

Figure 5.6 M circles on the Nyquist plot for Example 5.2.

From Figure 5.6 it can be seen that a peak in the closed loop frequency response of around 15dB at a frequency of 1.25 can be expected, which is confirmed in Figure 5.7.

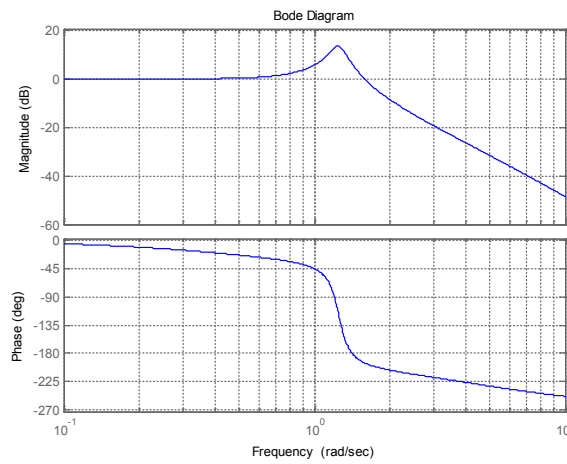

Figure 5.7 Closed loop frequency response plot for Example 5.3.

Example 5.3.

Consider again the transfer of Example 4.6, namely $G(s) = \frac{1 + sT_1}{s(1 + sT_2)(1 + sT_3)}$, with the parameter values $T_2 = 1$ and $T_3 = 2$. It is required to investigate the values of additional loop gain K for the choice of $T_1 = 3$ which will result in a closed loop frequency response with no resonant peak.

The image is a promotional banner for Oticon. It features a collage of four smaller images: a person working at a computer, a man holding a document, and two women in business attire talking. A large blue wave graphic flows across the bottom of the collage. In the bottom left corner, the text 'www.job.oticon.dk' is displayed. In the bottom right corner, the Oticon logo is shown with the tagline 'PEOPLE FIRST'.

www.job.oticon.dk

oticon
PEOPLE FIRST



It can be seen from Figure 5.6 that to satisfy this condition the frequency response of the forward loop transfer function $G(s)$ must not have a negative real part greater than 0.5, as the M circle for 0dB is a straight line parallel to the imaginary axis and passing through -0.5. From example 4.6,

$\text{Re } G(j\omega) = \frac{-\omega^2 T_1 T_2 T_3 + (T_1 - T_2 - T_3)}{(1 + \omega^2 T_2^2)(1 + \omega^2 T_3^2)}$, which with the parameter values $T_2 = 1$ and $T_3 = 2$ substituted gives $\text{Re } G(j\omega) = \frac{-2\omega^2 T_1 + (T_1 - 3)}{(1 + \omega^2)(1 + 4\omega^2)}$. Replacing ω^2 by u , differentiating the expression with respect to

u and equating to zero gives $(1 + u)(1 + 4u) * 2T_1 + (T_1 - 3 - 2uT_1)(5 + 8u) = 0$, which on solving the quadratic for u gives $u = \frac{-(12 - 4T_1) + (58T_1^2 - 132T_1 + 18)^{1/2}}{8T}$. For the particular choice of $T_1 = 3$ this

gives the nice solution of $u = 0.5$ and the corresponding maximum negative value of $\text{Re } G(j\omega)$ as 0.667.

Thus for this choice of T_1 the maximum value of the gain K for no peak in the closed loop frequency response is 0.75. The frequency response of $0.75G(j\omega)$ is shown in Figure 5.8 on a Nyquist plot with M circles, and the Bode diagram for the closed loop frequency response with $H = 1$ in Figure 5.9.

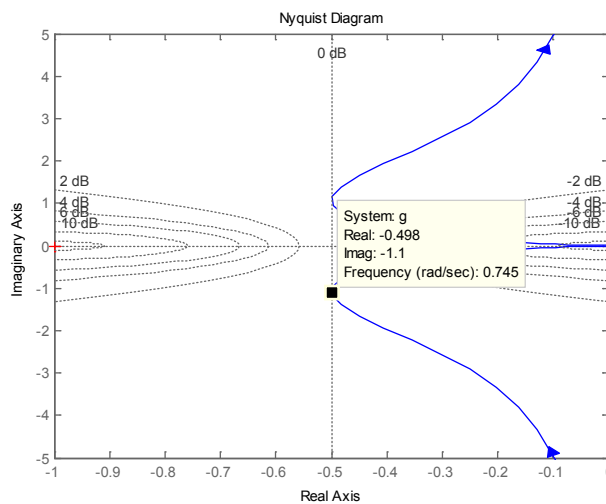

Figure 5.8 Nyquist plot of $KG(j\omega)$ for example 5.3.

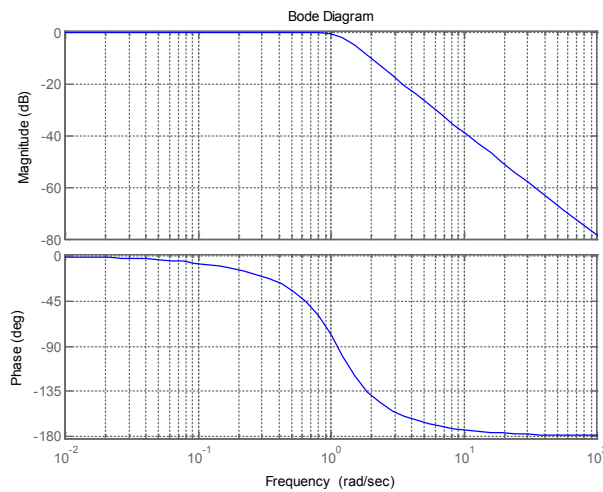

Figure 5.9 Closed loop frequency response for example 5.3.

Example 5.4.

Determine the range of K for stability from the Nyquist plots of closed loop systems with the following open loop transfer functions.

$$\text{a) } G(s) = \frac{K(s+1)}{(s^2+1)(s+2)}.$$

$$\text{b) } G(s) = \frac{K(s+1)}{(s^2-0.2s+1)}.$$

$$\text{c) } G(s) = \frac{K(s+1)^2}{s(s-2)(s-1)}.$$

$$\text{d) } G(s) = \frac{10K(s+1)^2}{s^3(s^2+1.2s+16)}.$$

The solutions to these types of questions are often most easily done using the Routh-Hurwitz criterion or the root locus but they are done here to show applications of the Nyquist Criterion.

a) The first example contains a lead term, a lag term and a second order lag with no damping. For $K = 1$ it starts on the real axis at 0.5 and finishes at the origin with a phase of 180°. Because there is no damping in the second order lag the Nyquist plot goes to infinity for $\omega = 1$, so that use of the Matlab command 'nyquist' gives the very uninformative plot shown in Figure 5.10.

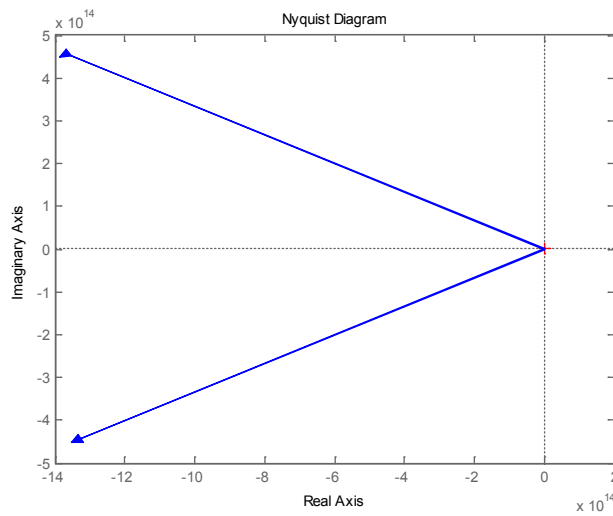

Figure 5.10 Nyquist plot for $G(s)$ of example 5.4(a).

One can generate a frequency vector by taking a set of points from near zero to just less than $\omega = 1$ and another set from just above $\omega = 1$ to a relatively large value and then plot the Nyquist as shown below to obtain the plot in Figure 5.11

Schlumberger

WHY WAIT FOR PROGRESS?

DARE TO DISCOVER

Discovery means many different things at Schlumberger. But it's the spirit that unites every single one of us. It doesn't matter whether they join our business, engineering or technology teams, our trainees push boundaries, break new ground and deliver the exceptional. If that excites you, then we want to hear from you.

careers.slb.com/recentgraduates



```

>> w1=logspace(-2,-0.05,500);
>> w2=logspace(0.05,2,500);
>> w=[w1 w2];
>> nyquist(g,w)

```

The problem with this plot is that the plot routine joins together the points obtained after the low frequency plot is obtained from A (textbox added) to B, the last point at B is joined to C the start of the high frequency plot. This means the infinite semicircle is replaced by the straight line from B to C.

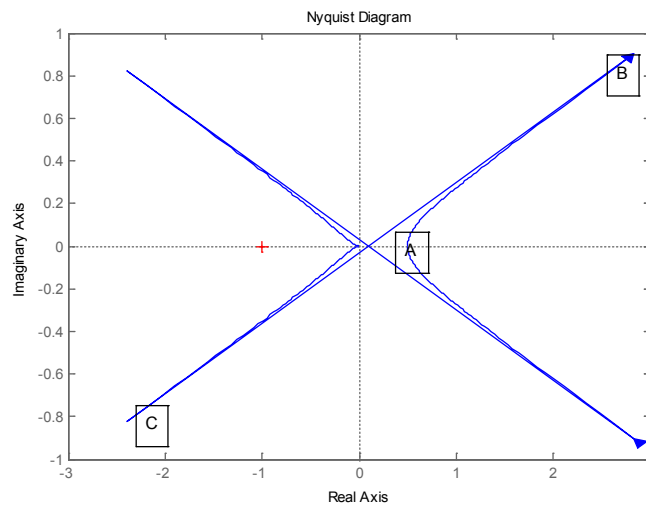

Figure 5.11 Nyquist plot for defined frequency vector for example 5.4(a).

Alternatively, two separate plots can be done one for the frequencies below $\omega = 1$ and the other for the frequencies above to obtain Figure 5.12 by using the Matlab statements:-

```

>> nyquist(g,w1)
>> hold
Current plot held
>> nyquist(g,w2)

```

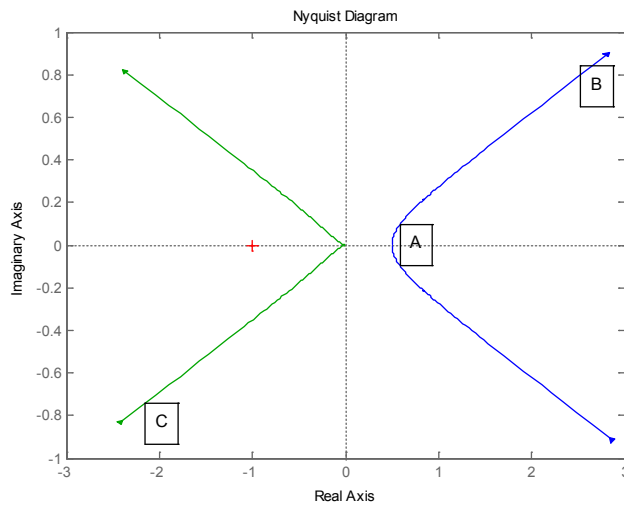

Figure 5.12 Nyquist plot for two frequency vectors for example 5.4(a).

The true plot has an infinite semicircle from beyond B to before C so there is no encirclement of the (-1, 0) point. i.e. $N=0$. Also since the transfer function has no rhs s-plane poles, $P=0$, and the loop is stable for $K > 1$.

b) The Nyquist plot of $G(s) = \frac{K(s+1)}{(s^2 - 0.2s + 1)}$ for $K = 1$ starts at 1 on the real axis and finishes at the origin with a phase of -90° . It is easy to show that it crosses the real axis at -5. Since there are two complex rhs s-plane poles $P = 2$. The plot is shown in Figure 5.13 and it has two counter clockwise encirclements of the (-1, 0) point so $N = -2$. Thus Z the number of rhs s-plane closed loop poles is $2 - 2 = 0$ and the closed loop system is stable.

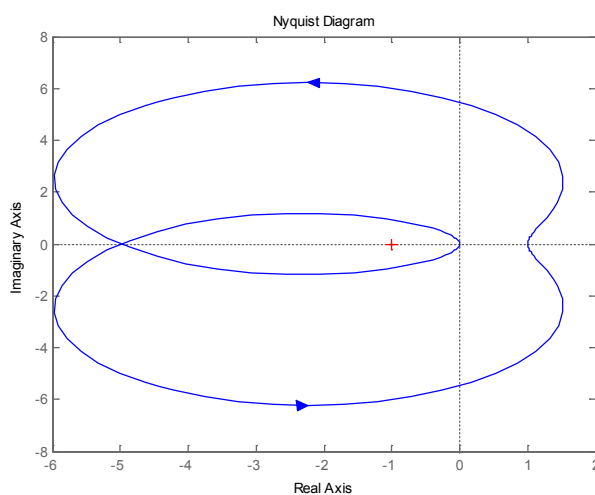

Figure 5.13 Nyquist plot for example 5.4(b)

If the gain K is reduced to less than 0.2, however, there will be no encirclements of the $(-1, 0)$ point, so that $N = 0$ and $Z = 2$. Thus the system is unstable for $K > 0.2$.

c) For this case $G(s) = \frac{K(s+1)^2}{s(s-2)(s-1)}$ and the Nyquist locus is seen to start at infinity with a phase of -90° and finish at the origin with a phase of -90° . There are two real rhs s -plane poles so $P = 2$. The Nyquist plot is shown in Figure 5.14 for $K = 1$ using a defined frequency vector to obtain a better plot near the origin. Before the closed loop stability can be assessed the infinite semicircle closure needs to be found. Theoretically this is done by taking a small semicircle in the rhs s -plane mapping around the pole at the origin. If this is done as frequency increases along the imaginary axis from a negative to a positive value (the argument goes from -90° through 0° to $+90^\circ$) then the argument in $G(s)$ changes from $+90^\circ$ through 0° to -90° so the infinite semicircle on $G(j\omega)$ is in the rhs s -plane. This is confirmed in Figure 5.15 where a 'leaky integrator' with $\varepsilon = 0.05$ has been used.

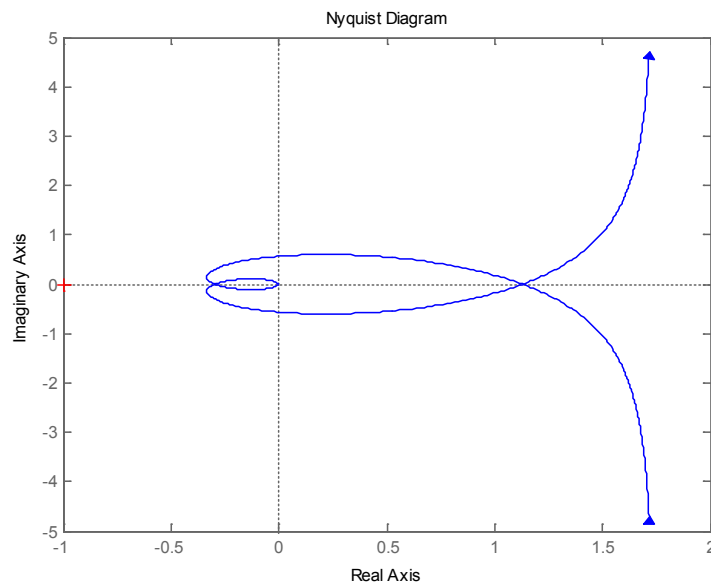

Figure 5.14 Nyquist plot for Example 5.4(c)

Thus for $K = 1$, $N = 0$ and the closed loop system is unstable. As the gain is increased the Nyquist point $(-1, 0)$ will eventually lie inside the double loop at the lhs of the plot. The point where the Nyquist crosses the negative real axis can be found using the 'margin' command, which gives a gain margin of 10.6dB, or by obtaining a more accurate graph near to the crossover frequency. Note the margin command gives a gain where the phase is -180° , it does not indicate stability. The corresponding gain is $10^{dB/20} = 10^{10.6/20} = 3.39$. Thus for gains greater than this value there will be two counter clockwise encirclements of the $(-1, 0)$ point, giving $N = -2$, so that $Z = 0$ and the closed loop system will be stable. Thus the closed loop system is stable for gains greater than 3.39 which is confirmed by the Hurwitz-Routh criterion.

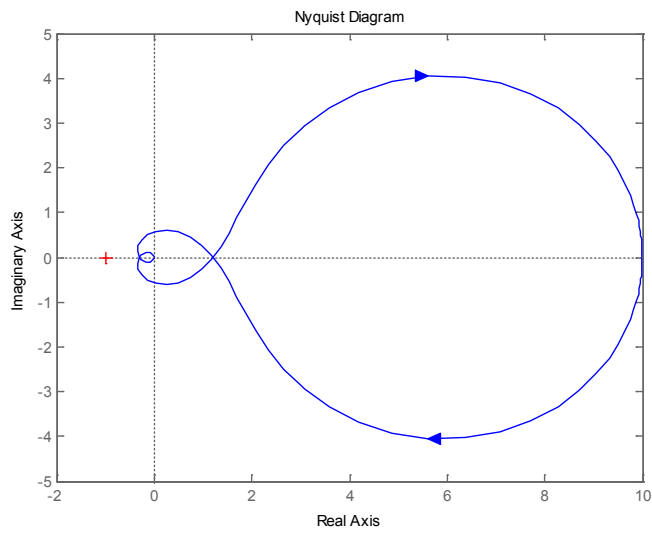

Figure 5.15 Nyquist plot for Example 5.4(c) with a 'leaky integrator'.

PREPARE FOR A LEADING ROLE.

English-taught MSc programmes in engineering: Aeronautical, Biomedical, Electronics, Mechanical, Communication systems and Transport systems. No tuition fees.

→ liu.se/master

li.u LINKÖPING UNIVERSITY



d) In this case $G(s) = \frac{10K(s+1)^2}{s^3(s^2+1.2s+16)}$ and since the transfer function contains a triple integration it starts at low frequencies at infinity with a phase of -270° and finishes at the origin with the same phase of -270° . The numerator lead time constants are both at unity and the lag term is second order with a frequency of 4 rad/s. and a light damping ratio of 0.15. There is thus a possibility it may cross the negative real axis. The default Nyquist plot with $K = 1$ is shown in Figure 5.16. This is of no good for assessing stability because the detail for frequencies near the origin is missing and the closures at infinity are not of course given. For the latter it can be shown theoretical that as the frequency increases around the small semicircle to the right of the three poles at the origin the phase of the transfer function due to the three poles changes from 270° (-90°) through 180° , 90° and 0° and continues to -270° ($+90^\circ$), that is a total phase change on the Nyquist plot of 540° in a clockwise direction with increasing frequency.

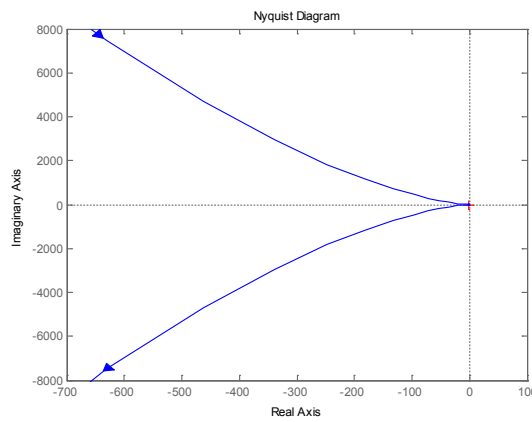

Figure 5.16 Nyquist plot for example 5.4(d).

To examine the plot near the origin a frequency vector from $10^{-0.3}$ to 10^2 was used and the plot is shown in Figure 5.17.

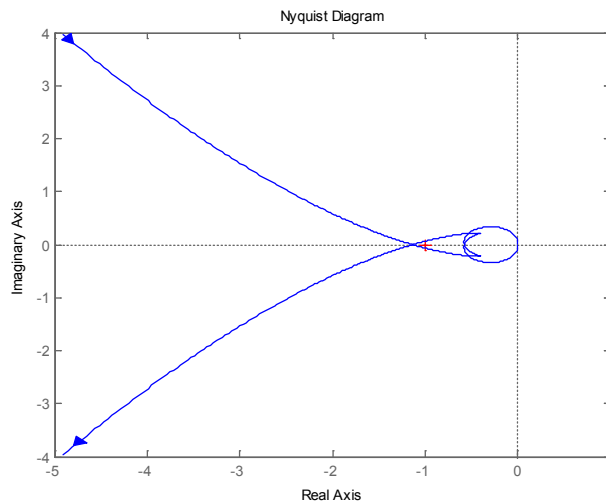

Figure 5.17 Nyquist plot for higher frequencies for example 5.4(d)

The negative real axis is cut at approximately -1.14 and -0.574. For $K = 1$ the encirclements $N = 0$ as the small one near the origin is in the counterclockwise direction and the one at infinity is in a clockwise direction. For gains less than $1/1.14 = 0.877$ or greater than $1/0.574 = 1.74$ the Nyquist point will be encircled twice in the clockwise direction, giving $N = 2$. The system is therefore stable for $0.88 < K < 1.74$.

Example 5.5

Obtain the root locus for the transfer function given in Example 5.4(d).

The transfer function has a gain of 10, two zeros at -1 and five poles three at the origin and the other two at $-0.6 \pm 3.95j$. The relative degree is 3 so that three loci tend to infinity along asymptotes at $\pm 60^\circ$ and 180° , which intersect at 0.8 on the real axis. There is a locus on the negative real axis from the origin (i.e. to the left of an odd number of singularities) to infinity, and since the system is unstable for small gains the other two branches from the origin must initial go into the rhs s-plane. Since the system becomes stable for a small gain range it is likely that the roots starting at the two complex poles move into the rhs s-plane for a gain slightly higher than that obtaining when the complex root paths from the origin move into the lhs s-plane. The plot obtained from Matlab is shown in Figure 5.18 from which it will be seen that the gain range for stability agrees with that from the Nyquist criterion.

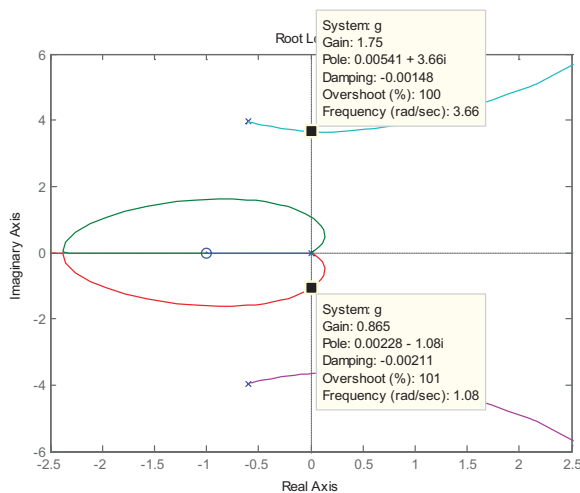

Figure 5.18 Root locus plot for Example 5.4(d)

Example 5.6

Find the value of α and the corresponding value of K on the root locus for all three roots on the locus to be real and equal for the transfer function $G(s) = \frac{K(1 + sT)}{s^2(1 + \alpha sT)}$. Show further that as α goes through this value the shape of the root locus changes and also that for this choice of α the required value of K to provide a maximum phase margin for the closed loop system will be the same as found previously.

It is convenient to do a time scale on the transfer function and replace sT by p so that the transfer function becomes $G(p) = \frac{k(1+p)}{p^2(1+\alpha p)}$ where $k = KT^2$. The closed loop characteristic equation is $p^3 + \lambda p^2 + k\lambda p + k\lambda = 0$ where $\lambda = 1/\alpha$. Assuming the three equal roots are β then equating the coefficients of the characteristic equation with the expansion of $(p + \beta)^3$ gives $\lambda = 3\beta$, $k\lambda = 3\beta^2$ and $k\lambda = \beta^3$ from which $\beta = 3$, $\lambda = 9$ and $k = 3$. Thus the root locus for $G(s)$ has three equal poles when $\alpha = 1/9$ and $K = 3/T^2$. The transfer function has three poles, two at the origin and one at $-\lambda$, and a zero at -1 . From the root locus rules one can conclude that (i) there is a locus on the negative real axis between the pole and zero and (ii) two roots go to infinity approaching asymptotes at $\pm 90^\circ$, which intersect on the real axis at the point $(\lambda - 1)/2$. Since the system is stable for all gains the two root locus branches starting from the origin must move into the left half plane but what is not known without further investigation is whether these branches go to infinity along the asymptotes or return first to the negative real axis which according to the previous calculation must be the case when $\lambda = 9$, that is $\alpha = 1/9$. The root loci are shown in Figure 5.19 for the three values of $\alpha = 1/8$, $\alpha = 1/9$ and $\alpha = 1/10$, respectively.

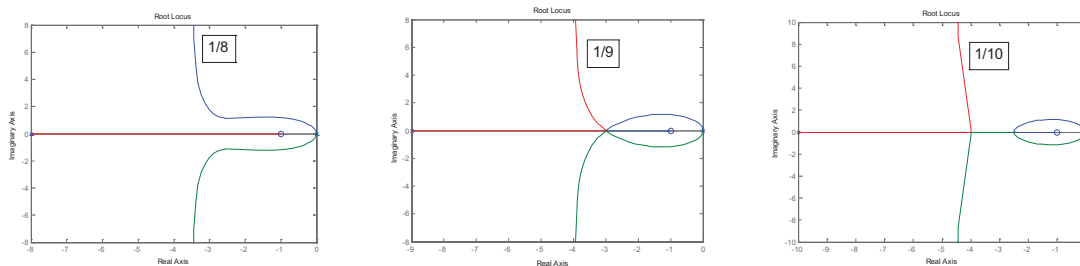

Figure 5.19 Root loci for three values of α for example 5.6.

The maximum phase lead provided by $\frac{1+sT}{1+\alpha sT}$ is $\sin^{-1} \frac{1-\alpha}{1+\alpha}$ at a frequency of $\omega = 1/T\sqrt{\alpha}$ where the gain is $\sqrt{\alpha}$. Thus for $\alpha = 1/9$ the maximum phase lead is $\sin^{-1}(0.8) = 53.1^\circ$ at a frequency of $\omega = 3/T$ where the gain is 3. Therefore if $\omega = 3/T$ is taken as the phase margin frequency, then the phase margin will be a maximum if $|G(j\omega)|$ has unit gain at this frequency. This means $\frac{K}{(9/T^2)} * 3 = 1$, giving $K = 3/T^2$, as before.

Example 5.7

A feedback system has an open loop transfer function of $G(s) = \frac{Ke^{-0.5s}}{s(s+1)}$. Calculate its gain and phase margins for $K = 1$ and determine the maximum value of K for stability. Obtain the approximate value of K for stability using the Routh-Hurwitz criterion and the standard expansion for the exponential up to order 2, and from the Pade approximation of order 3 to 1.

The effects of time delay in a feedback loop are often most easily studied using Nyquist plots as a time delay has unit gain at all frequencies and a phase shift which increases linearly with increase in frequency. Thus the given $G(s)$ will have a phase shift of 180° when $\tan^{-1} \omega + 0.5\omega = 90^\circ$ which has a solution of $\omega = 1.307$. The gain at this frequency is $K |G(j\omega)| = \frac{1}{1.307(1+1.307^2)^{1/2}} = 0.465$. Thus the gain margin in dB for $K = 1$ is $20 \log_{10}(1/0.465) = 6.65$ and the value of gain for which the closed system goes unstable is 6.65dB or 2.15. The gain is $\frac{1}{\omega(1+\omega^2)^{1/2}}$ and this is equal to unity when $\omega^4 + \omega^2 = 1$, which has the solution $\omega = 0.786$. The phase shift at this frequency is $-90^\circ - \tan^{-1}(0.786) - (0.393 * 180 / \pi)^\circ = -150.69^\circ$, giving a phase margin of 29.31° . To check in Matlab the transfer function without the delay, say g, is entered and then the statement

```
>> g.inputd=0.5;
```

**TAKE THE
RIGHT TRACK**

**Give your career a head start
by studying with us. Experience the advantages
of our collaboration with major companies like
ABB, Volvo and Ericsson!**

Apply by
15 January

World class
research

www.mdh.se

MÄLARDALEN UNIVERSITY
SWEDEN

Click here
to learn more



Click on the ad to read more

produces a new transfer function g with the delay. The Nyquist plot for $K = 1$ for the transfer function is shown in Figure 5.20 using a defined frequency vector. If the comment 'margin(g)' is used then a Bode plot with the gain and phase margin values is given which confirms the above calculations

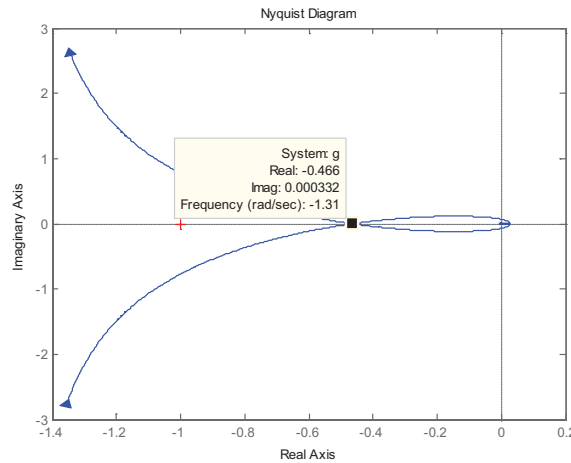

Figure 5.20 Nyquist plot for $G(s)$ of Example 5.7 with $K = 1$.

The characteristic equation is $s^2 + s + Ke^{-0.5s} = 0$, which on substituting the first three terms of the expansion for the exponential gives $s^2 + s + K(1 - 0.5s + 0.125s^2) = 0$. This will give a stable system if all the coefficients are positive, which is true for $K < 2$. Using the 3/1 Pade expansion in the characteristic equation gives $(s^2 + s)(1 + 0.125s) + K(1 - (3/8)s + (1/16)s^2 - (1/8 * 24)s^3) = 0$ which gives $s^3[1 - (K/24)] + s^2[9 + (K/2)] + s[8 - 3K] + 8K = 0$.

One of the coefficients becomes negative for $K > 8/3$ but it is also required for stability that $8K[1 - (K/24)] < [9 + (K/2)][8 - 3K]$ which gives $(7/6)K^2 + 31K - 72 < 0$, which is true for $K < 2.149$, showing very good agreement with the exact result.

Example 5.8

The frequency normalised open loop transfer function $G(s)$ corresponding to the standard underdamped second order closed loop transfer function $1/(s^2 + 2\zeta s + 1)$ is $G(s) = 1/s(s + 2\zeta)$. Determine the phase margin for $G(s)$ in a unit negative feedback system. Plot this phase margin and the percentage overshoot for the step response of the closed loop system against the damping ratio ζ . {Note the correlation of these two relationships is often used in open loop frequency response design to estimate the overshoot in the closed loop step response of the system – see problem 5.8 and chapter 7}.

The transfer function $G(s)$ has unit gain when $|1/\omega(j\omega + 2\zeta)| = 1$, that is $1/[\omega(\omega^2 + 4\zeta^2)^{1/2}] = 1$. This gives $\omega^4 + 4\zeta^2\omega^2 + 1 = 0$ which has the positive solution $\omega^2 = \sqrt{4\zeta^2 + 1} - 2\zeta^2$. The phase of $G(j\omega)$ is $-(\pi/2) - \tan^{-1}(\omega/2\zeta)$ rads, so that the phase margin is $\tan^{-1}(2\zeta/\omega) = \tan^{-1}(2\zeta/[\sqrt{(4\zeta^2 + 1)} - 2\zeta^2]^{1/2})$.

The percentage overshoot for the closed loop step response is $100 \exp(-\zeta\pi / \sqrt{1-\zeta^2})$. The results are shown plotted against ζ in Figure 5.21.

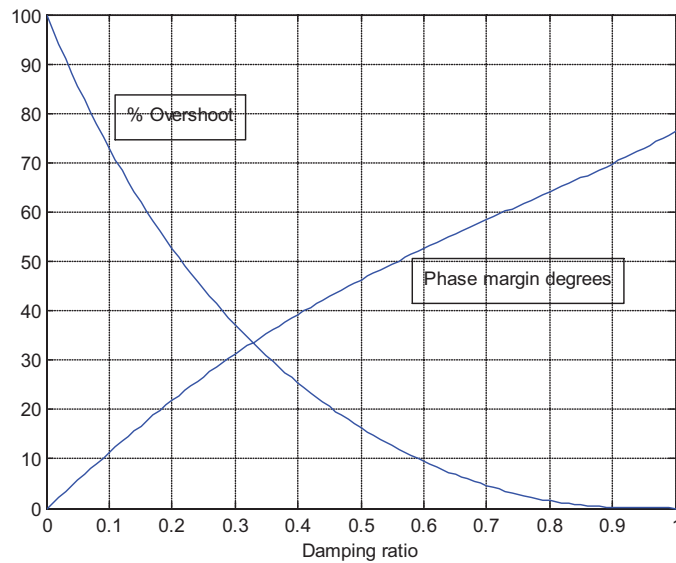

Figure 5.21 Percentage overshoot and phase margin for second order system

5.3 Problems

Problem 5.1

Check the results obtained in Example 5.4 using the Routh-Hurwitz criterion.

Problem 5.2

Check the results obtained in Example 5.4 from root locus plots.

Problem 5.3

Obtain the solution for the gain K of Example 5.3 if the time constants have the values $T_1 = 6$, $T_2 = 1$, and $T_3 = 2$.

[0.555]

Problem 5.4

The transfer function of problem 4.8 $G(s) = \frac{s^2 + s + 4}{s(s-1)(s+1)}$ is in a closed loop unit negative feedback system with a compensator of gain K . Use the Nyquist criterion to find the values of K for which the system will be stable and check your result using the Routh-Hurwitz criterion and a root locus plot. Obtain the Mikhailov plot for the critical value of K .

$[K > 5]$

Problem 5.5

For the following transfer functions obtain the range of positive values of K for which the system will be stable by the Routh-Hurwitz criterion and use of the Nyquist diagram drawn for $K = 1$

a) $G(s) = \frac{K(s+1)^2}{s(s^2-4)}$

b) $G(s) = \frac{K(s+1)}{s-0.1s+1}$

c) $G(s) = \frac{K(s+1)^2}{(s+3)(s+2)(s-1)}$

d) $G(s) = \frac{K(s+8)}{(s+2)(s^2+0.35)}$

e) $G(s) = \frac{K(1-s)}{s(1+s)^2}$

f) $G(s) = \frac{K(s+1)^2}{s(s^2-4)(0.1s+1)}$



**WE ARE SHAPING
MOBILITY FOR
TOMORROW**

How will people travel in the future, and how will goods be transported? What resources will we use, and how many will we need? The passenger and freight traffic sector is developing rapidly, and we provide the impetus for innovation and movement. We develop components and systems for internal combustion engines that operate more cleanly and more efficiently than ever before. We are also pushing forward technologies that are bringing hybrid vehicles and alternative drives into a new dimension – for private, corporate, and public use. The challenges are great. We deliver the solutions and offer challenging jobs.

www.schaeffler.com/careers

SCHAEFFLER



[stable $K > 2.5$, stable $K > 0.1$, stable $N = 0$, unstable all positive K , stable $K < 2/3$, stable $K > 2.5$]

Problem 5.6

Calculate the maximum value of K for stability of the transfer function $G(s) = \frac{Ke^{-s}}{s(s+2)^2}$ in a unit negative feedback system. Obtain the exact value from a Nyquist plot and approximate values from the Routh-Hurwitz criterion using Pade expansions for e^{-s} of order 3/0, 1/1.

[3.743 (11.46dB); 3.76; 3.88]

Problem 5.7

A system with unit negative feedback has an open loop transfer function $G(s) = K/s(s+3)^2$. Sketch its Nyquist diagram for $K = 10$ and find its magnitude and frequency when the phase is -180° . Calculate also the asymptote to which it tends at zero frequency and the critical gain of K , K_c , for which it is just stable. If K is chosen equal to $K_c/2$ show that it will have a gain of unity at the frequency $\omega = 2.047$ rads/s and calculate the phase margin of the system. If $K = K_c/2$ and the feedback transfer function $H(s) = e^{-sT}$, find the maximum value of T for which the system will be stable. Check your results with Matlab.

[10/54, 3 rads/s.; 20/27, 54; 21.4°; 0.183s.]

Problem 5.8

A system with unit negative feedback has an open loop transfer function $G(s) = 100K/s(s+10)^2$. Calculate the maximum value of K for which the system is stable. Sketch the root locus, determine any breakaway points and the value of K for which they occur and the frequency at which the imaginary axis is crossed. Show that if $K = 3$ the closed loop poles are at -14.54 and $-2.73 \pm 3.63j$. Calculate the phase margin for the closed loop system for this value of K and obtain the percentage overshoot from the Matlab closed loop step response.

Assuming the system is approximated by a second order one with the above complex poles, what will be the damping ratio, percentage overshoot for the closed loop step response and the phase margin (see the graphs in example 5.8). What can you conclude from these results about using phase margin criteria for designing third or possibly higher order systems where the desired performance is a limit on the closed loop step response overshoot.

[20; +5, 40/27, 10rads/s; 58.9°, 8.87%; 0.60, 9.48%, 52.6°, you will normally have to use a higher phase margin to achieve a given overshoot than indicated by Figure 5.21.]

Problem 5.9

Determine from the Nyquist plot and the use of 'M circles' the maximum allowable value of K for the system of Problem 5.8 to have a closed loop frequency response with a maximum magnitude of 4dB. Check the result by using Matlab to plot the closed loop frequency response.

[≈6]

Problem 5.10

Using the standard notation a feedback control system has $G(s) = 1/s(s+2)^2$, $G_c(s) = K$ and $H(s) = 1$.

- Find the value of K which just causes the system to go unstable.
- Find the value of K if the closed loop frequency response must not exceed 0dB.
- If a time delay exists in the feedback path so that $H(s) = e^{-0.5s}$, find the new value of K which just causes the system to go unstable.
- Check the last result by finding the solution from the Routh criterion using the approximation $e^{-x} = 1 - x + (x^2/2!) - (x^3/3!)$

[(a) 16, (b) 2, (c) 5.81, (d) 5.83]

Problem 5.11

A system has an open loop transfer function $G(s)$ and unit negative feedback. Make use of M circles to find the maximum value of gain K for the closed loop frequency response never to exceed unit gain if-

- $G(s) = K/s(s+a)$
- $G(s) = K/s(s+1)^2$
- $G(s) = K/(s+1)^3$

[(a) $K < a^2$ (b) $K < 0.25$ (c) $K < 2$]

6 State Space Models and Transformations

6.1 Introduction

The purpose of the examples in this chapter is to cover basic aspects of state space modelling, transfer functions of state space models, transformations between state space representations, controllability and observability and the response of state space models with external inputs and initial conditions. These topics are covered in chapter 10 of reference 1. The first example deals with the physical modelling of a permanent magnet dc motor driving a load through gearing. The following 7 examples use a limited number of state space models, which allows the relationships between the various methods of determining their state space properties and transfer functions to be compared. Finally an example is given on pole placement using state variable feedback to show the value of doing this by first transforming the system to the controllable canonical form.

6.2 Examples

Example 6.1

A permanent magnet dc motor drives a load through a speed reducing gear box of ratio, n . The motor is supplied from a voltage, v , has an armature resistance, R , and inductance L , and the inertias and viscous friction coefficients of the motor and load shafts are J_m, F_m and J_L, F_L , respectively. Find the transfer function for the motor from input voltage to output shaft position and state space models for the motor using (i) the output position and its derivatives as state variables and (ii) the output position, velocity and motor current as state variables. What do these state space models become if the motor inductance can be neglected?

The equations of motion for the motor and load shafts are

$$T_m - Fr_m = J_m \ddot{\theta}_m + F_m \dot{\theta}_m$$

and

$$Fr_L = J_L \ddot{\theta}_L + F_L \dot{\theta}_L$$

where θ_m and θ_L are the motor and load shaft positions, F is the force between the gear teeth and the r 's the radii of the motor and load shaft gears.

Using the facts that $\theta_m = n\theta_L$ and $r_L = nr_m$ the single equation of motion referred to either the motor or load shafts becomes

$$T_m = (J_m + J_L / n^2) \ddot{\theta}_m + (F_m + F_L / n^2) \dot{\theta}_m$$

or

$$nT_m = (J_L + n^2 J_m)\ddot{\theta}_L + (F_L + n^2 F_m)\dot{\theta}_L$$

Taking the first equation and denoting the total inertia and friction referred to the motor shaft by J and F , that is $J = J_m + J_L / n^2$ and $F = F_m + F_L / n^2$ and dropping the subscripts m gives

$$T = J\ddot{\theta} + F\dot{\theta}$$

Since the motor torque is given by $T = Ki$ this becomes

$$Ki = J\ddot{\theta} + F\dot{\theta}$$

The equation for the motor armature circuit is

$$v = Ri + L di / dt + K\dot{\theta}$$

where $K\dot{\theta}$ is the back emf.

Taking Laplace transforms of the last two equations and with some rearrangement one obtains

$$KI = Js^2\theta + Fs\theta$$

$$I = (V - Ks\theta)/(R + sL)$$

**STUDY FOR YOUR MASTER'S DEGREE
IN THE CRADLE OF SWEDISH ENGINEERING**

Chalmers University of Technology conducts research and education in engineering and natural sciences, architecture, technology-related mathematical sciences and nautical sciences. Behind all that Chalmers accomplishes, the aim persists for contributing to a sustainable future – both nationally and globally.

Visit us on **Chalmers.se** or **Next Stop Chalmers** on facebook.

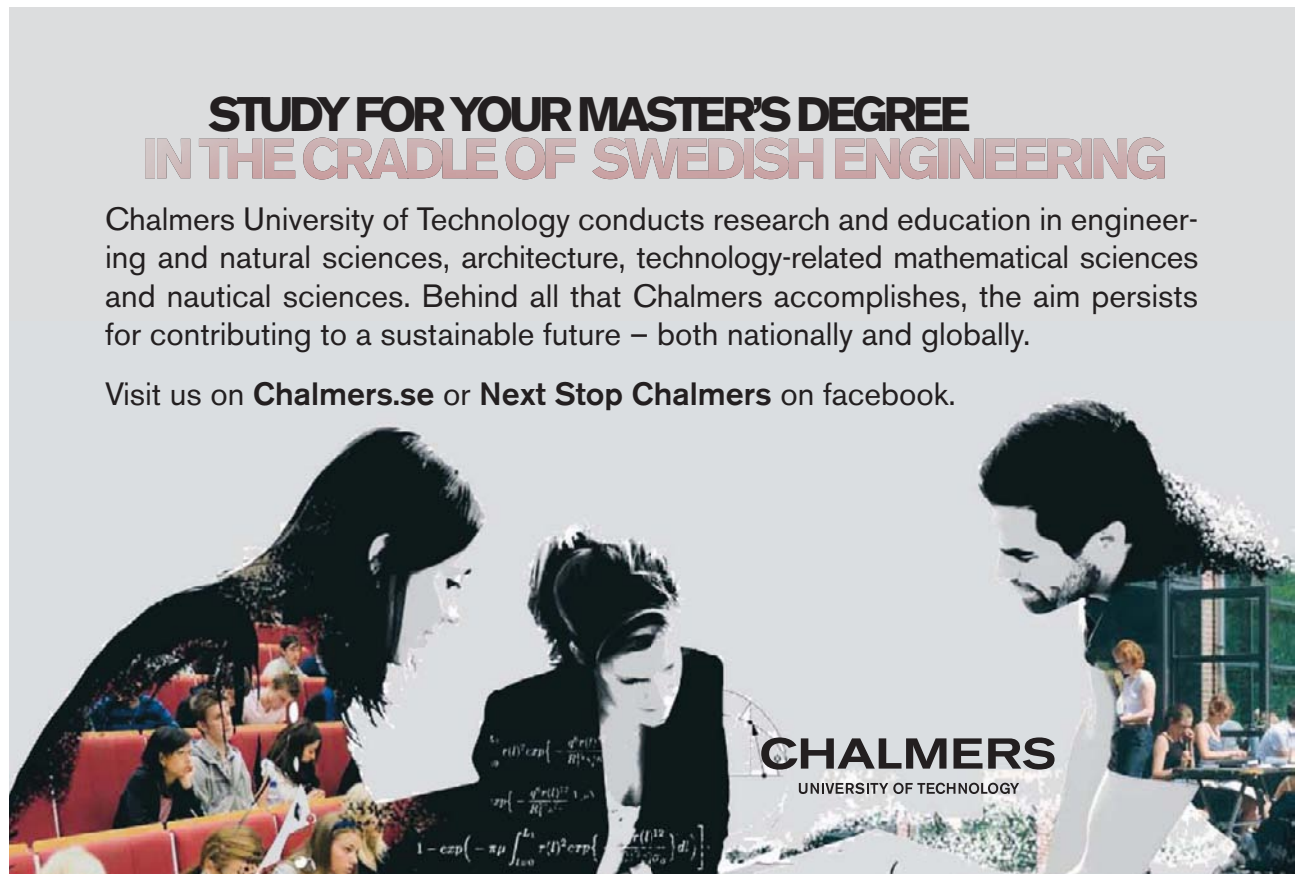

CHALMERS
UNIVERSITY OF TECHNOLOGY

which on eliminating I gives the transfer function

$$\frac{\theta}{V} = \frac{K}{s^3 LJ + s^2(RJ + LF) + s(K^2 + RF)}$$

Thus if this is put into the controllable canonical form state space representation with state vector $x = (\theta \quad \dot{\theta} \quad \ddot{\theta})^T$, then the matrices are

$$A_c = \begin{pmatrix} 0 & 1 & 0 \\ 0 & 0 & 1 \\ 0 & -(K^2 + FR)/LJ & -(RJ + LF)/LJ \end{pmatrix}, B_c = \begin{pmatrix} 0 \\ 0 \\ K/LJ \end{pmatrix}, C_c = (1 \quad 0 \quad 0) \text{ and } D = 0$$

Alternatively, for the state vector of $z = (\theta \quad \dot{\theta} \quad i)^T$ one has, by choice,

$$\dot{z}_1 = z_2$$

and from the two equations for which the Laplace transforms were taken above

$$Kz_3 = J\dot{z}_2 + Fz_2$$

$$v = Rz_3 + L\dot{z}_3 + Kz_2$$

These three equations give the state space representation

$$A = \begin{pmatrix} 0 & 1 & 0 \\ 0 & -F/J & K/J \\ 0 & -K/L & -R/L \end{pmatrix}, B = \begin{pmatrix} 0 \\ 0 \\ 1/L \end{pmatrix}, C = (1 \quad 0 \quad 0) \text{ and } D = 0$$

It can be easily seen that $\det(A_c) = \det(A) = 0$, $\text{trace}(A_c) = \text{trace}(A) = -\left\{\frac{R}{L} + \frac{F}{J}\right\}$ and the characteristic equation for both A_c and A is $s^3 LJ + s^2(RJ + LF) + s(K^2 + RF) = 0$. In many cases L can be neglected and the resulting transfer function is

$$\frac{\theta}{V} = \frac{K}{s^2 RJ + s(RF + K^2)} = \frac{K/RJ}{s(s + [RF + K^2]/RJ)} = \frac{K_m}{s(s + a)}$$

where $K_m = K/RJ$ and $a = (RF + K^2)/RJ$. The corresponding state space representation is

$$A = \begin{pmatrix} 0 & 1 \\ 0 & -a \end{pmatrix}, B = \begin{pmatrix} 0 \\ 1 \end{pmatrix} \text{ and } C = (K_m \quad 0)$$

Example 6.2

For the transfer functions

$$\text{a) } G(s) = \frac{s+2}{(s+1)(s+3)}$$

$$\text{b) } G(s) = \frac{s^2 + 2s + 3}{s^3 + 7s^2 + 14s + 8}$$

Determine

- i. The controllable canonical form state space representation.
- ii. A diagonal form state space representation.

Use Matlab to check your result in (ii) and also find the companion form of Matlab and compare it with your result in (i)

(a)

(i) For $G(s) = \frac{s+2}{(s+1)(s+3)} = \frac{s+2}{s^2+4s+3}$. Thus in controllable canonical form, using the subscript c , one has

$$A_c = \begin{pmatrix} 0 & 1 \\ -3 & -4 \end{pmatrix}, B_c = \begin{pmatrix} 0 \\ 1 \end{pmatrix}, C_c = (2 \quad 1) \text{ and } D_c = 0.$$

(ii) Putting $G(s)$ into partial fractions gives $G(s) = \frac{0.5}{s+1} + \frac{0.5}{s+3}$ which has a state space representation

of $A_\Lambda = \begin{pmatrix} -1 & 0 \\ 0 & -3 \end{pmatrix}$, $B_\Lambda = \begin{pmatrix} b_1 \\ b_2 \end{pmatrix}$, $C_\Lambda = (c_1 \quad c_2)$, $D_\Lambda = 0$. The choices for B_Λ and C_Λ are arbitrary as the only requirement is that $b_1c_1 = b_2c_2 = 0.5$, whilst also the eigenvalues on the diagonal of A_Λ could

be interchanged. Typically one chooses either $b_1 = b_2 = 1$ or $c_1 = c_2 = 1$. A typical solution would

therefore be $A_\Lambda = \begin{pmatrix} -1 & 0 \\ 0 & -3 \end{pmatrix}$, $B_\Lambda = \begin{pmatrix} 1 \\ 1 \end{pmatrix}$, $C_\Lambda = (0.5 \quad 0.5)$, $D_\Lambda = 0$.

To obtain the diagonal form using Matlab the command is `canon(G,'modal')` and because of the various alternative solutions the representation returned by Matlab may differ according to the entry form used for G . In this case when the system was entered as the transfer function the result was $A_\Lambda = \begin{pmatrix} -3 & 0 \\ 0 & -1 \end{pmatrix}$, $B_\Lambda = \begin{pmatrix} -3.606 \\ -2.236 \end{pmatrix}$, $C_\Lambda = (-0.1387 \quad -0.2236)$, $D_\Lambda = 0$, and when entered as the controllable canonical form it was $A_\Lambda = \begin{pmatrix} -1 & 0 \\ 0 & -3 \end{pmatrix}$, $B_\Lambda = \begin{pmatrix} -0.7071 \\ 1.581 \end{pmatrix}$, $C_\Lambda = (0.7071 \quad 0.3162)$, $D_\Lambda = 0$. For both entry forms the companion form returned by Matlab was $A_{cm} = \begin{pmatrix} 0 & -3 \\ 1 & -4 \end{pmatrix}$, $B_{cm} = \begin{pmatrix} 1 \\ 0 \end{pmatrix}$, $C_{cm} = (1 \quad -2)$, $D_{cm} = 0$. It is seen that A_{cm} is equal to A_c^T and the unity value in B_{cm} occurs in the first element not the last as with B_c . If the command `[csys,V]=canon(G,'companion')` is entered into Matlab the transformation matrix V , which satisfies $VAV^{-1} = A_{cm}$ is obtained.

(b)

(i) For $G(s) = \frac{s^2 + 2s + 3}{s^3 + 7s^2 + 14s + 8}$ the controllable canonical form is $A_c = \begin{pmatrix} 0 & 1 & 0 \\ 0 & 0 & 1 \\ -8 & -14 & -7 \end{pmatrix}$,
 $B_c = \begin{pmatrix} 0 \\ 0 \\ 1 \end{pmatrix}$, $C_c = (3 \quad 2 \quad 1)$ and $D_c = 0$.

Scholarships

Open your mind to new opportunities

With 31,000 students, Linnaeus University is one of the larger universities in Sweden. We are a modern university, known for our strong international profile. Every year more than 1,600 international students from all over the world choose to enjoy the friendly atmosphere and active student life at Linnaeus University. Welcome to join us!

Linnaeus University
Sweden

Ln.u.se

Bachelor programmes in
Business & Economics | Computer Science/IT | Design | Mathematics

Master programmes in
Business & Economics | Behavioural Sciences | Computer Science/IT | Cultural Studies & Social Sciences | Design | Mathematics | Natural Sciences | Technology & Engineering

Summer Academy courses

(ii) Expanding in partial fractions gives $G(s) = \frac{2/3}{s+1} - \frac{3/2}{s+2} + \frac{11/6}{s+4}$ so that one diagonal representation is $A_\Lambda = \begin{pmatrix} -1 & 0 & 0 \\ 0 & -2 & 0 \\ 0 & 0 & -4 \end{pmatrix}$, $B_\Lambda = \begin{pmatrix} 1 \\ 1 \\ 1 \end{pmatrix}$, $C_\Lambda = (2/3 \quad -3/2 \quad 11/6)$ and $D_\Lambda = 0$.

One modal representation given by Matlab is $A_\Lambda = \begin{pmatrix} -4 & 0 & 0 \\ 0 & -2 & 0 \\ 0 & 0 & -1 \end{pmatrix}$, $B_\Lambda = \begin{pmatrix} -7.659 \\ -9.798 \\ 3.83 \end{pmatrix}$, $C_\Lambda = (-0.2394 \quad -0.1531 \quad 0.1741)$ and $D_\Lambda = 0$ and the companion representation is

$$A_{cm} = \begin{pmatrix} 0 & 0 & -8 \\ 1 & 0 & -14 \\ 0 & 1 & -7 \end{pmatrix}, B_{cm} = \begin{pmatrix} 1 \\ 0 \\ 0 \end{pmatrix}, C_{cm} = (1 \quad -5 \quad 24) \text{ and } D_{cm} = 0.$$

Again $A_{cm} = A_c^T$ and the unity value in B_{cm} occurs in the first element.

Example 6.3

Obtain an upper triangular state space representation form for the transfer function $G(s) = \frac{s+2}{(s+1)(s+4)}$.

The transfer function can be written as the two cascaded transfer functions $G_2(s) = \frac{s+2}{s+1}$ and $G_1(s) = \frac{1}{s+4}$. A state space representation for the first transfer function with input u and output z , considering it as $G_2(s) = 1 + \frac{1}{s+1}$ is $\dot{x}_2 = u - x_2$, $z = u + x_2$ and for the second, with input z and output y is $\dot{x}_1 = -4x_1 + z$, $y = x_1$. Substituting for z gives $\dot{x}_1 = -4x_1 + x_2 + u$, and also $y = x_1$, so that $A_g = \begin{pmatrix} -4 & 1 \\ 0 & -1 \end{pmatrix}$, $B_g = \begin{pmatrix} 1 \\ 1 \end{pmatrix}$, $C_g = (1 \quad 0)$, and $D_g = 0$. Obviously this is not unique as one could alternatively separate $G(s)$ into $G_2(s) = \frac{1}{s+1}$ and $G_1(s) = \frac{s+2}{s+4}$.

Example 6.4

For the following state space descriptions calculate the eigenvalues and eigenvectors of the A matrix and give an equivalent state space representation in terms of a diagonal (modal) form of the A matrix. State whether the representations are controllable and observable and give the transfer functions. Check the calculations using Matlab.

$$\text{a) } A = \begin{pmatrix} -5 & -1 \\ 2 & -2 \end{pmatrix}, B = \begin{pmatrix} 1 \\ 2 \end{pmatrix}, C = (1 \quad 2), D = 0.$$

$$\text{b) } A = \begin{pmatrix} -5 & 4 \\ -1 & 0 \end{pmatrix}, B = \begin{pmatrix} 1 \\ 1 \end{pmatrix}, C = (1 \ 2), D = 0.$$

$$\text{c) } A = \begin{pmatrix} -5 & 1 & -1 \\ -4 & -1 & -2 \\ 4 & -1 & 0 \end{pmatrix}, B = \begin{pmatrix} 2 \\ 3 \\ -1 \end{pmatrix}, C = (4 \ -1 \ 2), D = 0$$

$$\text{d) } A = \begin{pmatrix} -15 & -16 & -8 \\ 15 & 17 & 10 \\ -16 & -17 & -8 \end{pmatrix}, B = \begin{pmatrix} 1 \\ -1 \\ 1 \end{pmatrix}, C = (1 \ 0 \ 1), D = 0$$

(a) For this case $sI - A = \begin{pmatrix} s+5 & 1 \\ -2 & s+2 \end{pmatrix}$, which has the characteristic equation $s^2 + 7s + 12 = 0$,

with eigenvalues -3 and -4 . Taking s equal to -3 the first eigenvector is given by

$$-3I - A = \begin{pmatrix} -3+5 & 1 \\ -2 & -3+2 \end{pmatrix} = \begin{pmatrix} 2 & 1 \\ -2 & -1 \end{pmatrix} \begin{pmatrix} t_{11} \\ t_{21} \end{pmatrix} = 0 \text{ so that one can take } \begin{pmatrix} t_{11} \\ t_{21} \end{pmatrix} = \begin{pmatrix} 1 \\ -2 \end{pmatrix} \text{ and for } s \text{ equal}$$

to -4 the other eigenvector is given by $-4I - A = \begin{pmatrix} -4+5 & 1 \\ -2 & -4+2 \end{pmatrix} = \begin{pmatrix} 1 & 1 \\ -2 & -2 \end{pmatrix} \begin{pmatrix} t_{12} \\ t_{22} \end{pmatrix} = 0$ so that

one can take $\begin{pmatrix} t_{12} \\ t_{22} \end{pmatrix} = \begin{pmatrix} 1 \\ -1 \end{pmatrix}$ and the transformation matrix $T = \begin{pmatrix} 1 & 1 \\ -2 & -1 \end{pmatrix}$. Thus $T^{-1} = \begin{pmatrix} -1 & -1 \\ 2 & 1 \end{pmatrix}$

and $A_\Lambda = T^{-1}AT = \begin{pmatrix} -1 & -1 \\ 2 & 1 \end{pmatrix} \begin{pmatrix} -5 & -1 \\ 2 & -2 \end{pmatrix} \begin{pmatrix} 1 & 1 \\ -2 & -1 \end{pmatrix} = \begin{pmatrix} -3 & 0 \\ 0 & -4 \end{pmatrix}$, $B_\Lambda = \begin{pmatrix} -1 & -1 \\ 2 & 1 \end{pmatrix} \begin{pmatrix} 1 \\ 2 \end{pmatrix} = \begin{pmatrix} -3 \\ 4 \end{pmatrix}$ and

$C_\Lambda = (1 \ 2) \begin{pmatrix} 1 & 1 \\ -2 & -1 \end{pmatrix} = (-3 \ -1)$. Since neither B_Λ or C_Λ contain a zero term the representation is

controllable and observable and its transfer function is $\frac{5s + 24}{s^2 + 7s + 12}$. After entering the state space

description of G into Matlab then in response to the following command one obtains

```
>> [T,D]=eig(A)
T =
   -0.7071    0.4472
    0.7071   -0.8944
D =
   -4    0
    0   -3
```

Here T is the transformation matrix and it is seen that the eigenvectors (after allowing for scaling) are in the reverse order and so therefore are the eigenvalues in the D matrix. Alternatively if the following commands are used the modal form is given directly together with the transformation matrix which is the inverse of T .

```

>> [Gd,V]=canon(G,'modal')
a =
      x1      x2
x1 -4         0
x2  0        -3
b =
      u1
x1 -5.657
x2 -6.708
c =
      x1      x2
y1 0.7071 -1.342
d =
      u1
y1  0
Continuous-time model.
V =
-2.8284  -1.4142
-2.2361  -2.2361
>> T=inv(V)
T =
-0.7071    0.4472
 0.7071   -0.8944

```

This state space description yields the same transfer function allowing for rounding errors, which can also be found from the command `tf(Gd)`.

(b) For this case $sI - A = \begin{pmatrix} s+5 & -4 \\ 1 & s \end{pmatrix}$, which has the characteristic equation $s^2 + 5s + 4 = 0$, with eigenvalues -1 and -4 . For the eigenvectors $(s_i I - A)t_i = 0$ gives for the two values of s $t_1 = (1 \ 1)^T$ and $t_2 = (4 \ 1)^T$ to give $T = \begin{pmatrix} 1 & 4 \\ 1 & 1 \end{pmatrix}$. This gives $T^{-1}AT = \begin{pmatrix} -1/3 & 4/3 \\ 1/3 & -1/3 \end{pmatrix} \begin{pmatrix} -5 & 4 \\ -1 & 0 \end{pmatrix} \begin{pmatrix} 1 & 4 \\ 1 & 1 \end{pmatrix} = \begin{pmatrix} -1 & 0 \\ 0 & -4 \end{pmatrix} = A_\lambda$ as expected. $B_\lambda = \begin{pmatrix} -1/3 & 4/3 \\ 1/3 & -1/3 \end{pmatrix} \begin{pmatrix} 1 \\ 1 \end{pmatrix} = \begin{pmatrix} 1 \\ 0 \end{pmatrix}$ and $C_\lambda = (1 \ 2) \begin{pmatrix} 1 & 4 \\ 1 & 1 \end{pmatrix} = (3 \ 6)$. Thus due to the zero in B_λ the second mode -4 is not controllable and the transfer function is $\frac{3}{s+1}$. Using the command

`Gd=canon(G,'modal')` in Malab the response is

a =

$$\begin{array}{cc} & \begin{array}{cc} x1 & x2 \end{array} \\ \begin{array}{c} x1 \\ x2 \end{array} & \begin{array}{cc} -4 & 0 \\ 0 & -1 \end{array} \end{array}$$

b =

$$\begin{array}{c} \begin{array}{c} u1 \\ x1 \\ x2 \end{array} \\ \begin{array}{c} 0 \\ -1.414 \end{array} \end{array}$$

c =

$$\begin{array}{cc} & \begin{array}{cc} x1 & x2 \end{array} \\ \begin{array}{c} y1 \end{array} & \begin{array}{cc} -1.455 & -2.121 \end{array} \end{array}$$

d =

$$\begin{array}{c} \begin{array}{c} u1 \\ y1 \end{array} \\ \begin{array}{c} 0 \end{array} \end{array}$$

From which it can be seen that the transfer function is $3/(s+1)$ and the mode at -4 is uncontrollable as the first element of the B vector is zero. The response in Matlab to `tf(G)` is

Transfer function:

$$3s + 12$$

$$s^2 + 5s + 4$$

which on cancelling the $s+4$ factor gives $3/(s+1)$. Alternatively for the following commands the reduced model is obtained.

```
>> Gm=minreal(G)
```

1 state removed.

a =

```
      x1
x1  -1
```

b =

```
      u1
x1  1.414
```

c =

```
      x1
y1  2.121
```

d =

```
      u1
y1   0
```

Continuous-time model.

```
>> tf(Gm)
```

Transfer function:

```
3
```

```
----
```

```
s + 1
```

(c) For this system $sI - A = \begin{pmatrix} s+5 & -1 & 1 \\ 4 & s+1 & 2 \\ -4 & 1 & s \end{pmatrix}$ which gives the characteristic equation $s^3 + 6s^2 + 11s + 6 = 0$,

which has eigenvalues of -1, -2 and -3. The corresponding eigenvectors from $(s_i I - A)t_i = 0$ can be

calculated as $t_1 = (1 \ 2 \ -2)^T$, $t_2 = (1 \ 2 \ -1)^T$ and $t_3 = (1 \ 1 \ -1)^T$. Thus $T = \begin{pmatrix} 1 & 1 & 1 \\ 2 & 2 & 1 \\ -2 & -1 & -1 \end{pmatrix}$ giving

$T^{-1} = \begin{pmatrix} -1 & 0 & -1 \\ 0 & 1 & 1 \\ 2 & -1 & 0 \end{pmatrix}$ so that calculations give $T^{-1}AT = \begin{pmatrix} -1 & 0 & 0 \\ 0 & -2 & 0 \\ 0 & 0 & -3 \end{pmatrix}$, $T^{-1}B = \begin{pmatrix} -1 \\ 2 \\ 1 \end{pmatrix}$ and $CT = (-2 \ 0 \ 1)$. Thus

it can be seen that the mode at -2 is unobservable and the transfer function is $\frac{2}{s+1} + \frac{1}{s+3} = \frac{3s+7}{s^2+4s+3}$.



e-learning for kids

- The number 1 MOOC for Primary Education
- Free Digital Learning for Children 5-12
- 15 Million Children Reached

About e-Learning for Kids Established in 2004, e-Learning for Kids is a global nonprofit foundation dedicated to fun and free learning on the Internet for children ages 5 - 12 with courses in math, science, language arts, computers, health and environmental skills. Since 2005, more than 15 million children in over 190 countries have benefitted from eLessons provided by EFK! An all-volunteer staff consists of education and e-learning experts and business professionals from around the world committed to making difference. eLearning for Kids is actively seeking funding, volunteers, sponsors and courseware developers; get involved! For more information, please visit www.e-learningforkids.org.

Using Matlab gives

```
>> [Gd,V]=canon(G,'modal')
```

a =

	x1	x2	x3
x1	-3	0	0
x2	0	-1	0
x3	0	0	-2

b =

	u1
x1	-1.732
x2	-3
x3	4.899

c =

	x1	x2	x3
y1	-0.5774	-0.6667	1.11e-016

d =

	u1
y1	0

Continuous-time model.

V =

-3.4641	1.7321	-0.0000
-3.0000	0.0000	-3.0000
0.0000	2.4495	2.4495

```
>> T=inv(V)
```

```
T =
```

```

    -0.5774    0.3333    0.4082
    -0.5774    0.6667    0.8165
     0.5774   -0.6667   -0.4082

```

```
>> tf(Gd)
```

```
Transfer function:
```

```
3 s^2 + 13 s + 14
```

```
-----
```

```
s^3 + 6 s^2 + 11 s + 6
```

The essentially zero term in the last element of C shows that the -2 mode is unobservable and the transfer function is equal to $\frac{3s+7}{s^2+4s+3}$ when the common factor of $s+2$ is cancelled

(d) For the system $A = \begin{pmatrix} -15 & -16 & -8 \\ 15 & 17 & 10 \\ -16 & -17 & -8 \end{pmatrix}$, $B = \begin{pmatrix} 1 \\ -1 \\ 1 \end{pmatrix}$, $C = (1 \ 0 \ 1)$, $D = 0$, the characteristic equation

is $\begin{vmatrix} s+15 & 16 & 8 \\ -15 & s-17 & -10 \\ 16 & 17 & s+8 \end{vmatrix} = 0$, which on multiplying out gives $s^3 + 6s^2 + 11s + 6 = 0$, which has roots

of -1, -2 and -3. Hand calculation of the eigenvectors with the above numbers in the A matrix is laborious so going straight to Matlab gives Continuous-time model.

```
>> [Gd,V]=canon(G,'modal')
```

a =

	x1	x2	x3
x1	-3	0	0
x2	0	-2	0
x3	0	0	-1

b =

	u1
x1	-12.79
x2	14.59
x3	-3.536

c =

	x1	x2	x3
y1	-1.056	-1.028	-0.9899

d =

	u1
y1	0

Continuous-time model.

V =

-63.9336	-51.1468	0.0000
102.1616	72.9726	-14.5945
-38.8909	-21.2132	14.1421

From this modal representation it can be seen that the system is controllable and observable and further

```
>> T=inv(V)
```

T =

-0.5474	-0.5482	-0.5657
0.6648	0.6852	0.7071
-0.5083	-0.4796	-0.4243,

and

```
>>tf(Gd)
```

Transfer function:

$$2 s^2 - 2 s + 3$$

$$s^3 + 6 s^2 + 11 s + 6$$

.....Alcatel-Lucent 

www.alcatel-lucent.com/careers

What if you could build your future and create the future?

One generation's transformation is the next's status quo. In the near future, people may soon think it's strange that devices ever had to be "plugged in." To obtain that status, there needs to be "The Shift".



Example 6.5

For the state space descriptions (a), (b) and (c) of example 6.4 calculate the transfer function and the state transition matrix by

- i) The inverse Laplace transform method
- ii) The diagonalisation method
- iii) The Cayley Hamilton theorem.

(a) For this case $sI - A = \begin{pmatrix} s+5 & 1 \\ -2 & s+2 \end{pmatrix}$ and $(sI - A)^{-1} = \begin{pmatrix} \frac{s+2}{(s+3)(s+4)} & \frac{-1}{(s+3)(s+4)} \\ \frac{2}{(s+3)(s+4)} & \frac{s+5}{(s+3)(s+4)} \end{pmatrix}$.

(i) The transfer function is $(1 \ 2) \begin{pmatrix} \frac{s+2}{(s+3)(s+4)} & \frac{-1}{(s+3)(s+4)} \\ \frac{2}{(s+3)(s+4)} & \frac{s+5}{(s+3)(s+4)} \end{pmatrix} \begin{pmatrix} 1 \\ 2 \end{pmatrix} = \frac{5s+24}{(s+3)(s+4)}$ and putting each term of $(sI - A)^{-1}$ into partial fractions and taking inverse Laplace transforms gives

$$\varphi(t) = e^{At} = \begin{pmatrix} -e^{-3t} + 2e^{-4t} & -e^{-3t} + e^{-4t} \\ 2e^{-3t} - 2e^{-4t} & 2e^{-3t} - e^{-4t} \end{pmatrix}.$$

(ii) Using the diagonalizing T matrix found earlier gives

$$Te^{At}T^{-1} = \begin{pmatrix} 1 & 1 \\ -2 & -1 \end{pmatrix} \begin{pmatrix} e^{-3t} & 0 \\ 0 & e^{-4t} \end{pmatrix} \begin{pmatrix} -1 & -1 \\ 2 & 1 \end{pmatrix} = \begin{pmatrix} -e^{-3t} + 2e^{-4t} & -e^{-3t} + e^{-4t} \\ 2e^{-3t} - 2e^{-4t} & 2e^{-3t} - e^{-4t} \end{pmatrix} \text{ as before.}$$

(iii) From use of the Cayley-Hamilton theorem one has $e^{At} = \alpha_0 I + \alpha_1 A$ and $e^{s_i t} = \alpha_0 + \alpha_1 s_i$ which yields $e^{-3t} = \alpha_0 - 3\alpha_1$ and $e^{-4t} = \alpha_0 - 4\alpha_1$ giving $\alpha_0 = 4e^{-3t} - 3e^{-4t}$ and $\alpha_1 = e^{-3t} - e^{-4t}$, thus again

$$e^{At} = \begin{pmatrix} 4e^{-3t} - 3e^{-4t} & 0 \\ 0 & 4e^{-3t} - 3e^{-4t} \end{pmatrix} + \begin{pmatrix} -5e^{-3t} + 5e^{-4t} & -e^{-3t} + e^{-4t} \\ 2e^{-3t} - 2e^{-4t} & -2e^{-3t} + 2e^{-4t} \end{pmatrix} = \begin{pmatrix} -e^{-3t} + 2e^{-4t} & -e^{-3t} + e^{-4t} \\ 2e^{-3t} - 2e^{-4t} & 2e^{-3t} - e^{-4t} \end{pmatrix}$$

(b) For this case $sI - A = \begin{pmatrix} s+5 & -4 \\ 1 & s \end{pmatrix}$ and $(sI - A)^{-1} = \begin{pmatrix} \frac{s}{(s+1)(s+4)} & \frac{4}{(s+1)(s+4)} \\ \frac{-1}{(s+1)(s+4)} & \frac{s+5}{(s+1)(s+4)} \end{pmatrix}$.

(i) The transfer function is $(1 \ 2) \begin{pmatrix} \frac{s}{(s+1)(s+4)} & \frac{4}{(s+1)(s+4)} \\ \frac{-1}{(s+1)(s+4)} & \frac{s+5}{(s+1)(s+4)} \end{pmatrix} \begin{pmatrix} 1 \\ 1 \end{pmatrix} = \frac{3s+12}{(s+1)(s+4)} = \frac{3}{s+1}$ and

putting each term of $(sI - A)^{-1}$ into partial fractions and taking inverse Laplace transforms gives $\varphi(t) = e^{At} = (1/3) * \begin{pmatrix} -e^{-t} + 4e^{-4t} & 4e^{-t} - 4e^{-4t} \\ -e^{-t} + e^{-4t} & 4e^{-t} - e^{-4t} \end{pmatrix}$.

(ii) Using the diagonalizing T matrix found earlier gives

$$Te^{At}T^{-1} = (1/3) * \begin{pmatrix} 1 & 4 \\ 1 & 1 \end{pmatrix} \begin{pmatrix} e^{-t} & 0 \\ 0 & e^{-4t} \end{pmatrix} \begin{pmatrix} -1 & 4 \\ 1 & -1 \end{pmatrix} = (1/3) * \begin{pmatrix} -e^{-t} + 4e^{-4t} & 4e^{-t} - 4e^{-4t} \\ -e^{-t} + e^{-4t} & 4e^{-t} - e^{-4t} \end{pmatrix} \text{ as before.}$$

(iii) From use of the Cayley-Hamilton theorem one has $e^{At} = \alpha_0 I + \alpha_1 A$ and $e^{s_i t} = \alpha_0 + \alpha_1 s_i$ which yields $e^{-t} = \alpha_0 - \alpha_1$ and $e^{-4t} = \alpha_0 - 4\alpha_1$ giving $\alpha_0 = (4/3)e^{-t} - (1/3)e^{-4t}$ and $\alpha_1 = (1/3)e^{-t} - (1/3)e^{-4t}$, thus again

$$3e^{At} = \begin{pmatrix} 4e^{-t} - e^{-4t} & 0 \\ 0 & 4e^{-t} - e^{-4t} \end{pmatrix} + \begin{pmatrix} -5e^{-t} + 5e^{-4t} & 4e^{-t} - 4e^{-4t} \\ -e^{-t} + e^{-4t} & 0 \end{pmatrix} = \begin{pmatrix} -e^{-t} + 4e^{-4t} & 4e^{-t} - 4e^{-4t} \\ -e^{-t} + e^{-4t} & 4e^{-t} - e^{-4t} \end{pmatrix}$$

(c) For this case $sI - A = \begin{pmatrix} s+5 & -1 & 1 \\ 4 & s+1 & 2 \\ -4 & 1 & s \end{pmatrix}$ and

$$(sI - A)^{-1} = \left[\frac{1}{(s+1)(s+2)(s+3)} \begin{pmatrix} s^2 + s - 2 & -4s - 8 & 4s + 8 \\ s + 1 & s^2 + 5s + 4 & -s - 1 \\ -s - 3 & -2s - 6 & s^2 + 6s + 9 \end{pmatrix} \right]^T$$

$$= \begin{pmatrix} \frac{s-1}{(s+1)(s+3)} & \frac{1}{(s+2)(s+3)} & \frac{-1}{(s+1)(s+2)} \\ \frac{-4}{(s+1)(s+3)} & \frac{s+4}{(s+2)(s+3)} & \frac{-2}{(s+1)(s+2)} \\ \frac{4}{(s+1)(s+3)} & \frac{-1}{(s+2)(s+3)} & \frac{s+3}{(s+1)(s+2)} \end{pmatrix}$$

The transfer function is

$$C(sI - A)^{-1}B =$$

$$(4 \quad -1 \quad 2) \begin{pmatrix} \frac{s-1}{(s+1)(s+3)} & \frac{1}{(s+2)(s+3)} & \frac{-1}{(s+1)(s+2)} \\ -4 & \frac{1}{s+4} & -2 \\ \frac{(s+1)(s+3)}{4} & \frac{(s+2)(s+3)}{-1} & \frac{(s+1)(s+2)}{s+3} \\ \frac{(s+1)(s+3)}{(s+1)(s+3)} & \frac{(s+2)(s+3)}{(s+2)(s+3)} & \frac{(s+1)(s+2)}{(s+1)(s+2)} \end{pmatrix} \begin{pmatrix} 2 \\ 3 \\ -1 \end{pmatrix} =$$

$$(4 \quad -1 \quad 2) \begin{pmatrix} \frac{8s^2 + 24s + 8}{s^3 + 6s^2 + 1} & \frac{s+6}{s+6} \\ \frac{-3s^2 - 9s - 2}{s^3 + 6s^2 + 1} & \frac{s+6}{s+6} \\ \frac{s^3 + 6s^2 + 1}{s^3 + 6s^2 + 1} & \frac{s+6}{s+6} \\ \frac{-2s^2 - 2s + 8}{s^3 + 6s^2 + 1} & \frac{s+6}{s+6} \end{pmatrix} = \frac{3s^2 + 13s + 14}{(s+1)(s+2)(s+3)} = \frac{3s+7}{(s+1)(s+3)}$$

$$\text{and } e^{At} = \begin{pmatrix} -e^{-t} + 2e^{-3t} & e^{-2t} - e^{-3t} & -e^{-t} + e^{-2t} \\ -2e^{-t} + 2e^{-3t} & 2e^{-2t} - e^{-3t} & -2e^{-t} + 2e^{-2t} \\ 2e^{-t} - 2e^{-3t} & -e^{-2t} + e^{-3t} & 2e^{-t} - e^{-2t} \end{pmatrix}$$



Nido

Luxurious accommodation

Central zone 1 & 2 locations

Meet hundreds of international students

BOOK NOW and get a £100 voucher from voucherexpress

Nido Student Living - London

Visit www.NidoStudentLiving.com/Bookboon for more info.

+44 (0)20 3102 1060

(ii) Using the diagonalizing T matrix found earlier gives

$$Te^{At}T^{-1} = \begin{pmatrix} 1 & 1 & 1 \\ 2 & 2 & 1 \\ -2 & -1 & -1 \end{pmatrix} \begin{pmatrix} e^{-t} & 0 & 0 \\ 0 & e^{-2t} & 0 \\ 0 & 0 & e^{-3t} \end{pmatrix} \begin{pmatrix} -1 & 0 & -1 \\ 0 & 1 & 1 \\ 2 & -1 & 0 \end{pmatrix} = \begin{pmatrix} 1 & 1 & 1 \\ 2 & 2 & 1 \\ -2 & -1 & -1 \end{pmatrix} \begin{pmatrix} -e^{-t} & 0 & -e^{-t} \\ 0 & e^{-2t} & e^{-2t} \\ 2e^{-3t} & -e^{-3t} & 0 \end{pmatrix} =$$

$$\begin{pmatrix} -e^{-t} + 2e^{-3t} & e^{-2t} - e^{-3t} & -e^{-t} + e^{-2t} \\ -2e^{-t} + 2e^{-3t} & 2e^{-2t} - e^{-3t} & -2e^{-t} + 2e^{-2t} \\ 2e^{-t} - 2e^{-3t} & -e^{-2t} + e^{-3t} & 2e^{-t} - e^{-2t} \end{pmatrix}$$

as before.

(iii) From use of the Cayley-Hamilton theorem one has $e^{At} = \alpha_0 I + \alpha_1 A + \alpha_2 A^2$ and $e^{s_i t} = \alpha_0 + \alpha_1 s_i + \alpha_2 s_i^2$. Substituting the eigenvalues in the latter equation gives the three equations $e^{-t} = \alpha_0 - \alpha_1 + \alpha_2$, $e^{-2t} = \alpha_0 - 2\alpha_1 + 4\alpha_2$ and $e^{-3t} = \alpha_0 - 3\alpha_1 + 9\alpha_2$. These give solutions for the alphas of $\alpha_0 = 3e^{-t} - 3e^{-2t} + e^{-3t}$, $\alpha_1 = 2.5e^{-t} - 4e^{-2t} + 1.5e^{-3t}$ and

$$\alpha_2 = 0.5e^{-t} - e^{-2t} + 0.5e^{-3t}. \text{ Now } A^2 = \begin{pmatrix} -5 & 1 & -1 \\ -4 & -1 & -2 \\ 4 & -1 & 0 \end{pmatrix} \begin{pmatrix} -5 & 1 & -1 \\ -4 & -1 & -2 \\ 4 & -1 & 0 \end{pmatrix} = \begin{pmatrix} 17 & -5 & 3 \\ 16 & -1 & 6 \\ -16 & 5 & -2 \end{pmatrix},$$

so substituting the alphas in the matrix equation gives

$$e^{At} = \begin{pmatrix} 3e^{-t} - 3e^{-2t} + e^{-3t} & 0 & 0 \\ 0 & 3e^{-t} - 3e^{-2t} + e^{-3t} & 0 \\ 0 & 0 & 3e^{-t} - 3e^{-2t} + e^{-3t} \end{pmatrix} +$$

$$\begin{pmatrix} -12.5e^{-t} + 20e^{-2t} - 7.5e^{-3t} & 2.5e^{-t} - 4e^{-2t} + 1.5e^{-3t} & -2.5e^{-t} + 4e^{-2t} - 1.5e^{-3t} \\ -10e^{-t} + 16e^{-2t} - 6e^{-3t} & -2.5e^{-t} + 4e^{-2t} - 1.5e^{-3t} & -5e^{-t} + 8e^{-2t} - 3e^{-3t} \\ 10e^{-t} - 16e^{-2t} + 6e^{-3t} & -2.5e^{-t} + 4e^{-2t} - 1.5e^{-3t} & 0 \end{pmatrix} +$$

$$\begin{pmatrix} 8.5e^{-t} - 17e^{-2t} + 8.5e^{-3t} & -2.5e^{-t} + 5e^{-2t} - 2.5e^{-3t} & 1.5e^{-t} - 3e^{-2t} + 1.5e^{-3t} \\ 8e^{-t} - 16e^{-2t} + 8e^{-3t} & -0.5e^{-t} + e^{-2t} - 0.5e^{-3t} & 3e^{-t} - 6e^{-2t} + 3e^{-3t} \\ -8e^{-t} + 16e^{-2t} - 8e^{-3t} & 2.5e^{-t} - 5e^{-2t} + 2.5e^{-3t} & -e^{-t} + 2e^{-2t} - e^{-3t} \end{pmatrix} =$$

$$\begin{pmatrix} -e^{-t} + 2e^{-3t} & e^{-2t} - e^{-3t} & -e^{-t} + e^{-2t} \\ -2e^{-t} + 2e^{-3t} & 2e^{-2t} - e^{-3t} & -2e^{-t} + 2e^{-2t} \\ 2e^{-t} - 2e^{-3t} & -e^{-2t} + e^{-3t} & 2e^{-t} - e^{-2t} \end{pmatrix}$$

as before.

Example 6.6

Use the controllability and observability theorems to check the results obtained for controllability and observability in Example 6.4.

(a) For this example $AB = \begin{pmatrix} -5 & -1 \\ 2 & -2 \end{pmatrix} \begin{pmatrix} 1 \\ 2 \end{pmatrix} = \begin{pmatrix} -7 \\ -2 \end{pmatrix}$ so that $(B \ AB) = \begin{pmatrix} 1 & -7 \\ 2 & -2 \end{pmatrix}$, the determinant of which is 12, so the system is controllable. Similarly $\begin{pmatrix} C \\ CA \end{pmatrix} = \begin{pmatrix} 1 & 2 \\ -1 & -5 \end{pmatrix}$, which has a determinant of -3, so the system is observable.

(b) For this example $(B \ AB) = \begin{pmatrix} 1 & -1 \\ 1 & -1 \end{pmatrix}$, which has a determinant of zero, so that the system is uncontrollable. The uncontrollable mode, however, is not revealed by this simple test. Similarly $\begin{pmatrix} C \\ CA \end{pmatrix} = \begin{pmatrix} 1 & 2 \\ -7 & 4 \end{pmatrix}$, which has a determinant of 18 so the system is observable.

(c) For this example $A = \begin{pmatrix} -5 & 1 & -1 \\ -4 & -1 & -2 \\ 4 & -1 & 0 \end{pmatrix}$ and $A^2 = \begin{pmatrix} 17 & -5 & 3 \\ 16 & -1 & 6 \\ -16 & 5 & -2 \end{pmatrix}$ so that

$(B \ AB \ A^2B) = \begin{pmatrix} 2 & -6 & 16 \\ -3 & -9 & 23 \\ 1 & 5 & -15 \end{pmatrix}$, which has a determinant of 4 so the system is controllable.

Similarly $\begin{pmatrix} C \\ CA \\ CA^2 \end{pmatrix} = \begin{pmatrix} 4 & -1 & 2 \\ -8 & 3 & -2 \\ 20 & -9 & 2 \end{pmatrix}$, which has a determinant of zero, so the system is unobservable.

(d) For this example $A = \begin{pmatrix} -15 & -16 & -8 \\ 15 & 17 & 10 \\ -16 & -17 & -8 \end{pmatrix}$ and

$A^2 = \begin{pmatrix} -15 & -16 & -8 \\ 15 & 17 & 10 \\ -16 & -17 & -8 \end{pmatrix} \begin{pmatrix} -15 & -16 & -8 \\ 15 & 17 & 10 \\ -16 & -17 & -8 \end{pmatrix} = \begin{pmatrix} 113 & 104 & 24 \\ -130 & -121 & -30 \\ 113 & 103 & 22 \end{pmatrix}$ so that

$(B \ AB \ A^2B) = \begin{pmatrix} 1 & -7 & 33 \\ -1 & 8 & 39 \\ 1 & -7 & 32 \end{pmatrix}$, which has a determinant of -1 so that the system is controllable.

Also $\begin{pmatrix} C \\ CA \\ CA^2 \end{pmatrix} = \begin{pmatrix} 1 & 0 & 1 \\ -31 & -33 & -16 \\ 226 & 207 & 46 \end{pmatrix}$, which has a determinant of 2835, so the system is observable.

Example 6.7

For the following three state space descriptions

$$(a) \quad A = \begin{pmatrix} -5 & -1 \\ 2 & -2 \end{pmatrix}, \quad B = \begin{pmatrix} 1 \\ 2 \end{pmatrix}, \quad C = (1 \quad 2), \quad D = 0. \quad x(0) = \begin{pmatrix} 2 \\ 1 \end{pmatrix}.$$

$$(b) \quad A = \begin{pmatrix} -5 & 4 \\ -1 & 0 \end{pmatrix}, \quad B = \begin{pmatrix} 1 \\ 1 \end{pmatrix}, \quad C = (1 \quad 2), \quad D = 0. \quad x(0) = \begin{pmatrix} 1 \\ 2 \end{pmatrix}.$$

$$(c) \quad A = \begin{pmatrix} -5 & 1 & -1 \\ -4 & -1 & -2 \\ 4 & -1 & 0 \end{pmatrix}, \quad B = \begin{pmatrix} 2 \\ 3 \\ -1 \end{pmatrix}, \quad C = (4 \quad -1 \quad 2), \quad D = 0. \quad x(0) = \begin{pmatrix} 1 \\ -1 \\ 2 \end{pmatrix}$$

determine the output for a unit step input at time zero and the initial conditions given using

- i) The s-domain approach.
- ii) The time domain approach.

SIMPLY CLEVER

ŠKODA



WE WILL TURN YOUR CV
INTO AN OPPORTUNITY
OF A LIFETIME

Do you like cars? Would you like to be a part of a successful brand?
As a constructor at ŠKODA AUTO you will put great things in motion. Things that will ease everyday lives of people all around Send us your CV. We will give it an entirely new new dimension.

Send us your CV on
www.employerforlife.com

(a)(i) In the s-domain the output $Y(s)$ is given by

$Y(s) = C(sI - A)^{-1}x(0) + C(sI - A)^{-1}BU(s) = C(sI - A)^{-1}x(0) + G(s)U(s)$. Using the values for this example gives

$$Y(s) = \begin{pmatrix} 1 & 2 \end{pmatrix} \begin{pmatrix} \frac{s+2}{(s+3)(s+4)} & \frac{-1}{(s+3)(s+4)} \\ \frac{2}{(s+3)(s+4)} & \frac{s+5}{(s+3)(s+4)} \end{pmatrix} \begin{pmatrix} 2 \\ 1 \end{pmatrix} + \frac{5s+24}{s(s+3)(s+4)} = \frac{4s+21}{(s+3)(s+4)} + \frac{5s+24}{s(s+3)(s+4)}$$

Putting into partial fractions gives $Y(s) = \frac{9}{s+3} - \frac{5}{s+4} + \frac{2}{s} - \frac{3}{s+3} + \frac{1}{s+4}$ which on inversion gives

$$y(t) = 2 + 6e^{-3t} - 4e^{-4t}.$$

(ii) In the time domain $y(t)$ can be evaluated from $y(t) = Ce^{At}x(0) + \int_0^t Ce^{A(t-\tau)}Bu(\tau)d\tau$. The first term is easily found and is equal to

$$\begin{pmatrix} 1 & 2 \end{pmatrix} \begin{pmatrix} -e^{-3t} + 2e^{-4t} & -e^{-3t} + e^{-4t} \\ 2e^{-3t} - 2e^{-4t} & 2e^{-3t} - e^{-4t} \end{pmatrix} \begin{pmatrix} 2 \\ 1 \end{pmatrix} = \begin{pmatrix} 3e^{-3t} - 2e^{-4t} & 3e^{-3t} - e^{-4t} \end{pmatrix} \begin{pmatrix} 1 \\ 2 \end{pmatrix} = 9e^{-3t} - 5e^{-4t}.$$

For the second term since the input is a unit step $u(\tau) = 1$ and all the elements in the second integral will be of the form $\int_0^t Ke^{m(t-\tau)}d\tau = (K/m)(e^{mt} - 1)$, where K and m are constants. Thus this term is

$$\begin{pmatrix} 1 & 2 \end{pmatrix} \begin{pmatrix} (1/3)(e^{-3t} - 1) - (1/2)(e^{-4t} - 1) & (1/3)(e^{-3t} - 1) - (1/4)(e^{-4t} - 1) \\ (-2/3)(e^{-3t} - 1) + (1/2)(e^{-4t} - 1) & (-2/3)(e^{-3t} - 1) + (1/4)(e^{-4t} - 1) \end{pmatrix} \begin{pmatrix} 1 \\ 2 \end{pmatrix} =$$

$$\begin{pmatrix} -(e^{-3t} - 1) + (1/2)(e^{-4t} - 1) & -(e^{-3t} - 1) + (1/4)(e^{-4t} - 1) \end{pmatrix} \begin{pmatrix} 1 \\ 2 \end{pmatrix} = 2 - 3e^{-3t} + e^{-4t}$$

Thus as before the total output $y(t) = 2 + 6e^{-3t} - 4e^{-4t}$.

$$(b) (i) \text{ In this case } C(sI - A)^{-1}x(0) = \begin{pmatrix} 1 & 2 \end{pmatrix} \begin{pmatrix} \frac{s}{(s+1)(s+4)} & \frac{4}{(s+1)(s+4)} \\ \frac{-1}{(s+1)(s+4)} & \frac{s+5}{(s+1)(s+4)} \end{pmatrix} \begin{pmatrix} 1 \\ 2 \end{pmatrix} = \frac{5s+26}{(s+1)(s+4)}, \text{ which}$$

on inversion gives $7e^{-t} - 2e^{-4t}$. The unit step response is the inverse Laplace transform of $\frac{3}{s(s+1)}$

which is $3 - 3e^{-t}$ and contains no term in e^{-4t} as this mode is uncontrollable. The total response is $3 - 4e^{-t} - 2e^{-4t}$.

(ii) The initial condition response is

$$Ce^{At}x(0) = \begin{pmatrix} 1/3 & 2/3 \end{pmatrix} \begin{pmatrix} -e^{-t} + 4e^{-4t} & 4e^{-t} - 4e^{-4t} \\ -e^{-t} + e^{-4t} & 4e^{-t} - e^{-4t} \end{pmatrix} \begin{pmatrix} 1 \\ 2 \end{pmatrix} = 7e^{-t} - 2e^{-4t} \text{ as before and the step response is } \begin{pmatrix} 1/3 & 2/3 \end{pmatrix} \begin{pmatrix} e^{-t} - 1 - (e^{-4t} - 1) & -4(e^{-t} - 1) + e^{-4t} - 1 \\ e^{-t} - 1 - (1/4)(e^{-4t} - 1) & -4(e^{-t} - 1) + (1/4)(e^{-4t} - 1) \end{pmatrix} \begin{pmatrix} 1 \\ 1 \end{pmatrix} = 3 - 3e^{-t} \text{ as expected.}$$

(c) (i) For this case

$$C(sI - A)^{-1}x(0) = \begin{pmatrix} 4 & -1 & 2 \end{pmatrix} \begin{pmatrix} \frac{s-1}{(s+1)(s+3)} & \frac{1}{(s+2)(s+3)} & \frac{-1}{(s+1)(s+2)} \\ -4 & s+4 & -2 \\ \frac{4}{(s+1)(s+3)} & \frac{-1}{(s+2)(s+3)} & \frac{s+3}{(s+1)(s+2)} \end{pmatrix} \begin{pmatrix} 1 \\ -1 \\ 2 \end{pmatrix} =$$

$$\begin{pmatrix} \frac{4(s+2)}{(s+1)(s+3)} & \frac{-1}{s+3} & \frac{2}{s+1} \end{pmatrix} \begin{pmatrix} 1 \\ -1 \\ 2 \end{pmatrix} = \frac{9s+21}{(s+1)(s+3)} = \frac{6}{s+1} + \frac{3}{s+3}$$

This is a time domain response of $6e^{-t} + 3e^{-3t}$ with no term in e^{-2t} as this mode is unobservable. The step response in the s-domain is $\frac{3s+7}{s(s+1)(s+3)}$ which inverts to $(7/3) - 2e^{-t} - (1/3)e^{-3t}$ giving a total response of $(7/3) + 4e^{-t} + (8/3)e^{-3t}$.

In the time domain the initial condition response is

$$\begin{pmatrix} 4 & -1 & 2 \end{pmatrix} \begin{pmatrix} -e^{-t} + 2e^{-3t} & e^{-2t} - e^{-3t} & -e^{-t} + e^{-2t} \\ -2e^{-t} + 2e^{-3t} & 2e^{-2t} - e^{-3t} & -2e^{-t} + 2e^{-2t} \\ 2e^{-t} - 2e^{-3t} & -e^{-2t} + e^{-3t} & 2e^{-t} - e^{-2t} \end{pmatrix} \begin{pmatrix} 1 \\ -1 \\ 2 \end{pmatrix} =$$

$$\begin{pmatrix} 2e^{-t} + 2e^{-3t} & -e^{-3t} & 2e^{-t} \end{pmatrix} \begin{pmatrix} 1 \\ -1 \\ 2 \end{pmatrix} = 6e^{-t} + 3e^{-3t}$$

The step response is

$$(4 \quad -1 \quad 2)^* \begin{pmatrix} e^{-t} - 1 - (2/3)(e^{-3t} - 1) & -(1/2)(e^{-2t} - 1) + (1/3)(e^{-3t} - 1) & e^{-t} - 1 - (1/2)(e^{-2t} - 1) \\ 2(e^{-t} - 1) - (2/3)(e^{-3t} - 1) & -(e^{-2t} - 1) + (1/3)(e^{-3t} - 1) & 2(e^{-t} - 1) - (e^{-2t} - 1) \\ -2(e^{-t} - 1) + (2/3)(e^{-3t} - 1) & (1/2)(e^{-2t} - 1) - (1/3)(e^{-3t} - 1) & -2(e^{-t} - 1) + (1/2)(e^{-2t} - 1) \end{pmatrix} \begin{pmatrix} 2 \\ 3 \\ -1 \end{pmatrix}$$

which gives

$$\begin{pmatrix} 2 - 2e^{-t} - (2/3)(e^{-3t} - 1) & (1/3)(e^{-3t} - 1) & -2(e^{-t} - 1) \\ 3 & 3 & 3 \\ -1 & -1 & -1 \end{pmatrix} = (7/3) - 2e^{-t} - (1/3)e^{-3t} \text{ as before}$$

and giving a total response of $(7/3) + 4e^{-t} + (8/3)e^{-3t}$.

Example 6.8

Obtain the controllable canonical form for the state space descriptions of example 6.4 from

- i) The transfer function
- ii) Use of the appropriate transformation matrix.



UPPSALA
UNIVERSITET

Develop the tools we need for Life Science Masters Degree in Bioinformatics

Bioinformatics is the exciting field where biology, computer science, and mathematics meet.

We solve problems from biology and medicine using methods and tools from computer science and mathematics.

Read more about this and our other international masters degree programmes at www.uu.se/master



Click on the ad to read more

(a)(i) The transfer function is $\frac{5s+24}{s^2+7s+12}$ so that in controllable canonical form $A_c = \begin{pmatrix} 0 & 1 \\ -12 & -7 \end{pmatrix}$, $B_c = \begin{pmatrix} 0 \\ 1 \end{pmatrix}$, $C_c = (24 \ 5)$ and $D_c = 0$.

(ii) The transformation matrix T to give the controllable canonical has column vectors t_n given by $t_n = B$, $At_1 = -a_0t_n$, $At_2 = t_1 - a_1t_n$, $At_3 = t_2 - a_2t_n$, etc. where the a 's are the coefficients of the characteristic equation. For a second order system this gives the three equations $t_2 = B$, $At_1 = -a_0t_2$, $At_2 = t_1 - a_1t_2$, only two of which need to be used. Using the first two gives $t_2 = \begin{pmatrix} 1 \\ 2 \end{pmatrix}$ and $t_1 = -a_0A^{-1}t_2 = -12 * \begin{pmatrix} -1/6 & 1/12 \\ -1/6 & -5/12 \end{pmatrix} \begin{pmatrix} 1 \\ 2 \end{pmatrix} = \begin{pmatrix} 0 \\ 12 \end{pmatrix}$, thus

$$T = \begin{pmatrix} 0 & 1 \\ 12 & 2 \end{pmatrix} \text{ and } A_c = T^{-1}AT = \begin{pmatrix} -1/6 & 1/12 \\ 1 & 0 \end{pmatrix} \begin{pmatrix} -5 & -1 \\ 2 & -2 \end{pmatrix} \begin{pmatrix} 0 & 1 \\ 12 & 2 \end{pmatrix} = \begin{pmatrix} 0 & 1 \\ -12 & -7 \end{pmatrix}$$

$$B_c = T^{-1}B = \begin{pmatrix} -1/6 & 1/12 \\ 1 & 0 \end{pmatrix} \begin{pmatrix} 1 \\ 2 \end{pmatrix} = \begin{pmatrix} 0 \\ 1 \end{pmatrix}, C_c = CT = (1 \ 2) \begin{pmatrix} 0 & 1 \\ 12 & 2 \end{pmatrix} = (24 \ 5) \text{ and } D_c = 0.$$

(b)(i) This second order system was found to be uncontrollable and its transfer function reduced to $\frac{3}{s+1}$.

(ii) Because the system is uncontrollable no transformation matrix T can be found. The calculations give $t_2 = \begin{pmatrix} 1 \\ 1 \end{pmatrix}$ and $t_1 = -4 \begin{pmatrix} 0 & -1 \\ 1/4 & -5/4 \end{pmatrix} \begin{pmatrix} 1 \\ 1 \end{pmatrix} = \begin{pmatrix} 4 \\ 4 \end{pmatrix}$, giving $T = \begin{pmatrix} 1 & 4 \\ 1 & 4 \end{pmatrix}$, which is singular as its determinant is zero and therefore no inverse exists.

(c)(i) This state space description was found to be controllable but not observable with a transfer function

of $\frac{3s^3+13s+14}{s^3+6s^2+11s+6} = \frac{3s+7}{s^2+4s+3}$ after cancelling the common factor of $s+2$. As a third order

system it has a controllable canonical form of $A_c = \begin{pmatrix} 0 & 1 & 0 \\ 0 & 0 & 1 \\ -6 & -1 & -6 \end{pmatrix}$, $B_c = \begin{pmatrix} 0 \\ 0 \\ 1 \end{pmatrix}$ and $C_c = CT = (14 \ 13 \ 3)$. As a minimum realisation its controllable canonical form is

$$A_c = \begin{pmatrix} 0 & 1 \\ -3 & -4 \end{pmatrix}, B_c = \begin{pmatrix} 0 \\ 1 \end{pmatrix} \text{ and } C_c = (7 \ 3).$$

(ii) The column vectors for the transformation matrix T are given by $t_3 = B$, $t_1 = -a_0 A^{-1} t_3$ and

$$t_2 = A^{-1} t_1 - a_1 A^{-1} t_3. \text{ For this system } A = \begin{pmatrix} -5 & 1 & -1 \\ -4 & -1 & -2 \\ 4 & -1 & 0 \end{pmatrix} \text{ giving}$$

$$A^{-1} = \begin{pmatrix} 1/3 & -1/6 & 1/2 \\ 4/3 & -2/3 & 1 \\ -4/3 & 1/6 & -3/2 \end{pmatrix} \text{ so that } t_3 = \begin{pmatrix} 2 \\ 3 \\ -1 \end{pmatrix}, t_1 = -\begin{pmatrix} -2 & 1 & -3 \\ -8 & 4 & -6 \\ 8 & -1 & 9 \end{pmatrix} \begin{pmatrix} 2 \\ 3 \\ -1 \end{pmatrix} = \begin{pmatrix} 2 \\ 2 \\ 4 \end{pmatrix} \text{ and}$$

$$t_2 = \begin{pmatrix} 1/3 & -1/6 & 1/2 \\ 4/3 & -2/3 & 1 \\ -4/3 & 1/6 & -3/2 \end{pmatrix} \begin{pmatrix} -20 \\ -31 \\ 15 \end{pmatrix} = \begin{pmatrix} 6 \\ 9 \\ -1 \end{pmatrix} \text{ giving } T = \begin{pmatrix} 2 & 6 & 2 \\ 2 & 9 & 3 \\ 4 & -1 & -1 \end{pmatrix} \text{ with}$$

$$T^{-1} = \begin{pmatrix} 3/2 & -1 & 0 \\ -7/2 & 5/2 & 1/2 \\ 19/2 & -13/2 & -3/2 \end{pmatrix}. \text{ On substituting the appropriate matrices this gives}$$

$$A_c = T^{-1} A T = \begin{pmatrix} 0 & 1 & 0 \\ 0 & 0 & 1 \\ -6 & -11 & -6 \end{pmatrix}, B_c = T^{-1} B = \begin{pmatrix} 0 \\ 0 \\ 1 \end{pmatrix} \text{ and } C_c = C T = (14 \quad 13 \quad 3) \text{ as expected.}$$

$$(d)(i) \text{ For this system } A = \begin{pmatrix} -15 & -16 & -8 \\ 15 & 17 & 10 \\ -16 & -17 & -8 \end{pmatrix}, \text{ giving } A^{-1} = (1/6) \begin{pmatrix} +34 & -8 & 24 \\ 40 & 8 & -30 \\ -17 & -1 & 15 \end{pmatrix}. \text{ For the}$$

$$\text{transformation matrix } t_3 = \begin{pmatrix} 1 \\ -1 \\ 1 \end{pmatrix}, t_1 = -6A^{-1}t_3 = \begin{pmatrix} 2 \\ -2 \\ 1 \end{pmatrix} \text{ and } t_2 = A^{-1}(t_1 - 11t_3) = A^{-1} \begin{pmatrix} -9 \\ 9 \\ -10 \end{pmatrix} = \begin{pmatrix} -1 \\ 2 \\ -1 \end{pmatrix}$$

$$\text{giving } T = \begin{pmatrix} 2 & -1 & 1 \\ -2 & 2 & -1 \\ 1 & -1 & 1 \end{pmatrix} \text{ and } T^{-1} = \begin{pmatrix} 1 & 0 & -1 \\ 1 & 1 & 0 \\ 0 & 1 & 2 \end{pmatrix}. \text{ As expected on substituting the appropriate}$$

$$\text{matrices } A_c = T^{-1} A T = \begin{pmatrix} 0 & 1 & 0 \\ 0 & 0 & 1 \\ -6 & -11 & -6 \end{pmatrix}, B_c = T^{-1} B = \begin{pmatrix} 0 \\ 0 \\ 1 \end{pmatrix} \text{ and } C_c = C T = (3 \quad -2 \quad 2).$$

Example 6.9

State space descriptions (a), (c) and (d) of example 6.4 are all controllable. Determine the required state feedback gains to move the poles in (a) to -5 and -6 and in (c) and (d) to -4, -5 and -6. Determine also the resulting system transfer functions from the new input r to the output y .

(a) This system has $A = \begin{pmatrix} -5 & -1 \\ 2 & -2 \end{pmatrix}$, $B = \begin{pmatrix} 1 \\ 2 \end{pmatrix}$, $C = (1 \ 2)$ and $D = 0$, with controllable canonical

form $A_c = \begin{pmatrix} 0 & 1 \\ -12 & -7 \end{pmatrix}$, $B_c = \begin{pmatrix} 0 \\ 1 \end{pmatrix}$ and $C_c = (24 \ 5)$. With $D = 0$ and state feedback such that

$u = r - k^T x$, the new system A matrix A_f is given by $A_f = A - Bk^T$. Using the controllable

canonical form this gives $A_{fc} = A_c - B_c k_c^T = \begin{pmatrix} 0 & 1 \\ -12 - k_{1c} & -7 - k_{2c} \end{pmatrix}$. For the characteristic equation

to be $s^2 + 11s + 30 = 0$, this requires the components of k_c^T to be $k_{1c} = 18$ and $k_{2c} = 4$, where

the subscript c relates to the canonical form. The transfer function is

$C_c(sI - A_{fc})^{-1}B_c = \frac{5s + 24}{s^2 + 11s + 30}$. Using the transformation matrix T between the original

system and its canonical form the required feedback in terms of the original system states is

$k_c^T x_c = k_c^T T^{-1}x = (18 \ 4) \begin{pmatrix} -1/6 & 1/12 \\ 1 & 0 \end{pmatrix} x = (1 \ 3/2)x$. The required feedback is thus $k^T = (1 \ 3/2)$.

If this feedback is calculated directly from the system representation then

$A_f = A - Bk^T = \begin{pmatrix} -5 - k_1 & -1 - k_2 \\ 2 - 2k_1 & -2 - 2k_2 \end{pmatrix}$, which has the characteristic equation

$s^2 + s(7 + k_1 + 2k_2) + 12 + 12k_2$, where by chance the constant term is independent of k_1 . For

this characteristic equation to be $s^2 + 11s + 30 = 0$, requires $k_1 = 1$ and $k_2 = 3/2$ as expected.

Thus if one does not transform to the controllable canonical form one typically has a set of

simultaneous equations to solve for the gain values. The transfer function is

$C(sI - A_f)^{-1}B = (1 \ 2) \begin{pmatrix} s+6 & 5/2 \\ 0 & s+5 \end{pmatrix}^{-1} \begin{pmatrix} 1 \\ 2 \end{pmatrix} = \frac{(1 \ 2)}{s^2 + 11s + 30} \begin{pmatrix} s+5 & -5/2 \\ 0 & s+6 \end{pmatrix} \begin{pmatrix} 1 \\ 2 \end{pmatrix} = \frac{5s + 24}{s^2 + 11s + 30}$ as expected.

(c) This system has $A = \begin{pmatrix} -5 & 1 & -1 \\ -4 & -1 & -2 \\ 4 & -1 & 0 \end{pmatrix}$, $B = \begin{pmatrix} 2 \\ 3 \\ -1 \end{pmatrix}$, $C = (4 \quad -1 \quad 2)$, $D = 0$, with transformation matrix to controllable canonical form of $T = \begin{pmatrix} 2 & 6 & 2 \\ 2 & 9 & 3 \\ 4 & -1 & -1 \\ 0 & 1 & 0 \\ 0 & 0 & 1 \\ -6 - k_{1c} & -11 - k_{2c} & -6 - k_{3c} \end{pmatrix}$ and $T^{-1} = \begin{pmatrix} 3/2 & -1 & 0 \\ -7/2 & 5/2 & 1/2 \\ 19/2 & -13/2 & -3/2 \end{pmatrix}$. Using the controllable canonical form $A_{fc} = \begin{pmatrix} 0 & 1 & 0 \\ 0 & 0 & 1 \\ -6 - k_{1c} & -11 - k_{2c} & -6 - k_{3c} \end{pmatrix}$, and the characteristic equation $s^3 + s^2(6 + k_{3c}) + s(1 + k_{2c}) + 6 + k_{1c} = 0$ is required to be $s^3 + 15s^2 + 74s + 120 = 0$.

This gives $k_c^T = (114 \quad 63 \quad 9)$ and the feedback required from the original states is

$$k^T = k_c^T T^{-1} = (114 \quad 63 \quad 9) \begin{pmatrix} 3/2 & -1 & 0 \\ -7/2 & 5/2 & 1/2 \\ 19/2 & -13/2 & -3/2 \end{pmatrix} = (36 \quad -15 \quad 18). \text{ The transfer function is}$$

$C_c (sI - A_{fc})^{-1} B_c$ which gives $\frac{3s^2 + 13s + 14}{(s+4)(s+5)(s+6)}$. Note that there is now no numerator root term

which cancels a denominator one so the transfer function is third order and the system is observable.

If one does not use the transformation approach then $(sI - A_f) = \begin{pmatrix} s+5+2k_1 & -1+2k_2 & 1+2k_3 \\ 4+3k_1 & s+1+3k_2 & 2+3k_3 \\ -4-k_1 & 1-k_2 & s-k_3 \end{pmatrix}$

and working out the values of the three k 's to obtain $k^T = (36 \quad -15 \quad 18)$ for $\det(sI - A_f)$ to equal

$s^3 + 15s^2 + 74s + 120$ is extremely laborious.

(d) Since this system has the same A_c and B_c as the previous example k_c^T is again given by $k_c^T = (114 \quad 63 \quad 9)$ and the transfer function with the state feedback is $\frac{2s^2 - 2s + 3}{(s+4)(s+5)(s+6)}$. The required feedback from the original states is

$$k^T = k_c^T T^{-1} = (114 \quad 63 \quad 9) \begin{pmatrix} 1 & 0 & -1 \\ 1 & 1 & 0 \\ 0 & 1 & 2 \end{pmatrix} = (177 \quad 72 \quad -210).$$

It should be noted that provided the system is controllable and observable the zeros of the transfer function are not changed by state variable feedback. Also since in the last two examples the pole values have been moved appreciably relatively high feedback gains are required, which could cause saturation problems in a practical implementation.

6.3 Problems

Problem 6.1

Figure P6.1 shows an R-C network. Assuming the resistors to be each equal to R and the capacitors each equal to C obtain a state space representation in terms of $T = RC$ for the circuit for the following two choices of state variables. (i) the output voltage and its derivative and (ii) the voltages across the two capacitors. Confirm the A matrices for the two representations have the same trace, determinant and eigenvalues.

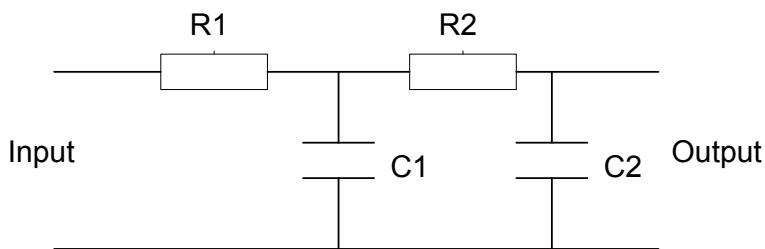

Figure P6.1 Simple R-C circuit.

$$[A = \begin{pmatrix} 0 & 1 \\ -1/T^2 & -3/T \end{pmatrix}, B = \begin{pmatrix} 0 \\ 1 \end{pmatrix}, C = (1/T^2 \quad 0), D = 0.]$$

$$A = \begin{pmatrix} -1/T & 1/T \\ 1/T & -2/T \end{pmatrix} B = \begin{pmatrix} 0 \\ 1/T \end{pmatrix} C = (1 \quad 0) D = 0]$$

Problem 6.2

Figure P6.2 shows an RLC circuit. Derive the transfer function from the input voltage V_i to the output voltage V_o . Obtain the A, B, C, D matrices for state space models using (i) the output voltage and its derivative as the state variables and (ii) the output voltage and the current through the inductance as state variables. Check that the A matrices have the same trace, determinant and eigenvalues for the two representations.

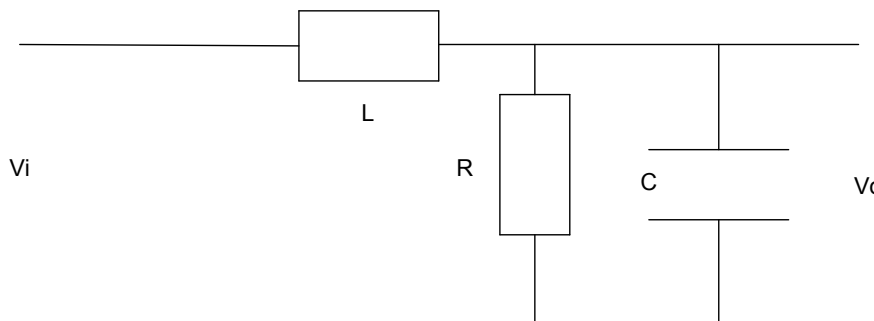

Figure P6.2 RLC circuit

$$[A = \begin{pmatrix} 0 & 1 \\ -1/LC & -1/RC \end{pmatrix}, B = \begin{pmatrix} 0 \\ 1 \end{pmatrix}, C = (1/LC \ 0), D = 0.]$$

$$A = \begin{pmatrix} -1/RC & 1/C \\ -1/L & 0 \end{pmatrix} B = \begin{pmatrix} 0 \\ 1/L \end{pmatrix} C = (1 \ 0) D = 0]$$

Problem 6.3

Give state space descriptions in (a) controllable canonical form and (b) diagonal form for the following transfer functions:-

$$\text{i) } G(s) = \frac{1}{s^2 + 3s + 2}$$

$$\text{ii) } G(s) = \frac{s + 2}{s^3 + 4s^2 + 4s + 3}$$

$$\text{iii) } G(s) = \frac{10(s + 1)(s + 2)}{s^3 + 7s^2 + 12s}$$

$$\text{iv) } G(s) = \frac{2s + 1}{s^3 + 6s^2 + 11s + 6}$$

UNIVERSITY OF COPENHAGEN



Copenhagen Master of Excellence

Copenhagen Master of Excellence are two-year master degrees taught in English at one of Europe's leading universities

Come to Copenhagen - *and aspire!*

Apply now at
www.come.ku.dk

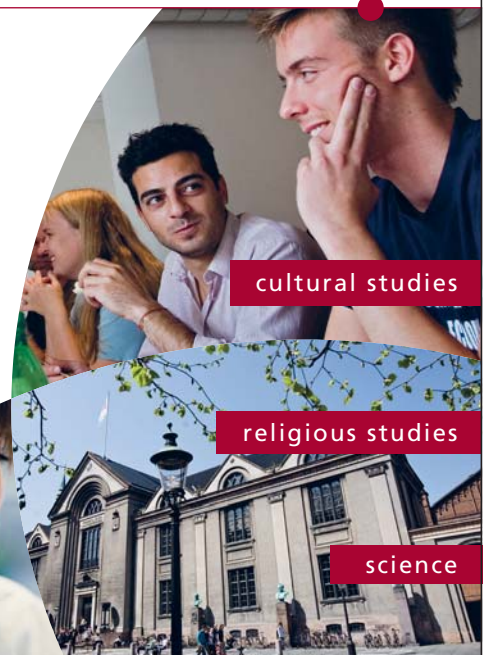

$$\text{v) } G(s) = \frac{2s+1}{s^3+7s^2+14s+8}$$

$$\text{vi) } G(s) = \frac{2s^2+12s+15}{s^2+5s+6}$$

$$[(\text{i}) A = \begin{pmatrix} 0 & 1 \\ -2 & -3 \end{pmatrix}, B = \begin{pmatrix} 0 \\ 1 \end{pmatrix}, C = (1 \ 0), D = 0; A = \begin{pmatrix} -1 & 0 \\ 0 & -2 \end{pmatrix}, B = \begin{pmatrix} 1 \\ 1 \end{pmatrix}, C = (1 \ -1),$$

$$D = 0. (\text{ii}) A = \begin{pmatrix} 0 & 1 & 0 \\ 0 & 0 & 1 \\ -3 & -4 & -4 \end{pmatrix}, B = \begin{pmatrix} 0 \\ 0 \\ 1 \end{pmatrix}, C = (2 \ 1 \ 0), D = 0 ;$$

$$A = \begin{pmatrix} -3 & 0 & 0 \\ 0 & -0.5 & 0.866 \\ 0 & -0.866 & -0.5 \end{pmatrix}, B = \begin{pmatrix} 1 \\ 1 \\ 1 \end{pmatrix}, C = (-0.1429 \ 0.4426 \ -0.2997), D = 0. (\text{iii})$$

$$A = \begin{pmatrix} 0 & 1 & 0 \\ 0 & 0 & 1 \\ 0 & -12 & -7 \end{pmatrix}, B = \begin{pmatrix} 0 \\ 0 \\ 1 \end{pmatrix}, C = (20 \ 30 \ 10), D = 0; A = \begin{pmatrix} 0 & 0 & 0 \\ 0 & -3 & 0 \\ 0 & 0 & -4 \end{pmatrix}, B = \begin{pmatrix} 1 \\ 1 \\ 1 \end{pmatrix},$$

$$C = (1.667 \ 6.667 \ 15), D = 0. (\text{iv}) A = \begin{pmatrix} 0 & 1 & 0 \\ 0 & 0 & 1 \\ -6 & -11 & -6 \end{pmatrix}, B = \begin{pmatrix} 0 \\ 0 \\ 1 \end{pmatrix}, C = (1 \ 2 \ 0),$$

$$D = 0; A = \begin{pmatrix} -1 & 0 & 0 \\ 0 & -2 & 0 \\ 0 & 0 & -3 \end{pmatrix}, B = \begin{pmatrix} 1 \\ 1 \\ 1 \end{pmatrix}, C = (-0.5 \ 3 \ -2.5), D = 0. (\text{v})$$

$$A = \begin{pmatrix} 0 & 1 & 0 \\ 0 & 0 & 1 \\ -8 & -14 & -7 \end{pmatrix}, B = \begin{pmatrix} 0 \\ 0 \\ 1 \end{pmatrix}, C = (1 \ 2 \ 0), D = 0; A = \begin{pmatrix} -1 & 0 & 0 \\ 0 & -2 & 0 \\ 0 & 0 & -4 \end{pmatrix}, B = \begin{pmatrix} 1 \\ 1 \\ 1 \end{pmatrix},$$

$$C = (-1/3 \ 3/2 \ -7/6), D = 0. (\text{vi}) A = \begin{pmatrix} 0 & 1 \\ -6 & -5 \end{pmatrix}, B = \begin{pmatrix} 0 \\ 1 \end{pmatrix}, C = (3 \ 2), D = 2;$$

$$A = \begin{pmatrix} -2 & 0 \\ 0 & -3 \end{pmatrix}, B = \begin{pmatrix} 1 \\ 1 \end{pmatrix}, C = (-1 \ 3), D = 2.]$$

Problem 6.4

Obtain a state representation of the differential equation $\ddot{x} + 3\dot{x} + 3x = \dot{u} + u$ with the output $y = x$

$$[A = \begin{pmatrix} -3 & 1 & 0 \\ -3 & 0 & 1 \\ -1 & 0 & 0 \end{pmatrix}, B = \begin{pmatrix} 0 \\ 1 \\ 1 \end{pmatrix}, C = (1 \ 0 \ 0), D = 0.]$$

Problem 6.5

A system has a state space representation with matrices:-

$$A = \begin{pmatrix} -6 & -3 \\ 4 & 1 \end{pmatrix}, B = \begin{pmatrix} 1 \\ 1 \end{pmatrix}, C = (2 \quad 1) \text{ and } D = 0. \text{ Find}$$

- The eigenvalues of the A matrix.
- Its state transition matrix.
- Its transfer function.
- The output response to an initial value of the state vector equal to $(1 \quad 1)^T$ and a unit step input.
- The phase of the output relative to the input in the steady state if the input is a sinusoid of frequency 1 rad/s.
- If $B = (1 \quad b)^T$ not $(1 \quad 1)^T$, find any values of b for which the system is uncontrollable.

$$[-2, -3; \begin{pmatrix} -3e^{-2t} + 4e^{-3t} & -3e^{-2t} + 3e^{-3t} \\ 4e^{-2t} - 4e^{-3t} & 4e^{-2t} - 3e^{-3t} \end{pmatrix}; \frac{3s+2}{(s+2)(s+3)}; (1/3) - 2e^{-2t} + (14/3)e^{-3t}; 11.3^\circ; -1 \text{ and } -4/3.]$$

Problem 6.6

Find the transformation matrix T to transform the A matrix in problem 6.5 to the diagonal form and use this to obtain the state transition matrix.

$$[T = \begin{pmatrix} 3 & 1 \\ -4 & -1 \end{pmatrix}.]$$

Problem 6.7

Find the state transition matrix for problem 6.5 using the Cayley Hamilton theorem.

Problem 6.8

A system has a state space representation with:-

$$A = \begin{pmatrix} 1 & -2 \\ 4 & -5 \end{pmatrix}, B = \begin{pmatrix} 0 \\ 1 \end{pmatrix}, C = (1 \quad c) \text{ and } D = 0. \text{ Find}$$

- Its state transition matrix.
- Its transfer function.
- The output response with no input for $c = 1$ and an initial state vector $(2 \quad 1)^T$.
- Any values of c for which the system is unobservable.

$$[\begin{pmatrix} 2e^{-t} - e^{-3t} & -e^{-t} + e^{-3t} \\ 2e^{-t} - 2e^{-3t} & -e^{-t} + 2e^{-3t} \end{pmatrix}, \frac{cs - 2 - c}{(s+1)(s+3)}, 6e^{-t} - 3e^{-3t}, -1/2 \text{ and } -1.]$$

Problem 6.9

It has been noted in Example 6.9 that the zeros of the transfer function are not changed by state variable feedback. This is a consequence of the fact that

$$(sI - A_c)^{-1} B_c = \frac{1}{\det(sI - A_c)} \begin{pmatrix} 1 \\ s \\ s^2 \\ \cdot \\ \cdot \\ s^{n-1} \end{pmatrix}, \text{ where } A_c \text{ and } B_c \text{ are in the controllable canonical form. Prove}$$

this result.

Problem 6.10

Find the transformation matrix to transform the state space description $A = \begin{pmatrix} -7 & 3 \\ -6 & 2 \end{pmatrix}$, $B = \begin{pmatrix} 2 \\ 1 \end{pmatrix}$, $C = (1 \ 0)$, $D = 0$ to the controllable canonical form and find this form. Determine the state feedback gains to place both poles at -2 and the resulting input-output transfer function.

$$[T = \begin{pmatrix} -1 & 2 \\ -5 & 1 \end{pmatrix}, A_c = \begin{pmatrix} 0 & 1 \\ -4 & -5 \end{pmatrix}, B_c = \begin{pmatrix} 0 \\ 1 \end{pmatrix}, C_c = (-1 \ 2) \text{ and } D_c = 0. k^T = (-5/9 \ 1/9) \text{ and } \frac{(2s-1)}{(s+2)^2}.]$$

Problem 6.11

A system has $A = \begin{pmatrix} 0 & 1 \\ 6 & 1 \end{pmatrix}$, $B = \begin{pmatrix} 1 \\ 1 \end{pmatrix}$, show that it is unstable but controllable and find its controllable canonical form. Find also the feedback gains required to move the unstable pole to -5 and keep the stable pole unchanged.

$$[A_c = \begin{pmatrix} 0 & 1 \\ 6 & 1 \end{pmatrix}, B_c = \begin{pmatrix} 0 \\ 1 \end{pmatrix}, \text{ and } k^T = (16/3 \ 8/3).]$$

Problem 6.12

Find the transformation matrix to transform the state space description $A = \begin{pmatrix} 2 & 1 \\ -12 & -5 \end{pmatrix}$, $B = \begin{pmatrix} 0 \\ 1 \end{pmatrix}$, $C = (1 \ 2)$, $D = 0$ to the controllable canonical form and find this form. Determine the state feedback gains to place the poles at -3 and -4. Do this both by (i) using the transformation matrix for the controllable canonical form and (ii) transforming to diagonal form and using the feedback gains required for the diagonal form. What is the new input-output transfer function?

$$\left[T = \begin{pmatrix} 1 & 0 \\ -2 & 1 \end{pmatrix}, A_c = \begin{pmatrix} 0 & 1 \\ -2 & -3 \end{pmatrix}, B_c = \begin{pmatrix} 0 \\ 1 \end{pmatrix}, C_c = (-3 \ 2), k^T = (18 \ 4), \frac{2s+1}{s^2+7s+12} \right]$$

Problem 6.13

For the controllable canonical form of the transfer function (v) of Problem 6.3 find the required feedback gains to place all the poles at $s = -1$. What is the new input-output transfer function?

$$\left[k^T = (7 \ 11 \ 4), \frac{2s+1}{(s+1)^3} \right].$$

Problem 6.14

A system has the controllable canonical form state space representation

$$A = \begin{pmatrix} 0 & 1 & 0 \\ 0 & 0 & 1 \\ -12 & -19 & -8 \end{pmatrix}, B = \begin{pmatrix} 0 \\ 0 \\ 1 \end{pmatrix}, C = (2 \ 1 \ 0), D = 0; \text{ Find:-}$$

- i) The eigenvalues of the A matrix.
- ii) The required state feedback gains to move all the poles to -1.
- iii) The transformation matrix T to put the system in diagonal form.
- iv) The required state feedback gains to place all the poles at -1 for the diagonal form.

$$[-1, -3, -4; k = (-11, -16, -5); T = \begin{pmatrix} 1 & 1 & 1 \\ -1 & -3 & -4 \\ 1 & 9 & 16 \end{pmatrix}; k = (0, -8, -27)]$$

Problem 6.15

A system is described by the following A, B, C, D matrices:-

$$A = \begin{pmatrix} 42 & -11 & 37 \\ 44 & -13 & 36 \\ -40 & 10 & -36 \end{pmatrix}, B = \begin{pmatrix} -1 \\ -1 \\ 1 \end{pmatrix}, C = (5 \quad -2 \quad 3), D = 0; \text{ Find:-}$$

- 1) The eigenvalues of the A matrix
- 2) The transformation matrix T to put the system into the controllable canonical form
- 3) The required state feedback gains to place all the poles at -1 .

$$[-1, -2, -4; T = \begin{pmatrix} 3 & -1 & -1 \\ 4 & -2 & -1 \\ -2 & 1 & 1 \end{pmatrix}; k = (29, -7, -26)]$$

7 Control System Design

7.1 Introduction

This chapter is concerned with the design of linear feedback control systems to meet specified design criteria. It covers problems relating to the material of chapters 7, 8, 9 and 11 of reference1. Extensive use is made of Matlab to get open loop frequency response and closed loop step response data. Many numerical answers given have been taken from Matlab plots using the cursor so should not be regarded as exact but are sufficiently accurate to compare the results of different design approaches. More time could have been taken to get more accurate numbers, for example by doing plots with more points or over shorter ranges but this really serves no purpose as in many practical problems models are approximate and their parameters are in many cases not known to better than 10%.



Brain power

By 2020, wind could provide one-tenth of our planet's electricity needs. Already today, SKF's innovative know-how is crucial to running a large proportion of the world's wind turbines.

Up to 25 % of the generating costs relate to maintenance. These can be reduced dramatically thanks to our systems for on-line condition monitoring and automatic lubrication. We help make it more economical to create cleaner, cheaper energy out of thin air.

By sharing our experience, expertise, and creativity, industries can boost performance beyond expectations. Therefore we need the best employees who can meet this challenge!

The Power of Knowledge Engineering

Plug into The Power of Knowledge Engineering.
Visit us at www.skf.com/knowledge

SKF

The initial examples and problems concentrate on the design of classical controllers, namely phase lead, phase lag and PID controllers, Their use in both the error channel and feedback paths are considered. The advantages of these controllers, which are in series with the plant, are:- (i) their design is not difficult and since they have few parameters the effect of changing any one of them is easily understood (ii) the input signals they use, either the system output and/or the error, are readily available (iii) in many cases they can achieve the desired system performance requirements. Probably their major disadvantage is that they may not be able to maintain satisfactory performance if the plant parameters vary significantly, as shown in some examples. It may be possible to overcome this difficulty by the use of state feedback to change the system poles but this normally requires the measurement or estimation of additional signals. Also a state space model is required which may require more modelling effort than finding a transfer function or frequency response from plant input-output data. Some of these aspects are considered in the later examples.

7.2 Examples

Example 7.1

A control system has a plant transfer function of $G(s) = 2/s(1 + 0.4s)^2$. Show that in a feedback loop with a unit negative feedback gain it has a phase margin of 28.7° at the frequency 1.48 rads/s. Design both phase lead and lag compensators with unit gain at zero frequency so that the phase margin is increased to around 45° . Obtain the step responses using Matlab of the closed loop with a unit gain compensator and the phase lead and lag designs having the error signal as input. Design also a phase lead compensator using pole-zero cancellation to produce the same phase margin. Compare the overshoot, peak time, settling time and phase margin for all four designs in a Table.

$G(j\omega) = \frac{2}{j\omega(1 + 0.4j\omega)^2}$, so that $|G(j\omega)| = \frac{2}{\omega(1 + 0.16\omega^2)}$ giving $0.16\omega^3 + \omega = 2$ which has the solution $\omega = 1.48$. The corresponding phase is $-90 - 2 \tan^{-1} 0.4 * 1.48$ which equals -151.25° , giving a phase margin of 28.7° .

Thus to achieve a phase margin of around 45° the lead compensator using the classical design approach will require a maximum phase lead of $16.3+\epsilon^\circ$. For this transfer function, since both break points occur at the same frequency, the phase change will be quite rapid beyond the double break point so a relatively high value of ϵ should be taken. Thus considering Table 7.1 in reference 1 a value of $\alpha = 1/3$ will be tried. The peak gain for this value of α is 4.77dB. $G(j\omega)$ is approximately 4.77dB down at $\omega = 2.05$, so choosing this as the centre frequency of the lead network $G_c(s) = \frac{1+sT}{1+\alpha sT}$ gives $T\sqrt{\alpha} = 1/2.05$, so that $T \approx 0.84$. Using $G_c(s) = \frac{1+0.84s}{1+0.28s}$ gives a phase margin of 41° . Because of the rapid phase change of $G(j\omega)$ repeating the design for $\alpha = 1/4$ gives a smaller phase margin of around 37° . For the phase lag design the compensator $G_c(s) = \frac{1+sT}{1+\alpha sT}$ will now have $\alpha > 1$. and typically the breakpoint $1/T$ is chosen one decade below the required unity gain point of the open loop transfer function. Assuming the lag network has a phase lag of around 5° at the required unity gain point this means finding the frequency where $G(j\omega)$ has a lag of about 130° . This is $\omega \approx 0.91$, so that $T = 10/0.91$, giving approximately 11. The gain of $G(j\omega)$ at $\omega \approx 0.91$ is 1.95 so taking $\alpha = 2$ gives $G_c(s) = \frac{1+11s}{1+22s}$. The closed loop step responses for the lead and lag designs and a unit gain compensator are shown in Figure 7.1.

If the compensator is designed by pole-zero cancellation then $G_c(s)$ will be of the form $G_c(s) = \frac{1+0.4s}{1+sT}$. Choosing the time constant ratio to be of the same order as the lead design, i.e. 4, gives $G_c(s) = \frac{1+0.4s}{1+0.1s}$, which results in a phase margin of 47.3° and a step response with an overshoot of 13%. A comparison of the results is given in Table 7.1 with that labelled lead being for the classical design.

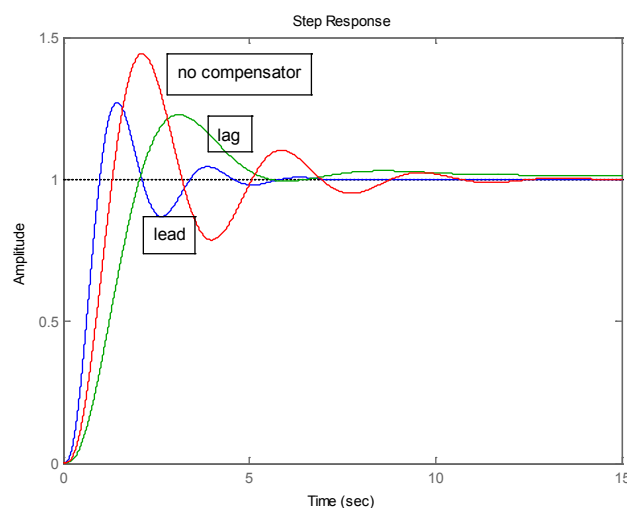

Figure 7.1 Comparison of closed loop step responses.

Compensator	%overshoot	Peak time,s.	Settling time,s.	Phase margin °
None	44	2.1	12.5	29 at 1.48rad/s
Classical phase lead	27	1.4	4.4	41 at 2.06rad/s
Cancellation phase lead	21	1.7	4.0	47 at 1.65rad/s
Phase lag	23	3.2	15	48 at 0.89rad/s

Table 7.1 Summary of step responses

Example 7.2

A control system has a plant transfer function of $G(s) = 2/s(1+0.5s)(1+0.1s)$. Calculate the phase margin. Design phase lead compensators by the classical approach and also by pole-zero cancellation with the same time constant ratio which yields a phase margin of 55° at $\omega = 1.80$. Design also a phase lag compensator to give the same phase margin. Estimate the difference in gain of the closed loop frequency response at high frequencies and confirm this by obtaining the closed loop frequency response plots. What is the significance of this with respect to any high frequency noise generated in the output position measurement device?

For the given transfer function $|G(j\omega)| = 2/\omega(1+0.25\omega^2)^{1/2}(1+0.01\omega^2)^{1/2}$ and this is equal to unity when $\omega = 1.56$. The corresponding phase of $G(j\omega)$ is then $-90 - \tan^{-1} 0.78 - \tan^{-1} 0.156 = -136.62$ giving a phase margin of 43.4° . The required additional phase lead to produce a phase margin of 55° is $12 + \varepsilon$, so a value of $\alpha = 1/2$ may be selected. $G(j\omega)$ is 3dB down when $\omega = 1.97$ so that $T = \sqrt{2}/1.97 \approx 0.72$ giving the compensator transfer function $G_c(s) = \frac{1+0.72s}{1+0.36s}$ which gives a phase margin of 53.6° at $\omega = 1.98$. (Note if $\alpha = 1/3$ is chosen the design gives $G_c(s) = \frac{1+0.77s}{1+0.26s}$ which provides a phase margin of 58.8° at $\omega = 2.24$). A pole-zero cancellation design with a time constant ratio of 2 gives $G_c(s) = \frac{1+0.5s}{1+0.25s}$ which yields a phase margin of 55.6° at $\omega = 180$.

For a phase lag design allowing for the lag network to give 5° phase lag at the required unit gain frequency requires $\angle G(j\omega) = -120^\circ$ which is given for $\omega = 0.91$ and the corresponding $|G(j\omega)| = 6db$ which corresponds to a gain of 2.0. Thus $T = 10/0.91 \approx 11$ and the resulting lag compensator has a transfer function of $G_c(s) = \frac{1+11s}{1+22s}$. The characteristics of the step response for all three designs with the compensators having the error as input are given in Table 7.2.

Compensator	%overshoot	Peak time,s.	Settling time,s.	Phase margin °
Classical phase lead	14	1.38	3.0	53.6 at 1.98rad/s
Cancellation phase lead	12	1.50	2.3	55.6 at 1.80rad/s
Phase lag	12	3.06	11	57.5 at 0.91rad/s

Table 7.2 Summary of step response results

The transfer function from a sensor measuring the output to the output is $\frac{G_c G}{1 + G_c G}$ whether the compensator has the output or error as input. At high frequencies the open loop gain will become small so that this transfer function approximates the open loop gain transfer function $G_c G$. The high frequency gain of the compensator $G_c(s) = \frac{1 + sT}{1 + \alpha sT}$ is $1/\alpha$. For the lead compensators this is 2 and for the lag compensator it is 0.5. Thus the difference in the gain at high frequency between the lead and lag compensators is 12dB, so that the effect of measurement noise can be significantly less for the lag compensator. The closed loop frequency responses for the system with the lead and lag compensators are shown in Figure 7.2.

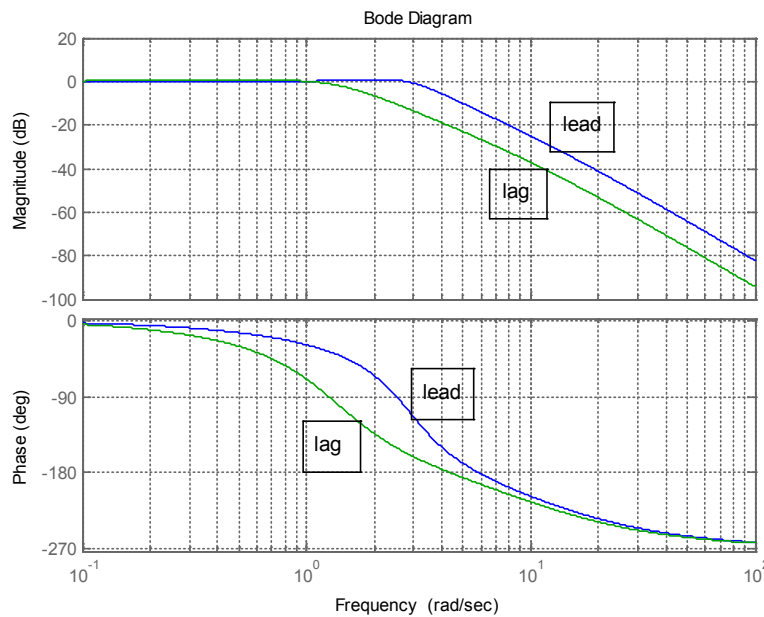

Figure 7.2 Closed loop frequency response plots.

Example 7.3

Two lead compensators were designed in each of Examples 7.1 and 7.2 and the results for step responses summarised in a Table. Add to the Tables the results if the compensators are placed in the feedback path having the output rather than error as input. What do you conclude from these results?

Compensator	%overshoot	Peak time,s.	Settling time,s.	Phase margin °
Classical phase lead	1	4.3	3.7	41 at 2.06rad/s
Cancellation phase lead	13	2.1	4.1	47 at 1.65rad/s

Table 7.3a Summary for Example 7.1

Compensator	%overshoot	Peak time,s.	Settling time,s.	Phase margin °
Classical phase lead	0	n/a.	3.3	41 at 2.06rad/s
Cancellation phase lead	4	1.9	2.3	47 at 1.65rad/s

Table 7.3b Summary for Example 7.2

The settling times are comparable with those for the compensator in the error channel but the overshoots are lower. This is typical and due to the fact that when the lead compensator is in the feedback path the zero in the closed loop transfer function occurs at a higher frequency.

Trust and responsibility

NNE and Pharmaplan have joined forces to create NNE Pharmaplan, the world's leading engineering and consultancy company focused entirely on the pharma and biotech industries.

Inés Aréizaga Esteva (Spain), 25 years old
Education: Chemical Engineer

– You have to be proactive and open-minded as a newcomer and make it clear to your colleagues what you are able to cope. The pharmaceutical field is new to me. But busy as they are, most of my colleagues find the time to teach me, and they also trust me. Even though it was a bit hard at first, I can feel over time that I am beginning to be taken seriously and that my contribution is appreciated.



NNE Pharmaplan is the world's leading engineering and consultancy company focused entirely on the pharma and biotech industries. We employ more than 1500 people worldwide and offer global reach and local knowledge along with our all-encompassing list of services. nnepharmaplan.com

nne pharmaplan®



Example 7.4

A control system has a plant with a transfer function of $G(s) = 0.5\omega_o^2 / s(s^2 + 2\zeta s\omega_o + \omega_o^2)$ and $H(s) = 1$. The design specifications are to design a series compensator to keep approximately the same open loop bandwidth as that with a unit gain compensator and a step response with an overshoot of no more than 25% assuming that the parameters ω_o and ζ , which are not known very accurately are 1 and 0.1, respectively. Is the system stable if $G_c(s) = 1$? The designer chooses a P-Z cancellation compensator for the feedforward path with transfer function $G_c(s) = (s^2 + 0.2s + 1)/(1 + sT)^2$. Determine a suitable value of T and from Matlab obtain the percentage overshoot and settling time for the closed loop step response and the phase and gain margins. What are the overshoot and settling time if the compensator is placed in the feedback path? Because of the uncertainty about the parameters the designer examines the performance as ζ varies. Calculate the minimum value of ζ for which the system will be stable and the overshoot, settling time and phase margin for $\zeta = 0.05$. The designer obtains further results for the step response and phase margin for both $\zeta = 0.1$, the nominal value, and $\zeta = 0.05$, with $\omega_o = 0.8$ and, $\omega_o = 1.2$. What do you conclude from these results?

With no compensator, that is $G_c(s) = 1$ the closed loop characteristic polynomial is $s^3 + 0.2s^2 + s + 0.5 = 0$ so the system is unstable as applying the Routh criterion $0.5 > 0.2 \times 1.0$. Since the design must achieve approximately the same open loop bandwidth a suitable choice for T is unity, so that $G_c(s) = (s^2 + 0.2s + 1)(1 + s)^2$ and $G_c(s)G(s) = 0.5/s(1 + s)^2$ with ideal pole-zero cancellation. The step response gives an overshoot of 25% at a time of 6.72s, a settling time of 19s and the system phase and gain margins are 44.1° at 0.424 rad/s and 12dB at 1.00rad/s, respectively. If the compensator is placed in the feedback path the overshoot is 91% at a time of 4.8s and the settling time is 36s.

If the damping is unknown the compensated open loop transfer function is $G_c(s)G(s) = \frac{(s^2 + 0.2s + 1)}{(s + 1)^2} \frac{0.5}{s(s^2 + 2\zeta s + 1)}$. The phase shift of the plant transfer function is -180° at the frequency of 1rad/s. where it has a gain of $0.5/2\zeta$. At this frequency the compensator has no phase shift and a gain of $0.2/2$, which is 0.1. Thus the compensated system has a gain of $1/40\zeta$ at a phase -180° , so that for stability $40\zeta > 1$ giving $\zeta > 0.025$.

The results for the step responses are summarised in Table 7.4

Res. frequency	Damping factor	Overshoot	Settling time	Phase margin°
1.0	0.1	25% at 6.7s	19s	44 at 0.424rad/s
1.0	0.05	20 at 6.3s	24s	47 at 0.425rad/s
0.8	0.1	51% at 7s	124s	35 at 0.485rad/s
0.8	0.05	unstable		16 at 0.696 rad/s
1.2	0.1	26 % at 7.7s	19s	47. at 0.406rad/s
1.2	0.05	25% at 8.1s	54s	49 at 0.406rad/s

Table 7.4 Summary of step response results.

From the tabulated results several interesting aspects can be seen although examination of the complete step responses and Bode or Nyquist diagrams yield further interesting aspects. First for the fourth case in the Table the system goes unstable, although the phase margin given by Matlab does not reveal this. In fact the gain goes through unity at two frequencies and Matlab computes the phase margin from the lowest frequency. The gain margin is negative so this confirms the instability. The settling time for the closed loop step response often increases significantly due to oscillations resulting from the resonant poles not being cancelled by the zeros of the compensator. The effect of overestimating the resonant frequency of the plant poles has the most significant effect on the resulting behaviour.

Example 7.5

A plant with a transfer function of $G(s) = 2(1-s)/(1+s)^2$ is required to be controlled in closed loop with a PI controller, with transfer function $G_c(s) = K_i(1 + (1/sT_i))$, to provide a good response to set point changes. Compare controller designs using the following methods and comment on your results.

- The zero of the controller is used to cancel a plant pole and then K_i is chosen using the root locus approach to place the closed loop poles to give (i) two real and equal poles and (ii) complex poles with a damping ratio of 0.6.
- Use of the Ziegler-Nichols rules $\{K_i = 0.45K_c$ and $T_i = 0.8T_c$ where K_c and T_c are respectively the critical gain and the critical period of the plant}.
- The critical frequency, $\omega_c = 2\pi / T_c$, is placed at the point $0.40 / -195^\circ$ on the compensated Nyquist plot.
- Simulation is used to determine the K_i and T_i which minimise the ISTE.

(a) The transfer function of the controller is $G_c(s) = K_i[(1 + sT_i)/sT_i]$ so that for its zero to cancel a plant pole $T_i = 1$, giving the open loop transfer function $2K_i(1-s)/s(1+s)$. Thus, since the transfer function is second order it is easy to evaluate the required gains from the characteristic equation $s^2 + s(1 - 2K_i) + 2K_i = 0$. This shows that the system is stable for $K_i < 0.5$; that equal roots will occur for $K_i = 0.0858$ (the breakaway point of the root locus from the negative real axis) and roots for a damping ratio of 0.6 for $K_i = 0.1603$. Thus using approximate values the required PI controller transfer functions have (i) $K_i = 0.086, T_i = 1$ and (ii) $K_i = 0.16, T_i = 1$.

(b) The plant has a frequency response $G(j\omega) = 2(1 - j\omega)(1 + j\omega)^2$ from which it is easily seen that the critical frequency is $\omega_c = 1.732$ and the corresponding gain is unity. $T_c = 2\pi/1.732 = 3.63$ so that from the rules $T_i = 0.8 \times 3.63 = 2.90$ and $K_i = 0.45$.

(c) For this case the PI controller must give a gain of 0.40 and a phase lag of 15° at the critical frequency of 1.732 rad/s . Thus $\tan^{-1} \omega_c T_i = 75^\circ$ giving $T_i = 2.15$ and $\frac{K_i(1 + \omega_c^2 T_i^2)^{1/2}}{\omega_c T_i} = 0.4$ so that $K_i = 0.386$.

(d) Since only two parameters are to be adjusted to minimise the ISTE this can be done by iteration with the Simulink block diagram shown in Figure 7.3. The results are $K_i = 0.42$ and $T_i = 2.21$.

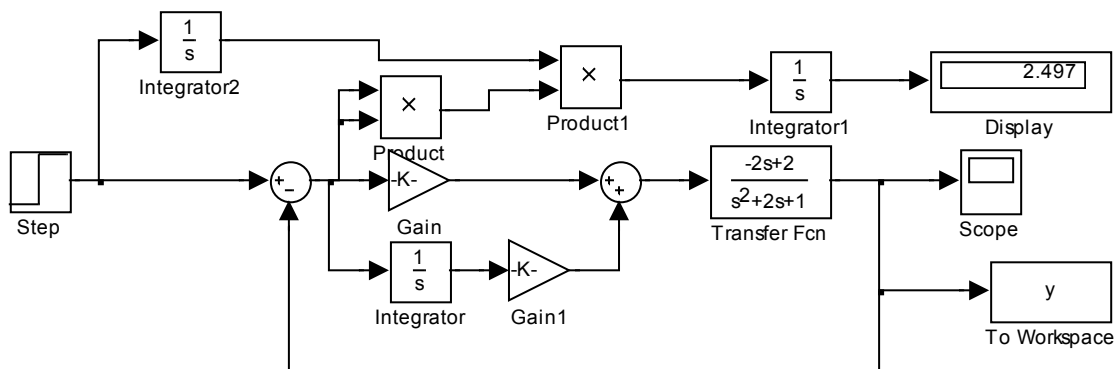

Figure 7.3 Simulink diagram for evaluation of ISTE

The results are summarised in Table 7.5 together with the important descriptors of the closed loop step response and open loop frequency response.

Case	K_i	T_i	Overshoot	Settling time	Phase margin°	Gain margin dB
a(i)	0.086	1.0	No	14.9s	71 at 0.172	15.3 at 1.0
a(ii)	0.16	1.0	10% at 7.7s	11.3s	54 at 0.320	9.9 at 1.0
b	0.45	2.90	3% at 3.7s	14.2s	67 at 0.481	5.8 at 1.46
c	0.39	2.15	7% at 4.3s	9.5s	60 at 0.466	6.2 at 1.36
d	0.42	2.21	10% at 4.1s	9.3s	58 at 0.489	6.0 at 1.35

Table 7.5

The designs trade off speed of response, which if fast will result in an overshoot, against a longer settling time. The low value of K_i in design a(i) results in a slow response with no overshoot and has the largest gain and phase margins. If a small overshoot is allowed then designs (b) and (c) would probably be preferred.

This e-book
is made with
SetaPDF





SETASIGN

PDF components for PHP developers

www.setasign.com



Example 7.6

A process has a transfer function of $G(s) = 2/(1+s)(1+0.2s)^2$ which is to be controlled in a feedback loop with $H(s) = 1$ and a PID controller with transfer function $G_c(s) = K\{1 + (1/sT_i) + (sT_d/1 + \alpha sT_d)\}$, with $\alpha = 0.1$. What are the critical gain, K_c , and frequency, ω_c , of the plant? It is required to achieve a set point step response with an overshoot of no more than 20% and a settling time of 2 seconds. What are the results from the following two design approaches?

- Use of the Ziegler - Nichols tuning parameters, $K = 0.6K_c$, $T_i = 0.5T_c$ and $T_d = 0.125T_c$, where $T_c = 2\pi / \omega_c$.
- Assuming $\alpha = 0$ in $G_c(s)$ the critical frequency is moved to the point $0.7/_-135^\circ$ on the compensated Nyquist locus. Give the calculated values of K and T_d to do this assuming $T_i = 4T_d$.

From Matlab the gain margin is 17.1dB at 5.92 rads/s and the phase margin 89.1° at 1.53 rads/s. The gain corresponding to 17.1dB is $10^{17.1/20} = 7.16$. Thus $K_c = 7.16$ and $\omega_c = 5.92$.

(a) $T_c = 2\pi / 5.92 = 1.06$ so that from the Z-N rules $K = 0.6 \times 7.16 \approx 4.3$, $T_i = 0.5T_c = 0.53$ and $T_d \approx 0.13$. Substituting these values in the given transfer function $G_c(s)$ for the PID controller gives $G_c(s) = \frac{4.3(0.0758s^2 + 0.543s + 1)}{0.00689s^2 + 0.53s}$. For this controller the system has a gain margin of 19.9dB at 16.9rads/s, a phase margin of 26.8 at 4.71 rads/s and a closed loop step response with an overshoot of 51% at 0.64s and a settling time of 2.8s.

(b) With $\alpha = 0$ and $T_i = 4T_d$ the transfer function of the controller is $G_c(s) = K(1 + 2sT_d)^2 / 4sT_d$ and to satisfy the required phase condition of the design it must have a phase shift of 45° at ω_c . Thus $45^\circ = -90^\circ + 2 \tan^{-1} 2\omega_c T_d$ giving $T_d = 0.204$. To satisfy the gain condition $|G_c(j\omega_c)| |G(j\omega)| = 0.7$ which gives $\frac{1}{7.16} \frac{K(1 + 4\omega_c^2 T_d^2)}{4\omega_c T_d} = 0.7$, yielding $K = 3.54$ after substituting for ω_c and T_d . Taking $T_d = 0.20$ and $T_i = 0.82$ gives the controller transfer function $G_c(s) = \frac{3.54(0.180s^2 + 0.84s + 1)}{0.0164s^2 + 0.82s}$.

With this controller the system has a gain margin of 19.3dB at 17.8rads/s, a phase margin of 47.2° at 4.70 rads/s and a closed loop step response with an overshoot of 24% at 0.62s and a settling time of 1.1s.

Thus neither controller design meets the step response criterion. However approach (b) meets the settling time criterion and several modifications are possible which might achieve the design criterion. One possibility is to feed the derivative term from the output rather than the error but this results in a larger overshoot and a longer settling time. A second possibility is to just keep the integral term in the error channel and feed both the proportional and derivative terms from the output as this delays the effect of the step input at the input to the plant. This results in $G_c(s) = 3.54/0.8s$ and $G_{cf}(s) = \frac{3.54(1+0.22s)}{1+0.02s}$ fed from the output. In this case the system has a gain margin of 13dB at 4.43 rad/s, a phase margin of 68.4° at 1.08 rad/s and a closed loop step response with no overshoot and a settling time of 2.1s. This roughly satisfies the criterion which can be achieved by minor modifications of the parameters. A third approach is to move the critical point in the approach of (b). Since the settling time for the design was easily achieved a gain reduction should reduce the overshoot, so the critical frequency can be moved from $0.7/_{-135^\circ}$ to $0.55/_{-135^\circ}$ giving a controller gain $K = 2.75$. Thus taking $G_c(s) = \frac{2.75(0.180s^2 + 0.84s + 1)}{0.0164s^2 + 0.82s}$ gives a system with a gain margin of 21.5dB at 17.8 rad/s, phase margin of 52.3° at 3.84 rad/s and a closed loop step response with overshoot of 19% at 0.72s and a settling time of 1.5s.

Finally another possibility would be to use a PI-PD controller where a proportional term is included in both the error channel and the feedback path.

Example 7.7

A plant has a transfer function of $G(s) = 2/s\{1 + (2\zeta s/\omega_o) + (s^2/\omega_o^2)\}$ with $\zeta = 1.25$ and $\omega_o = 2.5$. It is to be controlled in a feedback loop with $H(s) = 1$ and a compensator $G_c(s)$ in the error channel. What are the gain and phase margins if $G_c(s) = 1$. Design a phase lead compensator with unit gain at zero frequency to give a phase margin of around 45° and give the gain crossover frequencies of the uncompensated and compensated open loop frequency responses. Unfortunately there is considerable uncertainty about the damping ratio, ζ , and it is believed it might get as small as half the assumed value. If this is the case what will be the phase margin of the system. Investigate the design of a compensator to achieve the required value of phase margin for both values of damping.

For the given $G(s)$ the gain margin is 9.9dB at 2.5rad/s and the phase margin is 28.5° at 1.33rad/s. Since the plant gain falls off quickly to achieve a phase margin of 45° the compensator will probably have to provide a lead of at least 30° . Taking $\alpha = 1/3$ gives a gain of 4.77dB and a maximum phase lead of 30° . $G(s)$ is approximately 4.77dB down at 1.83rad/s so $T = \sqrt{3}/1.83 = 0.95$ giving $G_c(s) = \frac{1 + 0.95s}{1 + 0.32s}$. This compensator only results in producing a phase margin of 43.9° at 1.83 rad/s for the system. Trying $\alpha = 1/4$ results in $G_c(s) = \frac{1 + s}{1 + 0.25s}$ and a system with a phase margin of 47.7° at 1.97rad/s. The required gain crossover frequencies are 1.33 and 1.97rad/s, respectively. The closed loop step response of the compensated system gives an overshoot of 20% at 1.43s and a settling time of 3.3s.

When the compensator is used for the plant with damping reduced by 50% the gain margin is 3.06dB at 3.67rad/s and the phase margin is 14.6° at 1.32rad/s. The closed loop step response is very oscillatory with an overshoot of 41% at 1.23s and a settling time of 14.6s. {NOTE. If the main concern for the results with the reduced damping is the poor step response, not the phase margin, then one could investigate the performance with the lead controller in the feedback path. If this is done then for the nominal damping the step response has no overshoot and a settling time of 4.6s and for the reduced damping an oscillatory behaviour along a time constant so that the first overshoot is 5% at 3.23s and the second 6% at 5.13s with a settling time of 10.9s. Possibly an acceptable design.}



FOSS

Sharp Minds - Bright Ideas!

Employees at FOSS Analytical A/S are living proof of the company value - First - using new inventions to make dedicated solutions for our customers. With sharp minds and cross functional teamwork, we constantly strive to develop new unique products - Would you like to join our team?

FOSS works diligently with innovation and development as basis for its growth. It is reflected in the fact that more than 200 of the 1200 employees in FOSS work with Research & Development in Scandinavia and USA. Engineers at FOSS work in production, development and marketing, within a wide range of different fields, i.e. Chemistry, Electronics, Mechanics, Software, Optics, Microbiology, Chemometrics.

We offer
A challenging job in an international and innovative company that is leading in its field. You will get the opportunity to work with the most advanced technology together with highly skilled colleagues.

Read more about FOSS at www.foss.dk - or go directly to our student site www.foss.dk/sharpminds where you can learn more about your possibilities of working together with us on projects, your thesis etc.

Dedicated Analytical Solutions

FOSS
 Slangerupgade 69
 3400 Hillerød
 Tel. +45 70103370
www.foss.dk











Click on the ad to read more

A phase margin of 45° cannot be achieved for the plant transfer function with the reduced damping with a lead compensator so that if speed of response is not a factor then a phase lag compensator can be used. The Bode diagrams for the two plant transfer functions are shown in Figure 7.4. As the phase shift of the nominal plant (larger damping) is greater initially the phase lag network needs to be designed for this transfer function. The transfer function has a phase lag of around -130° at 0.77rad/s where the gain is about $6.87\text{dB}=2.20$. An approximate phase lag with $T = 1/0.077 \approx 13$ is $G_c(s) = \frac{1+13s}{1+28s}$ which gives a phase margin of 46.1° at 0.781rad/s with the nominal plant and 58.5° at 0.952 rad/s with the plant with the reduced damping. The closed loop step responses for the two cases have overshoots of 24% at 3.66s and 12% at 2.7s, and settling times of 13s and 14s, respectively.

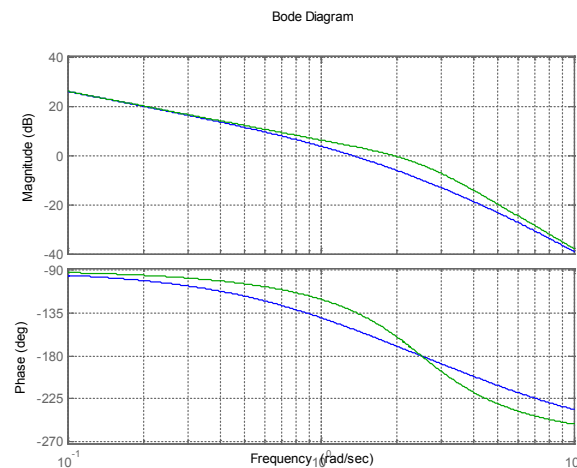

Figure 7.4 Frequency responses for plant transfer functions. (nominal plant blue)

Example 7.8

A plant has a transfer function $G(s) = (1+s)/s(s^2-4)$ and is to be controlled in a loop with unit negative feedback by the phase lead compensator $G_c(s) = K(1+s)/(1+0.1s)$. Plot a root locus for the system and find the approximate value of K to give a minimum overshoot to an input step.

The open loop transfer function $G_c(s)G(s) = \frac{K(1+s)^2}{s(s^2-4)(1+0.1s)}$ which has two zeros at -1 and poles at 0, 2, -2 and -10. This is an unstable transfer function due to the pole at 2. The basic rules for the root locus indicate there will be a locus on the real axis between the poles at 2 and 0 and between the poles -2 and -10. The excess of poles over zeros is 2 so there are two locus branches which tend to infinity along an asymptote cutting the real axis at -4. The locus starts at poles and finishes at zeros so that there will be two breakaway points from the real axis one between 2 and 0 and the other between -2 and -10. The two loci from the former will finish at the two zeros at -1. The root locus from Matlab is shown in Figure 7.5. Two points are marked, one shows that the system becomes stable for $K > 2.64$ and the other that the breakaway point between the roots -2 and -10 occurs for a gain $K = 3.29$.

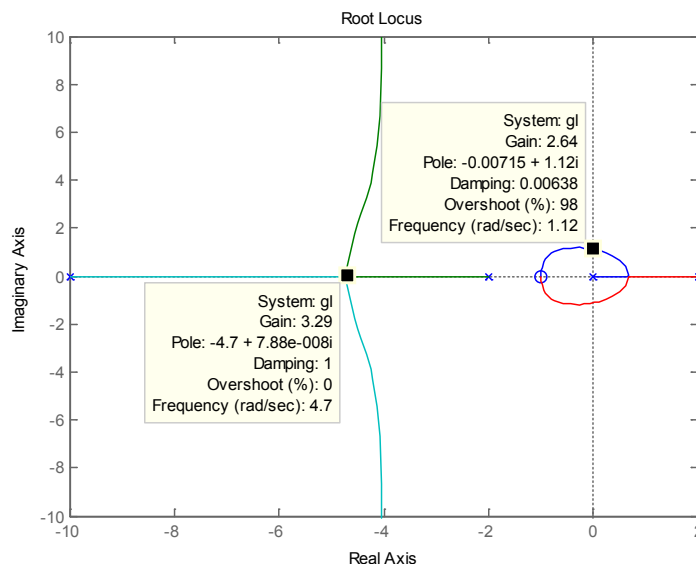

Figure 7.5 Root locus plot

Thus whatever the choice of K there will be 4 complex poles. There is little change in the overshoot for the step response for gains K over quite a significant range as shown in Figure 7.6 for gains of 10, 20 and 30, respectively. The minimum overshoot of around 51% occurs for $K = 12$.

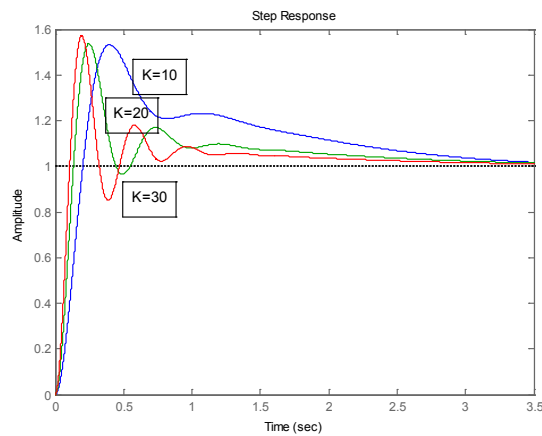

Figure 7.6 Closed loop step responses for different gains.

Example 7.9

A feedback system has a plant with a transfer function $G(s) = K / s(1 + 0.5s)(1 + 0.125s)$ and $H(s) = 1$. Determine the maximum value of K for the system to be stable. If K is half this value; design a phase lead compensator of the form $G_c(s) = (1 + sT) / (1 + 0.125s)$ to achieve a maximum phase margin. Give details of the resulting closed loop step response if the compensator is placed (a) in the error channel and (b) in the feedback path. Find using simulation the optimum values of T to minimise the ISTE (Integral of the square of time times error) for cases (a) and (b). Give details of the corresponding step responses.

A hand calculation to evaluate the required value of T is extremely time consuming but with Matlab a solution can easily be obtained by trial and error using the margin command. The optimum value of T is around 0.47 and it results in a phase margin of 37.7° . The closed loop step response for (a) results in an overshoot of 34% at 0.67s and a settling time of 2.4s and for (b) an overshoot of 1% at 1.01s and a settling time of 2.0s.

A simulation diagram for evaluating the ISTE is shown in Figure 7.7 for the compensator in the forward path. The optimum values of T are 0.60 and 0.44, respectively, and the value of the ISTE is about 12% smaller for case (b). The step response has an overshoot of 34% at 0.80s and a settling time of 2.53s for case (a) and 5% at 1.06s and settling time of 2.03s for case(b).

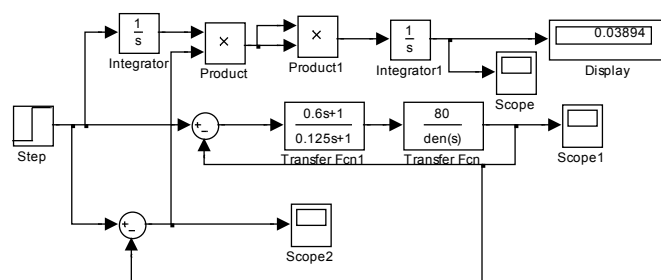

Figure 7.7 Simulink diagram for ISTE evaluation.

Example 7.10

A process with a transfer function of $G(s) = 4e^{-s} / (1 + s)$ is to be controlled in a feedback loop with $H(s) = 1$ and a PID controller with transfer function $G_c(s) = K \{1 + (1/sT_i) + (sT_d/1 + \alpha sT_d)\}$, with $\alpha = 0.1$. What are the critical gain, K_c , and frequency, ω_c , of the plant? What are the results from the following three design approaches?

- Use of the Ziegler – Nichols tuning parameters, $K = 0.6K_c$, $T_i = 0.5T_c$ and $T_d = 0.125T_c$, where $T_c = 2\pi / \omega_c$.
- The critical frequency is moved to the point $0.6/_-135^\circ$ on the compensated Nyquist locus. Give the calculated values of K and T_d to do this assuming $\alpha = 0$ and $T_i = 4T_d$.
- The critical frequency is moved to the point $0.6/_-135^\circ$ on the compensated Nyquist locus. Give the calculated values of K and T_d to do this assuming $\alpha = 0$ and $T_i = 8T_d$.

The phase shift of the plant frequency response is $-\omega - \tan^{-1} \omega$ which gives -180° when $\omega = \omega_c = 2.03$ rads/s and the corresponding gain $|G(j\omega)| = \frac{4}{(1 + 2.03^2)^{1/2}} = 1.77$ so that $K_c = 1/1.7 = 0.566$.



“I studied English for 16 years but...
...I finally learned to speak it in just six lessons”
Jane, Chinese architect

ENGLISH OUT THERE

Click to hear me talking before and after my unique course download

(a) Since $T_c = 2\pi / \omega_c = 2\pi / 2.03 = 3.10$ the Z-N parameters are $K = 0.34$, $T_i = 1.55$, and $T_d = 0.39$. The controller transfer function is $G_c(s) = \frac{K[s^2(1 + \alpha)T_iT_d + s(T_i + \alpha T_d) + 1]}{s^2\alpha T_iT_d + sT_i} = \frac{0.34(0.665s^2 + 1.59s + 1)}{0.0605s^2 + 1.55s}$. For the resulting system the gain and phase margins are 3.85dB at 2.53rads/s and 63.2° at 1.01 rads/s. The Matlab 'feedback' function cannot be used when a transfer function in it contains a delay. If desired approximate results can be obtained using this function and approximating any delay in a transfer function by its Pade approximation. Alternatively the system can be simulated in Simulink which gave a closed loop step response with an overshoot of 37% at 1.9s and a settling time of 9.2s.

(b) With $\alpha = 0$ and $T_i = 4T_d$ the transfer function of the controller is $G_c(s) = K(1 + 2sT_d)^2 / 4sT_d$ and to satisfy the required phase condition of the design it must have a phase shift of 45° at ω_c . Thus $45^\circ = -90^\circ + 2 \tan^{-1} 2\omega_c T_d$ giving $2\omega_c T_d = 2.414$ so that $T_d = 0.5946$. To satisfy the gain condition $|G_c(j\omega_c)| = 0.6$ which gives $\frac{1}{0.566} \frac{K(1 + 4\omega_c^2 T_d^2)}{4\omega_c T_d} = 0.6$, yielding $K = 0.2401$ after substituting for ω_c and T_d . Taking $K = 0.24$, $T_d = 0.59$ and $T_i = 2.36$ gives the controller transfer function $G_c(s) = \frac{0.24(1.531s^2 + 2.42s + 1)}{0.139s^2 + 2.36s}$. The resulting system has gain and phase margins of 4.11dB at 2.77rads/s and 96.1° at 0.491 rads/s, respectively. The closed loop step response is oscillatory but has no overshoot and a settling time of 12s.

(c) With $\alpha = 0$ and $T_i = 8T_d$ the transfer function of the controller is $G_c(s) = K(1 + 8sT_d + 8s^2T_d^2) / 8sT_d$ which gives $G_c(j\omega) = K(1 + 8j\omega T_d - 8\omega^2 T_d^2) / 8j\omega T_d$ and as in (b) the numerator must provide a phase lead at the critical frequency of 135°, thus $\tan^{-1}[8\omega_c T_d, (1 - 8\omega_c^2 T_d^2)] = 135^\circ$ which gives $T_d = 0.55$ and $T_i = 4.4$. The gain $K = 0.24$, as before, and the controller transfer function is $G_c(s) = \frac{0.24(2.68s^2 + 4.46s + 1)}{0.242s^2 + 4.40s}$. The resulting system has gain and phase margins of 4.27dB at 2.77rads/s and 116° at 0.35 rads/s, respectively. The closed loop step response is oscillatory but has no overshoot and a settling time of 26s.

Example 7.11

A feedback system has a plant with a transfer function $G(s) = 1/s(1+s)(1+0.1s)$ and $H(s) = 1$. It is required to design a controller $G_c(s)$ so that the closed loop step response does not have an overshoot greater than 10%. Use the root locus approach to find the required controller gain if (a) $G_c(s) = K$ and (b) $G_c(s) = K(1+s)/(1+0.1s)$. Obtain the closed loop step responses and comment on their relative behaviour.

Figure 7.8 shows the root locus plot using a gain range of 0-12 for case (a), where the complex roots cross the axis for $K = 11$, with an estimated gain value of 0.605 for around 10% overshoot. Since the real pole is still at approximately -10 its contribution to the closed loop step response is expected to be small. The closed loop step response has an overshoot of 9% at 5.2s and a settling time of 7.8s. For case (b) a difficulty in designing a phase lead compensator using the root locus is to have a strategy for choosing its zero and pole, and one simple method is the zero-pole cancellation used here. Again a point with damping around 0.6 for the complex poles is selected. A gain of 3.03 gives complex pole damping of 0.596 with an overshoot of 9.73%. The real part of the complex poles is around -2.7 and the real pole is at approximately -14.6 so its effect on the closed loop step response is again expected to be small. The closed loop step response has an overshoot of 9% at 0.93s and a settling time of 1.36s. The two step responses are quite similar but the speed of response is increased by a factor of more than five with the lead compensator.

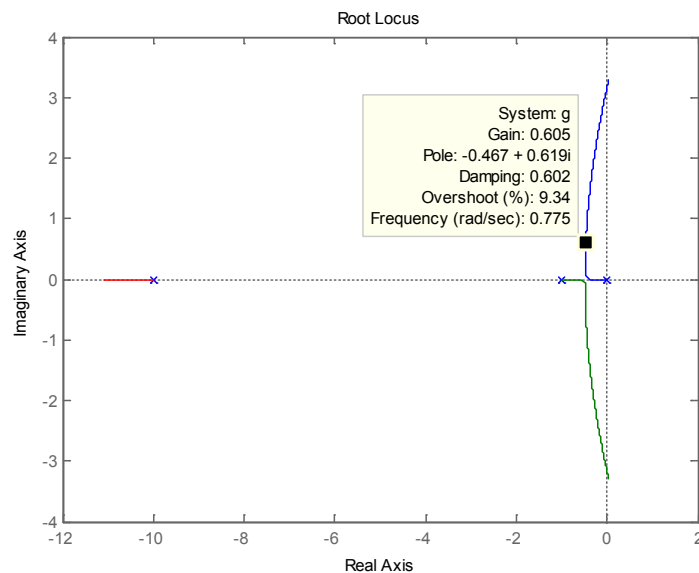
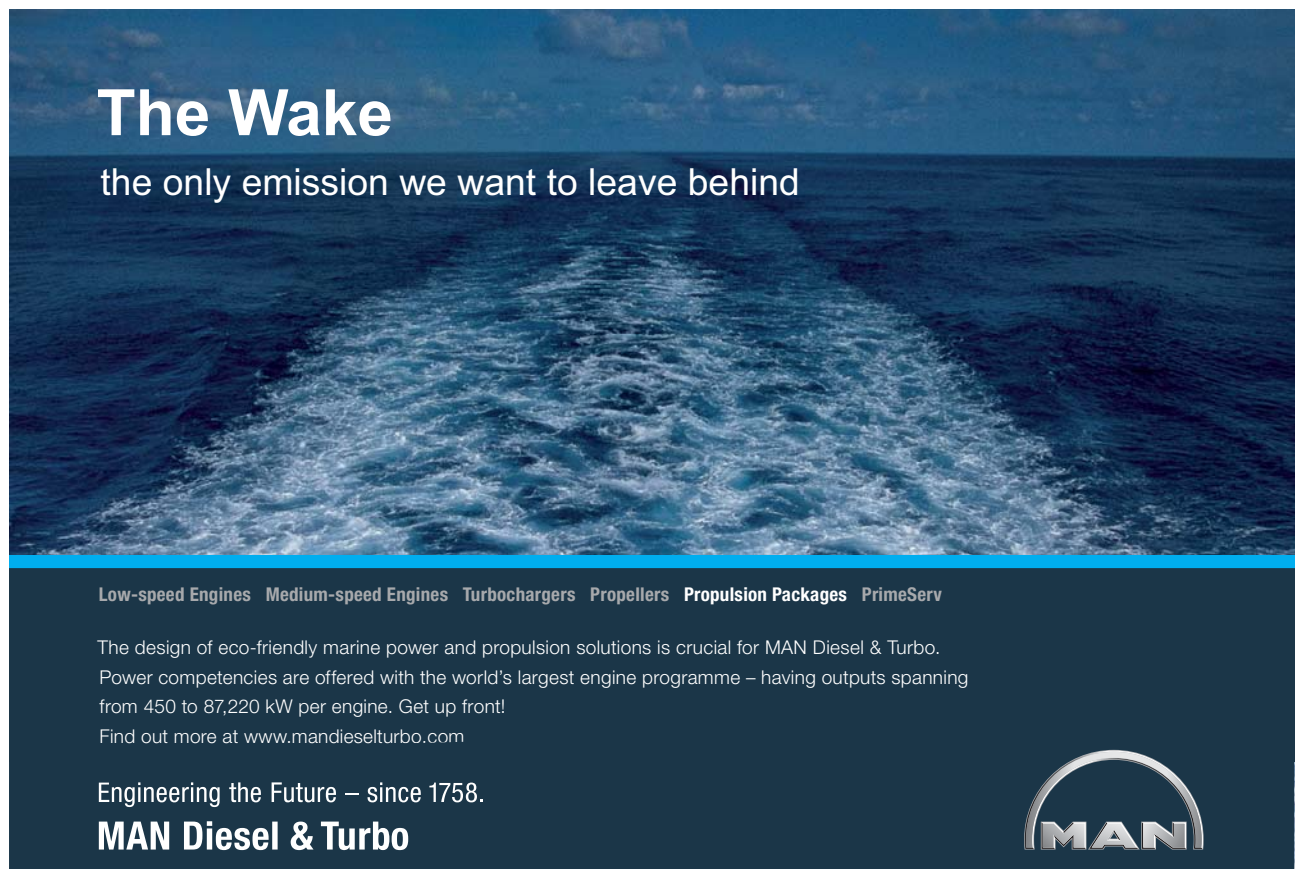

Figure 7.8 Root locus plot.

Example 7.12

A relay autotuning experiment was performed on a process, with a relay having an output of ± 1 , and the values obtained for the amplitude of the limit cycle and its frequency at the relay input were 0.64 and 1.0 rads/s, respectively. It was decided to control the process with an ideal PID controller in the error channel and to select the controller parameters so that the integral time constant was four times the derivative time constant and the frequency of 1.0 rads/s occurred at a gain of 0.5 and a phase of -150° on the compensated Nyquist locus. What are the required values for the controller gain and derivative time constant.

The gain through the relay for the limit cycle is $4h/a\pi = 4/0.64\pi = 0.5027 \approx 0.5$ which is the estimate from DF analysis for the critical gain, K_c . Now $K_c G_c(j\omega_c)$ must have a gain of 0.5, thus $|G_c(j\omega_c)| = 1$, and a phase shift of $180^\circ - 150^\circ = 30^\circ$. Now $G_c(s) = K(1 + \frac{1}{sT_i} + sT_d) = \frac{K(s^2 T_i T_d + sT_i + 1)}{sT_i} = \frac{K(1 + 2sT_d)^2}{4sT_d}$ with $T_i = 4T_d$, therefore $-90^\circ + 2 \tan^{-1} 2\omega_c T_d = 30^\circ$ giving $\tan^{-1} 2\omega_c T_d = 60^\circ$ so that $2\omega_c T_d = \sqrt{3}$ and on substituting for ω_c gives $T_d = 0.866$. Now $|G_c(j\omega_c)| = \frac{K(1 + 4\omega_c^2 T_d^2)}{4\omega_c T_d} = \frac{K(1+3)}{2\sqrt{3}} = \frac{2K}{\sqrt{3}}$ which equals unity for $K = 0.866$.



The Wake
the only emission we want to leave behind

Low-speed Engines Medium-speed Engines Turbochargers Propellers Propulsion Packages PrimeServ

The design of eco-friendly marine power and propulsion solutions is crucial for MAN Diesel & Turbo. Power competencies are offered with the world's largest engine programme – having outputs spanning from 450 to 87,220 kW per engine. Get up front! Find out more at www.mandieselturbo.com

Engineering the Future – since 1758.
MAN Diesel & Turbo



Click on the ad to read more

Example 7.13

Here the use of state feedback control is considered to improve the control of the plant transfer function given in Example 7.4, where it was seen that problems arose with a series compensator design when the plant parameters varied. The Simulink diagram for the transfer function is given in Figure 7.9, where it is assumed that the states are the output of the integrators and that feedback is only possible to the plant input. The Gain and Gain1 blocks show the nominal value of unity for ω_o and the Gain3 block is $2\zeta\omega_o$ with the nominal value of $\zeta = 0.1$ entered. The resulting system, as in Example 4, is required to have zero steady state error to a step input. {NOTE:- If the physical structure of the plant had the integrator after the second order dynamics the design would be easier as no feedback need be used around it and the integrator would ensure zero steady state error to a step input. The same reasoning would apply for the situation of Figure 7.9 if it were possible to feedback into the plant at the output of the block labelled Integrator2.}

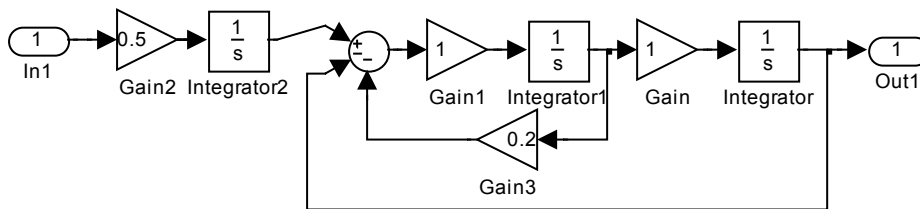

Figure 7.9 Simulink model of state variable representation.

The state space description for the plant is

$$A = \begin{pmatrix} 0 & \omega_o & 0 \\ -\omega_o & -2\zeta\omega_o & \omega_o \\ 0 & 0 & 0 \end{pmatrix}, B = \begin{pmatrix} 0 \\ 0 \\ 1 \end{pmatrix} \text{ and } C = (1 \ 0 \ 0), D = 0. \text{ \{NOTE the } A \text{ matrix is singular\}.}$$

Assuming the feedback is such that $u = 0.5r - 0.5(k_1 \ k_2 \ k_3) \begin{pmatrix} 0 \\ 0 \\ 1 \end{pmatrix}$, then the new A matrix is

$$A_f = \begin{pmatrix} 0 & \omega_o & 0 \\ -\omega_o & -2\zeta\omega_o & \omega_o \\ -0.5k_1 & -0.5k_2 & 0.5k_3 \end{pmatrix}, \text{ which leads to } sI - A_f = \begin{pmatrix} s & -\omega_o & 0 \\ \omega_o & s + 2\zeta\omega_o & -\omega_o \\ 0.5k_1 & 0.5k_2 & s + 0.5k_3 \end{pmatrix} \text{ and the characteristic}$$

equation $|sI - A| = s^3 + s^2(2\zeta\omega_o + 0.5k_3) + s(\zeta\omega_o k_3 + 0.5\omega_o k_2 + \omega_o^2) + 0.5\omega_o^2(k_1 + k_3) = 0.$

A transfer function with an integration term is required in front of the plant to produce a zero steady state error to a step input, so if this is chosen as $(s + 1)/s$ and the feedback gains are chosen to place the three poles of the characteristic equation at -1, then the nominal forward path transfer function is $\frac{0.5}{s(s + 1)^2}$ which is in agreement with the design using the series compensator in Example 7.4. The resulting system is shown in Figure 7.10 with the simulation of the nominal transfer function in parallel, which allows one to check that the feedback gains have been correctly calculated and also to compare results with those of the nominal system when the plant parameters are varied. The required gain values are:- $k_1 = -3.6$, $k_2 = 2.88$ and $k_3 = 5.6$.

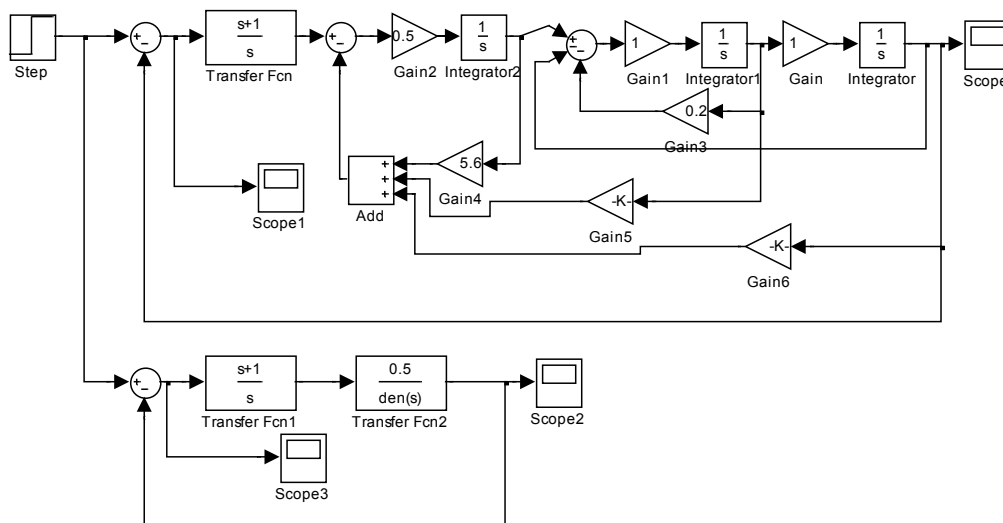

Figure 7.10 State feedback design.

Using the same parameter variations as Example 7.4 the step response results, equivalent to Table 7.4, are given below in Table 7.6 obtained using the Simulink model of Figure 7.10

Res. frequency	Damping factor	Overshoot	Settling time
1.0	0.1	25% at 6.5s	19s
1.0	0.05	26 at 6.0s	23s
0.8	0.1	39% at 7.0s	37s
0.8	0.05	41% at 7.0s	39s
1.2	0.1	24 % at 7.0s	27s
1.2	0.05	25% at 6.5s	22s

Table 7.6 Summary of step response results.

It can be seen from Table 7.6 that the step responses are not now as sensitive to the parameter changes and the system remains stable for $\omega_o = 0.8$ and $\zeta = 0.05$. Indeed for this value of damping factor the system will remain stable until the resonant frequency is less than half the nominal value. This is expected due to the ability of the three feedback gains to change the three roots of the characteristic equation.

Example 7.14

A system has a state space description of $A = \begin{pmatrix} -7 & 3 \\ -6 & 2 \end{pmatrix}$, $B = \begin{pmatrix} 2 \\ 1 \end{pmatrix}$, $C = (1 \ 0)$, $D = 0$. Calculate the required feedback gains to move both poles to -2 by (i) by direct calculation and (ii) by first transforming the system to the controllable canonical form.

(i) For the given system $sI - A = \begin{pmatrix} s+7 & -3 \\ 6 & s-2 \end{pmatrix}$, therefore $|sI - A| = s^2 + 5s + 4 = (s+1)(s+4)$ and the poles are at -1 and -4, respectively.

For the state feedback $u = r - Bk^T$, where $k^T = (k_1 \ k_2)$ the new A matrix is

$$A_f = A - Bk^T = \begin{pmatrix} -7 & 3 \\ -6 & 2 \end{pmatrix} - \begin{pmatrix} 2 \\ 1 \end{pmatrix} (k_1 \ k_2) = \begin{pmatrix} -7-2k_1 & 3-2k_2 \\ -6-k_1 & 2-k_2 \end{pmatrix}.$$

gaiteye
Challenge the way we run

EXPERIENCE THE POWER OF FULL ENGAGEMENT...

**RUN FASTER.
RUN LONGER..
RUN EASIER...**

**READ MORE & PRE-ORDER TODAY
WWW.GAITEYE.COM**

$$\text{Thus } |sI - A| = \begin{vmatrix} s + 7 + 2k_1 & -3 + 2k_2 \\ 6 + k_1 & s - 2 + k_2 \end{vmatrix} = s^2 + (5 + 2k_1 + k_2)s + 4 - 5k_2 - k_1.$$

For both poles to be at -2, the characteristic equation must be $s^2 + 4s + 4 = 0$ so that the values of the gains must satisfy $5 + 2k_1 + k_2 = 4$ and $4 - 5k_2 - k_1 = 4$, which has the solution $k = (-5/9 \quad 1/9)$.

(ii) The system is controllable as $(B \quad AB) = \begin{pmatrix} 2 & -11 \\ 1 & -10 \end{pmatrix}$ is not singular.

To transform to controllable canonical form we have

$B = t_2$, $At_1 = -a_0t_2$ and $At_2 = t_1 - a_1t_2$, where $a_0 = a_1 = 4$, of which we only need to use two.

Thus using the first two relationships $t_2 = \begin{pmatrix} 2 \\ 1 \end{pmatrix}$, $t_1 = \begin{pmatrix} -7 & 3 \\ -6 & 2 \end{pmatrix}^{-1} \begin{pmatrix} -8 \\ -4 \end{pmatrix} = \begin{pmatrix} -1 \\ -5 \end{pmatrix}$, so that $T = \begin{pmatrix} -1 & 2 \\ -5 & 1 \end{pmatrix}$,

$T^{-1} = \begin{pmatrix} 1/9 & -2/9 \\ 5/9 & -1/9 \end{pmatrix}$, $T^{-1}B = \begin{pmatrix} 1/9 & -2/9 \\ 5/9 & -1/9 \end{pmatrix} \begin{pmatrix} 2 \\ 1 \end{pmatrix} = \begin{pmatrix} 0 \\ 1 \end{pmatrix}$, as required, and $CT = (1 \quad 0) \begin{pmatrix} -1 & 2 \\ -5 & 1 \end{pmatrix} =$

$\begin{pmatrix} -1 & 2 \end{pmatrix}$. For the state feedback $u = r - Bk_c^T$, where $k_c^T = (k_{1c} \quad k_{2c})$ the new A matrix is

$A_{fc} = A_c - B_c k_c^T = \begin{pmatrix} 0 & 1 \\ -4 & -5 \end{pmatrix} - \begin{pmatrix} 0 \\ 1 \end{pmatrix} (k_{1c} \quad k_{2c}) = \begin{pmatrix} 0 & 1 \\ -4 - k_{1c} & -5 - k_{2c} \end{pmatrix}$ with the characteristic

equation $s^2 + (5 + k_{2c})s + 4 + k_{1c} = 0$ so that $k_{1c} = 0$ and $k_{2c} = -1$.

Since $x = Tx_c$ where x is the original state vector and x_c that for the controllable canonical form, then the feedback $k_c x_c = k_c T^{-1}x = kx$, where $k = k_c T^{-1}$, thus $k = (0 \quad 1) \begin{pmatrix} 1/9 & -2/9 \\ 5/9 & -1/9 \end{pmatrix} = (-5/9 \quad 1/9)$, as before.

Example 7.15

A system has a state space description $A = \begin{pmatrix} -15 & -16 & -8 \\ 15 & 17 & 10 \\ -16 & -17 & -8 \end{pmatrix}$, $B = \begin{pmatrix} 1 \\ -1 \\ 1 \end{pmatrix}$, $C = (1 \quad 0 \quad 1)$ and $D = 0$. Determine the transfer function of the system. Find the eigenvalues of A and the transformation matrix T to put

the system into the controllable canonical form, where $A_c = T^{-1}AT$. Use this value of T to obtain the controllable canonical form A_c, B_c, C_c, D_c and confirm that this agrees with the transfer function.

Determine the required feedback gains for the system A, B, C, D to have all its poles at -1 and the corresponding input-output transfer function.

For the transformation to controllable canonical form $B = t_3$, $At_1 = -a_0 t_3$ and $At_2 = t_1 - a_1 t_3$.

From Matlab after entering the system state space description and the command $G = ss(A, B, C, D)$ then the command $tf(G)$ yields the transfer function $\frac{2s^2 - 2s + 3}{s^3 + 6s^2 + 11s + 6}$. Entering $eig(A)$ gives the eigenvalues of A as, -1, -2 and -3, so that the characteristic equation is $s^3 + 6s^2 + 11s + 6 = 0$ giving $a_0 = 6$, $a_1 = 11$ and $a_2 = 6$, and in addition

$$A^{-1} = \begin{pmatrix} -5.6667 & -1.3333 & 4 \\ 6.6667 & 1.3333 & -5 \\ -2.8333 & -0.1667 & 2.5 \end{pmatrix} \text{ so that } t_1 = 6A^{-1}t_3 = \begin{pmatrix} 2 \\ -2 \\ 1 \end{pmatrix} \text{ and } t_2 = A^{-1}t_1 + 11A^{-1}t_3 = \begin{pmatrix} -1 \\ 2 \\ -1 \end{pmatrix}.$$

$$\text{Thus } T = \begin{pmatrix} 2 & -1 & 1 \\ -2 & 2 & -1 \\ 1 & -1 & 1 \end{pmatrix}, T^{-1} = \begin{pmatrix} 1 & 0 & -1 \\ 1 & 1 & 0 \\ 0 & 1 & 2 \end{pmatrix} \text{ and } T^{-1}AT = A_c = \begin{pmatrix} 0 & 1 & 0 \\ 0 & 0 & 1 \\ -6 & -11 & -6 \end{pmatrix} \text{ as expected.}$$

Further $B_c = T^{-1}B = \begin{pmatrix} 0 \\ 0 \\ 1 \end{pmatrix}$, $C_c = CT = (3 \quad -2 \quad 2)$ and $D_c = D = 0$ as expected to yield the known transfer function for G . The required characteristic equation after feedback is $s^3 + 3s^2 + 3s + 1 = 0$

so that the required feedback gains for the controllable canonical form are given from $6 + k_{1c} = 1$,

$11 + k_{2c} = 3$ and $6 + k_{2c} = 3$ so that $k_c^T = (-5 \quad -8 \quad -3)$. Thus the feedback required from the states

of A, B, C, D is

$$k_c^T T^{-1} = (-5 \quad -8 \quad -3) \begin{pmatrix} 1 & 0 & -1 \\ 1 & 1 & 0 \\ 0 & 1 & 2 \end{pmatrix} = (-13 \quad -11 \quad -1). \text{ The corresponding input-output transfer function is } \frac{2s^2 - 2s + 3}{(s+1)^3}.$$

{Note:- Pole placement can be done directly in Matlab using the expression $k = place(A, B, p)$ where p is the vector of the required pole locations. However, the algorithm does not work when the multiplicity of a pole in p is greater than the rank of B . A simple check can obviously be made by putting all three poles near to -1, so choosing $p = [-1, -1.01, -0.99]$ gives $k = [-13.0002, -11.0001, -0.9999]$ which on rounding gives the solution given above.}

7.3 Problems

Problem 7.1

A feedback system has $G(s) = 32/s(s^2 + 4s + 16)$ and $H(s) = 1$. It is required to design a controller keeping the same velocity constant, that is 2, so that the system has a step response with an overshoot no greater than 5%.

$$[[G_c(s) = \frac{1 + 0.25s}{1 + 0.1s} \text{ (phase lead) in feedback path gives 5\% overshoot and settling time of 3.7s or } \\ G_c(s) = \frac{1 + 10s}{1 + 21.5s} \text{ (phase lag) in forward path gives 4\% overshoot and settling time of 14s.}]$$

Problem 7.2

A plant has a transfer function of $G(s) = 4\omega_o^2 / (s + 4)(s^2 + 2\zeta s\omega_o + \omega_o^2)$ with the parameters ζ and ω_o estimated as 0.1 and 1.0, respectively. It is therefore decided to design a controller with zeros to cancel the poles and since no steady state error is required for a step input the controller transfer function is taken as $G_c(s) = (s^2 + 0.2s + 1) / s(s + 1)$. Determine the gain and phase margins of the compensated system and obtain the closed loop step response giving the % overshoot and settling time. There is concern about the value of the plant parameters so the behaviour of the system is examined for (i) a 10% reduction in ζ and (ii) a 10% reduction in ω_o . Discuss your results.



**Technical training on
WHAT you need, WHEN you need it**

At IDC Technologies we can tailor our technical and engineering training workshops to suit your needs. We have extensive experience in training technical and engineering staff and have trained people in organisations such as General Motors, Shell, Siemens, BHP and Honeywell to name a few.

Our onsite training is cost effective, convenient and completely customisable to the technical and engineering areas you want covered. Our workshops are all comprehensive hands-on learning experiences with ample time given to practical sessions and demonstrations. We communicate well to ensure that workshop content and timing match the knowledge, skills, and abilities of the participants.

We run onsite training all year round and hold the workshops on your premises or a venue of your choice for your convenience.

For a no obligation proposal, contact us today at training@idc-online.com or visit our website for more information: www.idc-online.com/onsite/

OIL & GAS ENGINEERING

ELECTRONICS

AUTOMATION & PROCESS CONTROL

MECHANICAL ENGINEERING

INDUSTRIAL DATA COMMS

ELECTRICAL POWER

Phone: +61 8 9321 1702
Email: training@idc-online.com
Website: www.idc-online.com

IDC TECHNOLOGIES

[Gain and phase margins 14dB at 2.0 rads/s and 41.2° at 0.776 rads/s. 28% overshoot at 3.81s and a settling time of 11.4s. (i) Effect relatively small (ii) The closed loop system is unstable with gain and phase margins of -1.79dB at 0.872 rads/s and -13.7° at 0.907 rads/s]

Problem 7.3

A process has a transfer function of $G(s) = 2/(1+s)(1+0.5s)(1+0.1s)$ which is to be controlled in a feedback loop with $H(s) = 1$ and a PID controller with transfer function $G_c(s) = K\{1 + (1/sT_i) + (sT_d/1 + \alpha sT_d)\}$, with $\alpha = 0.1$ What are the critical gain, K_c , and frequency, ω_c , of the plant? It is required to achieve a set point step response with an overshoot of no more than 16% and a settling time of 2 seconds. What are the results from the following two design approaches?

- Use of the Ziegler - Nichols tuning parameters, $K = 0.6K_c$, $T_i = 0.5T_c$ and $T_d = 0.125T_c$, where $T_c = 2\pi / \omega_c$.
- The critical frequency is moved to the point $0.6/_-125^\circ$ on the compensated Nyquist locus. Give the calculated values of K and T_d to do this assuming $\alpha = 0$ and $T_i = 4T_d$.

[$K_c = 9.9$ and $\omega_c = 5.66$. (a) Gain and phase margins of 22.2dB at 20.4rads/s and 24.4° **at 4.54 rads/s**. Step response overshoot of 55% at 0.65s and a settling time of 3.6s. (b) Gain and phase margins of 20.3dB at 18.5rads/s and 57.2° **at 3.95 rads/s**. Step response with an overshoot of 13% at 0.69s and a settling time of 1.4s.- meets specifications.]

Problem 7.4

A plant has a transfer function $G(s) = 16/s(s+1)(s+4)$ and is to be controlled in a loop with unit negative feedback by the compensator $G_c(s) = (1+sT)/(1+s\alpha T)$, with $\alpha > 0.1$. The speed of the response to a step input is not critical but a major requirement is that the overshoot should not exceed 10%, determine suitable values for α and T .

[$G_c(s) = \frac{s+1}{0.1s+1}$ (lead) in feedback path, no overshoot and a settling time of 4.1s. $G_c(s) = \frac{34s+1}{340s+1}$

(lag) in forward path 11% overshoot at 7.6s and settling time of around 40s.]

Problem 7.5

A feedback system has a plant with a transfer function $G(s) = 4/s(1+0.4s)(1+0.1s)$ and $H(s) = 1$. Design phase lead and phase lag compensators to give the feedback loop a phase margin of around 45°. Obtain the closed loop step responses for the two designs with the compensator in the error channel and also for the phase lead design with the compensator in the feedback path.

[Lead $G_c(s) = \frac{0.45s+1}{0.15s+1}$, Step responses:- error channel 24% overshoot settling time 2.3s, feedback path no overshoot settling time 2.0s. Lag $G_c(s) = \frac{6.6s+1}{14.6s+1}$ gives step response overshoot 24% and settling time 6.7s]

Problem 7.6

A process with a transfer function of $G(s) = 2e^{-0.3s} / (1 + 0.4s)^2$ is to be controlled in a feedback loop with $H(s) = 1$ and a PI controller with transfer function $G_c(s) = K \{1 + (1/sT_i)\}$. What are the critical gain, K_c , and frequency, ω_c , of the plant? What are the results from the following two design approaches for the closed loop step response?

- a) Use of the Ziegler – Nichols tuning parameters, $K = 0.45K_c$ and $T_i = 0.8T_c$, where

$$T_c = 2\pi / \omega_c .$$

- b) The PI controller should give a phase lag of 15° and the open loop gain of the compensated frequency response should be $0.7 / K_c$ at the critical frequency ω_c .

[$K_c = 1.68$ and $\omega_c = 3.84$. (a) $K = 0.74$ and $T_i = 1.31$, 19% overshoot at 1.4s and settling time 5.3s. (b) $K = 0.68$ and $T_i = 0.97$, 26% overshoot at 1.5s and settling time 5.3s.]

Problem 7.7

A feedback system has a plant with a transfer function $G(s) = 1/s(1+s)^2$. Show that in a feedback loop with unit negative feedback gain it will have a phase margin of 21.4° at the frequency 0.682rad/s. Design a phase lag controller with unit gain at zero frequency to give a phase margin for the system of around 45° and give details of the resultant closed loop step response.

[$G_c(s) = \frac{20s+1}{60s+1}$ gives a phase margin of 46.7° , step response overshoot of 24% at 7.5s and settling time 32s.]

Problem 7.8

A feedback system has a plant with a transfer function $G(s) = 1/s(1+0.5s)^2$. Show that in a feedback loop with unit negative feedback gain it will have a phase margin of 21.4° at the frequency 1.365rad/s. Design phase lag controllers with unit gain at zero frequency, by both frequency response and root locus methods, to achieve a closed loop system step response with an overshoot no greater than 10%.

[$G_c(s) = \frac{20s+1}{60s+1}$ gives 8% overshoot and settling time of 35s]

Problem 7.9

A relay autotuning experiment was performed on a process and the values obtained for the critical gain and critical frequency were 2.0 and 1.0 rads/s, respectively. It was decided to control the process with an ideal PID controller in the error channel and to select the controller parameters so that the integral time constant was four times the derivative time constant and the frequency of 1.0 rads/s occurred at a gain of 0.5 and a phase of -150° on the compensated Nyquist locus. What are the required values for the controller gain and derivative time constant.

$$[K = 0.866 \text{ and } T_d = 0.866]$$

Problem 7.10

A relay autotuning experiment was performed on a process and the values obtained for the critical gain and critical frequency were 1.8 and 1.0 rads/s, respectively. It was decided to control the process with an ideal PID controller in the error channel and to select the controller parameters so that the integral time constant was four times the derivative time constant and the frequency of 1.0 rads/s occurred at a gain of 0.55 and a phase of -150° on the compensated Nyquist locus. What are the required values for the controller gain and derivative time constant.

$$[K = 0.86 \text{ and } T_d = 0.866]$$

I joined MITAS because
I wanted **real responsibility**

The Graduate Programme
for Engineers and Geoscientists
www.discovermitas.com





Month 16
I was a construction
supervisor in
the North Sea
advising and
helping foremen
solve problems

Real work
International opportunities
Three work placements





Problem 7.11

A process with a transfer function of $G(s) = 2/(1+s)^3$ is to be controlled in a feedback loop with $H(s) = 1$ and a PI controller with transfer function $G_c(s) = K\{1 + (1/sT_i)\}$. What are the critical gain, K_c , and frequency, ω_c , of the plant? Determine the parameters of the PI controller if it is designed to:-

- Use the Ziegler – Nichols tuning parameters, $K = 0.45K_c$ and $T_i = 0.8T_c$, where $T_c = 2\pi / \omega_c$.
- To move the critical point to a gain of 0.4 and phase -192° on the compensated Nyquist locus.
- A zero of the compensator is used to cancel a pole of the process transfer function and the gain margin is adjusted to 12dB.

Compare the closed loop step responses of the three designs.

[$K_c = 4.0$ and $\omega_c = 1.732$. (i) $K = 1.80$ and $T_i = 2.90$. 57% overshoot, settling time 33s (ii) $K = 1.56$ and $T_i = 2.71$. 52% overshoot, settling time 27s (iii) $K = 0.25$ and $T_i = 1.0$. 25% overshoot, settling time 20s]

Problem 7.12

A feedback system has a plant with a transfer function $G(s) = 4/s(1+s)(1+0.1s)$ and $H(s) = 1$. Design a phase lead compensator using pole zero cancellation and with unit gain at zero frequency to give a phase margin of around 50° . Also design a phase lag compensator, again with unit gain at low frequency, to achieve the same phase margin. Obtain the closed loop step responses for the two designs with the compensator in the error channel and also for the phase lead design with the compensator in the feedback path.

[$G_c(s) = \frac{s+1}{0.1s+1}$ gives a phase margin of 50.9° . Step response in error channel 17% overshoot and 1.7s settling time and in feedback path no overshoot and settling time 4s. $G_c(s) = \frac{16s+1}{96s+1}$ gives a phase margin of 51.5° . Step response 20% overshoot and settling time 25s.]

Problem 7.13

Show that for an ideal PID controller, $G_c(s) = K\{1 + (1/sT_i) + sT_d\}$, placed in the error channel and controlling a plant with transfer function $G(s)$ that, if the design strategy is to place the critical frequency of the plant at a point $g \angle -135^\circ$ on the compensated frequency response locus, then the PID controller gain will be independent of the choice of the ratio T_i/T_d .

Problem 7.14

A system has a state space description $A = \begin{pmatrix} 53 & 45 & 30 \\ -1 & -1 & 0 \\ -103 & -87 & -59 \end{pmatrix}$, $B = \begin{pmatrix} -1 \\ 0 \\ 2 \end{pmatrix}$, $C = (8 \ 5 \ 4)$ and $D = 0$.

Determine the transfer function of the system. Find the eigenvalues of A and the transformation matrix T to put the system into the controllable canonical form, where $A_c = T^{-1}AT$. Use this value of T to obtain the controllable canonical form A_c, B_c, C_c, D_c and confirm that this agrees with the transfer function.

Determine the required feedback gains for the system A, B, C, D to have its poles at -2, -2.5 and -3 and the corresponding input-output transfer function. Why is the transfer function second order?

[Transfer function is $\frac{s+3}{s^3+7s^2+14s+8}$, Eigenvalues are -1, -2 and -4. $T = \begin{pmatrix} 1 & 0 & -1 \\ -1 & 1 & 0 \\ 0 & -1 & 2 \end{pmatrix}$ and transfer function is $\frac{1}{s^2+4.5s+5}$. Pole - zero cancellation.]

Problem 7.15

A system has a state space description $A = \begin{pmatrix} -2 & 0.5 & 0 \\ -2 & 1 & 4 \\ -2 & -1 & -1 \end{pmatrix}$, $B = \begin{pmatrix} 1 \\ 0 \\ 1 \end{pmatrix}$, $C = (1 \ -0.5 \ -1)$ and $D = 0$. Determine the transfer function of the system and the eigenvalues of A . Find the required feedback gains for the system

to have its poles at -1, -2 and -3 and the corresponding input-output transfer function.

[Transfer function is $\frac{1}{s^3+2s^2+2s+1}$, Eigenvalues are -1, and $-0.5 \pm 0.66j$. Gain vector (14, -0.5, -10) and transfer function is $\frac{1}{s^3+6s^2+11s+6}$.]

Problem 7.16

Design the controller for Problem 7.2 by first modifying the plant transfer function with state variable feedback so that its poles are at -1, -2 and -3. Then close the loop so that the error, the difference between the input R and plant output, is fed through the transfer function $(s+1)/s$ to the modified plant input. What is the required feedback gain vector? Compare the closed loop step responses with those of problem P7.2 and show that they are less sensitive to plant parameter variations than the design of problem P 7.2.

[Gain vector is (0.5, 2.3, 0.45)]

8 Phase Plane Analysis

8.1 Introduction

Phase plane analysis is a method which can be useful in the study of second order nonlinear systems and is covered in chapter 2 of reference 2. A second order system has two states and its motion can be shown by plotting one state against the other with time a parameter on the locus, known as a trajectory. When the second state is the derivative of the first state, typically the output, the state variables are known as phase variables, and the trajectory motion is in a phase plane. The method was originally used by physicists but was found particularly useful in the early days of control engineering because of the ease with which it could be applied to nonlinear second order systems, typically position control systems or servomechanisms as they were often called, where the nonlinearities were described by linear segmented characteristics. It has the advantage that it can be applied when the feedback loop contains more than one nonlinear element. Several phase plane examples, relating to the determination of oscillations or step responses, are given in this section.

8.2 Examples

Example 8.1

Figure 8.1 shows the block diagram of a second order system where NL_1 is an on off relay with hysteresis having switching levels $\Delta = \pm 1$ and output levels $h = \pm 1$ and NL_2 is bx^3 . Derive the equations which can be used to determine the limit cycle in the system with $R = 0$ and find its phase plane coordinates at the switching times and its frequency if $a = K = 1$ and $b = 0.5$. Compare the solution with simulation results.

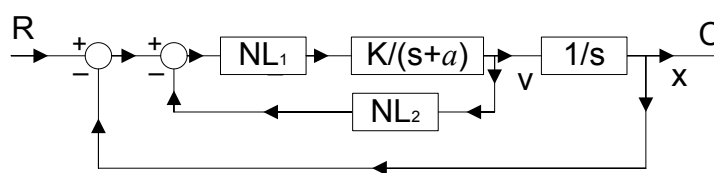

Figure 8.1 Block diagram for Example 8.1

The transfer function $K/s(s+a)$ has inputs from NL₁ of ± 1 . Denote its output as x and its derivative (the input to NL₂) as v . The input to NL₁ will be $-x - bv^3$ and assuming this is positive and greater than 1 it will produce a positive output from NL₁ until $-x - bv^3 = -1$, that is until the curve $x + bv^3 = 1$ in the phase plane is reached by the trajectory. The differential equation for x when the output from NL₁ is $+1$ is $\ddot{x} + a\dot{x} = K$ which to obtain the solution can be written in Laplace transform form as $s^2X(s) - sx(0) - \dot{x}(0) + a\{sX(s) - x(0)\} = K/s$, which can be written as $X(s) = \frac{K}{s^2(s+a)} + \frac{v(0)}{s(s+a)} + \frac{x(0)}{s}$ and on inverting gives the solution $x(t) = \frac{Kt}{a} - \frac{K}{a^2} + \frac{Ke^{-at}}{a^2} + \frac{v(0)}{a} - \frac{v(0)e^{-at}}{a} + x(0)$ and by differentiation the expression for its derivative is $v(t) = \frac{K}{a} - \frac{Ke^{-at}}{a} + v(0)e^{-at}$. The equation for a phase plane trajectory for an output of $+1$ from NL₁ can be obtained by eliminating t from these equations and is $x(t) = x(0) - \frac{v(t) - v(0)}{a} + \frac{K}{a^2} \log_e \left\{ \frac{av(0) - K}{av(t) - K} \right\}$. This is not a simple curve and the limit cycle can be found as easily using the equations for $v(t)$ and $x(t)$, since the limit cycle will be symmetrical with two trajectory arcs one for the output of NL₁ equal to $+1$, described by the above equations, and the other for the output of NL₁ equal to -1 . Thus if we assume that for NL₁ equal to $+1$ the trajectory starts after switching at the point $(-x_1, -v_1)$ in the phase plane it will finish, by symmetry, at the point (x_1, v_1) , where the output of NL₁ switches to -1 . {Note this concept can be used to obtain limit cycles in relay systems for higher order systems and is inherent in the time domain method of Hamel and the state space formulation of Chung (reference 8.1) used more recently in reference 8.2}. Thus putting these initial and final conditions into the above equations gives $x_1 = \frac{Kt}{a} - \frac{K}{a^2} + \frac{Ke^{-at}}{a^2} - \frac{v_1}{a} + \frac{v_1e^{-at}}{a} - x_1$ and $v_1 = \frac{K}{a} - \frac{Ke^{-at}}{a} - v_1e^{-at}$. Further the point (x_1, v_1) lies on the curve $x + bv^3 = 1$ so that $x_1 + bv_1^3 = 1$. These three equations allow solutions to be obtained for the three unknowns x_1 , v_1 and t , when a , b and K are given.

Thus for $a = K = 1$ and $b = 0.5$ the three equations are:-

$$2x_1 = t - 1 + e^{-t} - v_1 + v_1e^{-t}; \quad v_1 = 1 - e^{-t} - v_1e^{-t}; \quad \text{and} \quad x_1 + 0.5v_1^3 = 1.$$

Solving these using `fminsearch` in Matlab gives $x_1 = 0.622$, $v_1 = 0.911$ and $t = 3.066$. The period of the limit cycle is thus 6.13 seconds which corresponds to a fundamental frequency of 1.03 rads/s. The solution in simulink for an initial condition on the output, C , of +1 is shown in figure 8.2, which confirms the values calculated for x_1 and v_1 , and additional measurements confirm the period.

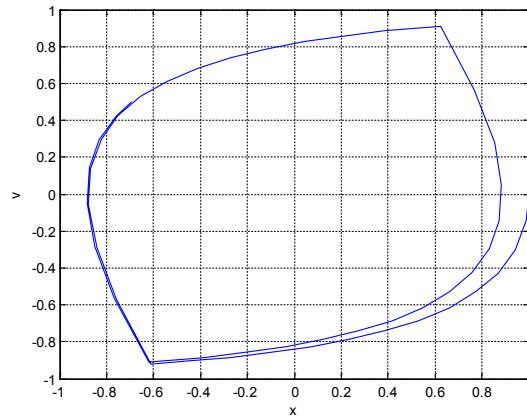

Figure 8.2 Simulink solution for the limit cycle.

Example 8.2

Consider the system shown in the block diagram of figure 8.3 in which the nonlinearity NL_1 is a relay with dead zone with output values of ± 1 and switching levels of ± 1 . Find the required value of b in terms of K and a for the step response not to have an overshoot.

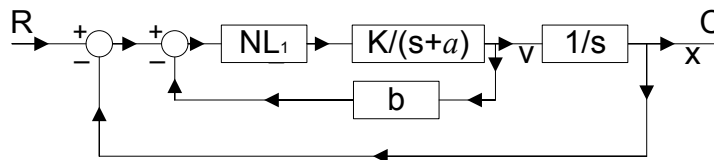

Figure 8.3 Block diagram for example 8.2

Again denoting the output by x and its derivative by v , then for a large step input the maximum value of v is K/a , which is typically studied in the phase plane by assuming a large negative initial value for x . The output of NL_1 switches to zero when $-x - bv = 1$ so that the response is then described by the above equations in example 8.1 with $K = 0$. From these it is easy to see that $ax(t) = v_1 - v(t) + ax_1$ which describes a straight line of slope $-a$ in the phase plane. Thus for this final motion with no relay output to reach the origin the initial conditions must satisfy $v_1 = -ax_1$. For a large step input $v_1 = K/a$ and since the initial value points lie on the switching line $-x_1 - bv_1 = 1$ elimination of x_1 and v_1 between these equations gives $K(1 - ab) = a^2$ which can be written as $b = (K - a^2) / Ka$. For a finite value of b then $K > a^2$.

Thus if there is no feedback b , that is $b = 0$, there will be no overshoot for a large step input provided $K < a^2$ and the response for a negative initial condition $-x_0$ on the output C will come to rest with the output between -1 and zero, reaching zero for a large value of x_0 if $K = a^2$. For $K > a^2$ there will be an overshoot for large x_0 until $K = 2a^2$ when the overshoot will be 1 and a further switch of the relay will take place for $K > 2a^2$.

Introducing a finite b will prohibit overshoots for large values of x_0 for larger values of K . For example, to avoid overshoots for large values of x_0 for $a = 1$ and $K = 10$ requires $b = 0.9$ and for $a = 2$ and $K = 10$ requires $b = 0.3$.

Example 8.3

A second order conservative nonlinear system is described by the differential equation $\ddot{x} + n(x) = 0$ where $n(x)$ is a nonlinearity. Obtain a solution for the period of the undamped oscillation in terms of the initial value for x of $-x_0$. Calculate the value of this period for $x_0 = -1$ and $x_0 = -1.5$ for the nonlinearities (i) $n(x) = x$, (ii) $n(x) = x^3$ and (iii) $n(x) = \sin x$.

Denoting the derivative of x by v the phase plane differential relationship is $v dv / dx = -n(x)$, which assuming initial values of $-x_0$ and v_0 gives $v^2 - v_0^2 = -2 \int_{-x_0}^x n(x) dx$, which can be written as $v^2 - v_0^2 = 2\{F(-x_0) - F(x)\}$ where $F(x) = \int_0^x n(x) dx$. Writing $v = dx / dt$ gives $\frac{dx}{dt} = [v_0^2 + 2\{F(-x_0) - F(x)\}]^{1/2}$ which can be integrated wrt x from $-x_0$ to 0 with $v_0 = 0$ to give a quarter cycle of the oscillation. Thus the period $T = 4 \int_{-x_0}^0 \frac{dx}{[2\{F(-x_0) - F(x)\}]^{1/2}}$.

a) For $n(x) = x$ the linear case one has $F(x) = \int_0^x n(x) dx = \int_0^x x dx = x^2 / 2$, so that

$$T = 4 \int_{-x_0}^0 \frac{dx}{[2\{(x_0^2 / 2) - (x^2 / 2)\}]^{1/2}}, \text{ which since the integrand has even symmetry can be}$$

written $T = 4 \int_0^{x_0} \frac{dx}{(x_0^2 - x^2)^{1/2}}$. This gives the well known result that

$$T = 4 \sin^{-1}(x / x_0) \Big|_0^{x_0} = 4 * (\pi / 2) = 2\pi, \text{ which is independent of the initial condition.}$$

b) For $n(x) = x^3$ one has $F(x) = \int_0^x n(x)dx = \int_0^x x^3 dx = x^4 / 4$, so that

$T = 4 \int_0^{x_0} \frac{dx}{[(x_0^4/2) - (x^4/2)]^{1/2}}$, for which no analytical solution is known. The integral depends on the initial condition $-x_0$ and can be found numerically in Matlab using the

numerical integration routine 'quad'. For initial conditions of 1 and 2 the values of T are 7.42 and 3.61, respectively. They can also be checked by simulation. Figure 8.4 shows the Simulink phase plane plots for several different values of x_0 .

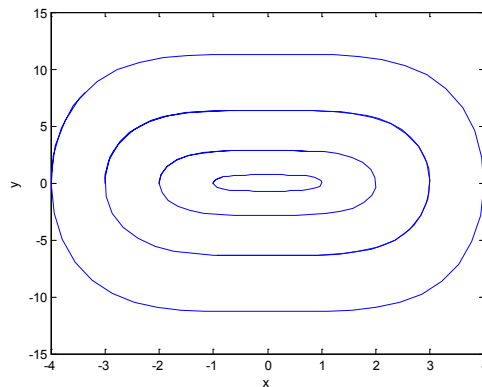

Figure 8.4 Phase plane plots for cubic nonlinearity

www.job.oticon.dk

oticon
PEOPLE FIRST

- c) For $n(x) = \sin x$ one has, $F(x) = \int_0^x n(x)dx = \int_0^x \sin x dx = -\cos x$ so that
- $$T = 4 \int_0^{x_0} \frac{dx}{[2(\cos x - \cos x_0)]^{1/2}},$$
- for which again no analytical solution is known. The integral again also depends on the initial condition $-x_0$ and can be found numerically in Matlab using the numerical integration routine 'quad'. In this case since $\sin x = 0$ for, $x = n\pi$ there are multiple singular points and those for $x = \pm\pi$ are saddle points, so that oscillations around the origin do not exist for $|x_0| > \pi$. The period of the oscillations increases as x_0 increases and is 6.38, 6.70, 8.35 and 16.16, respectively for $-x_0$ equal to 0.5, 1.0, 2.0 and 3.0. Figure 8.5 shows the Simulink phase plane plots for these values of x_0 , obtained using default values in the Simulink simulation. Thus the trajectories are not very smooth but illustrate the change in shape for the different initial conditions.

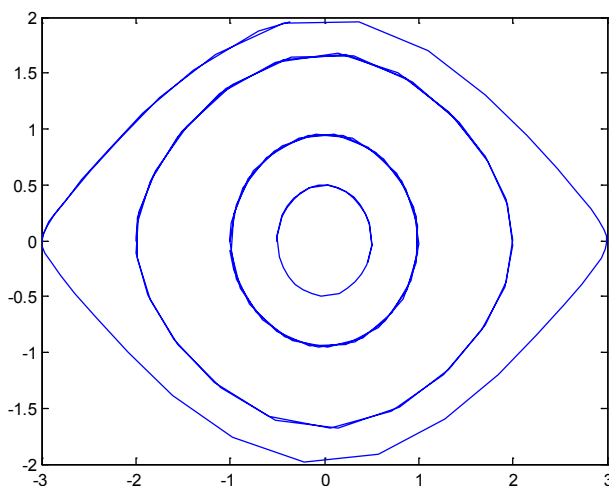

Figure 8.5 Phase plane plots for conservative system with sinusoidal nonlinearity

Example 8.4.

Figure 8.6 shows the block diagram of a position control system with unit Coulomb friction where the nonlinearity is a signum function, that is equals +1 for positive velocity and -1 for negative velocity. Determine the response for an input step of 10 and compare with the result if there is no Coulomb friction.

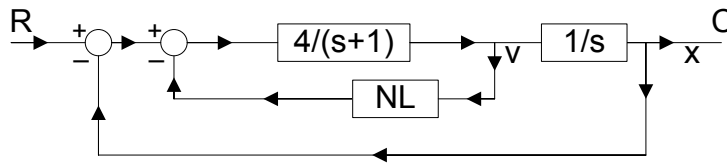

Figure 8.6 Block diagram for a system with Coulomb friction

The Coulomb friction has the effect of making the singular point +1 for positive values of v and -1 for negative values of v . Thus the effective magnitude of the step input is 9 and since the closed loop transfer function excluding the Coulomb friction is $4/(s^2 + s + 4)$, which has a damping ratio of $\zeta = 0.25$, the overshoot is $9 \exp(-0.25\pi/(1 - 0.25^2)^{0.5}) = 9(0.444) = 3.996$ so that the next motion with a negative velocity will be from -2.996 about -1. The overshoot will be $1.996 \times 0.444 = 0.88$, so that the motion comes to rest at -0.12. The successive overshoots for the step input of 10 with no Coulomb friction damping are $10 * (0.444)^n$ for $n = 1, 2, 3 \text{ etc}$. Thus the zero velocity axis is crossed at -4.44, 1.971, -0.875, etc. The responses without and with Coulomb friction are shown as plots (i) and (ii) in Figure 8.7

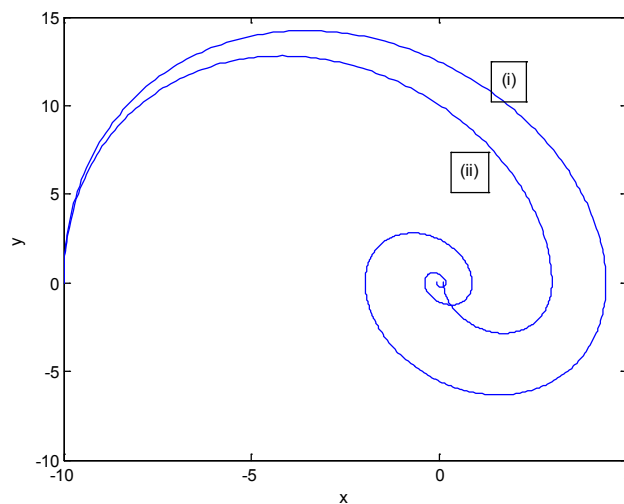

Figure 8.7 Responses of the system of Figure 8.6 to a step input of 10

Example 8.5

Figure 8.8 shows a position control system where NL_1 is a saturation characteristic with a very high gain in the linear regime and output levels of ± 2 and NL_2 is Coulomb friction with levels of ± 0.5 . If $K = 8$ calculate the required value of b to give a fast response and ensure no overshoot for step inputs of magnitude less than 4 units for the system without and with Coulomb friction.

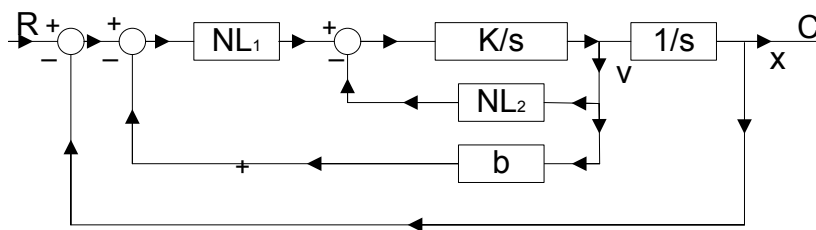

Figure 8.8 Block diagram for Example 8.5

The response will be faster without Coulomb friction so this case needs to be considered to determine b . With the linear regime of NL_1 very small, switching from positive to negative torque will occur at the line $-x - bv = 0$ and the motion will be described by parabolas in the phase plane. For a response with no overshoot switching from the positive torque parabola to the negative one should take place half way to the origin, that is at $x = -2$. The parabola through the origin has the equation $v^2 - v^2(0) = -4K\{x - x(0)\}$, where $v = x = 0$, and $x(0), v(0)$ will lie on the switching line so that $-x(0) - bv(0) = 0$. Thus substituting $K = 8$ and $x(0) = -2$ gives $2^2 / b^2 = 32 * 2$, so that $b = 0.25$. The point on the switching line where switching takes place is thus $(-2, 8)$ and the switching line has a slope of -4 . When the Coulomb friction is included, which is chosen relatively larger than would be expected in practice to clearly show its effect, the maximum value of the input to K/s will be reduced from 2 to 1.5, so the initial part of the response will be given by the parabola $v^2 - v^2(0) = 3K\{x - x(0)\}$, with $x(0) = -4$ and $v(0) = 0$. This will meet the switching line $-x - 0.25v = 0$ at the point $(-1.81, 7.25)$. Starting from this point denoted $x(0), v(0)$ the ensuing parabola, because the Coulomb friction assists the deceleration, is $v^2 - v^2(0) = -5K\{x - x(0)\}$. It will meet the switching line again before the origin and the ensuing motion will be a sliding motion down the switching line. Figure 8.9 shows the responses obtained in Simulink for step inputs of 6, 4 and 2 respectively, with those labelled with a * being the ones with the Coulomb friction included. Note that with no Coulomb friction the response for a step of 6 shows an overshoot, as expected, and then the final motion is along the switching line, and for a step of 2 the response soon returns to the switching line after the first switching and then slides down it to the origin. The responses are of course slower with the Coulomb friction included, as will be seen if the time responses are plotted, but is apparent from the phase plane because of the lower velocity profiles.

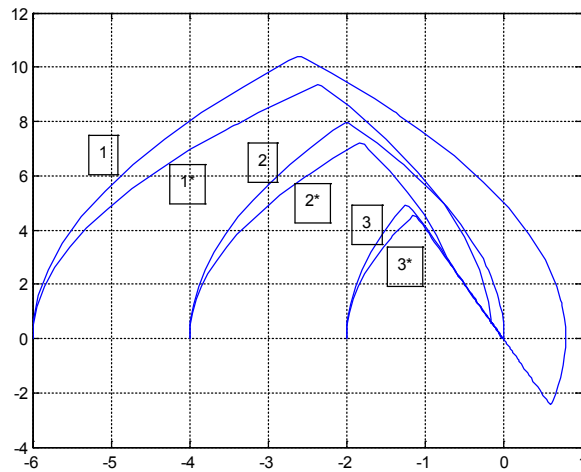

Figure 8.9 Simulink responses for Example 8.5

Example 8.6

It is sometimes appropriate to limit the velocity in a position control system and this can be done by limiting the magnitude of the error signal as illustrated in Figure 8.10, where NL₃, a saturation characteristic, has been added to the block diagram of Figure 8.8. Design the saturation characteristic so that the response will not exceed a velocity of 8 units and thus have no overshoot for a step input of any magnitude.

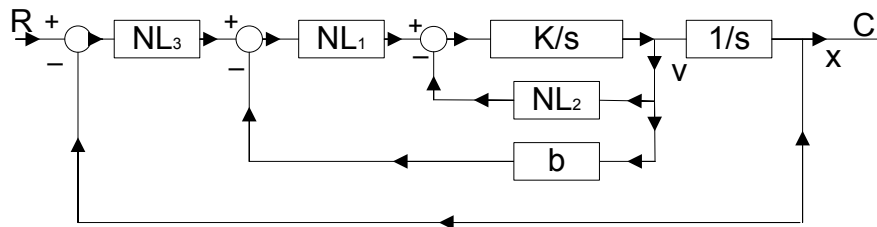

Figure 8.10 Modification of Figure 8.8 by the addition of saturation.

The response with no overshoot in the previous example for no Coulomb friction has a maximum velocity of 8 units reached when $x = -2$. The switching line with error limiting will be $n_3(-x) - 0.25v = 0$ and for this to be $v = 8$ requires $n_3(-x) = 2$, so that the required saturation level is 2. Thus, when $v = \pm 8$ in any response sliding will take place.

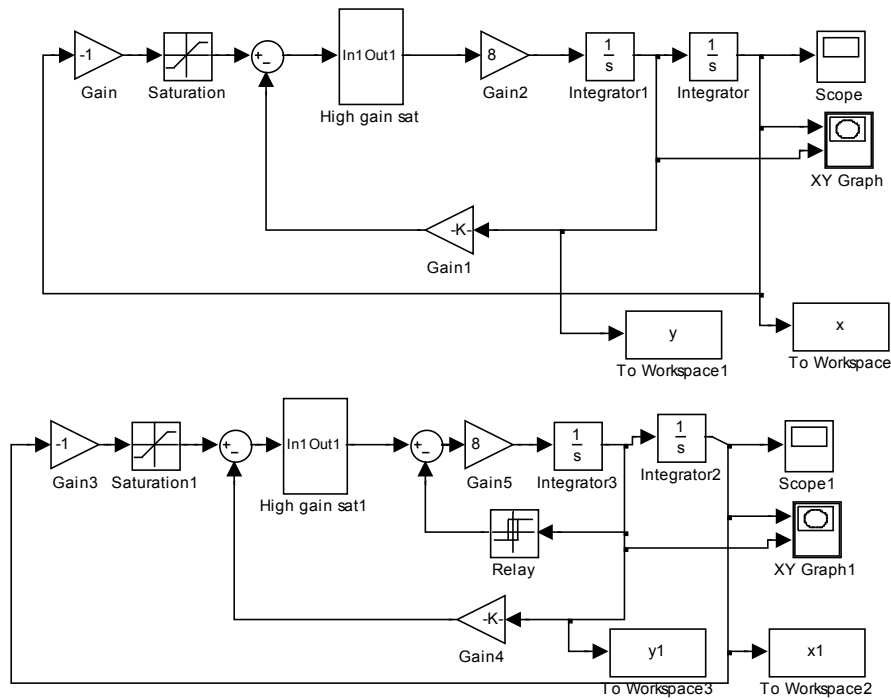

Figure 8.11 Simulink diagram for Example 8.6

Schlumberger

WHY WAIT FOR PROGRESS?

DARE TO DISCOVER

Discovery means many different things at Schlumberger. But it's the spirit that unites every single one of us. It doesn't matter whether they join our business, engineering or technology teams, our trainees push boundaries, break new ground and deliver the exceptional. If that excites you, then we want to hear from you.

careers.slb.com/recentgraduates



The simulink diagram for the example is shown in Figure 8.11, where the systems without and with Coulomb friction are simulated in parallel. This is a useful technique when one wishes to compare the performance of two systems. Also, some oscilloscopes additional to those shown in the diagram were used. Figure 8.12 shows the responses obtained on the phase plane for step inputs of -4, -6 and -10, respectively. Those marked with an asterisk are again for the case of Coulomb friction included. If the step is large enough for the maximum velocity to be reached then the final part of the response will be the parabolic curve straight to the origin when there is no Coulomb friction. With Coulomb friction, however, the response will be initially along a parabola followed by some sliding down the switching line.

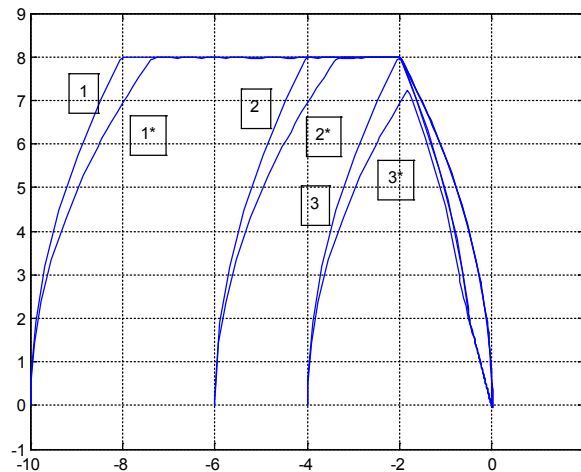

Figure 8.12 Phase plane responses for Example 8.6

Example 8.7

Figure 8.13 shows the system of the previous example but with the first integrator of transfer function K/s replaced by the transfer function $K/(s+a)$. Discuss how the phase plane trajectories in Figure 8.12 for $K = 8$ will change for finite values of a and obtain the responses for $a = 0.5$.

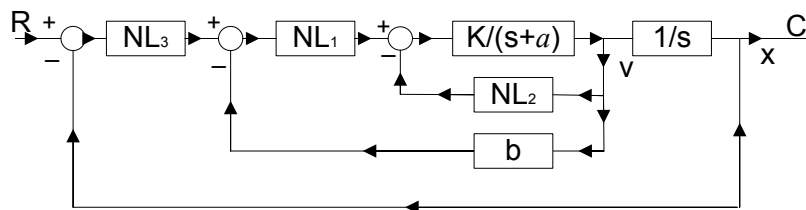

Figure 8.13 Block diagram for Example 8.7

The effect of a , which is equivalent to viscous friction, is to change the phase plane plots from parabolas. For positive velocity when the torque is positive the velocity increase in the phase plane trajectory is slower than that of the parabola and when the torque is negative the velocity decrease in the phase plane trajectory is faster than that of the parabola. Thus as a increases the time taken to reach the velocity limit will increase and after switching the retardation will be faster. Figure 8.14 shows the simulations for $a = 0.5$, where these aspects can be clearly seen when compared with Figure 8.12. In particular it can be seen that the final path of the trajectories for large inputs, including the case for no Coulomb friction, end up sliding down the switching line to the origin. It is, of course, possible to avoid the sliding by suitable adjustment of the saturation to a lower limit level, dependent on whether Coulomb friction is or is not present.

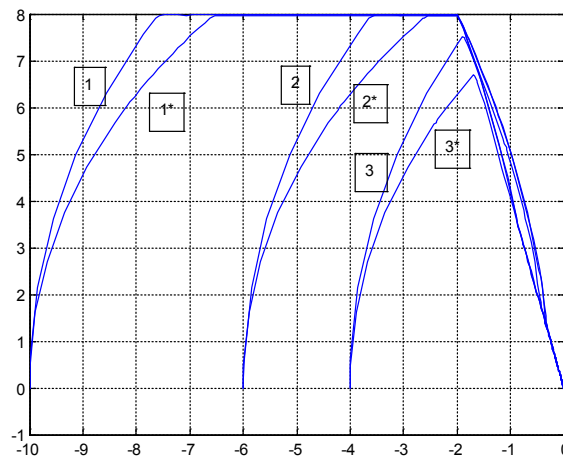

Figure 8.14 Phase plane trajectories for Example 8.7



PREPARE FOR A LEADING ROLE.

English-taught MSc programmes in engineering: Aeronautical, Biomedical, Electronics, Mechanical, Communication systems and Transport systems. No tuition fees.

→ liu.se/master

li.u LINKÖPING UNIVERSITY

Example 8.8

[**Note**;- It would probably be inappropriate not to include an example on backlash since the effect on performance caused by backlash in gears was one of the ‘driving forces’ for looking at the effects of nonlinearity in the early years of control engineering – then often known as servomechanisms. The model most often used for backlash is the nonlinearity shown in the Simulink diagram of Figure 8.15 and it is a relatively crude approximation of the actual physical phenomenon of backlash in gears. First it assumes that the friction to inertia ratio for the driven shaft is high so that when the drive shaft starts to slow down the driven shaft will remain in contact with the same gear teeth. Secondly, when the drive shaft reverses the same dynamics is used for motion through the backlash, whereas in fact the friction and inertia of the load should be excluded. Finally, when the drive shaft has moved across the backlash the teeth coalesce passively with the two shafts then continuing to move with the velocity achieved by the drive shaft. This motion across the backlash corresponds to the horizontal lines in the backlash characteristic in Figure 8.15. In practice the approximation by this model of the actual behaviour is not good as when the drive shaft slows down multiple impacts (i.e. oscillations between gear teeth in contact) may occur and on the reversal of direction the same phenomenon may occur with multiple impacts by the drive shaft in ‘picking up’ the driven shaft and the loss of energy in the impacts resulting in a velocity reduction. In fact the ‘pick up’ assumptions involve contradictory requirements as to ensure the drive shaft does not loose velocity requires it to have a high inertia relative to the driven shaft but if this is the case the impact will knock the driven shaft forward causing bouncing across the backlash and multiple impacts will occur. The only way to get better solutions for the problem of backlash is by simulating the impact phenomenon more accurately as some simulation languages allow.]

Thus after this ‘health warning’ the simple example portrayed by the Simulink diagram of Figure 8.15 is considered. Here the forward loop transfer function is of the form $K / s(s + a)$ and the backlash width $b = 1$. The requirements are (i) to simulate the system for the parameters $K = 16$ and $a = 1$ for a step input of -6 (ii) give the equations which describe the phase plane motion and (iii) repeat the simulation for $K = 2$ to show that there is then no limit cycle.

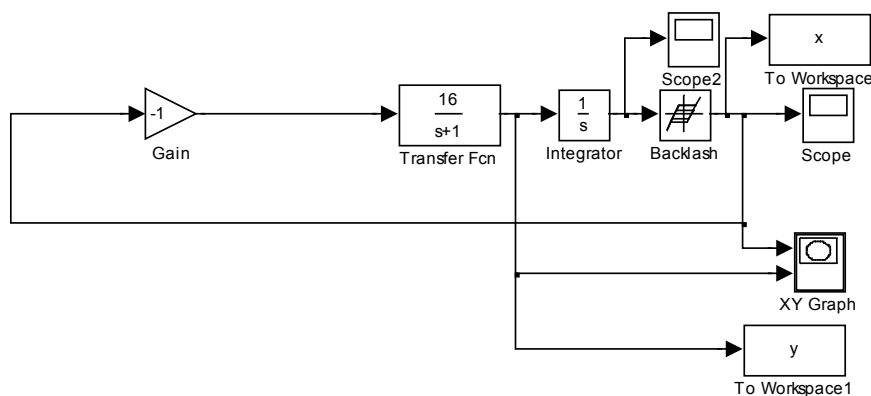

Figure 8.15 Simulink diagram for system with backlash.

Figure 8.16 shows the phase plane plot which is the velocity of the drive shaft versus the position of the output (driven) shaft. The initial output of the backlash is set at -6, the same as the initial value on the integrator, which in Simulink means that the drive shaft starts in the middle of the backlash. The first part of the motion is across the backlash so that the output shaft is stationary at -6 until the drive shaft has moved 0.5 ($b/2$) units. The motion for the drive shaft is therefore described by a constant input of 6 into the transfer function $K / s(s + a)$ with zero initial conditions. Thus from the equations in Example 8.1, with the parameters for K and a substituted, the expressions for position and velocity are $x(t) = 96(t - 1 + e^{-t})$ and $v(t) = 96(1 - e^{-t})$, respectively. The time to reach the end of the backlash is given by the solution of the first equation with $x(t) = 0.5$ and the velocity achieved at the end of the backlash is given from the second equation with the value of time substituted. The solutions are $t = 0.104$ and $v(t) = 9.47$, which are confirmed by time responses in the simulation. Motion with the two shafts in contact is given by the state equations $\dot{x} = v$ and $\dot{v} = -16x + v$ which can be written as $\frac{dv}{dx} = \frac{-16x + v}{v}$,

the slope of a trajectory in the phase plane. This gives the response from $(-6, 9.47)$ to $(x(1), 0)$, the point marked A in Figure 8.16 where the shafts both come to rest again. The next motion is again through the backlash to B where a slightly lower velocity is reached, although the distance travelled is now 1 unit, because the input to the motion is the value of x at A. In this case the motion is eventually seen to result in a limit cycle because the damping is quite small.

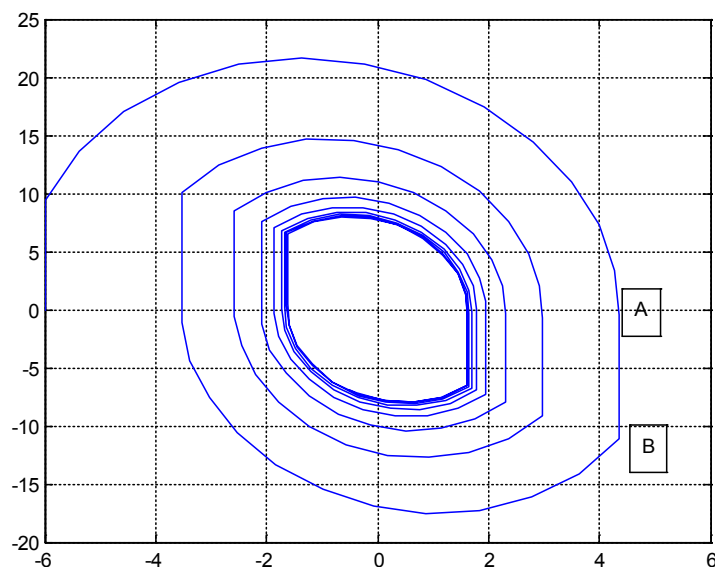

Figure 8.16 Phase plane plot for Example 8.8 with $K = 16$.

It is easy to repeat the simulation for different parameters and when $K = 2$ it will be found that the response is far less oscillatory and no limit cycle results.

References.

8.1 Chung J.K-C. and Atherton D.P., The Determination of Periodic Modes in Relay Systems Using the State Space Approach, International Journal of Control, Vol 4, pp. 105–126, 1966.

8.2 Majhi S. and Atherton D.P., On-line Tuning of Controllers for an unstable FOPDT Process, IEE Proceedings Control Theory and Applications, Vol. 147, pp. 421–427, 2000.

8.3 Problems**Problem 8.1**

Check by simulation the results derived in example 8.2 for the required value of b for no overshoot to large step inputs with (i) $a = 1$ and $K = 10$, (ii) $a = 2$ and $K = 10$ and (iii) $a = 2$ and $K = 20$.

[$b = 0.9; b = 0.3; b = 0.4$]

Problem 8.2

Calculate the point at which the final sliding motion to the origin for a step input of 4 starts in example 8.5 when the Coulomb friction is present.

[-0.69, 2.75]

Problem 8.3

Calculate the point at which the final sliding motion to the origin for large step inputs starts in example 8.6 when the Coulomb friction is present.

[-0.50, 2.00]

Problem 8.4

Calculate the value of b and saturation level required in example 8.6 if the requirement is that with Coulomb friction present the velocity for large step inputs should not exceed 8 and the final response should be parabolic straight to the origin.

[$b = 0.2; 1.6$]

Problem 8.5

If it is required in Example 8.7 for the response from the limit velocity of 8 to reach the origin without sliding find the required saturation limit level and gain b for (i) no Coulomb friction and (ii) Coulomb friction.

[1.72,0.215;1.41,0.176]

Problem 8.6

Check the results for problems 8.2 to 8.5 by simulation.

Problem 8.7

Sketch phase plane responses for step inputs to the system of Figure P8.7 when NL is an ideal relay with output levels $\pm h$, $K = \omega_o^2$ and $b = 2 / \omega_o$. {Note the last two parameters are such that if NL is linear of unit slope then the system will be critically damped}. Find the maximum step input for which the system will have no overshoot and the percentage overshoot for a step input of twice this value.

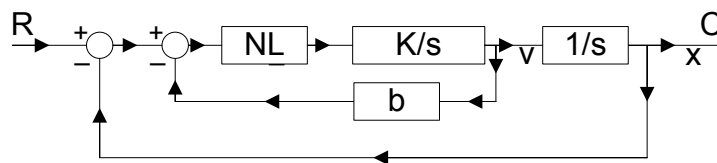

Figure P8.7

[16h, 22%]



Click on the ad to read more

Problem 8.8

If in Figure P8.7 NL is an ideal saturation characteristic with unit slope in the linear regime and saturation levels of $\pm h$, show that the maximum step input for no overshoot with the same parameters for K and b as Problem 8.7 is approximately $12.5h$.

Problem 8.9

Figure P8.9 shows an additional nonlinear characteristic, NL_1 , to that of Figure P8.7 and the other values are identical to those of Problem P8.7. Determine what the characteristic NL_1 with input u should be if the system should have no overshoot for all step inputs with $K = 4$ and $h = 2$. Check your result by simulation and show that there will also be no overshoot if the relay is replaced by the saturation characteristic as in Problem 8.8

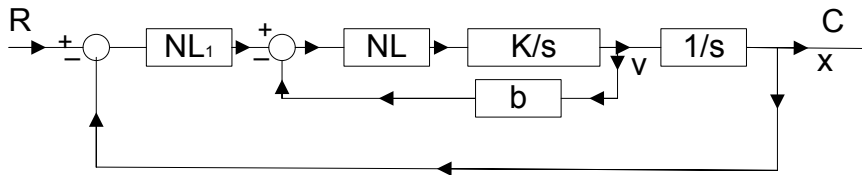

Figure P8.9

$$[4 \operatorname{sgn}(u) \sqrt{|u|}]$$

Problem 8.10

The block diagram below shows a feedback loop with Coulomb friction when the nonlinearity NL for input u is defined by $d \operatorname{sign}(u)$. If $d = 1$ find the magnitude of the first overshoot for a step input of 10 units if c has values of (i) 0.6 and (ii) 1.2. Check your results by simulation.

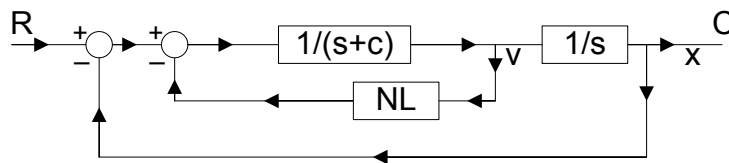

Figure P8.10

$$[2.35; 0.47]$$

Problem 8.11

In the block diagram of Figure P8.11 the nonlinearities NL_1 and NL_2 are respectively an on off relay with dead zone switching at ± 1 with output levels of ± 2 and an ideal saturation characteristic with unit slope saturating at ± 2 . Calculate the first overshoot and final steady state value for initial conditions on the output integrator of (i) -10 and (ii) -6 units. Check your results by simulation.

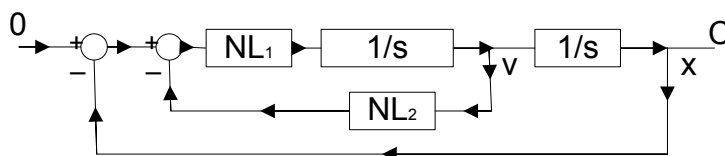

Figure P8.11

[6, 1; 2,-1]

Problem 8.12

In the block diagram of Figure P8.11 the nonlinearities NL_1 and NL_2 are respectively an on off relay with dead zone switching at ± 1 with output levels of ± 2 and $-u + (u^3 / b^2)$. Show that a limit cycle without sliding will only occur if $b \geq 4$. For this situation with no sliding show that the limit cycle will have a magnitude of $x = 1 + (b^2 / 4)$ and of $v = b$ and a period of $(2b^2 + 4) / b$. Check this out in simulation for values of $b=4$ and 6 and for $b=2$ show that sliding takes place in the limit cycle.

Problem 8.13

In the block diagram of Figure P8.13 the nonlinearity NL is an on off relay with dead zone and hysteresis with switching levels at ± 0.5 and ± 1.5 and output levels of ± 4 and 0. Determine the limit cycle in the system and show that it has a period of 7 seconds. Check your result by simulation.

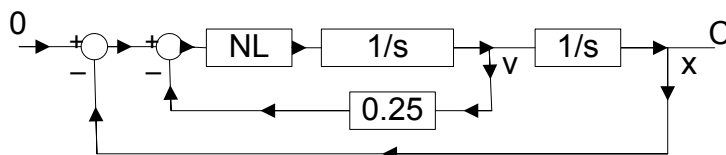

Figure P8.13

[Amplitude of $x = 2.5$, Amplitude of $v = 2$]

9 The Describing Function and Exact Relay Methods

9.1 Introduction

The DF method, which is covered in detail in chapters 3 to 5 in reference 2, enables certain aspects of a nonlinear feedback system to be investigated by representing a nonlinear element by a complex gain which is the ratio of the fundamental of its output to the amplitude, and possibly frequency, of a sinusoidal input. It can be extended to cover more than one sinusoidal input, including a sinusoid plus bias, two sinusoids and even random inputs. The examples begin with calculations of DFs for two static nonlinear elements and one for a rather complicated nonlinear configuration. The following ten examples then use the DF method to assess the stability and/or the calculation of limit cycles in feedback loops, including one for an asymmetrical limit cycle and another where two nonlinear elements exist in the loop. Results of some simulation studies are also given to enable the accuracy of the approximate solutions of the DF method to be seen. Finally a few examples are given on the calculation of the exact limit cycle frequency for feedback loops containing relay elements. The Tsytkin method for this analysis is described in detail in reference 2 but some calculations are also done using a state space approach not given in detail in reference 2. An advantage of the Tsytkin method for evaluating limit cycles in relay systems is the easy comparison it allows with the DF method and that the series solutions for the different transfer functions can be stored in computer files. With the facilities of Matlab, however, for solving nonlinear equations the state space approach originally introduced in reference 9.1 has some advantages as will be seen from the examples.

9.2 Examples

Example 9.1

Determine the DF of the symmetrical odd single valued nonlinear characteristic defined for positive values of x by

$$n(x) = 0 \text{ for } x < \delta_1$$

$$n(x) = m(x - \delta_1) \text{ for } \delta_1 < x < \delta_2$$

$$n(x) = m(\delta_2 - \delta_1) \text{ for } x > \delta_2$$

The characteristic $n(x)$ is shown in Figure 9.1 from which it can be seen that it is equivalent to the sum of two saturation characteristics labelled $n_1(x)$ and $-n_2(x)$, respectively.

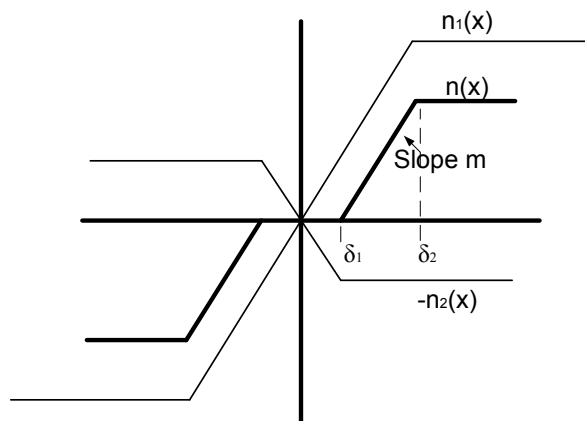

Figure 9.1 Nonlinearity and its synthesis from two ideal saturation characteristics.

The DF for an ideal saturation with linear slope m and saturating at an input δ is $mN_s(\delta/a)$ where

$$N_s(\delta/a) = \begin{cases} 1 & \text{for } a < \delta \\ (1/\pi)[2\alpha + \sin 2\alpha] & \text{for } a > \delta \end{cases}$$

Thus the DF for $n(x)$ is $mN_s(\delta_2/a) - mN_s(\delta_1/a)$.

Example 9.2

Determine the DF of the symmetrical odd double valued nonlinearity shown in Figure 9.2 for input amplitudes $a > \delta$.

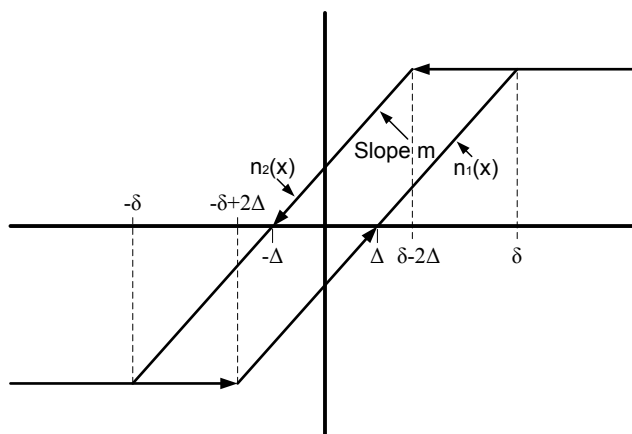

Figure 9.2 Odd symmetric double valued nonlinearity.

Using the approach of reference 2 chapter 3 the in phase and quadrature nonlinearities $n_p(x)$ and $n_q(x)$ are as shown in Figure 9.3

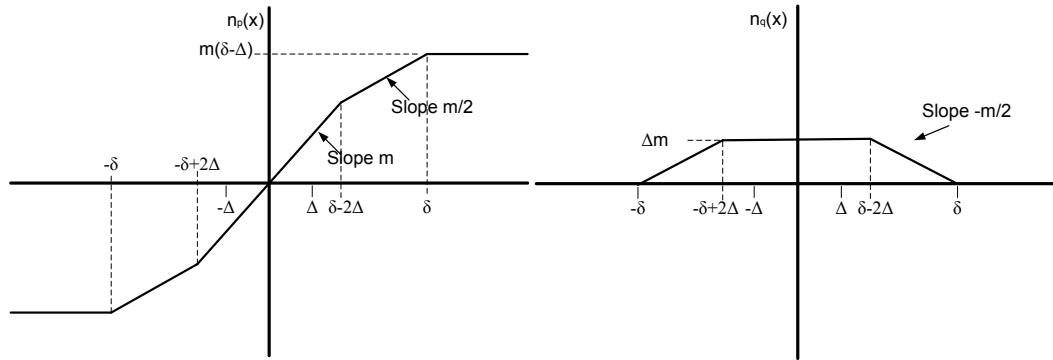

Figure 9.3 In phase and quadrature nonlinearities for nonlinearity of figure 9.2

The describing function $N(a) = N_p(a) + jN_q(a)$ where $N_p(a) = (4/a^2) \int_0^a x n_p(x) p(x) dx$ and $N_q(a) = (-4/a^2 \pi) \int_0^a n_q(x) dx$. For the above characteristics it can be seen that $N_p(a)$ can be synthesised as two ideal saturation characteristics in parallel both of linear slope $m/2$ and with saturation taking place for input levels of $\delta - 2\Delta$ and δ , respectively. Thus $N_p(a) = (m/2)[N_s\{(\delta - 2\Delta)/a\} + N_s(\delta/a)]$ and $N_q(a) = (-4/a^2 \pi) \int_0^a n_q(x) dx = (-4/a^2 \pi) \{m\Delta(\delta - 2\Delta) + m\Delta^2\} = -4m\Delta(\delta - \Delta)/a^2 \pi$ which is (the area of the nonlinearity loop) $/ -a^2 \pi$.

Example 9.3

Figure 9.4 shows the block diagram of a nonlinear network consisting of an absolute value (modulus) block, a multiplier, an ideal differentiator and an ideal relay with outputs of ± 1 . {Note:- if the transfer function of the block before the relay is $1 + sT$ not s , then the network is known as a span filter – see reference 9.2 section 11.6 and Problem 9.6}. Show that its describing function is $(2/\pi)e^{j\pi/2}$ and check this by Fourier analysis in Simulink

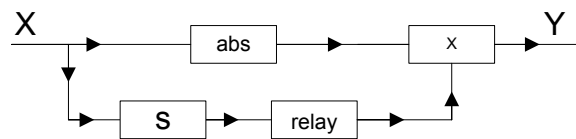

Figure 9.4 Nonlinear network

The output waveform, $y(t)$, for an input, $x(t) = a \sin \omega t$, is shown in Figure 9.5 obtained from the simulation of Figure 9.6.

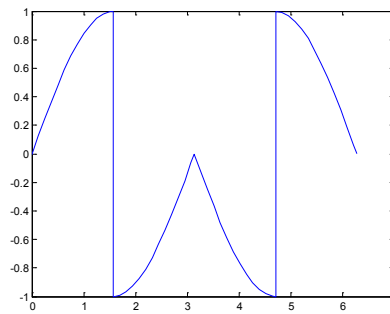

Figure 9.5 Output waveform $y(t)$

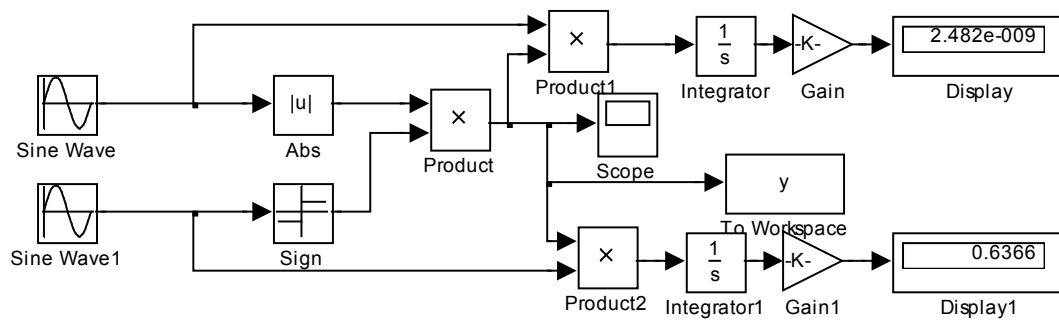

Figure 9.6 Simulink diagram for the determination of the fundamental of $y(t)$



**WE ARE SHAPING
MOBILITY FOR
TOMORROW**

How will people travel in the future, and how will goods be transported? What resources will we use, and how many will we need? The passenger and freight traffic sector is developing rapidly, and we provide the impetus for innovation and movement. We develop components and systems for internal combustion engines that operate more cleanly and more efficiently than ever before. We are also pushing forward technologies that are bringing hybrid vehicles and alternative drives into a new dimension – for private, corporate, and public use. The challenges are great. We deliver the solutions and offer challenging jobs.

www.schaeffler.com/careers

SCHAEFFLER



Click on the ad to read more

In the simulation a frequency of 1 rad/s. has been used for $x(t)$; the simulation taken over a time of 2π ; and the derivative block has been omitted with the signal at the relay input replaced by $a \cos \omega t$. Note that (i) because of the sign (relay) block the amplitude of this signal is immaterial and (ii) because of the lack of dynamics there is no transient involved. (Note to do Fourier analysis of the output waveform from a dynamic system one has to obtain the steady state waveform which only results after any transient has decayed.)

Since the waveform of $y(t)$ is even it has no fundamental sine component and the cosine component is given by $b_1 = (4/\pi) \int_0^{\pi/2} a \sin \theta \cos \theta d\theta = (4a/\pi)(1/4) \cos 2\theta \Big|_0^{\pi/2} = 2a/\pi$. Thus the describing function is $(2/\pi)e^{j\pi/2}$. This is confirmed by the simulation of Figure 9.6, where $a = 1$, with the sinusoidal component given by the display box being zero and the cosinusoidal component given by the display1 box being 0.636. Confirmation that the DF is independent of the input sinusoidal amplitude, a , is obtained by varying a .

Example 9.4

A position control system with no input is modelled as a second order differential equation and has the state equations

$$\dot{x}_1 = x_2 \quad \text{and} \quad \dot{x}_2 = -4x_1 - kx_2 - cx_2 \mid x_2 \mid$$

where x_1 is the position and x_2 the velocity. The damping term kx_2 is provided by a velocity feedback signal so that the value of k can be adjusted by the designer. Assuming the sign of the damping term kx_2 is reversed calculate using the DF method the amplitude of the limit cycle in the system at both position and velocity. The value of c is unknown and therefore the designer decides to do an experiment to estimate c by taking $k = -2$ and measuring the amplitude and frequency of the resulting limit cycle in x_1 and x_2 . Calculate what these values are predicted to be by the describing function method if $c = 0.5$. Which measurement do you expect to give the best estimate for c ? Do the simulation and check these estimates for c .

The easiest way to solve the problem is to recognise that if both the terms in x_2 are removed from the second state equation then one has an ideal oscillator of frequency $\omega = 2$ rads/s. Replacing the third term in the second equation by its describing function equivalent with x_2 having amplitude a , then the last two terms are zero when $-ka - cN(a)a = 0$, which gives $N(a) = c/k$. For the given nonlinearity $N(a) = 8a/3\pi$, which gives $a = 3\pi c/8k$. Since the estimated frequency is 2 rads/s the amplitude of x_1 will equal $3\pi c/16k$, half the amplitude of x_2 .

For the given values of c and k the two amplitudes are 4.71 and 2.35. Which of the two is most accurately predicted by the describing function is not easy to ascertain because although the x_1 limit cycle is more sinusoidal the describing function analysis is based on assuming x_2 to be a sinusoid. Also in doing this procedure in practice one would probably measure the peak to peak amplitude of the signals rather than perform a Fourier analysis to obtain the fundamental values. A simulation shows both waveforms near to sinusoids of 2 rads/s with peak amplitudes of 4.71 and 2.42, respectively. Thus for these measurements the velocity amplitude appears best but whichever is used the error is relatively small.

Example 9.5

Obtain using the describing function method the amplitude and frequency of the limit cycle in the output C for the system described by the block diagram of Figure 9.7 if $G(s) = 1/(s - 2)$ and the nonlinearity NL is $0.5x |x|$.

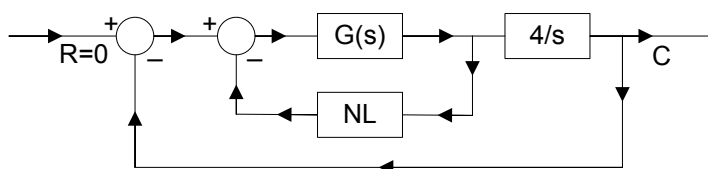

Figure 9.7 Block diagram for Example 9.5

It can be seen that this is essentially the same system as covered in the previous example, however shown in this form an alternative approach is suggested of assuming the loop open at NL, denoting the NL input and output by e_o, e_i respectively and finding the ratio of $-e_o / e_i$. Doing this gives $(4e_o / s) - e_i = e_o / G(s)$, from which $\frac{-e_o}{e_i} = \frac{sG(s)}{s + 4G(s)} = \frac{s}{s^2 - 2s + 4}$. The Nyquist plot of this is given by $\frac{j\omega}{-\omega^2 - 2j\omega + 4}$ which is seen to have a phase of -180° at 2rads/s and a magnitude of -0.5. The Nyquist plot is shown in Figure 9.8. The describing function for the nonlinearity $N(a) = 0.5(8a/3\pi)$, thus $C(a) = -1/N(a) = -3\pi/4a$ is on the negative real axis of the Nyquist plot moving towards the origin as a increases. The solution for the amplitude is given by $(-3\pi/4a) = -0.5$, that is $a = 4.71$, as before. The intersection between the Nyquist plot and $C(a)$ is in the direction required for a stable limit cycle.

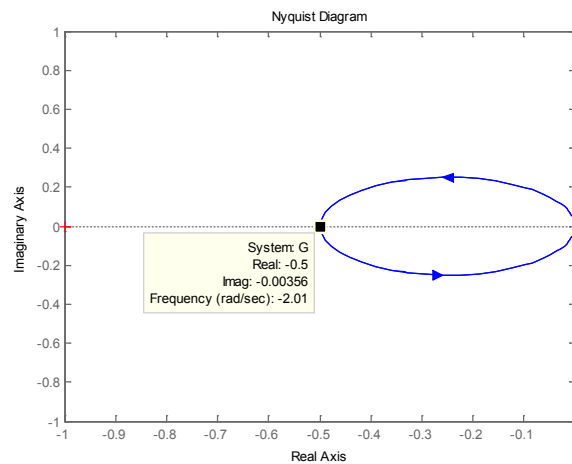

Figure 9.8 Nyquist plot for the frequency response in Example 9.5

Example 9.6

A closed loop system with unit negative feedback contains in its forward path an on off relay with dead zone, switching at $\pm \delta$ and having output levels of 0 and $\pm h$, and a plant with transfer function

$G(s) = \frac{K\omega_o^2}{s(s^2 + 2\zeta s\omega_o + \omega_o^2)}$. Show that the system will be stable if $0 < K < \pi\zeta\omega_o\delta / h$. If $K = 2\pi\zeta\omega_o\delta / h$ show that the system has a stable limit cycle with amplitude of approximately 3.9δ and frequency ω_o .

The transfer function $G(j\omega)$ has a phase shift of -180° when the quadratic term has a phase shift of -90° . This is obviously the case when $\omega = \omega_o$ and the corresponding gain is $K\omega_o^2 / [\omega_o(2\zeta\omega_o^2)] = K / 2\zeta\omega_o$. The describing function for a relay with dead zone (see Appendix 3.11 reference 2), $N(a) = 4h(a^2 - \delta^2)^{1/2} / a^2\pi$ for $a > \delta$ and 0 for $a < \delta$. This is easily shown by differentiation to have a maximum value when $a = \sqrt{2}\delta$ of $N_{\max}(a) = 2h / \pi\delta$. The $C(a) = -1 / N(a)$ locus on a Nyquist plot thus starts at $-\infty$ on the negative real axis, increases as a increases up to $-\pi\delta / 2h$ and then returns to $-\infty$. If the gain K is large enough the Nyquist plot of $G(j\omega)$ will cut $C(a)$ from below, so that according to the Loeb intersection criterion the smaller value of a at the intersection point will correspond to an unstable limit cycle and the larger value of a to a stable one. Thus for stability the maximum gain is given by $(K / 2\zeta\omega_o)(2h / \pi\delta) = Kh / \pi\zeta\omega_o\delta < 1$, giving $0 < K < \pi\zeta\omega_o\delta / h$.

For $K = 2\pi\zeta\omega_o\delta / h$ the gain of $G(j\omega)$ when its phase is -180° is $\pi\delta / h$ and therefore the amplitude of a limit cycle solution with frequency ω_o is given by $\{4h(a^2 - \delta^2)^{1/2} / a^2\pi\} \{\pi\delta / h\} = 1$. Taking $x = \delta / a$ then the expression yields the quadratic equation in x^2 of $16x^4 - 16x^2 + 1 = 0$, which has solutions of $x = \sqrt{(2 \pm \sqrt{3}) / 4}$, for which the smallest positive value is $x = 0.259$, yielding $a = 3.86\delta$.

Example 9.7

A closed loop system with unit negative feedback contains in its forward path an on off relay with hysteresis of $\pm \Delta$ and output levels of ± 1 , and a plant with transfer function $G(s) = \frac{10(2-s)}{(2+s)(1+s)}$. For no input to the system use the DF method to estimate the amplitude and frequency of the limit cycle at the input to the relay for values of Δ equal to 0, 1 and 2, respectively. Compare the results with measured values from simulations.

For the on off relay with hysteresis the describing function (see Appendix 3.11 reference 2) is given by $N(a) = (4h/a^2\pi)\{(a^2 - \Delta^2)^{1/2} - j\Delta\}$ for $a > \Delta$. Thus the $C(a)$ locus is given by $C(a) = (-\pi/4h)\{(a^2 - \Delta^2)^{1/2} + j\Delta\}$ and it is seen that the imaginary part is independent of a , thus the $C(a)$ loci are lines parallel to the negative real axis and a distance $\pi\Delta/4h$ below for different values of Δ . Now the frequency response $G(j\omega) = \frac{10(2-j\omega)}{(2+j\omega)(1+j\omega)}$ has $\text{Re}\{G(j\omega)\} = \frac{10(4-5\omega^2)}{(4+\omega^2)(1+\omega^2)}$ and $\text{Im}\{G(j\omega)\} = \frac{10\omega(\omega^2-8)}{(4+\omega^2)(1+\omega^2)}$ so the frequency of the limit cycle can be found directly from $\frac{10\omega(8-\omega^2)}{(4+\omega^2)(1+\omega^2)} = \frac{\pi\Delta}{4}$ as $h = 1$. This can be written $\Delta = \frac{40\omega(8-\omega^2)}{\pi(4+\omega^2)(1+\omega^2)} = f(\omega)$. Once ω is found from this equation for the given values of Δ then the amplitude a of the oscillation at the relay input can be found from $\frac{\pi(a^2 - \Delta^2)^{1/2}}{4} = \frac{10(5\omega^2 - 4)}{(4+\omega^2)(1+\omega^2)}$. The graph of $f(\omega)$, where ω is replaced by x , is shown in Figure 9.9 computed from the Matlab program

```
% f(x) for example 9.7
x=linspace(1.2,3,50);
f=(40/pi).*x.*(8-x.*x)./((4+x.*x).*(1+x.*x));
plot(x,f)
grid
```

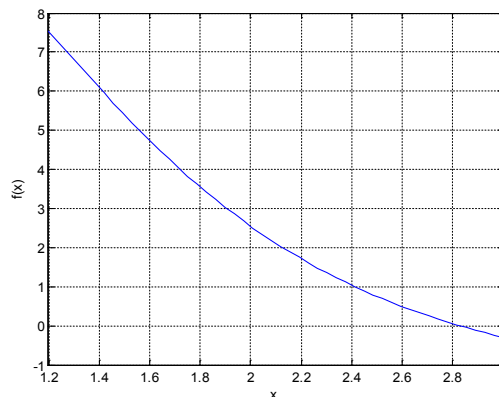

Figure 9.9 Graph of $f(x)$ for example 9.6.

This shows that the solutions for ω are respectively 2.83, 2.41 and 2.13 rad/s, with as expected the frequency of the limit cycle decreasing as Δ increases. The equation for the amplitude of the limit cycle can be written $a = \left\{ \Delta^2 + \left[\frac{40(4 - 5\omega^2)}{\pi(4 + \omega^2)(1 + \omega^2)} \right]^2 \right\}^{1/2}$, which gives the corresponding amplitudes as 4.24, 4.88 and 5.42, respectively.

The actual limit cycles from simulations are shown in Figure 9.10 for $\Delta = 0$ and $\Delta = 2$, which are quite distorted. For the three values of Δ the measured amplitudes and frequencies are 5.0 and 2.4 rad/s; 5.9 and 2.1 rad/s; and 6.6 and 1.9 rad/s. As expected (i) due to the appreciable distortion in the limit cycles which show a 'peaky effect' the fundamental amplitude, the DF estimate, is less than the measured magnitude and (ii) the frequency predicted by the DF method is higher than the actual frequency (From comparison of Nyquist locus $G(j\omega)$ and $A_G^o(0, \omega)$).

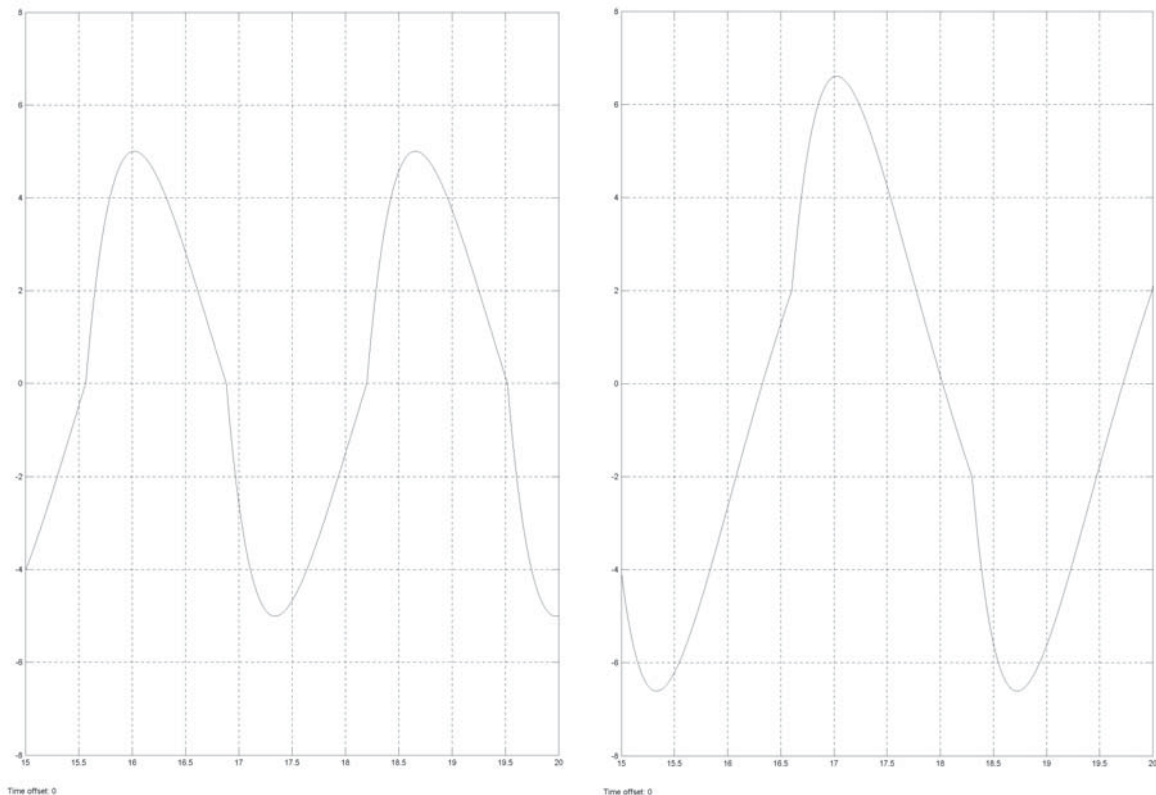

Figure 9.10 Limit cycles for $\Delta = 0$ (left) and $\Delta = 2$ (right).

Example 9.8

Repeat the DF calculations of example 9.7 for the transfer function $G(s) = \frac{10e^{-(s/2)}}{(1+s)}$ {Note that a first order approximation for $e^{-(s/2)}$ is $\frac{2-s}{2+s}$ }.

Since $e^{-j\omega/2} = \cos(\omega/2) - j \sin(\omega/2)$ this gives $\operatorname{Re}\{G(j\omega)\} = \frac{10[\cos(\omega/2) - \omega \sin(\omega/2)]}{(1 + \omega^2)}$ and

$\operatorname{Im}\{G(j\omega)\} = \frac{-10[\omega \cos(\omega/2) + \sin(\omega/2)]}{(1 + \omega^2)}$. Thus for the limit cycle frequency

$\Delta = \frac{40[\cos(\omega/2) - \omega \sin(\omega/2)]}{\pi(1 + \omega^2)} = f(\omega)$, which is again plotted in Figure 9.11 as $f(x)$ against x , from

which for a given Δ the frequency ω can be found.

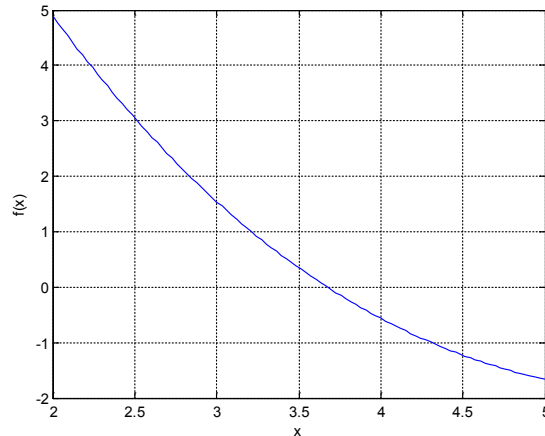

Figure 9.11 Graph showing the relationship between the value of the hysteresis and the limit cycle frequency for example 9.8.

**STUDY FOR YOUR MASTER'S DEGREE
IN THE CRADLE OF SWEDISH ENGINEERING**

Chalmers University of Technology conducts research and education in engineering and natural sciences, architecture, technology-related mathematical sciences and nautical sciences. Behind all that Chalmers accomplishes, the aim persists for contributing to a sustainable future – both nationally and globally.

Visit us on **Chalmers.se** or **Next Stop Chalmers** on facebook.

CHALMERS
UNIVERSITY OF TECHNOLOGY



Click on the ad to read more

For Δ equal to 0, 1, 2 the values of ω are respectively, 3.67, 3.21 and 2.84, and the corresponding amplitudes from $a = \{\Delta^2 + [\frac{40(-\cos(\omega/2) + \omega \sin(\omega/2))}{\pi(1 + \omega^2)}]^2\}^{1/2}$ are 3.34, 3.79 and 4.23. Note that although the previous example uses a first order approximation for the time delay there is a reasonable difference between the solutions as the Nyquist loci for the two transfer functions differ quite significantly when the phase lag is near to 180° , as shown in Figure 9.12. The inner frequency plot marked time delay being the transfer function of this example.

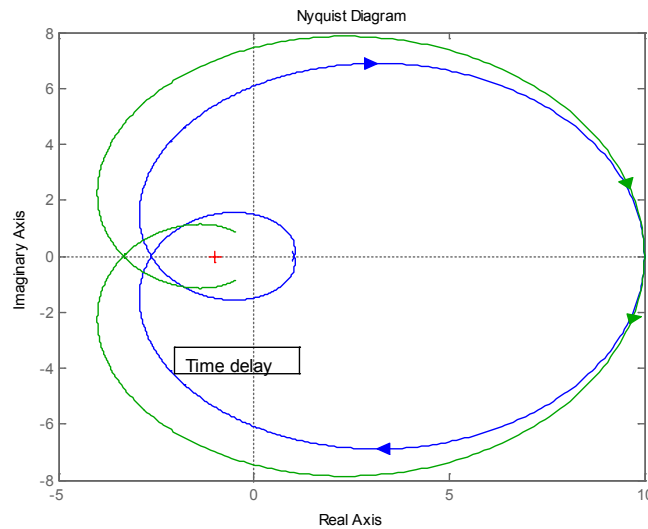

Figure 9.12 Nyquist plots of transfer functions in examples 9.7 and 9.8.

Example 9.9

A closed loop system with unit negative feedback contains in its forward path an on off relay with hysteresis Δ of ± 1 and output levels of h of ± 1 , and a plant with transfer function $G(s) = \frac{10}{(1+s)^3}$. The input, R , to the system is constant. Do calculations using the describing function for the on off ratio at the output of the relay and the frequency of the limit cycle for constant input values of R equal to 0, 2 and 4. Compare the results with those from simulations.

To solve the problem the describing function for an on off relay with hysteresis having a sinusoidal plus bias input is required. It can be found in Appendix A2 of reference 9.2 but it is calculated here. Taking the input as $\gamma + a \sin \theta$, then the output of the nonlinearity will switch to 1 when $\gamma + a \sin \theta_1 = \Delta$ and to -1 when $\gamma + a \sin(\pi + \theta_2) = -\Delta$, so that $\theta_1 = \sin^{-1}\{(\Delta - \gamma) / a\}$ and $\theta_2 = \sin^{-1}\{(\Delta + \gamma) / a\}$. The in phase fundamental output is

$$b_1 = (1/\pi) \left\{ \int_0^{\theta_1} -h \sin \theta d\theta + \int_{\theta_1}^{\pi+\theta_2} h \sin \theta d\theta + \int_{\pi+\theta_2}^{2\pi} -h \sin \theta d\theta \right\} = (2h/\pi) \{ \cos \theta_1 + \cos \theta_2 \}$$

and the quadrature component is

$$a_1 = (1/\pi) \left\{ \int_0^{\theta_1} -h \cos \theta d\theta + \int_{\theta_1}^{\pi+\theta_2} h \cos \theta d\theta + \int_{\pi+\theta_2}^{2\pi} -h \cos \theta d\theta \right\} = (2h/\pi) \{ \sin \theta_1 + \sin \theta_2 \} = 4h\Delta/a\pi.$$

The bias output is $(1/2\pi)(-h\theta_1 + h(\pi + \theta_2 - \theta_1) - h\{2\pi - (\pi + \theta_2)\}) = (h/\pi)(\theta_2 - \theta_1) = h\alpha/\pi$, where $\alpha = \theta_2 - \theta_1$. Thus the describing function expressions for the fundamental and bias signal are

$$N_a(a, \gamma) = (2h/a\pi)(\cos \theta_1 + \cos \theta_2) - j(4h\Delta/a\pi) \text{ and } N_\gamma(a, \gamma) = (h/\gamma\pi)(\theta_2 - \theta_1).$$

The equations to balance the fundamental and bias around the loop are

$$N_a(a, \gamma)G(j\omega) = -1 \text{ and } R - 10\gamma N_\gamma(a, \gamma) = \gamma$$

The first equation yields two equations from the real and imaginary parts, so that there are three equations to solve for the three unknowns ω , a and γ for given values of R . The simplest form of the first two equations is probably obtained by writing $N_a(a, \gamma) = -1/G(j\omega)$. The three equations with the unity values for h and Δ substituted are

$$3\omega^2 - 1 = (2/a\pi)(\cos \theta_1 + \cos \theta_2), \quad \omega^3 - 3\omega = -4/a^2\pi \text{ and } R - (10/\pi)(\theta_2 - \theta_1) = \gamma.$$

The equations can be easily solved in Matlab using an algorithm such as `fminsearch` and the results obtained are respectively for ω , a and γ ; 1.3258, 2.7804 and 0.0000; 1.3289, 2.7860 and 0.5750; 1.3225, 2.7742 and 1.1133; for $R = 0, 2$ and 4 respectively. The third of the above equations can be written $\alpha/\pi = (R - \gamma)/10$ and therefore the on off ratio, ρ , given by $\rho = (\pi + \alpha)/(\pi - \alpha) = (10 + R - \gamma)/(10 - R + \gamma)$ yields the corresponding values for ρ of 1.0000, 1.3323 and 1.8117. It can be seen that the results show a negligible change in the frequency and fundamental amplitude of the limit cycle. In the simulations the peak amplitude of the limit cycles was measured and the results are compared with the theory in Table 9.1.

	Calculated	Calculated	Calculated	Measured	Measured	Measured
R	ω	a	ρ	ω	Peak amp.	ρ
0	1.326	2.780	1.000	1.30	2.83	1.00
2	1.329	2.786	1.332	1.29	2.81	1.33
4	1.323	2.774	1.812	1.24	2.80	1.83

Table 9.1 Comparison of calculated and simulation results.

When R is increased sufficiently the limit cycle disappears and the relay output remains fixed at unity, the theoretical limit for this value of R from the above expressions is 6.13 whereas in the simulation it is approximately 9.0. This is, of course, a large difference and is due to the fact that the distortion in the limit cycle waveform increases significantly, mainly due to second harmonic content, as R increases, and the accuracy of the DF solution therefore deteriorates.

Example 9.10

A closed loop system with unit negative feedback contains in its forward path a gain compensator, an on off relay with dead zone, switching at ± 1 and having output levels of 0 and ± 1 , and a plant with transfer function $G(s) = \frac{1}{s(1+s)^2}$. Determine using the describing function method the maximum value of gain, K , which may be placed in the compensator before the system goes unstable? Check your result by simulation. Calculate the value of the frequency and amplitude of the limit cycle at the relay input when the compensator has a gain of 6 and compare with simulation results.

The DF for the relay with dead zone is $N(a) = (4h/a^2\pi)(a^2 - \delta^2)^{1/2}$ which has a maximum value of $N(a)_{\max} = 2h/\pi\delta$. $\angle G(j\omega) = -180^\circ$ when $\omega = 1$ and the corresponding magnitude is $|G(j\omega)|_{\omega=1} = \frac{1}{\omega(1+\omega^2)} = \frac{1}{2}$. Thus instability will occur with a compensator gain of K when $\frac{2h}{\pi\delta} \cdot \frac{K}{2} > 1$, that is $K > \pi\delta/h$, giving $K > \pi$ for $\delta = h = 1$.



Scholarships

Open your mind to new opportunities

With 31,000 students, Linnaeus University is one of the larger universities in Sweden. We are a modern university, known for our strong international profile. Every year more than 1,600 international students from all over the world choose to enjoy the friendly atmosphere and active student life at Linnaeus University. Welcome to join us!

Linnaeus University
Sweden

Ln.se

Bachelor programmes in
Business & Economics | Computer Science/IT | Design | Mathematics

Master programmes in
Business & Economics | Behavioural Sciences | Computer Science/IT | Cultural Studies & Social Sciences | Design | Mathematics | Natural Sciences | Technology & Engineering

Summer Academy courses

The system was simulated in Simulink as shown in Figure 9.13, with no step input. An initial condition of 4 was placed on the integrator and the gain, K , in the gain block varied. For a gain of 3 the response persisted for over 200 seconds.

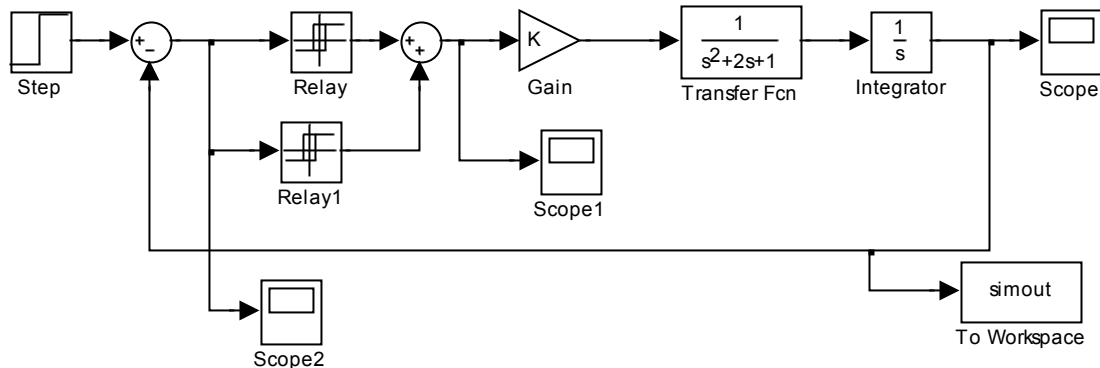

Figure 9.13 Simulink diagram for Example 9.10

For $K = 6$ the system is unstable with a limit cycle of frequency 1 rad/s. and amplitude given by $\frac{6}{2} \cdot \frac{4}{a^2 \pi} (a^2 - 1)^{1/2} = 1$ giving $a^2 - 1 = a^4 \pi^2 / 144$, which has solutions of $a = 1.04$ and 3.68 with the latter being the stable solution. In the simulation the amplitude of the limit cycle was 3.61.

Example 9.11

Discuss the stability of the feedback loop of Figure 9.14 if $G_1(s) = K / (s + 2)$, $G_2(s) = 1 / (s + 1)$ and NL is an ideal saturation characteristic with unit slope in the linear regime and saturating at inputs of ± 1 . If $K = 8$ determine the amplitude and frequency of any possible limit cycle.

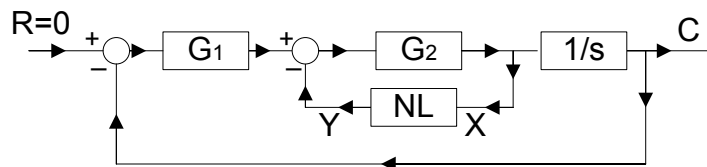

Figure 9.14 Block diagram for Example 9.11

Here a quick appreciation of the situation can be assessed by considering the bounds of the describing function for saturation, $N(a)$, in the system characteristic equation which is $s(s+2)(s+1+N(a)) + K = s^3 + \{3 + N(a)\}s^2 + 2\{1 + N(a)\}s + K = 0$. For stability $K < 2\{3 + N(a)\}\{1 + N(a)\}$ which equals 6 for $N(a) = 0$ and 16 for $N(a) = 1$. Thus, for $K = 8$, there is the possibility of a limit cycle for larger values of a . To calculate its value at the input to the nonlinearity, X , the negative of the transfer function from Y to X with NL removed (the equivalent open loop transfer function) is required. This is $G_{ol}(s) = \frac{-X}{Y} = \frac{sG_2}{s + G_1G_2} = \frac{s(s+2)}{s^3 + 3s^2 + 2s + 8}$. The Nyquist plot in Matlab shows that this transfer function has a phase of -180° when $\omega = 1.58$ and it crosses the negative real axis from positive to negative imaginary values, which means the limit cycle is unstable, at -4.23 . Thus $N(a) = 1/4.23 = 0.236$. Figure 9.15 shows the DF plot for saturation with $\delta = 1$ for amplitudes greater than unity from which it can be seen that the corresponding value of a is around 5.4 (more accurate value is 5.36). In practice with initial conditions on the output integrator simulations showed that the response went unstable for an initial condition greater than 4 (note that in terms of the limit cycle this corresponds to an amplitude of $4\omega = 4 * 1.58 = 6.32$ at the relay input).

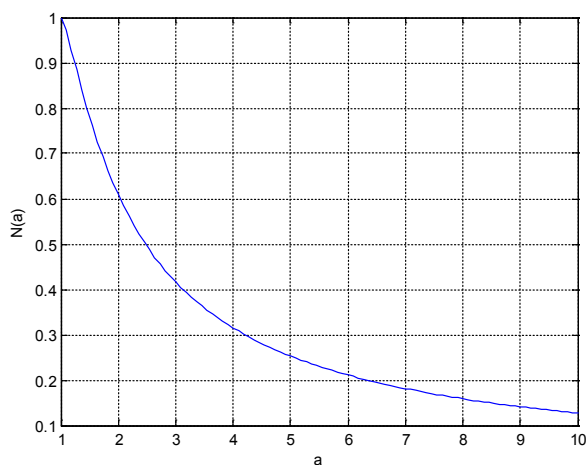

Figure 9.15 Describing function for ideal saturation.

Example 9.12

The block diagram of Figure 9.16 shows a feedback system with two nonlinear elements. NL_1 is a saturation characteristic with unit slope and saturation levels and NL_2 is a cubic. If $G_c(s) = \frac{1+2s}{1+0.25s}$, $G_1(s) = \frac{10}{(1+2s)(1+0.5s)}$, and $G_2(s) = \frac{1}{s}$, show that the system possesses a limit cycle and find its frequency and amplitude at the input to the two nonlinearities.

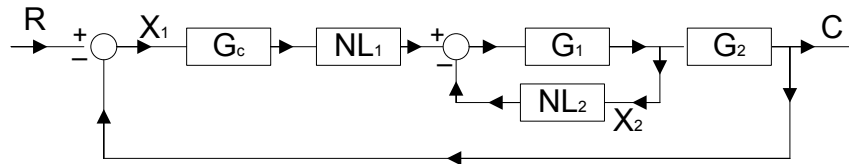

Figure 9.16 Block diagram for Example 9.12







- The number 1 MOOC for Primary Education
- Free Digital Learning for Children 5-12
- 15 Million Children Reached

About e-Learning for Kids Established in 2004, e-Learning for Kids is a global nonprofit foundation dedicated to fun and free learning on the Internet for children ages 5 - 12 with courses in math, science, language arts, computers, health and environmental skills. Since 2005, more than 15 million children in over 190 countries have benefitted from eLessons provided by EFK! An all-volunteer staff consists of education and e-learning experts and business professionals from around the world committed to making difference. eLearning for Kids is actively seeking funding, volunteers, sponsors and courseware developers; get involved! For more information, please visit www.e-learningforkids.org.



Representing the DFs of the two nonlinearities by $N_1(a_1)$ and $N_2(a_2)$ respectively, the forward transfer function of the loop is $N_1(a_1)G_f(s)$ where $G_f(s) = \frac{(1+2s)}{s(1+0.25s)} \frac{10}{\{s^2 + 2.5s + 1 + 10N_2(a_2)\}}$. For small amplitudes $N_1(a_1) = 1$ and $N_2(a_2) = 0$, thus the loop will be unstable if $G_f(s)$ with $N_2(a_2) = 0$ is unstable with unity negative feedback. The characteristic equation for this situation is $s^4 + 6.5s^3 + 11s^2 + 84s + 40 = 0$ which has a complex pair of roots with a positive real part and is thus unstable. As the amplitudes increase $N_1(a_1)$ will become less than unity as a_1 becomes greater than unity and $N_2(a_2)$ will continue to increase as a_2 increases. Both these effects will help to 'stabilise a limit cycle' in the feedback loop and the relationship between a_1 and a_2 will depend upon the frequency of the limit cycle according to $a_1 = a_2 \frac{(1+4\omega^2)^{1/2}}{\omega\{1+(\omega^2/16)\}^{1/2}}$. One way to solve the problem is to select values for $N_2(a_2)$, or a_2 since $N_2(a_2) = 3a_2^2/4$, then find the values of ω for which $G_f(j\omega)$ will have a phase shift of -180° and the corresponding magnitudes $|G_f(j\omega)|$. Values of a_1 can be calculated from the above equation for the corresponding values of ω , then $N_1(a_1)$ using the known DF for saturation and finally the value of $N_1(a_1)|G_f(j\omega)|$. The solution is then that combination of ω , a_1 and a_2 for which $N_1(a_2)|G_f(j\omega)| = 1$. Table 9.2 shows computed values for this process for values of $10N_2(a_2)$ from 5 to 8. The values for ω for -180° of G_f and $|G_f|$ can be found using the margin function in Matlab. From the Table it is easily seen that the required solution will exist for a frequency between 3.84 and 3.97 rads/s. Further iteration gives the required solution values as $\omega = 3.89$, $a_1 = 1.33$ and $a_2 = 0.920$. The corresponding three values measured from the simulation were, 3.88, 1.32 and 0.937, respectively, where the last two numbers are peak amplitudes. The simulations show that both waveforms at the nonlinearity inputs are near sinusoidal, hence the good predictions of the DF method.

$10N_2(a_2)$	5.00	6.00	7.00	8.00
a_2	0.8165	0.8944	0.9661	1.0328
ω for -180° of G_f	3.69	3.84	3.97	4.10
$ G_f $ dB	1.84	1.46	1.10	0.739
$ G_f $	1.236	1.183	1.135	1.089
a_1	1.211	1.301	1.382	1.453
$N_1(a_1)$	0.915	0.871	0.833	0.763
$N_1(a_1) G_f $	1.131	1.030	0.945	0.831

Table 9.2 Calculations to iterate to the limit cycle solution for Example 9.12

The simulink diagram for the simulation is given in figure 9.17

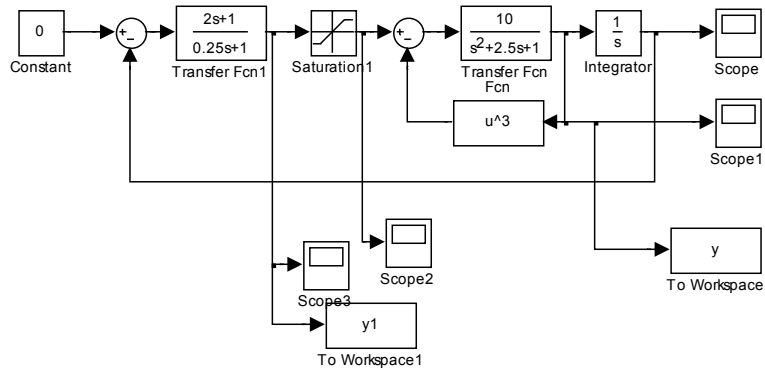

Figure 9.17 Simulink diagram for Example 9.12

Example 9.13

Here we examine the stability of the feedback loop of Example 8.8, which has a simple backlash nonlinearity model, using the DF.

The DF for this backlash model is derived in reference 9.2 but will be repeated here as an example of working out the DF, as it is a special form of multi-valued nonlinearity. The nonlinearity and its in-phase and quadrature characteristics are shown in Figure 9.18 for an input amplitude a , where $a > b/2$

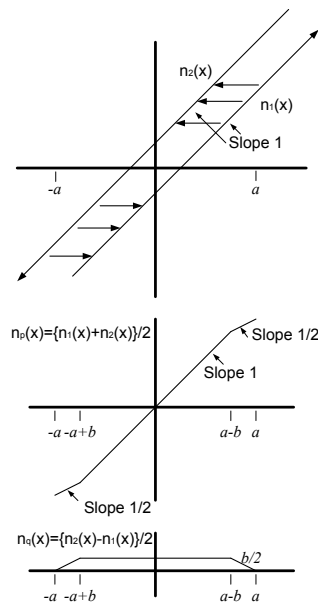

Figure 9.18 Backlash and its in-phase and quadrature nonlinearities

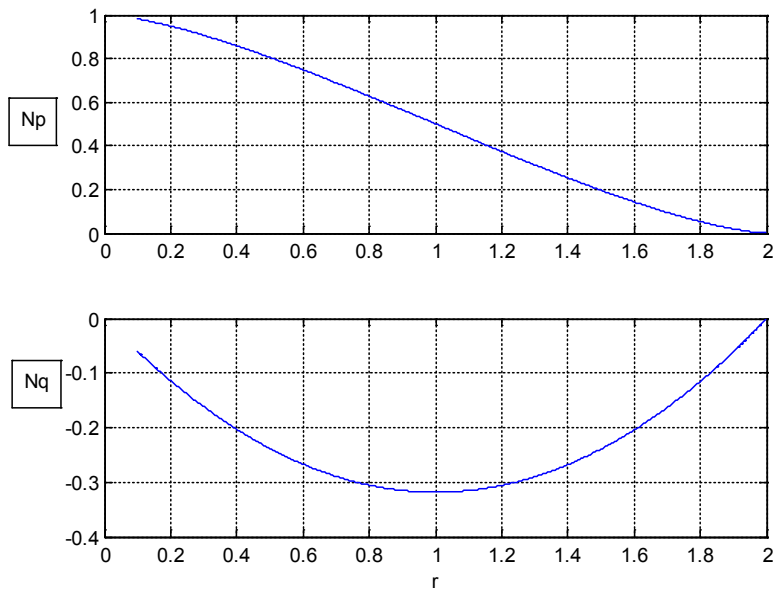

Figure 9.19 In-phase and quadrature DF components.

.....Alcatel-Lucent 

www.alcatel-lucent.com/careers

What if you could build your future and create the future?

One generation's transformation is the next's status quo. In the near future, people may soon think it's strange that devices ever had to be "plugged in." To obtain that status, there needs to be "The Shift".



It can be seen that the in-phase nonlinearity is the equivalent of a linear gain of 0.5 and an ideal saturation characteristic of linear gain 0.5 and saturating at $a - b$. Then the in-phase component of the DF is $N_p(a) = 0.5 + 0.5N_s([a - b]/a)$, where N_s is the DF of ideal saturation. The quadrature component $N_q(a)$ is the negative of twice the area under $n_q(x)$ divided by $a\pi$, thus $N_q(a) = (-4/a\pi)[(b/2)(a - b) - b^2/4] = b(b - 2a)/a\pi$. The DF $N(a) = N_p(a) + jN_q(a)$. Figure 9.19 shows graphs of N_p and N_q plotted against $r = b/a$, for $a > 2b$, that is $r < 2$. For the transfer function $K/s(s + 1)$, Figure 9.20 shows Nyquist plots of the frequency response for $K = 2, 4$ and 16 together with $C(a) = -1/N(a)$, from which it can be seen that for the two higher values of Ka limit cycle is predicted. Additional Nyquist plots predict no limit cycle for $K < 3.5$. This compares with a value of around $K < 2.3$ found from simulation of the system. {Note. This is a limit cycle approximately equal to the backlash width}.

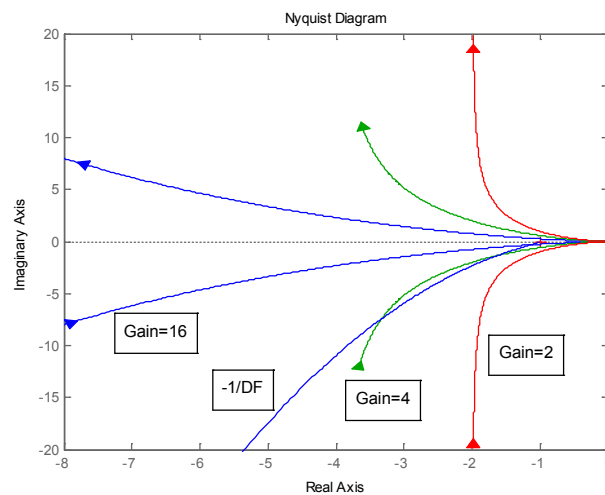

Figure 9.20 Nyquist plots for different K together with $C(a) = -1/N(a)$

Example 9.14

Use the Tsypkin method to determine the frequency of the limit cycle in a negative feedback loop containing an ideal relay and the transfer function $G(s) = 1/(1 + s)(1 + sT_1)(1 + sT_2)$. Obtain the solution for $T_1 = 2$ and $T_2 = 4$ and compare it with the DF solution.

Putting the transfer function into partial fractions gives $G(s) = \frac{A}{1+s} + \frac{B}{1+sT_1} + \frac{C}{1+sT_2}$ where $A = \frac{1}{(1-T_1)(1-T_2)}$, $B = \frac{T_1^2}{(T_1-1)(T_1-T_2)}$ and $C = \frac{T_2^2}{(T_2-1)(T_2-T_1)}$. Now the solution for the limit cycle is given by $\text{Im } A_G^o(0, \omega) = 0$ where for the transfer function $1/(1+sT)$, $\text{Im } A_G^o(0, \omega) = -\lambda C_{0,1}^o(0, \omega) = -\frac{\pi}{4} \tanh \frac{\pi}{2\lambda}$, since $S_{-1,1}^o(0, \omega) = 0$ and where $\lambda = \omega T$. The solution for the limit cycle frequency is thus given by $A \tanh \frac{\pi}{2\omega} + B \tanh \frac{\pi}{2\omega T_1} + C \tanh \frac{\pi}{2\omega T_2} = 0$. The DF solution for the problem is $\tan^{-1} \omega + \tan^{-1} \omega T_1 + \tan^{-1} \omega T_2 = \pi$.

For the parameters given the Tsypkin solution is given by $\frac{1}{3} \tanh \frac{\pi}{2\omega} - 2 \tanh \frac{\pi}{4\omega} + \frac{8}{3} \tanh \frac{\pi}{8\omega} = 0$. The equation can be easily solved in Matlab using the 'fminsearch' routine as follows:-

```
>> f=@(x) ((1/3)*tanh(pi/(2*x(1)))-2*tanh(pi/(2*x(1)*2)))+(8/3)*tanh(pi/(2*x(1)*4))^2
```

```
f =
```

```
@(x) ((1/3)*tanh(pi/(2*x(1)))-2*tanh(pi/(2*x(1)*2)))+(8/3)*tanh(pi/(2*x(1)*4))^2
```

```
>> fminsearch(f,1)
```

```
ans =
```

```
0.9196
```

The above equation for the DF solution can be solved in a similar way and gives an angular frequency of 0.9354.

[**Note:-** The approximate exact solution for the transfer function $G(s) = 1/(1+s)^3$ can be computed in Matlab by letting $T_1 = 1 + \varepsilon$ and $T_2 = 1 - \varepsilon$, and taking ε small.]

Example 9.15

Obtain an expression which will give the solution for the limit cycle frequency in a negative feedback loop containing a relay with hysteresis and a plant with a time delay using the state space approach, where the plant is described by $(A, B, C, 0)$ and the delay is θ .

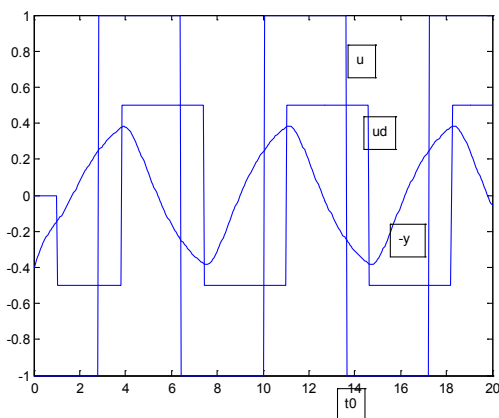

Figure 9.21 Simulation to show sample waveforms.

Figure 9.21 shows typical waveforms for a symmetrical oscillation with the relay switching negative at time t_0 and with the delay assumed to occur after the relay. The waveform labelled 'u' is a scaled version of the relay output, the input to the plant is 'ud' delayed by θ from 'u' and the input to the relay is labelled '-y', that is minus the loop output. The relay switching levels in the simulation are ± 0.25 . The input to the plant is $+h$ for the time period $t_0 < t < t_0 + \theta$ and $-h$ for the period $t_0 + \theta < t < t_0 + T$, where T is the half period of the limit cycle. A state space description of the plant transfer function is $\dot{x} = Ax + Bu$ and $y = Cx$, where B is a column vector and C a row vector. If the state equation is integrated over a time τ from time 0 to τ when u is constant at $+h$ one obtains

$$x(\tau) = e^{A\tau}x(0) + \int_0^{\tau} e^{A(\tau-t)}Bh dt = e^{A\tau}x(t_0) + A^{-1}(e^{A\tau} - I)Bh = e^{A\tau}x(0) + g(\tau)Bh$$

where $g(\tau) = A^{-1}(e^{A\tau} - I)$. Thus for the system over the above two time periods of duration θ and $T - \theta$ one has

$$x(t_0 + \theta) = e^{A\theta}x(t_0) + g(\theta)Bh \text{ and}$$

$x(t_0 + T) = e^{A(T-\theta)}x(t_0 + \theta) - g(T - \theta)Bh$ which on substituting for $x(t_0 + \theta)$ in the second equation gives

$$x(t_0 + T) = e^{A(T-\theta)}\{e^{A\theta}x(t_0) + g(\theta)Bh\} - g(T - \theta)Bh \text{ which becomes}$$

$$x(t_0 + T) = e^{AT}x(t_0) + \{e^{A(T-\theta)}g(\theta) - g(T - \theta)\}Bh$$

Now

$$e^{A(T-\theta)}g(\theta) - g(T-\theta) = e^{A(T-\theta)}A^{-1}(e^{A\theta} - I) - A^{-1}(e^{A(T-\theta)} - I) = A^{-1}(e^{AT} + I - 2e^{A(T-\theta)}) \quad \text{since } e^{kA} = A^{-1}e^{kA}A.$$

For an odd symmetrical limit cycle $x(t_0 + T) = -x(t_0)$, thus

$$x(t_0) = (I + e^{AT})^{-1}A^{-1}(2e^{A(T-\theta)} - e^{AT} - I)Bh.$$

The half period, T , for the limit cycle can then be found from the condition

$$y(t_0) = Cx(t_0) = C(I + e^{AT})^{-1}A^{-1}(2e^{A(T-\theta)} - e^{AT} - I)Bh = \Delta.$$

An equation which is easily solved in Matlab for the value of T when given specific plant parameters $(A, B, C, 0)$ and delay θ .

Example 9.16

Use the result obtained in Example 9.15 to check the limit cycle frequency obtained for the parameters given in Example 9.14.



Nido

Luxurious accommodation

Central zone 1 & 2 locations

Meet hundreds of international students

BOOK NOW and get a £100 voucher from voucherexpress

Nido Student Living - London

Visit www.NidoStudentLiving.com/Bookboon for more info.

+44 (0)20 3102 1060

For $\theta = \Delta = 0$ the solution for the limit cycle frequency is given by $C[\exp(AT) + I]^{-1} A^{-1} [\exp(AT) - I] B h = 0$ which can be solved in Matlab after the parameters (A, B, C) have been entered with the function below for `fminsearch`

$$f=@(x) (C*inv(expm(A*x(1))+I)*inv(A)*(expm(A*x(1))-I)*B)^2$$

or the more general function:-

$$f=@(x) ((C*inv(expm(A*x(1))+I)*inv(A)*(2*expm(A*(x(1)-z))-expm(A*x(1))-I)*B)-d)^2$$

where z is the time delay and d is Δ/h .

It should be noted that the required function for the matrix exponential in Matlab is `expm`. The function `exp` when used with a matrix takes the exponential of the individual matrix terms. $x(1)$ is the solution for the half period T and is 3.4162, which corresponds to an angular frequency of 0.9196, as in Example 9.14.

[**Note:-** The solution involves the inverse of the matrix A , which will not exist when A is singular, for example when the transfer function has a pole at the origin. A solution, however, can be calculated good enough for any engineering purposes by replacing s by $s + \varepsilon$, and making ε small.]

References

9.1 Chung J.K-C. and Atherton D.P., The Determination of Periodic Modes in Relay Systems Using the State Space Approach. International Journal of Control, Volume 4, pp 105–126, 1966.

9.2 Atherton D.P., Nonlinear Control Engineering: Describing Function Analysis and Design. Van Nostrand Reinhold, London, 1975.

9.3 Problems

Problem 9.1

Repeat the procedure of example 9.1 if the state equations for the system are

$$\dot{x}_1 = x_2$$

$$\dot{x}_2 = -4x_1 - kx_2 - cx_2^3$$

$[(4k/3c)^{1/2}, (k/3c)^{1/2}, 2.31, 2.16, \text{peak amplitudes in simulation } 2.32 \text{ and } 1.25]$

Problem 9.2

Calculate the amplitude and frequency of the output limit cycle, C , for the system represented by the block diagram of Figure 9.7 if the nonlinearity NL is $2x^3$ for the two cases of (a) $G(s) = \frac{1}{s^2 - 3s - 2}$ and (b) $G(s) = \frac{s+6}{s^2 - 2}$.

[(a) 1.49, 1.15 (b) 1.11, 3.61]

Problem 9.3

Determine using the DF the amplitude and period of the limit cycle in Problem 8.13.

[2.78, 7.11]

Problem 9.4

A block diagram of a Clegg integrator is shown in Figure P9.4. The zero crossing detector (zcd) and reset gate operate such that one integrator is on when the input X is positive and the other when it is negative, and the integrator outputs are set to zero when there is no integrator input. Show that its DF is independent of the input amplitude, has a magnitude of $1.619/\omega$ and a phase shift of -38.15° .

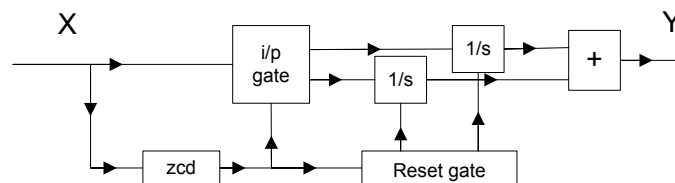

Figure P9.4 Block diagram of Clegg Integrator

Problem 9.5

A Simulink diagram of the limited integrator of Somerville and West (see reference 9.2 page 134) is shown in Figure P9.5, where Gain 1 is $1/T$. Note that the effect of the dead zone feedback through the high Gain K is to limit the integrator output to $\pm V$, where the dead zone is $\pm V$, and it is not the same as limiting the output of the integrator with a saturation characteristic. {Note:- The limited integrator in Simulink implements the same function.} Show that its DF $N(a) = N_p(a) + jN_q(a)$ has:-

$$N_p(a) = \frac{4}{\pi^2}(r - u) \quad \text{and} \quad N_q(a) = -\frac{1}{2\pi u} \{2\alpha - \sin 2\alpha\} \quad \text{for } r \geq u, \text{ and}$$

$$N_p(a) = 0 \quad \text{and} \quad N_q(a) = -1/u \quad \text{for } r \leq u,$$

where $u = \omega T$, $r = a/V$ and $\cos \alpha = 1 - (2u/r)$.

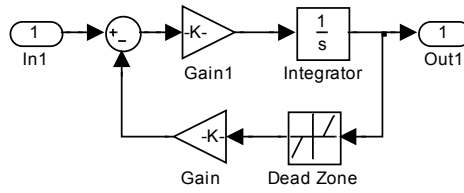

Figure P9.5 Simulink diagram of limited integrator

Problem 9.6

The block diagram of a SPAN filter is shown in Figure P9.6. Show that its DF, $N(a)$, is $(2/\pi)\{\tan^{-1}(1/\alpha) + \alpha/(1+\alpha^2) + j\alpha^2/(1+\alpha^2)\}$ where $\alpha = \omega T$.

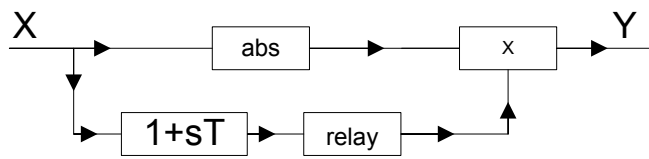

Figure P9.6 Block diagram of SPAN filter.

Problem 9.7

A driven limiter is described by the equations

$$n(x, \dot{x}) = x \operatorname{sgn}(x + T\dot{x}) \text{ for } |x| < |x + T\dot{x}|$$

$$n(x, \dot{x}) = x + T\dot{x} \text{ for } |x| > |x + T\dot{x}|$$

Show that its DF is $2 \tan^{-1}(2\pi/\alpha) + j\alpha \tan^{-1}(2\pi/\alpha)$ where $\alpha = \omega T$.

Problem 9.8

A nonlinear feedback loop with unit negative feedback and a zero reference input has an ideal relay, with output levels of ± 1 , followed by transfer functions $G_1(s)$ and $G_2(s)$ in the forward path. A constant disturbance U enters the forward path after $G_1(s)$. Find using the DF method the limit cycle frequency and amplitude at the relay input, and the relay output on off ratio, ρ , if $U = 0, -2$ and -4 , respectively, $G_1(s) = \frac{10}{s+1}$ and $G_2(s) = \frac{1}{s(s+2)}$.

	Calculated	Calculated	Calculated	Measured	Measured	Measured
U	ω	a	ρ	ω	Peak amp.	ρ
0	1.414	2.122	1.00	1.37	2.20	1.00
-2	1.414	2.018	1.50	1.36	2.18	1.50
-4	1.414	1.717	2.33	1.29	2.10	2.29

Problem 9.9

Use the DF method to estimate the limit cycle in Example 8.12

[Amplitude for both x and v of $2b/\sqrt{3}$, period 2π .]

Problem 9.10

Figure P9.10 shows a simple feedback system. If G_1 is a gain K , $G_2 = 1/(1+s)^2$ and NL is an ideal saturation characteristic with unit slope in the linear regime and saturating at unit input, estimate using the DF the maximum allowable gain K if the system is to remain stable for initial conditions up to a magnitude of 3 on the output C . Check the result by simulation.

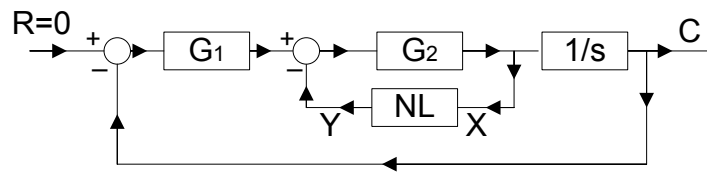

Figure P9.10 Block diagram of feedback loop.

[3.44; simulation 2.85]

Problem 9.11

A negative feedback loop contains an ideal relay with output ± 1 and an FOPDT (first order plus dead time) plant with transfer function $Ke^{-\rho s}/(1+s)$. [Note this is the normalised version of the plant $Ke^{-s\tau}/(1+sT)$]. Determine the limit cycle frequency given by the DF method and also the exact value. Calculate also the result given for the limit cycle amplitude by the DF method and the exact peak amplitude.

[Using the DF the solution for ω_c is given by $\rho\omega_c + \tan^{-1} \omega_c = \pi$ and the amplitude by $4K/\pi(1+\omega_c^2)^{1/2}$; the exact solution is $\omega_o = \pi/\log(2e^\rho - 1)$ and the peak amplitude is $K(1 - e^{-\rho})$]

Problem 9.12

A negative feedback loop contains an ideal relay with output ± 1 and a plant with the transfer function $Ke^{-\rho s}/s$. Show that the DF method gives the exact frequency $\pi/2\rho$ of the limit cycle and that the amplitude predicted is the fundamental amplitude of the actual limit cycle waveform. What does this suggest about how better results for estimating the critical gain might be obtained for the plant of Problem 9.11 in the autotuning method.

[Better estimates for K_c from the relay test can be obtained by estimating the fundamental of the amplitude – approximately triangular waveform for small ρ and square waveform for large ρ for the FOPDT plant – and using this value of amplitude in the DF expression giving K_c .]

Problem 9.13

Determine in terms of T the frequency of the limit cycle in a negative feedback loop containing an ideal relay and a plant with the transfer function $G(s) = K / s(1 + s)(1 + sT)$ using both (a) the DF method and (b) the exact method of Tsytkin. (Note this is the normalised version of the plant $G(s) = K_1 / s(1 + sT_1)(1 + sT_2)$). Give the values for $T = 2$. Check the Tsytkin solution by using the state space solution given in Example 9.16 for a state space representation of the transfer function $G(s) = K / (s + \varepsilon)(1 + s)(1 + sT)$ with ε small.

$$[\text{(a) } \omega = 1/\sqrt{T} \quad \text{(b) } \{(T-1)\pi/2\omega\} + \tanh(\pi/2\omega) - T^2 \tanh(\pi/2\omega T) \quad \text{(a) } 0.7070 \quad \text{(b) } 0.6903]$$

Problem 9.14

Use the state space method to estimate the limit cycle frequency for a negative feedback loop containing a relay with hysteresis having $h/\Delta = 2$ and the transfer function $G(s) = 1/(1 + s)^3$.

$$[0.8251 \text{ rads/s. using } \varepsilon = 0.01 \text{ (see Example 9.14)}]$$

Problem 9.15

Use the state space method to determine the half period of the odd symmetrical limit cycle in a negative feedback system containing a relay with hysteresis, having $h/\Delta = 2$, a delay of 0.5 and a transfer function of $G(s) = 1/(1 + s)(1 + 2s)(1 + 4s)$.

$$[5.2803]$$

Problem 9.16

Show that in a negative feedback loop with an ideal relay the normalised unstable FOPDT (first order plus dead time) plant, $G(s) = Ke^{-s\theta} / (s - 1)$, will only possess a limit cycle for $\theta < 0.693$.

Problem 9.17

Derive using the state space method the equations which yield the solution for the pulse width τ and half period T of the odd symmetrical limit cycle in a negative feedback loop containing a relay with dead zone and hysteresis and the plant $(A, B, C, 0)$.

$$[x(t_0) = (I + e^{AT})^{-1} A^{-1} (e^{AT} - e^{A(T-\tau)}) Bh, \quad x(t_1) = e^{A\tau} x(t_0) - A^{-1} (e^{A\tau} - I) Bh, \quad Cx(t_0) = \delta + \Delta \\ \text{and } Cx(t_1) = \delta - \Delta.]$$

Problem 9.18

Obtain the limit cycle half period and pulse width using the state space method for the case of Problem 9.17 if $G(s) = 24/(1+s)(1+2s)(1+4s)$, $h = 1$, $\delta = 1$ and $\Delta = 0.5$.

[3.8412 and 3.1322 for the stable limit cycle; 10.2498 and 1.2995 for the unstable one.]

SIMPLY CLEVER

ŠKODA



WE WILL TURN YOUR CV INTO AN OPPORTUNITY OF A LIFETIME



Do you like cars? Would you like to be a part of a successful brand?
As a constructor at ŠKODA AUTO you will put great things in motion. Things that will ease everyday lives of people all around Send us your CV. We will give it an entirely new new dimension.

Send us your CV on www.employerforlife.com