

# Basics of Fluid Mechanics

Genick Bar–Meir, Ph. D.  
7449 North Washtenaw Ave  
Chicago, IL 60645  
email:genick at potto.org

Copyright © 2013, 2011, 2010, 2009, 2008, 2007, and 2006 by Genick Bar-Meir  
See the file copying.fdl or copyright.tex for copying conditions.

Version (0.3.4.0 July 25, 2013)

## HOW TO CITE THIS BOOK:

Bar-Meir, Genick, "Basics of Fluid Mechanics", {last modified or Accessed}: **insert the date and version you are using**, [www.potto.org/downloads.php](http://www.potto.org/downloads.php)

### EXAMPLE:

#### **If you are using the latest version**

Bar-Meir, Genick, "Basics of Fluid Mechanics", Last modified: Version 0.3.4.0 March 17, 2013, [www.potto.org/downloads.php](http://www.potto.org/downloads.php)

#### **If you are using older version**

Bar-Meir, Genick, "Basics of Fluid Mechanics", Accessed: Version 0.3.0.0 Nov 17, 2010, [www.potto.org/downloads.php](http://www.potto.org/downloads.php)

‘We are like dwarfs sitting on the shoulders of giants’

from *The Metalogicon* by John in 1159



---

# CONTENTS

<b>Nomenclature</b>	<b>xxiii</b>
GNU Free Documentation License . . . . .	xxxiii
1. APPLICABILITY AND DEFINITIONS . . . . .	xxxiv
2. VERBATIM COPYING . . . . .	xxxv
3. COPYING IN QUANTITY . . . . .	xxxv
4. MODIFICATIONS . . . . .	xxxvi
5. COMBINING DOCUMENTS . . . . .	xxxviii
6. COLLECTIONS OF DOCUMENTS . . . . .	xxxviii
7. AGGREGATION WITH INDEPENDENT WORKS . . . . .	xxxix
8. TRANSLATION . . . . .	xxxix
9. TERMINATION . . . . .	xxxix
10. FUTURE REVISIONS OF THIS LICENSE . . . . .	xxxix
ADDENDUM: How to use this License for your documents . . . . .	xl
How to contribute to this book . . . . .	xli
Credits . . . . .	xli
Steven from <a href="http://artofproblemsolving.com">artofproblemsolving.com</a> . . . . .	xli
Dan H. Olson . . . . .	xlii
Richard Hackbarth . . . . .	xlii
John Herbolenes . . . . .	xlii
Eliezer Bar-Meir . . . . .	xlii
Henry Schoumertate . . . . .	xlii
Your name here . . . . .	xlii
Typo corrections and other "minor" contributions . . . . .	xliii
Version 0.3.2.0 March 18, 2013 . . . . .	liii
pages 617 size 4.8M . . . . .	liii
Version 0.3.0.5 March 1, 2011 . . . . .	liii

pages 400 size 3.5M . . . . .	liii
Version 0.1.8 August 6, 2008 . . . . .	liv
pages 189 size 2.6M . . . . .	liv
Version 0.1 April 22, 2008 . . . . .	liv
pages 151 size 1.3M . . . . .	liv
Properties . . . . .	lxi
Open Channel Flow . . . . .	lxi
<b>1 Introduction to Fluid Mechanics</b>	<b>1</b>
1.1 What is Fluid Mechanics? . . . . .	1
1.2 Brief History . . . . .	3
1.3 Kinds of Fluids . . . . .	5
1.4 Shear Stress . . . . .	6
1.5 ViscosityViscosity . . . . .	9
1.5.1 General . . . . .	9
1.5.2 Non-Newtonian Fluids . . . . .	10
1.5.3 Kinematic Viscosity . . . . .	11
1.5.4 Estimation of The Viscosity . . . . .	12
1.6 Fluid Properties . . . . .	21
1.6.1 Fluid Density . . . . .	22
1.6.2 Bulk Modulus . . . . .	24
1.7 Surface Tension . . . . .	30
1.7.1 Wetting of Surfaces . . . . .	35
<b>2 Review of Thermodynamics</b>	<b>45</b>
2.1 Basic Definitions . . . . .	45
<b>3 Review of Mechanics</b>	<b>53</b>
3.1 Kinematics of of Point Body . . . . .	53
3.2 Center of Mass . . . . .	55
3.2.1 Actual Center of Mass . . . . .	55
3.2.2 Aproximate Center of Area . . . . .	56
3.3 Moment of Inertia . . . . .	56
3.3.1 Moment of Inertia for Mass . . . . .	56
3.3.2 Moment of Inertia for Area . . . . .	57
3.3.3 Examples of Moment of Inertia . . . . .	59
3.3.4 Product of Inertia . . . . .	63
3.3.5 Principal Axes of Inertia . . . . .	64
3.4 Newton's Laws of Motion . . . . .	64
3.5 Angular Momentum and Torque . . . . .	65
3.5.1 Tables of geometries . . . . .	66

<b>4</b>	<b>Fluids Statics</b>	<b>69</b>
4.1	Introduction . . . . .	69
4.2	The Hydrostatic Equation . . . . .	69
4.3	Pressure and Density in a Gravitational Field . . . . .	71
4.3.1	Constant Density in Gravitational Field . . . . .	71
4.3.2	Pressure Measurement . . . . .	75
4.3.3	Varying Density in a Gravity Field . . . . .	79
4.3.4	The Pressure Effects Due To Temperature Variations . . . . .	86
4.3.5	Gravity Variations Effects on Pressure and Density . . . . .	90
4.3.6	Liquid Phase . . . . .	92
4.4	Fluid in a Accelerated System . . . . .	93
4.4.1	Fluid in a Linearly Accelerated System . . . . .	93
4.4.2	Angular Acceleration Systems: Constant Density . . . . .	95
4.4.3	Fluid Statics in Geological System . . . . .	97
4.5	Fluid Forces on Surfaces . . . . .	100
4.5.1	Fluid Forces on Straight Surfaces . . . . .	100
4.5.2	Forces on Curved Surfaces . . . . .	109
4.6	Buoyancy and Stability . . . . .	117
4.6.1	Stability . . . . .	126
4.6.2	Surface Tension . . . . .	138
4.7	Rayleigh–Taylor Instability . . . . .	139
4.8	Qualitative questions . . . . .	143
<b>I</b>	<b>Integral Analysis</b>	<b>145</b>
<b>5</b>	<b>Mass Conservation</b>	<b>147</b>
5.1	Introduction . . . . .	147
5.2	Control Volume . . . . .	148
5.3	Continuity Equation . . . . .	149
5.3.1	Non Deformable Control Volume . . . . .	151
5.3.2	Constant Density Fluids . . . . .	151
5.4	Reynolds Transport Theorem . . . . .	158
5.5	Examples For Mass Conservation . . . . .	160
5.6	The Details Picture – Velocity Area Relationship . . . . .	166
5.7	More Examples for Mass Conservation . . . . .	169
<b>6</b>	<b>Momentum Conservation</b>	<b>173</b>
6.1	Momentum Governing Equation . . . . .	173
6.1.1	Introduction to Continuous . . . . .	173
6.1.2	External Forces . . . . .	174
6.1.3	Momentum Governing Equation . . . . .	175
6.1.4	Momentum Equation in Acceleration System . . . . .	175
6.1.5	Momentum For Steady State and Uniform Flow . . . . .	176
6.2	Momentum Equation Application . . . . .	180

6.2.1	Momentum for Unsteady State and Uniform Flow . . . . .	183
6.2.2	Momentum Application to Unsteady State . . . . .	183
6.3	Conservation Moment Of Momentum . . . . .	190
6.4	More Examples on Momentum Conservation . . . . .	192
6.4.1	Qualitative Questions . . . . .	194
<b>7</b>	<b>Energy Conservation</b>	<b>197</b>
7.1	The First Law of Thermodynamics . . . . .	197
7.2	Limitation of Integral Approach . . . . .	209
7.3	Approximation of Energy Equation . . . . .	211
7.3.1	Energy Equation in Steady State . . . . .	211
7.3.2	Energy Equation in Frictionless Flow and Steady State . . . . .	212
7.4	Energy Equation in Accelerated System . . . . .	213
7.4.1	Energy in Linear Acceleration Coordinate . . . . .	213
7.4.2	Linear Accelerated System . . . . .	214
7.4.3	Energy Equation in Rotating Coordinate System . . . . .	215
7.4.4	Simplified Energy Equation in Accelerated Coordinate . . . . .	216
7.4.5	Energy Losses in Incompressible Flow . . . . .	216
7.5	Examples of Integral Energy Conservation . . . . .	218
<b>II</b>	<b>Differential Analysis</b>	<b>225</b>
<b>8</b>	<b>Differential Analysis</b>	<b>227</b>
8.1	Introduction . . . . .	227
8.2	Mass Conservation . . . . .	228
8.2.1	Mass Conservation Examples . . . . .	231
8.2.2	Simplified Continuity Equation . . . . .	233
8.3	Conservation of General Quantity . . . . .	238
8.3.1	Generalization of Mathematical Approach for Derivations . . . . .	238
8.3.2	Examples of Several Quantities . . . . .	239
8.4	Momentum Conservation . . . . .	241
8.5	Derivations of the Momentum Equation . . . . .	244
8.6	Boundary Conditions and Driving Forces . . . . .	255
8.6.1	Boundary Conditions Categories . . . . .	255
8.7	Examples for Differential Equation (Navier-Stokes) . . . . .	259
8.7.1	Interfacial Instability . . . . .	269
<b>9</b>	<b>Dimensional Analysis</b>	<b>273</b>
9.1	Introductory Remarks . . . . .	273
9.1.1	Brief History . . . . .	274
9.1.2	Theory Behind Dimensional Analysis . . . . .	275
9.1.3	Dimensional Parameters Application for Experimental Study . . . . .	277
9.1.4	The Pendulum Class Problem . . . . .	278
9.2	Buckingham- $\pi$ -Theorem . . . . .	280



9.2.1	Construction of the Dimensionless Parameters . . . . .	281
9.2.2	Basic Units Blocks . . . . .	282
9.2.3	Implementation of Construction of Dimensionless Parameters . . . . .	285
9.2.4	Similarity and Similitude . . . . .	294
9.3	Nusselt's Technique . . . . .	298
9.4	Summary of Dimensionless Numbers . . . . .	308
9.4.1	The Significance of these Dimensionless Numbers . . . . .	312
9.4.2	Relationship Between Dimensionless Numbers . . . . .	315
9.4.3	Examples for Dimensional Analysis . . . . .	316
9.5	Summary . . . . .	319
9.6	Appendix summary of Dimensionless Form of Navier–Stokes Equations . . . . .	319
<b>10</b>	<b>Potential Flow</b>	<b>325</b>
10.1	Introduction . . . . .	325
10.1.1	Inviscid Momentum Equations . . . . .	326
10.2	Potential Flow Function . . . . .	332
10.2.1	Streamline and Stream function . . . . .	333
10.2.2	Compressible Flow Stream Function . . . . .	336
10.2.3	The Connection Between the Stream Function and the Potential Function	338
10.3	Potential Flow Functions Inventory . . . . .	342
10.3.1	Flow Around a Circular Cylinder . . . . .	357
10.4	Conforming Mapping . . . . .	369
10.4.1	Complex Potential and Complex Velocity . . . . .	369
10.5	Unsteady State Bernoulli in Accelerated Coordinates . . . . .	373
10.6	Questions . . . . .	373
<b>11</b>	<b>Compressible Flow One Dimensional</b>	<b>377</b>
11.1	What is Compressible Flow? . . . . .	377
11.2	Why Compressible Flow is Important? . . . . .	377
11.3	Speed of Sound . . . . .	378
11.3.1	Introduction . . . . .	378
11.3.2	Speed of Sound in Ideal and Perfect Gases . . . . .	380
11.3.3	Speed of Sound in Almost Incompressible Liquid . . . . .	381
11.3.4	Speed of Sound in Solids . . . . .	382
11.3.5	The Dimensional Effect of the Speed of Sound . . . . .	382
11.4	Iisentropic Flow . . . . .	384
11.4.1	Stagnation State for Ideal Gas Model . . . . .	384
11.4.2	Iisentropic Converging-Diverging Flow in Cross Section . . . . .	386
11.4.3	The Properties in the Adiabatic Nozzle . . . . .	387
11.4.4	Iisentropic Flow Examples . . . . .	391
11.4.5	Mass Flow Rate (Number) . . . . .	394
11.4.6	Iisentropic Tables . . . . .	401
11.4.7	The Impulse Function . . . . .	403
11.5	Normal Shock . . . . .	406
11.5.1	Solution of the Governing Equations . . . . .	408

11.5.2	Prandtl's Condition . . . . .	411
11.5.3	Operating Equations and Analysis . . . . .	413
11.5.4	The Moving Shocks . . . . .	414
11.5.5	Shock or Wave Drag Result from a Moving Shock . . . . .	416
11.5.6	Tables of Normal Shocks, $k = 1.4$ Ideal Gas . . . . .	418
11.6	Isothermal Flow . . . . .	421
11.6.1	The Control Volume Analysis/Governing equations . . . . .	421
11.6.2	Dimensionless Representation . . . . .	422
11.6.3	The Entrance Limitation of Supersonic Branch . . . . .	426
11.6.4	Supersonic Branch . . . . .	428
11.6.5	Figures and Tables . . . . .	429
11.6.6	Isothermal Flow Examples . . . . .	430
11.7	Fanno Flow . . . . .	436
11.7.1	Introduction . . . . .	436
11.7.2	Non-Dimensionalization of the Equations . . . . .	438
11.7.3	The Mechanics and Why the Flow is Choked? . . . . .	441
11.7.4	The Working Equations . . . . .	442
11.7.5	Examples of Fanno Flow . . . . .	445
11.7.6	Working Conditions . . . . .	451
11.7.7	The Pressure Ratio, $P_2/P_1$ , effects . . . . .	456
11.7.8	Practical Examples for Subsonic Flow . . . . .	463
11.7.9	Subsonic Fanno Flow for Given $\frac{4fL}{D}$ and Pressure Ratio . . . . .	463
11.7.10	Subsonic Fanno Flow for a Given $M_1$ and Pressure Ratio . . . . .	466
11.7.11	More Examples of Fanno Flow . . . . .	468
11.8	The Table for Fanno Flow . . . . .	469
11.9	Rayleigh Flow . . . . .	471
11.10	Introduction . . . . .	471
11.10.1	Governing Equations . . . . .	472
11.10.2	Rayleigh Flow Tables and Figures . . . . .	475
11.10.3	Examples For Rayleigh Flow . . . . .	478
<b>12</b>	<b>Compressible Flow 2-Dimensional</b>	<b>485</b>
12.1	Introduction . . . . .	485
12.1.1	Preface to Oblique Shock . . . . .	485
12.2	Oblique Shock . . . . .	487
12.2.1	Solution of Mach Angle . . . . .	489
12.2.2	When No Oblique Shock Exist or the case of $D > 0$ . . . . .	492
12.2.3	Application of Oblique Shock . . . . .	508
12.3	Prandtl-Meyer Function . . . . .	520
12.3.1	Introduction . . . . .	520
12.3.2	Geometrical Explanation . . . . .	521
12.3.3	Alternative Approach to Governing Equations . . . . .	522
12.3.4	Comparison And Limitations between the Two Approaches . . . . .	525
12.4	The Maximum Turning Angle . . . . .	526

12.5	The Working Equations for the Prandtl-Meyer Function . . . . .	526
12.6	d'Alembert's Paradox . . . . .	526
12.7	Flat Body with an Angle of Attack . . . . .	527
12.8	Examples For Prandtl-Meyer Function . . . . .	527
12.9	Combination of the Oblique Shock and Isentropic Expansion . . . . .	530
<b>13</b>	<b>Multi-Phase Flow</b>	<b>535</b>
13.1	Introduction . . . . .	535
13.2	History . . . . .	535
13.3	What to Expect From This Chapter . . . . .	536
13.4	Kind of Multi-Phase Flow . . . . .	537
13.5	Classification of Liquid-Liquid Flow Regimes . . . . .	538
13.5.1	Co-Current Flow . . . . .	539
13.6	Multi-Phase Flow Variables Definitions . . . . .	543
13.6.1	Multi-Phase Averaged Variables Definitions . . . . .	544
13.7	Homogeneous Models . . . . .	547
13.7.1	Pressure Loss Components . . . . .	548
13.7.2	Lockhart Martinelli Model . . . . .	550
13.8	Solid-Liquid Flow . . . . .	551
13.8.1	Solid Particles with Heavier Density $\rho_S > \rho_L$ . . . . .	552
13.8.2	Solid With Lighter Density $\rho_S < \rho$ and With Gravity . . . . .	554
13.9	Counter-Current Flow . . . . .	555
13.9.1	Horizontal Counter-Current Flow . . . . .	557
13.9.2	Flooding and Reversal Flow . . . . .	558
13.10	Multi-Phase Conclusion . . . . .	565
<b>A</b>	<b>Mathematics For Fluid Mechanics</b>	<b>567</b>
A.1	Vectors . . . . .	567
A.1.1	Vector Algebra . . . . .	568
A.1.2	Differential Operators of Vectors . . . . .	570
A.1.3	Differentiation of the Vector Operations . . . . .	572
A.2	Ordinary Differential Equations (ODE) . . . . .	578
A.2.1	First Order Differential Equations . . . . .	578
A.2.2	Variables Separation or Segregation . . . . .	579
A.2.3	Non-Linear Equations . . . . .	581
A.2.4	Second Order Differential Equations . . . . .	584
A.2.5	Non-Linear Second Order Equations . . . . .	586
A.2.6	Third Order Differential Equation . . . . .	589
A.2.7	Forth and Higher Order ODE . . . . .	591
A.2.8	A general Form of the Homogeneous Equation . . . . .	593
A.3	Partial Differential Equations . . . . .	593
A.3.1	First-order equations . . . . .	594
A.4	Trigonometry . . . . .	595

<b>Index</b>	<b>597</b>
Subjects Index . . . . .	597
Authors Index . . . . .	603

---

# LIST OF FIGURES

1.1	Diagram to explain fluid mechanics branches . . . . .	2
1.2	Density as a function of the size of sample . . . . .	6
1.3	Schematics to describe the shear stress in fluid mechanics . . . . .	6
1.4	The deformation of fluid due to shear stress . . . . .	7
1.5	The difference of power fluids . . . . .	9
1.6	Nitrogen and Argon viscosity. . . . .	10
1.7	The shear stress as a function of the shear rate . . . . .	10
1.8	Air viscosity as a function of the temperature . . . . .	11
1.9	Water viscosity as a function temperature. . . . .	12
1.10	Liquid metals viscosity as a function of the temperature . . . . .	13
1.11	Reduced viscosity as function of the reduced temperature . . . . .	17
1.12	Reduced viscosity as function of the reduced temperature . . . . .	18
1.13	Concentrating cylinders with the rotating inner cylinder . . . . .	20
1.14	Rotating disc in a steady state . . . . .	21
1.15	Water density as a function of temperature . . . . .	22
1.16	Two liquid layers under pressure . . . . .	27
1.17	Surface tension control volume analysis . . . . .	30
1.18	Surface tension erroneous explanation . . . . .	31
1.19	Glass tube inserted into mercury . . . . .	32
1.20	Capillary rise between two plates . . . . .	34
1.21	Forces in Contact angle . . . . .	35
1.22	Description of wetting and non-wetting fluids . . . . .	35
1.23	Description of the liquid surface . . . . .	37
1.24	The raising height as a function of the radii . . . . .	40
1.25	The raising height as a function of the radius . . . . .	40
3.1	Description of the extinguish nozzle . . . . .	54

3.2	Description of how the center of mass is calculated . . . . .	55
3.3	Thin body center of mass/area schematic. . . . .	56
3.4	The schematic that explains the summation of moment of inertia. . . . .	57
3.5	The schematic to explain the summation of moment of inertia. . . . .	58
3.6	Cylinder with an element for calculation moment of inertia . . . . .	59
3.7	Description of rectangular in $x$ - $y$ plane. . . . .	59
3.8	A square element for the calculations of inertia. . . . .	60
3.9	The ratio of the moment of inertia 2D to 3D. . . . .	60
3.10	Moment of inertia for rectangular . . . . .	61
3.11	Description of parabola - moment of inertia and center of area . . . . .	61
3.12	Triangle for example 3.7 . . . . .	62
3.13	Product of inertia for triangle . . . . .	64
4.1	Description of a fluid element in accelerated system. . . . .	69
4.2	Pressure lines in a static constant density fluid . . . . .	71
4.3	A schematic to explain the atmospheric pressure measurement . . . . .	72
4.4	The effective gravity is for accelerated cart . . . . .	73
4.5	Tank and the effects different liquids . . . . .	74
4.6	Schematic of gas measurement utilizing the "U" tube . . . . .	76
4.7	Schematic of sensitive measurement device . . . . .	77
4.8	Inclined manometer . . . . .	78
4.9	Inverted manometer . . . . .	79
4.10	Hydrostatic pressure under a compressible liquid phase . . . . .	82
4.11	Two adjoin layers for stability analysis . . . . .	88
4.12	The varying gravity effects on density and pressure . . . . .	90
4.13	The effective gravity is for accelerated cart . . . . .	93
4.14	A cart slide on inclined plane . . . . .	94
4.15	Forces diagram of cart sliding on inclined plane . . . . .	95
4.16	Schematic to explain the angular angle . . . . .	95
4.17	Schematic angular angle to explain example 4.11 . . . . .	96
4.18	Earth layers not to scale . . . . .	97
4.19	Illustration of the effects of the different radii . . . . .	98
4.20	Rectangular area under pressure . . . . .	100
4.21	Schematic of submerged area . . . . .	101
4.22	The general forces acting on submerged area . . . . .	102
4.23	The general forces acting on non symmetrical straight area . . . . .	104
4.24	The general forces acting on a non symmetrical straight area . . . . .	105
4.25	The effects of multi layers density on static forces . . . . .	108
4.26	The forces on curved area . . . . .	109
4.27	Schematic of Net Force on floating body . . . . .	110
4.28	Circular shape Dam . . . . .	111
4.29	Area above the dam arc subtract triangle . . . . .	112
4.30	Area above the dam arc calculation for the center . . . . .	113
4.31	Moment on arc element around Point "O" . . . . .	113

4.32	Polynomial shape dam description . . . . .	115
4.33	The difference between the slop and the direction angle . . . . .	115
4.34	Schematic of Immersed Cylinder . . . . .	117
4.35	The floating forces on Immersed Cylinder . . . . .	118
4.36	Schematic of a thin wall floating body . . . . .	118
4.37	Schematic of floating bodies . . . . .	126
4.38	Schematic of floating cubic . . . . .	127
4.39	Stability analysis of floating body . . . . .	127
4.40	Cubic body dimensions for stability analysis . . . . .	130
4.41	Stability of cubic body infinity long . . . . .	131
4.42	The maximum height reverse as a function of density ratio . . . . .	131
4.43	Stability of two triangles put together . . . . .	132
4.44	The effects of liquid movement on the $\overline{GM}$ . . . . .	134
4.45	Measurement of $\overline{GM}$ of floating body . . . . .	135
4.46	Calculations of $\overline{GM}$ for abrupt shape body . . . . .	136
4.47	A heavy needle is floating on a liquid. . . . .	138
4.48	Description of depression to explain the Rayleigh–Taylor instability . . . . .	139
4.49	Description of depression to explain the instability . . . . .	141
4.50	The cross section of the interface for max liquid. . . . .	142
4.51	Three liquids layers under rotation . . . . .	143
5.1	Control volume and system in motion . . . . .	147
5.2	Piston control volume . . . . .	148
5.3	Schematics of velocities at the interface . . . . .	149
5.4	Schematics of flow in a pipe with varying density . . . . .	150
5.5	Filling of the bucket and choices of the control volumes . . . . .	153
5.6	Height of the liquid for example 5.4 . . . . .	156
5.7	Boundary Layer control mass . . . . .	161
5.8	Control volume usage to calculate local averaged velocity . . . . .	166
5.9	Control volume and system in the motion . . . . .	167
5.10	Circular cross section for finding $U_x$ . . . . .	168
5.11	Velocity for a circular shape . . . . .	169
5.12	Boat for example 5.14 . . . . .	169
6.1	The explanation for the direction relative to surface . . . . .	174
6.2	Schematics of area impinged by a jet . . . . .	177
6.3	Nozzle schematic for forces calculations . . . . .	179
6.4	Propeller schematic to explain the change of momentum . . . . .	181
6.5	Toy Sled pushed by the liquid jet . . . . .	182
6.6	A rocket with a moving control volume . . . . .	183
6.7	Schematic of a tank seating on wheels . . . . .	185
6.8	A new control volume to find the velocity in discharge tank . . . . .	186
6.9	The impeller of the centrifugal pump and the velocities diagram . . . . .	191
6.10	Nozzle schematics water rocket . . . . .	192
6.11	Flow out of un symmetrical tank . . . . .	195

6.12	The explanation for the direction relative to surface . . . . .	196
7.1	The work on the control volume . . . . .	198
7.2	Discharge from a Large Container . . . . .	200
7.3	Kinetic Energy and Averaged Velocity . . . . .	202
7.4	Typical resistance for selected outlet configuration . . . . .	210
	(a) Projecting pipe $K=1$ . . . . .	210
	(b) Sharp edge pipe connection $K=0.5$ . . . . .	210
	(c) Rounded inlet pipe $K=0.04$ . . . . .	210
7.5	Flow in an oscillating manometer . . . . .	210
7.6	A long pipe exposed to a sudden pressure difference . . . . .	218
7.7	Liquid exiting a large tank trough a long tube . . . . .	220
7.8	Tank control volume for Example 7.2 . . . . .	221
8.1	The mass balance on the infinitesimal control volume . . . . .	228
8.2	The mass conservation in cylindrical coordinates . . . . .	230
8.3	Mass flow due to temperature difference . . . . .	232
8.4	Mass flow in coating process . . . . .	234
8.5	Stress diagram on a tetrahedron shape . . . . .	241
8.6	Diagram to analysis the shear stress tensor . . . . .	243
8.7	The shear stress creating torque . . . . .	243
8.8	The shear stress at different surfaces . . . . .	245
8.9	Control volume at $t$ and $t + dt$ under continuous angle deformation . . . . .	247
8.10	Shear stress at two coordinates in $45^\circ$ orientations . . . . .	248
8.11	Different rectangles deformations . . . . .	249
	(a) Deformations of the isosceles triangular . . . . .	249
	(b) Deformations of the straight angle triangle . . . . .	249
8.12	Linear strain of the element . . . . .	251
8.13	1-Dimensional free surface . . . . .	256
8.14	Flow driven by surface tension . . . . .	259
8.15	Flow in kandle with a surfcece tension gradient . . . . .	259
8.16	Flow between two plates when the top moving . . . . .	260
8.17	One dimensional flow with shear between plates . . . . .	261
8.18	The control volume of liquid element in "short cut" . . . . .	262
8.19	Flow of Liquid between concentric cylinders . . . . .	264
8.20	Mass flow due to temperature difference . . . . .	267
8.21	Liquid flow due to gravity . . . . .	269
9.1	Fitting rod into a hole . . . . .	278
9.2	Pendulum for dimensional analysis . . . . .	279
9.3	Resistance of infinite cylinder . . . . .	285
9.4	Oscillating Von Karman Vortex Street . . . . .	312
10.1	Streamlines to explain stream function . . . . .	334
10.2	Streamlines with different different element direction to explain stream function	335



(a) Streamlines with element in X direction to explain stream function 335  
 (b) Streamlines with element in the Y direction to explain stream function 335

10.3 Constant Stream lines and Constant Potential lines . . . . . 339

10.4 Stream lines and potential lines are drawn as drawn for two dimensional flow. 340

10.5 Stream lines and potential lines for Example 10.3 . . . . . 341

10.6 Uniform Flow Streamlines and Potential Lines . . . . . 343

10.7 Streamlines and Potential lines due to Source or sink . . . . . 344

10.8 Vortex free flow . . . . . 345

10.9 Circulation path to illustrate varies calculations . . . . . 347

10.10 Combination of the Source and Sink . . . . . 350

10.11 Stream and Potential line for a source and sink . . . . . 352

10.12 Stream and potential lines for doublet . . . . . 358

10.13 Stream function of uniform flow plus doublet . . . . . 360

10.14 Source in the Uniform Flow . . . . . 361

10.15 Velocity field around a doublet in uniform velocity . . . . . 362

10.16 Doublet in a uniform flow with Vortex in various conditions. . . . . 366  
 (a) Streamlines of doublet in uniform field with Vortex . . . . . 366  
 (b) Boundary case for streamlines of doublet in uniform field with Vortex 366

10.17 Schematic to explain Magnus's effect . . . . . 368

10.18 Wing in a typical uniform flow . . . . . 368

11.1 A very slow moving piston in a still gas . . . . . 378

11.2 Stationary sound wave and gas moves relative to the pulse . . . . . 378

11.3 Moving object at three relative velocities . . . . . 383  
 (a) Object travels at 0.005 of the speed of sound . . . . . 383  
 (b) Object travels at 0.05 of the speed of sound . . . . . 383  
 (c) Object travels at 0.15 of the speed of sound . . . . . 383

11.4 Flow through a converging diverging nozzle . . . . . 384

11.5 Perfect gas flows through a tube . . . . . 385

11.7 Control volume inside a converging-diverging nozzle. . . . . 386

11.6 Station properties as  $f(M)$  . . . . . 387

11.8 The relationship between the cross section and the Mach number . . . . 391

11.9 Schematic to explain the significances of the Impulse function . . . . . 403

11.10 Schematic of a flow through a nozzle example (??) . . . . . 405

11.11 A shock wave inside a tube . . . . . 406

11.12 The  $M_{exit}$  and  $P_0$  as a function  $M_{upstream}$  . . . . . 412

11.13 The ratios of the static properties of the two sides of the shock. . . . . 413

11.14 Stationary and moving coordinates for the moving shock . . . . . 415  
 (a) Stationary coordinates . . . . . 415  
 (b) Moving coordinates . . . . . 415

11.15 The shock drag diagram for moving shock . . . . . 416

11.16 The diagram for the common explanation for shock drag . . . . . 417

11.17 Control volume for isothermal flow . . . . . 421

11.18 Working relationships for isothermal flow . . . . . 427

11.19	Control volume of the gas flow in a constant cross section for Fanno Flow	436
11.20	Various parameters in fanno flow . . . . .	445
11.21	Schematic of Example 11.18 . . . . .	445
11.22	The schematic of Example (11.19) . . . . .	447
11.23	The effects of increase of $\frac{4fL}{D}$ on the Fanno line . . . . .	451
11.24	The effects of the increase of $\frac{4fL}{D}$ on the Fanno Line . . . . .	452
11.25	$M_{in}$ and $\dot{m}$ as a function of the $\frac{4fL}{D}$ . . . . .	452
11.26	$M_1$ as a function $M_2$ for various $\frac{4fL}{D}$ . . . . .	454
11.27	$M_1$ as a function $M_2$ . . . . .	455
11.28	The pressure distribution as a function of $\frac{4fL}{D}$ . . . . .	456
11.29	Pressure as a function of long $\frac{4fL}{D}$ . . . . .	457
11.30	The effects of pressure variations on Mach number profile . . . . .	458
11.31	Pressure ratios as a function of $\frac{4fL}{D}$ when the total $\frac{4fL}{D} = 0.3$ . . . . .	459
11.32	The maximum entrance Mach number as a function of $\frac{4fL}{D}$ . . . . .	460
11.33	Unchoked flow showing the hypothetical "full" tube . . . . .	463
11.34	Pressure ratio obtained for fix $\frac{4fL}{D}$ for $k=1.4$ . . . . .	464
11.35	Conversion of solution for given $\frac{4fL}{D} = 0.5$ and pressure ratio . . . . .	465
11.36	The results of the algorithm showing the conversion rate . . . . .	467
11.37	The control volume of Rayleigh Flow . . . . .	471
11.38	The temperature entropy diagram for Rayleigh line . . . . .	473
11.39	The basic functions of Rayleigh Flow ( $k=1.4$ ) . . . . .	478
11.40	Schematic of the combustion chamber . . . . .	483
12.1	A view of a normal shock as a limited case for oblique shock . . . . .	485
12.2	The oblique shock or Prandtl–Meyer function regions . . . . .	486
12.3	A typical oblique shock schematic . . . . .	486
12.4	Flow around spherically blunted $30^\circ$ cone-cylinder . . . . .	492
12.5	The different views of a large inclination angle . . . . .	493
12.6	The three different Mach numbers . . . . .	495
12.7	The "imaginary" Mach waves at zero inclination . . . . .	499
12.8	The possible range of solutions . . . . .	501
12.9	Two dimensional wedge . . . . .	503
12.10	A local and a far view of the oblique shock. . . . .	504
12.11	Oblique shock around a cone . . . . .	506
12.12	Maximum values of the properties in an oblique shock . . . . .	507
12.13	Two variations of inlet suction for supersonic flow . . . . .	508
12.14	Schematic for Example (12.5) . . . . .	508
12.15	Schematic for Example (12.6) . . . . .	510
12.16	Schematic of two angles turn with two weak shocks . . . . .	510
12.17	Schematic for Example (12.11) . . . . .	514
12.18	Illustration for Example (12.14) . . . . .	517
12.19	Revisiting of shock drag diagram for the oblique shock. . . . .	519
12.21	Definition of the angle for the Prandtl–Meyer function . . . . .	520

12.22	The angles of the Mach line triangle . . . . .	520
12.23	The schematic of the turning flow . . . . .	521
12.24	The mathematical coordinate description . . . . .	522
12.25	Prandtl-Meyer function after the maximum angle . . . . .	526
12.27	Diamond shape for supersonic d'Alembert's Paradox . . . . .	527
12.28	The definition of attack angle for the Prandtl-Meyer function . . . . .	527
12.29	Schematic for Example (12.5) . . . . .	528
12.30	Schematic for the reversed question of Example 12.17 . . . . .	529
12.20	Oblique $\delta - \theta - M$ relationship figure . . . . .	533
12.26	The angle as a function of the Mach number . . . . .	534
12.31	Schematic of the nozzle and Prandtl-Meyer expansion. . . . .	534
13.1	Different fields of multi phase flow. . . . .	537
13.2	Stratified flow in horizontal tubes when the liquids flow is very slow. . .	539
13.3	Kind of Stratified flow in horizontal tubes. . . . .	540
13.4	Plug flow in horizontal tubes with the liquids flow is faster. . . . .	540
13.5	Modified Mandhane map for flow regime in horizontal tubes. . . . .	541
13.6	Gas and liquid in Flow in vertical tube against the gravity. . . . .	542
13.7	A dimensional vertical flow map low gravity against gravity. . . . .	543
13.8	The terminal velocity that left the solid particles. . . . .	553
13.9	The flow patterns in solid-liquid flow. . . . .	554
13.10	Counter-flow in vertical tubes map. . . . .	555
13.11	Counter-current flow in a can. . . . .	555
13.12	Image of counter-current flow in liquid-gas/solid-gas configurations. . .	556
13.13	Flood in vertical pipe. . . . .	557
13.14	A flow map to explain the horizontal counter-current flow. . . . .	557
13.15	A diagram to explain the flood in a two dimension geometry. . . . .	558
13.16	General forces diagram to calculated the in a two dimension geometry. .	563
A.1	Vector in Cartesian coordinates system . . . . .	567
A.2	The right hand rule . . . . .	568
A.3	Cylindrical Coordinate System . . . . .	574
A.4	Spherical Coordinate System . . . . .	575
A.5	The general Orthogonal with unit vectors . . . . .	576
A.6	Parabolic coordinates by user WillowW using Blender . . . . .	577
A.7	The tringle angles sides . . . . .	595



---

# LIST OF TABLES

1	Books Under Potto Project . . . . .	I
1.3	Viscosity of selected liquids . . . . .	12
1.3	continue . . . . .	13
1.1	Sutherland's equation coefficients . . . . .	14
1.2	Viscosity of selected gases . . . . .	14
1.4	Properties at the critical stage . . . . .	15
1.5	Bulk modulus for selected materials . . . . .	24
1.5	continue . . . . .	25
1.6	The contact angle for air/water with selected materials. . . . .	36
1.7	The surface tension for selected materials. . . . .	42
1.7	continue . . . . .	43
2.1	Properties of Various Ideal Gases [300K] . . . . .	50
3.1	Moments of Inertia full shape. . . . .	67
3.2	Moment of inertia for various plane surfaces . . . . .	68
9.1	Basic Units of Two Common Systems . . . . .	275
9.1	continue . . . . .	276
9.2	Units of the Pendulum . . . . .	279
9.3	Physical Units for Two Common Systems . . . . .	283
9.3	continue . . . . .	284
9.3	continue . . . . .	285
9.4	Dimensional matrix . . . . .	287
9.5	Units of the Pendulum . . . . .	293
9.6	gold grain dimensional matrix . . . . .	294
9.7	Units of the Pendulum . . . . .	298

9.8	Common Dimensionless Parameters of Thermo-Fluid in the Field . . . .	309
9.8	continue . . . . .	310
9.8	continue . . . . .	311
10.1	Simple Solution to Laplaces' Equation . . . . .	374
10.2	Axisymetrical 3-D Flow . . . . .	374
10.2	continue . . . . .	375
11.1	Fliegner's number a function of Mach number . . . . .	397
11.1	continue . . . . .	398
11.1	continue . . . . .	399
11.1	continue . . . . .	400
11.1	continue . . . . .	401
11.2	Isentropic Table $k = 1.4$ . . . . .	402
11.2	continue . . . . .	403
11.3	The shock wave table for $k = 1.4$ . . . . .	418
11.3	continue . . . . .	419
11.3	continue . . . . .	420
11.3	continue . . . . .	421
11.4	The Isothermal Flow basic parameters . . . . .	429
11.4	The Isothermal Flow basic parameters (continue) . . . . .	430
11.5	The flow parameters for unchoked flow . . . . .	436
11.6	Fanno Flow Standard basic Table $k=1.4$ . . . . .	469
11.6	continue . . . . .	470
11.6	continue . . . . .	471
11.7	Rayleigh Flow $k=1.4$ . . . . .	475
11.7	continue . . . . .	476
11.7	continue . . . . .	477
11.7	continue . . . . .	478
12.1	Table of maximum values of the oblique Shock $k=1.4$ . . . . .	504
12.1	continue . . . . .	505
A.1	Orthogonal coordinates systems (under construction please ignore) . . .	578

---

# NOMENCLATURE

$\bar{R}$	Universal gas constant, see equation (2.26), page 49
$\tau$	The shear stress Tensor, see equation (6.7), page 174
$\ell$	Units length., see equation (2.1), page 45
$\hat{n}$	unit vector normal to surface of constant property, see equation (10.17), page 329
$\lambda$	bulk viscosity, see equation (8.101), page 253
$\mathfrak{M}$	Angular Momentum, see equation (6.38), page 190
$\mu$	viscosity at input temperature T, see equation (1.17), page 12
$\mu_0$	reference viscosity at reference temperature, $T_{i0}$ , see equation (1.17), page 12
$\mathbf{F}_{ext}$	External forces by non-fluids means, see equation (6.11), page 175
$\mathbf{U}$	The velocity taken with the direction, see equation (6.1), page 173
$\rho$	Density of the fluid, see equation (11.1), page 379
$\Xi$	Martinelli parameter, see equation (13.43), page 551
$A$	The area of surface, see equation (4.139), page 110
$a$	The acceleration of object or system, see equation (4.0), page 69
$B_f$	Body force, see equation (2.9), page 47
$B_T$	bulk modulus, see equation (11.16), page 382
$c$	Speed of sound, see equation (11.1), page 379

$c.v.$	subscribe for control volume, see equation (5.0), page 148
$C_p$	Specific pressure heat, see equation (2.23), page 49
$C_v$	Specific volume heat, see equation (2.22), page 49
$E$	Young's modulus, see equation (11.17), page 382
$E_U$	Internal energy, see equation (2.3), page 46
$E_u$	Internal Energy per unit mass, see equation (2.6), page 46
$E_i$	System energy at state $i$ , see equation (2.2), page 46
$G$	The gravitation constant, see equation (4.69), page 91
$g_c$	general Body force, see equation (4.0), page 69
$H$	Enthalpy, see equation (2.18), page 48
$h$	Specific enthalpy, see equation (2.18), page 48
$k$	the ratio of the specific heats, see equation (2.24), page 49
$k_T$	Fluid thermal conductivity, see equation (7.3), page 198
$L$	Angular momentum, see equation (3.40), page 65
$M$	Mach number, see equation (11.24), page 385
$P$	Pressure, see equation (11.3), page 379
$P_{atmos}$	Atmospheric Pressure, see equation (4.107), page 102
$q$	Energy per unit mass, see equation (2.6), page 46
$Q_{12}$	The energy transferred to the system between state 1 and state 2, see equation (2.2), page 46
$R$	Specific gas constant, see equation (2.27), page 50
$S$	Entropy of the system, see equation (2.13), page 48
$S_{uth}$	Suth is Sutherland's constant and it is presented in the Table 1.1, see equation (1.17), page 12
$T_\tau$	Torque, see equation (3.42), page 66
$T_{i0}$	reference temperature in degrees Kelvin, see equation (1.17), page 12
$T_{in}$	input temperature in degrees Kelvin, see equation (1.17), page 12
$U$	velocity , see equation (2.4), page 46



- $w$  Work per unit mass, see equation (2.6), page 46
- $W_{12}$  The work done by the system between state 1 and state 2, see equation (2.2), page 46
- $z$  the coordinate in  $z$  direction, see equation (4.14), page 72
- says Subscribe says, see equation (5.0), page 148



---

# The Book Change Log

## *Version 0.3.4.0*

**July 25, 2013 (8.9 M 666 pages)**

- Add the skeleton of inviscid flow

## *Version 0.3.3.0*

**March 17, 2013 (4.8 M 617 pages)**

- Add the skeleton of 2-D compressible flow
- English and minor corrections in various chapters.

## *Version 0.3.2.0*

**March 11, 2013 (4.2 M 553 pages)**

- Add the skeleton of 1-D compressible flow
- English and minor corrections in various chapters.

## *Version 0.3.1.1*

**Dec 21, 2011 (3.6 M 452 pages)**

- Minor additions to the Dimensional Analysis chapter.
- English and minor corrections in various chapters.

*Version 0.3.1.0***Dec 13, 2011 (3.6 M 446 pages)**

- Addition of the Dimensional Analysis chapter skeleton.
- English and minor corrections in various chapters.

*Version 0.3.0.4***Feb 23, 2011 (3.5 M 392 pages)**

- Insert discussion about Pushka equation and bulk modulus.
- Addition of several examples integral Energy chapter.
- English and addition of other minor examples in various chapters.

*Version 0.3.0.3***Dec 5, 2010 (3.3 M 378 pages)**

- Add additional discussion about bulk modulus of geological system.
- Addition of several examples with respect speed of sound with variation density under bulk modulus. This addition was to go the compressible book and will migrate to there when the book will brought up to code.
- Brought the mass conservation chapter to code.
- additional examples in mass conservation chapter.

*Version 0.3.0.2***Nov 19, 2010 (3.3 M 362 pages)**

- Further improved the script for the chapter log file for latex (macro) process.
- Add discussion change of bulk modulus of mixture.
- Addition of several examples.
- Improve English in several chapters.

*Version 0.3.0.1***Nov 12, 2010 (3.3 M 358 pages)**

- Build the chapter log file for latex (macro) process Steven from [www.artofproblemsolving.com](http://www.artofproblemsolving.com).

- Add discussion change of density on buck modulus calculations as example as integral equation.
- Minimal discussion of converting integral equation to differential equations.
- Add several examples on surface tension.
- Improvement of properties chapter.
- Improve English in several chapters.

### *Version 0.3.0.0*

#### **Oct 24, 2010 (3.3 M 354 pages)**

- Change the emphasis equations to new style in Static chapter.
- Add discussion about inclined manometer
- Improve many figures and equations in Static chapter.
- Add example of falling liquid gravity as driving force in presence of shear stress.
- Improve English in static and mostly in differential analysis chapter.

### *Version 0.2.9.1*

#### **Oct 11, 2010 (3.3 M 344 pages)**

- Change the emphasis equations to new style in Thermo chapter.
- Correct the ideal gas relationship typo thanks to Michal Zadrozny.
- Add example, change to the new empheq format and improve cylinder figure.
- Add to the appendix the differentiation of vector operations.
- Minor correction to to the wording in page 11 viscosity density issue (thanks to Prashant Balan).
- Add example to dif chap on concentric cylinders poiseuille flow.

### *Version 0.2.9*

#### **Sep 20, 2010 (3.3 M 338 pages)**

- Initial release of the differential equations chapter.
- Improve the emphasis macro for the important equation and useful equation.

*Version 0.2.6***March 10, 2010 (2.9 M 280 pages)**

- add example to Mechanical Chapter and some spelling corrected.

*Version 0.2.4***March 01, 2010 (2.9 M 280 pages)**

- The energy conservation chapter was released.
- Some additions to mass conservation chapter on averaged velocity.
- Some additions to momentum conservation chapter.
- Additions to the mathematical appendix on vector algebra.
- Additions to the mathematical appendix on variables separation in second order ode equations.
- Add the macro protect to insert figure in lower right corner thanks to Steven from [www.artofproblemsolving.com](http://www.artofproblemsolving.com).
- Add the macro to improve emphases equation thanks to Steven from [www.artofproblemsolving.com](http://www.artofproblemsolving.com).
- Add example about the the third component of the velocity.
- English corrections, Thanks to Eliezer Bar-Meir

*Version 0.2.3***Jan 01, 2010 (2.8 M 241 pages)**

- The momentum conservation chapter was released.
- Corrections to Static Chapter.
- Add the macro ekes to equations in examples thanks to Steven from [www.artofproblemsolving.com](http://www.artofproblemsolving.com).
- English corrections, Thanks to Eliezer Bar-Meir

*Version 0.1.9***Dec 01, 2009 (2.6 M 219 pages)**

- The mass conservation chapter was released.
- Add Reynold's Transform explanation.
- Add example on angular rotation to statics chapter.

- Add the open question concept. Two open questions were released.
- English corrections, Thanks to Eliezer Bar-Meir

*Version 0.1.8.5*

**Nov 01, 2009 (2.5 M 203 pages)**

- First true draft for the mass conservation.
- Improve the dwarfing macro to allow flexibility with sub title.
- Add the first draft of the temperature-velocity diagram to the Therm's chapter.

*Version 0.1.8.1*

**Sep 17, 2009 (2.5 M 197 pages)**

- Continue fixing the long titles issues.
- Add some examples to static chapter.
- Add an example to mechanics chapter.

*Version 0.1.8a*

**July 5, 2009 (2.6 M 183 pages)**

- Fixing some long titles issues.
- Correcting the gas properties tables (thanks to Heru and Micheal)
- Move the gas tables to common area to all the books.

*Version 0.1.8*

**Aug 6, 2008 (2.4 M 189 pages)**

- Add the chapter on introduction to multi-phase flow
- Again additional improvement to the index (thanks to Irene).
- Add the Rayleigh-Taylor instability.
- Improve the doChap scrip to break up the book to chapters.

*Version 0.1.6***Jun 30, 2008 (1.3 M 151 pages)**

- Fix the English in the introduction chapter, (thanks to Touser).
- Improve the Index (thanks to Irene).
- Remove the multiphase chapter (it is not for public consumption yet).

*Version 0.1.5a***Jun 11, 2008 (1.4 M 155 pages)**

- Add the constant table list for the introduction chapter.
- Fix minor issues (English) in the introduction chapter.

*Version 0.1.5***Jun 5, 2008 (1.4 M 149 pages)**

- Add the introduction, viscosity and other properties of fluid.
- Fix very minor issues (English) in the static chapter.

*Version 0.1.1***May 8, 2008 (1.1 M 111 pages)**

- Major English corrections for the three chapters.
- Add the product of inertia to mechanics chapter.
- Minor corrections for all three chapters.

Version 0.1a April 23, 2008

*Version 0.1a***April 23, 2008**

- The Thermodynamics chapter was released.
- The mechanics chapter was released.
- The static chapter was released (the most extensive and detailed chapter).



---

# Notice of Copyright For This Document:

This document is published under modified FDL. The change of the license is to prevent from situations that the author has to buy his own book. The Potto Project License doesn't long apply to this document and associated documents.

## *GNU Free Documentation License*

The modification is that under section 3 "copying in quantity" should be add in the end.

"If you print more than 200 copies, you are required to furnish the author with two (2) copies of the printed book."

Version 1.2, November 2002  
Copyright ©2000,2001,2002 Free Software Foundation, Inc.

51 Franklin St, Fifth Floor, Boston, MA 02110-1301 USA

Everyone is permitted to copy and distribute verbatim copies of this license document, but changing it is not allowed.

### **Preamble**

The purpose of this License is to make a manual, textbook, or other functional and useful document "free" in the sense of freedom: to assure everyone the effective freedom to copy and redistribute it, with or without modifying it, either commercially or noncommercially. Secondly, this License preserves for the author and

publisher a way to get credit for their work, while not being considered responsible for modifications made by others.

This License is a kind of "copyleft", which means that derivative works of the document must themselves be free in the same sense. It complements the GNU General Public License, which is a copyleft license designed for free software.

We have designed this License in order to use it for manuals for free software, because free software needs free documentation: a free program should come with manuals providing the same freedoms that the software does. But this License is not limited to software manuals; it can be used for any textual work, regardless of subject matter or whether it is published as a printed book. We recommend this License principally for works whose purpose is instruction or reference.

## 1. APPLICABILITY AND DEFINITIONS

This License applies to any manual or other work, in any medium, that contains a notice placed by the copyright holder saying it can be distributed under the terms of this License. Such a notice grants a world-wide, royalty-free license, unlimited in duration, to use that work under the conditions stated herein. The "**Document**", below, refers to any such manual or work. Any member of the public is a licensee, and is addressed as "**you**". You accept the license if you copy, modify or distribute the work in a way requiring permission under copyright law.

A "**Modified Version**" of the Document means any work containing the Document or a portion of it, either copied verbatim, or with modifications and/or translated into another language.

A "**Secondary Section**" is a named appendix or a front-matter section of the Document that deals exclusively with the relationship of the publishers or authors of the Document to the Document's overall subject (or to related matters) and contains nothing that could fall directly within that overall subject. (Thus, if the Document is in part a textbook of mathematics, a Secondary Section may not explain any mathematics.) The relationship could be a matter of historical connection with the subject or with related matters, or of legal, commercial, philosophical, ethical or political position regarding them.

The "**Invariant Sections**" are certain Secondary Sections whose titles are designated, as being those of Invariant Sections, in the notice that says that the Document is released under this License. If a section does not fit the above definition of Secondary then it is not allowed to be designated as Invariant. The Document may contain zero Invariant Sections. If the Document does not identify any Invariant Sections then there are none.

The "**Cover Texts**" are certain short passages of text that are listed, as Front-Cover Texts or Back-Cover Texts, in the notice that says that the Document is released under this License. A Front-Cover Text may be at most 5 words, and a Back-Cover Text may be at most 25 words.

A "**Transparent**" copy of the Document means a machine-readable copy, represented in a format whose specification is available to the general public, that is suitable for revising the document straightforwardly with generic text editors or (for

images composed of pixels) generic paint programs or (for drawings) some widely available drawing editor, and that is suitable for input to text formatters or for automatic translation to a variety of formats suitable for input to text formatters. A copy made in an otherwise Transparent file format whose markup, or absence of markup, has been arranged to thwart or discourage subsequent modification by readers is not Transparent. An image format is not Transparent if used for any substantial amount of text. A copy that is not "Transparent" is called "**Opaque**".

Examples of suitable formats for Transparent copies include plain ASCII without markup, Texinfo input format, LaTeX input format, SGML or XML using a publicly available DTD, and standard-conforming simple HTML, PostScript or PDF designed for human modification. Examples of transparent image formats include PNG, XCF and JPG. Opaque formats include proprietary formats that can be read and edited only by proprietary word processors, SGML or XML for which the DTD and/or processing tools are not generally available, and the machine-generated HTML, PostScript or PDF produced by some word processors for output purposes only.

The "**Title Page**" means, for a printed book, the title page itself, plus such following pages as are needed to hold, legibly, the material this License requires to appear in the title page. For works in formats which do not have any title page as such, "Title Page" means the text near the most prominent appearance of the work's title, preceding the beginning of the body of the text.

A section "**Entitled XYZ**" means a named subunit of the Document whose title either is precisely XYZ or contains XYZ in parentheses following text that translates XYZ in another language. (Here XYZ stands for a specific section name mentioned below, such as "**Acknowledgements**", "**Dedications**", "**Endorsements**", or "**History**".) To "**Preserve the Title**" of such a section when you modify the Document means that it remains a section "Entitled XYZ" according to this definition.

The Document may include Warranty Disclaimers next to the notice which states that this License applies to the Document. These Warranty Disclaimers are considered to be included by reference in this License, but only as regards disclaiming warranties: any other implication that these Warranty Disclaimers may have is void and has no effect on the meaning of this License.

## 2. VERBATIM COPYING

You may copy and distribute the Document in any medium, either commercially or noncommercially, provided that this License, the copyright notices, and the license notice saying this License applies to the Document are reproduced in all copies, and that you add no other conditions whatsoever to those of this License. You may not use technical measures to obstruct or control the reading or further copying of the copies you make or distribute. However, you may accept compensation in exchange for copies. If you distribute a large enough number of copies you must also follow the conditions in section 3.

You may also lend copies, under the same conditions stated above, and you may publicly display copies.

## 3. COPYING IN QUANTITY

If you publish printed copies (or copies in media that commonly have printed covers) of the Document, numbering more than 100, and the Document's license notice requires Cover Texts, you must enclose the copies in covers that carry, clearly and legibly, all these Cover Texts: Front-Cover Texts on the front cover, and Back-Cover Texts on the back cover. Both covers must also clearly and legibly identify you as the publisher of these copies. The front cover must present the full title with all words of the title equally prominent and visible. You may add other material on the covers in addition. Copying with changes limited to the covers, as long as they preserve the title of the Document and satisfy these conditions, can be treated as verbatim copying in other respects.

If the required texts for either cover are too voluminous to fit legibly, you should put the first ones listed (as many as fit reasonably) on the actual cover, and continue the rest onto adjacent pages.

If you publish or distribute Opaque copies of the Document numbering more than 100, you must either include a machine-readable Transparent copy along with each Opaque copy, or state in or with each Opaque copy a computer-network location from which the general network-using public has access to download using public-standard network protocols a complete Transparent copy of the Document, free of added material. If you use the latter option, you must take reasonably prudent steps, when you begin distribution of Opaque copies in quantity, to ensure that this Transparent copy will remain thus accessible at the stated location until at least one year after the last time you distribute an Opaque copy (directly or through your agents or retailers) of that edition to the public.

It is requested, but not required, that you contact the authors of the Document well before redistributing any large number of copies, to give them a chance to provide you with an updated version of the Document.

## 4. MODIFICATIONS

You may copy and distribute a Modified Version of the Document under the conditions of sections 2 and 3 above, provided that you release the Modified Version under precisely this License, with the Modified Version filling the role of the Document, thus licensing distribution and modification of the Modified Version to whoever possesses a copy of it. In addition, you must do these things in the Modified Version:

- A. Use in the Title Page (and on the covers, if any) a title distinct from that of the Document, and from those of previous versions (which should, if there were any, be listed in the History section of the Document). You may use the same title as a previous version if the original publisher of that version gives permission.
- B. List on the Title Page, as authors, one or more persons or entities responsible for authorship of the modifications in the Modified Version, together with at least five of the principal authors of the Document (all of its principal authors, if it has fewer than five), unless they release you from this requirement.
- C. State on the Title page the name of the publisher of the Modified Version, as the publisher.

- D. Preserve all the copyright notices of the Document.
- E. Add an appropriate copyright notice for your modifications adjacent to the other copyright notices.
- F. Include, immediately after the copyright notices, a license notice giving the public permission to use the Modified Version under the terms of this License, in the form shown in the Addendum below.
- G. Preserve in that license notice the full lists of Invariant Sections and required Cover Texts given in the Document's license notice.
- H. Include an unaltered copy of this License.
  - I. Preserve the section Entitled "History", Preserve its Title, and add to it an item stating at least the title, year, new authors, and publisher of the Modified Version as given on the Title Page. If there is no section Entitled "History" in the Document, create one stating the title, year, authors, and publisher of the Document as given on its Title Page, then add an item describing the Modified Version as stated in the previous sentence.
  - J. Preserve the network location, if any, given in the Document for public access to a Transparent copy of the Document, and likewise the network locations given in the Document for previous versions it was based on. These may be placed in the "History" section. You may omit a network location for a work that was published at least four years before the Document itself, or if the original publisher of the version it refers to gives permission.
  - K. For any section Entitled "Acknowledgements" or "Dedications", Preserve the Title of the section, and preserve in the section all the substance and tone of each of the contributor acknowledgements and/or dedications given therein.
  - L. Preserve all the Invariant Sections of the Document, unaltered in their text and in their titles. Section numbers or the equivalent are not considered part of the section titles.
- M. Delete any section Entitled "Endorsements". Such a section may not be included in the Modified Version.
- N. Do not retitle any existing section to be Entitled "Endorsements" or to conflict in title with any Invariant Section.
- O. Preserve any Warranty Disclaimers.

If the Modified Version includes new front-matter sections or appendices that qualify as Secondary Sections and contain no material copied from the Document, you may at your option designate some or all of these sections as invariant. To do this, add their titles to the list of Invariant Sections in the Modified Version's license notice. These titles must be distinct from any other section titles.

You may add a section Entitled "Endorsements", provided it contains nothing but endorsements of your Modified Version by various parties—for example, statements of peer review or that the text has been approved by an organization as the authoritative definition of a standard.

You may add a passage of up to five words as a Front-Cover Text, and a passage of up to 25 words as a Back-Cover Text, to the end of the list of Cover Texts in the Modified Version. Only one passage of Front-Cover Text and one of Back-Cover Text may be added by (or through arrangements made by) any one entity. If the Document already includes a cover text for the same cover, previously added by you or by arrangement made by the same entity you are acting on behalf of, you may not add another; but you may replace the old one, on explicit permission from the previous publisher that added the old one.

The author(s) and publisher(s) of the Document do not by this License give permission to use their names for publicity for or to assert or imply endorsement of any Modified Version.

## 5. COMBINING DOCUMENTS

You may combine the Document with other documents released under this License, under the terms defined in section 4 above for modified versions, provided that you include in the combination all of the Invariant Sections of all of the original documents, unmodified, and list them all as Invariant Sections of your combined work in its license notice, and that you preserve all their Warranty Disclaimers.

The combined work need only contain one copy of this License, and multiple identical Invariant Sections may be replaced with a single copy. If there are multiple Invariant Sections with the same name but different contents, make the title of each such section unique by adding at the end of it, in parentheses, the name of the original author or publisher of that section if known, or else a unique number. Make the same adjustment to the section titles in the list of Invariant Sections in the license notice of the combined work.

In the combination, you must combine any sections Entitled "History" in the various original documents, forming one section Entitled "History"; likewise combine any sections Entitled "Acknowledgements", and any sections Entitled "Dedications". You must delete all sections Entitled "Endorsements".

## 6. COLLECTIONS OF DOCUMENTS

You may make a collection consisting of the Document and other documents released under this License, and replace the individual copies of this License in the various documents with a single copy that is included in the collection, provided that you follow the rules of this License for verbatim copying of each of the documents in all other respects.

You may extract a single document from such a collection, and distribute it individually under this License, provided you insert a copy of this License into the extracted document, and follow this License in all other respects regarding verbatim copying of that document.

## 7. AGGREGATION WITH INDEPENDENT WORKS

A compilation of the Document or its derivatives with other separate and independent documents or works, in or on a volume of a storage or distribution medium, is called an "aggregate" if the copyright resulting from the compilation is not used to limit the legal rights of the compilation's users beyond what the individual works permit. When the Document is included in an aggregate, this License does not apply to the other works in the aggregate which are not themselves derivative works of the Document.

If the Cover Text requirement of section 3 is applicable to these copies of the Document, then if the Document is less than one half of the entire aggregate, the Document's Cover Texts may be placed on covers that bracket the Document within the aggregate, or the electronic equivalent of covers if the Document is in electronic form. Otherwise they must appear on printed covers that bracket the whole aggregate.

## 8. TRANSLATION

Translation is considered a kind of modification, so you may distribute translations of the Document under the terms of section 4. Replacing Invariant Sections with translations requires special permission from their copyright holders, but you may include translations of some or all Invariant Sections in addition to the original versions of these Invariant Sections. You may include a translation of this License, and all the license notices in the Document, and any Warranty Disclaimers, provided that you also include the original English version of this License and the original versions of those notices and disclaimers. In case of a disagreement between the translation and the original version of this License or a notice or disclaimer, the original version will prevail.

If a section in the Document is Entitled "Acknowledgements", "Dedications", or "History", the requirement (section 4) to Preserve its Title (section 1) will typically require changing the actual title.

## 9. TERMINATION

You may not copy, modify, sublicense, or distribute the Document except as expressly provided for under this License. Any other attempt to copy, modify, sublicense or distribute the Document is void, and will automatically terminate your rights under this License. However, parties who have received copies, or rights, from you under this License will not have their licenses terminated so long as such parties remain in full compliance.

## 10. FUTURE REVISIONS OF THIS LICENSE

The Free Software Foundation may publish new, revised versions of the GNU Free Documentation License from time to time. Such new versions will be similar in spirit to the present version, but may differ in detail to address new problems or concerns. See <http://www.gnu.org/copyleft/>.

Each version of the License is given a distinguishing version number. If the Document specifies that a particular numbered version of this License "or any later

version" applies to it, you have the option of following the terms and conditions either of that specified version or of any later version that has been published (not as a draft) by the Free Software Foundation. If the Document does not specify a version number of this License, you may choose any version ever published (not as a draft) by the Free Software Foundation.

### **ADDENDUM: How to use this License for your documents**

To use this License in a document you have written, include a copy of the License in the document and put the following copyright and license notices just after the title page:

Copyright ©YEAR YOUR NAME. Permission is granted to copy, distribute and/or modify this document under the terms of the GNU Free Documentation License, Version 1.2 or any later version published by the Free Software Foundation; with no Invariant Sections, no Front-Cover Texts, and no Back-Cover Texts. A copy of the license is included in the section entitled "GNU Free Documentation License".

If you have Invariant Sections, Front-Cover Texts and Back-Cover Texts, replace the "with...Texts." line with this:

with the Invariant Sections being LIST THEIR TITLES, with the Front-Cover Texts being LIST, and with the Back-Cover Texts being LIST.

If you have Invariant Sections without Cover Texts, or some other combination of the three, merge those two alternatives to suit the situation.

If your document contains nontrivial examples of program code, we recommend releasing these examples in parallel under your choice of free software license, such as the GNU General Public License, to permit their use in free software.



---

# CONTRIBUTOR LIST

## *How to contribute to this book*

As a copylefted work, this book is open to revisions and expansions by any interested parties. The only "catch" is that credit must be given where credit is due. This *is* a copyrighted work: it is *not* in the public domain!

If you wish to cite portions of this book in a work of your own, you must follow the same guidelines as for any other GDL copyrighted work.

## *Credits*

All entries have been arranged in alphabetical order of surname (hopefully. Major contributions are listed by individual name with some detail on the nature of the contribution(s), date, contact info, etc. Minor contributions (typo corrections, etc.) are listed by name only for reasons of brevity. Please understand that when I classify a contribution as "minor," it is in no way inferior to the effort or value of a "major" contribution, just smaller in the sense of less text changed. Any and all contributions are gratefully accepted. I am indebted to all those who have given freely of their own knowledge, time, and resources to make this a better book!

- **Date(s) of contribution(s):** 1999 to present
- **Nature of contribution:** Original author.
- **Contact at:** barmeir at gmail.com

### **Steven from [artofproblemsolving.com](http://artofproblemsolving.com)**

- **Date(s) of contribution(s):** June 2005, Dec, 2009

- **Nature of contribution:** LaTeX formatting, help on building the useful equation and important equation macros.
- **Nature of contribution:** In 2009 creating the exEq macro to have different counter for example.

### Dan H. Olson

- **Date(s) of contribution(s):** April 2008
- **Nature of contribution:** Some discussions about chapter on mechanics and correction of English.

### Richard Hackbarth

- **Date(s) of contribution(s):** April 2008
- **Nature of contribution:** Some discussions about chapter on mechanics and correction of English.

### John Herbolenes

- **Date(s) of contribution(s):** August 2009
- **Nature of contribution:** Provide some example for the static chapter.

### Eliezer Bar-Meir

- **Date(s) of contribution(s):** Nov 2009, Dec 2009
- **Nature of contribution:** Correct many English mistakes Mass.
- **Nature of contribution:** Correct many English mistakes Momentum.

### Henry Schoumertate

- **Date(s) of contribution(s):** Nov 2009
- **Nature of contribution:** Discussion on the mathematics of Reynolds Transforms.

### Your name here

- **Date(s) of contribution(s):** Month and year of contribution
- **Nature of contribution:** Insert text here, describing how you contributed to the book.
- **Contact at:** my\_email@provider.net

**Typo corrections and other "minor" contributions**

- **R. Gupta**, January 2008, help with the original **img** macro and other ( LaTeX issues).
- **Tousher Yang** April 2008, review of statics and thermo chapters.
- Correction to equation (2.38) by Michal Zadrozny. (Nov 2010) Correction to wording in viscosity density Prashant Balan. (Nov 2010)



---

## About This Author

Genick Bar-Meir is a world-renowned and leading scientist who holds a Ph.D. in Mechanical Engineering from University of Minnesota and a Master in Fluid Mechanics from Tel Aviv University. Dr. Bar-Meir was the last student of the late Dr. R. G. E. Eckert. Bar-Meir is responsible for major advancements in Fluid mechanics, particularly in the pedagogy of Fluid Mechanics curriculum. Currently, he writes books (there are already three very popular books), and provides freelance consulting of applications in various fields of fluid mechanics. According the Alexa(.com) and <http://website-tools.net/> over 73% of the entire world download books are using Genick's book.

Bar-Meir also introduced a new methodology of Dimensional Analysis. Traditionally, Buckingham's Pi theorem is used as an exclusive method of Dimensional Analysis. Bar-Meir demonstrated that the Buckingham method provides only the minimum number of dimensionless parameters. This minimum number of parameters is insufficient to understand almost any physical phenomenon. He showed that the improved Nusselt's methods provides a complete number of dimensionless parameters and thus the key to understand the physical phenomenon. He extended Nusselt's methods and made it the cornerstone in the new standard curriculum of Fluid Mechanics class.

Recently, Bar-Meir developed a new foundation (theory) so that improved shock tubes can be built and utilized. This theory also contributes a new concept in thermodynamics, that of the pressure potential. Before that, one of the open question that remained in hydrostatics was what is the pressure at great depths. The previous common solution had been awkward and complex numerical methods. Bar-Meir provided an elegant analytical foundation to compute the parameters in this phenomenon. This solution has practical applications in finding depth at great ocean depths and answering questions of geological scale problems.

In the area of compressible flow, it was commonly believed and taught that there is only weak and strong shock and it is continued by the Prandtl-Meyer function. Bar-Meir discovered the analytical solution for oblique shock and showed that there is

a “quiet” zone between the oblique shock and Prandtl–Meyer (isentropic expansion) flow. He also built analytical solution to several moving shock cases. He described and categorized the filling and evacuating of chamber by compressible fluid in which he also found analytical solutions to cases where the working fluid was an ideal gas. The common explanation to Prandtl–Meyer function shows that flow can turn in a sharp corner. Engineers have constructed a design that is based on this conclusion. Bar-Meir demonstrated that common Prandtl–Meyer explanation violates the conservation of mass and therefore the turn must be a round and finite radius. The author’s explanations on missing diameter and other issues in Fanno flow and “naughty professor’s question” are commonly used in various industries.

Earlier, Bar-Meir made many contributions to the manufacturing process and economy and particularly in the die casting area. This work is used as a base in many numerical works, in USA (for example, GM), British industries, Spain, and Canada. Bar-Meir’s contributions to the understanding of the die casting process made him the main leading figure in that area. Initially in his career, Bar-Meir developed a new understanding of Mass Transfer in high concentrations which are now building blocks for more complex situations.

The author lives with his wife and three children. A past project of his was building a four stories house, practically from scratch. While he writes his programs and does other computer chores, he often feels clueless about computers and programing. While he is known to look like he knows about many things, the author just know to learn quickly. The author spent years working on the sea (ships) as a engine sea officer but now the author prefers to remain on solid ground.

---

# Prologue For The POTTO Project

This books series was born out of frustrations in two respects. The first issue is the enormous price of college textbooks. It is unacceptable that the price of the college books will be over \$150 per book (over 10 hours of work for an average student in The United States).

The second issue that prompted the writing of this book is the fact that we as the public have to deal with a corrupted judicial system. As individuals we have to obey the law, particularly the copyright law with the “infinite<sup>1</sup>” time with the copyright holders. However, when applied to “small” individuals who are not able to hire a large legal firm, judges simply manufacture facts to make the little guy lose and pay for the defense of his work. On one hand, the corrupted court system defends the “big” guys and on the other hand, punishes the small “entrepreneur” who tries to defend his or her work. It has become very clear to the author and founder of the POTTO Project that this situation must be stopped. Hence, the creation of the POTTO Project. As R. Kook, one of this author’s sages, said instead of whining about arrogance and incorrectness, one should increase wisdom. This project is to increase wisdom and humility.

The Potto Project has far greater goals than simply correcting an abusive Judicial system or simply exposing abusive judges. It is apparent that writing textbooks especially for college students as a cooperation, like an open source, is a new idea<sup>2</sup>. Writing a book in the technical field is not the same as writing a novel. The writing of a technical book is really a collection of information and practice. There is always someone who can add to the book. The study of technical material isn’t only done by having to memorize the material, but also by coming to understand and be able to solve

---

<sup>1</sup>After the last decision of the Supreme Court in the case of Eldred v. Ashcroft (see <http://cyber.law.harvard.edu/openlaw/eldredvashcroft> for more information) copyrights practically remain indefinitely with the holder (not the creator).

<sup>2</sup>In some sense one can view the encyclopedia Wikipedia as an open content project (see [http://en.wikipedia.org/wiki/Main\\_Page](http://en.wikipedia.org/wiki/Main_Page)). The wikipedia is an excellent collection of articles which are written by various individuals.

related problems. The author has not found any technique that is more useful for this purpose than practicing the solving of problems and exercises. One can be successful when one solves as many problems as possible. To reach this possibility the collective book idea was created/adapted. While one can be as creative as possible, there are always others who can see new aspects of or add to the material. The collective material is much richer than any single person can create by himself.

The following example explains this point: The army ant is a kind of carnivorous ant that lives and hunts in the tropics, hunting animals that are even up to a hundred kilograms in weight. The secret of the ants' power lies in their collective intelligence. While a single ant is not intelligent enough to attack and hunt large prey, the collective power of their networking creates an extremely powerful intelligence to carry out this attack<sup>3</sup>. When an insect which is blind can be so powerful by networking, so can we in creating textbooks by this powerful tool.

Why would someone volunteer to be an author or organizer of such a book? This is the first question the undersigned was asked. The answer varies from individual to individual. It is hoped that because of the open nature of these books, they will become the most popular books and the most read books in their respected field. For example, the books on compressible flow and die casting became the most popular books in their respective area. In a way, the popularity of the books should be one of the incentives for potential contributors. The desire to be an author of a well-known book (at least in his/her profession) will convince some to put forth the effort. For some authors, the reason is the pure fun of writing and organizing educational material. Experience has shown that in explaining to others any given subject, one also begins to better understand the material. Thus, contributing to these books will help one to understand the material better. For others, the writing of or contributing to this kind of books will serve as a social function. The social function can have at least two components. One component is to come to know and socialize with many in the profession. For others the social part is as simple as a desire to reduce the price of college textbooks, especially for family members or relatives and those students lacking funds. For some contributors/authors, in the course of their teaching they have found that the textbook they were using contains sections that can be improved or that are not as good as their own notes. In these cases, they now have an opportunity to put their notes to use for others. Whatever the reasons, the undersigned believes that personal intentions are appropriate and are the author's/organizer's private affair.

If a contributor of a section in such a book can be easily identified, then that contributor will be the copyright holder of that specific section (even within question/answer sections). The book's contributor's names could be written by their sections. It is not just for experts to contribute, but also students who happened to be doing their homework. The student's contributions can be done by adding a question and perhaps the solution. Thus, this method is expected to accelerate the creation of these high quality books.

These books are written in a similar manner to the open source software

---

<sup>3</sup>see also in Franks, Nigel R.; "Army Ants: A Collective Intelligence," *American Scientist*, 77:139, 1989 (see for information <http://www.ex.ac.uk/bugclub/raiders.html>)



process. Someone has to write the skeleton and hopefully others will add “flesh and skin.” In this process, chapters or sections can be added after the skeleton has been written. It is also hoped that others will contribute to the question and answer sections in the book. But more than that, other books contain data<sup>4</sup> which can be typeset in L<sup>A</sup>T<sub>E</sub>X. These data (tables, graphs and etc.) can be redone by anyone who has the time to do it. Thus, the contributions to books can be done by many who are not experts. Additionally, contributions can be made from any part of the world by those who wish to translate the book.

It is hoped that the books will be error-free. Nevertheless, some errors are possible and expected. Even if not complete, better discussions or better explanations are all welcome to these books. These books are intended to be “continuous” in the sense that there will be someone who will maintain and improve the books with time (the organizer(s)).

These books should be considered more as a project than to fit the traditional definition of “plain” books. Thus, the traditional role of author will be replaced by an organizer who will be the one to compile the book. The organizer of the book in some instances will be the main author of the work, while in other cases only the gate keeper. This may merely be the person who decides what will go into the book and what will not (gate keeper). Unlike a regular book, these works will have a version number because they are alive and continuously evolving.

In the last 5 years three textbooks have been constructed which are available for download. These books contain innovative ideas which make some chapters the best in the world. For example, the chapters on Fanno flow and Oblique shock contain many original ideas such as the full analytical solution to the oblique shock, many algorithms for calculating Fanno flow parameters which are not found in any other book. In addition, Potto has auxiliary materials such as the gas dynamics tables (the largest compressible flow tables collection in the world), Gas Dynamics Calculator (Potto-GDC), etc.

The combined number downloads of these books is over half a million (December 2009) or in a rate of 20,000 copies a month. Potto books on compressible flow and fluid mechanics are used as the main textbook or as a reference book in several universities around the world. The books are used in more than 165 different countries around the world. Every month people from about 110 different countries download these books. The book on compressible flow is also used by “young engineers and scientists” in NASA according to Dr. Farassat, NASA Langley Research Center.

The undersigned of this document intends to be the organizer/author/coordinator of the projects in the following areas:

---

<sup>4</sup> Data are not copyrighted.

Table -1. Books under development in Potto project.

Project Name	Progress	Remarks	Version	Availability for Public Download
Compressible Flow	beta		0.4.8.2	✓
Die Casting	alpha		0.0.3	✓
Dynamics	NSY		0.0.0	✗
Fluid Mechanics	alpha		0.1.1	✓
Heat Transfer	NSY	Based on Eckert	0.0.0	✗
Mechanics	NSY		0.0.0	✗
Open Channel Flow	NSY		0.0.0	✗
Statics	early alpha	first chapter	0.0.1	✗
Strength of Material	NSY		0.0.0	✗
Thermodynamics	early alpha		0.0.01	✗
Two/Multi phases flow	NSY	Tel-Aviv' notes	0.0.0	✗

NSY = Not Started Yet

The meaning of the progress is as:

- The Alpha Stage is when some of the chapters are already in a rough draft;
- in Beta Stage is when all or almost all of the chapters have been written and are at least in a draft stage;
- in Gamma Stage is when all the chapters are written and some of the chapters are in a mature form; and
- the Advanced Stage is when all of the basic material is written and all that is left are aspects that are active, advanced topics, and special cases.

The mature stage of a chapter is when all or nearly all the sections are in a mature stage and have a mature bibliography as well as numerous examples for every section. The mature stage of a section is when all of the topics in the section are written, and all of the examples and data (tables, figures, etc.) are already presented. While some terms are defined in a relatively clear fashion, other definitions give merely a hint on the status. But such a thing is hard to define and should be enough for this stage.

The idea that a book can be created as a project has mushroomed from the open source software concept, but it has roots in the way science progresses. However, traditionally books have been improved by the same author(s), a process in which books

have a new version every a few years. There are book(s) that have continued after their author passed away, i.e., the *Boundary Layer Theory* originated<sup>5</sup> by Hermann Schlichting but continues to this day. However, projects such as the Linux Documentation project demonstrated that books can be written as the cooperative effort of many individuals, many of whom volunteered to help.

Writing a textbook is comprised of many aspects, which include the actual writing of the text, writing examples, creating diagrams and figures, and writing the  $\LaTeX$  macros<sup>6</sup> which will put the text into an attractive format. These chores can be done independently from each other and by more than one individual. Again, because of the open nature of this project, pieces of material and data can be used by different books.

---

<sup>5</sup>Originally authored by Dr. Schlichting, who passed way some years ago. A new version is created every several years.

<sup>6</sup>One can only expect that open source and readable format will be used for this project. But more than that, only  $\LaTeX$ , and perhaps troff, have the ability to produce the quality that one expects for these writings. The text processes, especially  $\LaTeX$ , are the only ones which have a cross platform ability to produce macros and a uniform feel and quality. Word processors, such as OpenOffice, Abiword, and Microsoft Word software, are not appropriate for these projects. Further, any text that is produced by Microsoft and kept in "Microsoft" format are against the spirit of this project In that they force spending money on Microsoft software.



---

# Prologue For This Book

*Version 0.3.2.0 March 18, 2013*

**pages 617 size 4.8M**

It is nice to see that the progress of the book is about 100 pages per year. As usual, the book contains new material that was not published before. While in the near future the focus will be on conversion to php, the main trust is planed to be on add several missing chapters. potto.sty was improved and subUsefulEquaiton was defined. For the content point of view two main chapters were add.

*Version 0.3.0.5 March 1, 2011*

**pages 400 size 3.5M**

A look on the progress which occur in the two and half years since the last time this page has been changed, shows that the book scientific part almost tripled. Three new chapters were added included that dealing with integral analysis and one chapter on differential analysis. Pushka equation (equation describing the density variation in great depth for slightly compressible material) was added yet not included in any other textbook. While the chapter on the fluid static is the best in the world (according to many including this author<sup>7</sup>), some material has to be expanded.

The potto style file has improved and including figures inside examples. Beside the Pushka equation, the book contains material that was not published in other books. Recently, many heavy duty examples were enhanced and thus the book quality. The meaning heavy duty example refers here to generalized cases. For example, showing the instability of the upside cone versus dealing with upside cone with specific angle.

---

<sup>7</sup>While this bragging is not appropriate in this kind of book it is to point the missing and additional further improvements needed.

*Version 0.1.8 August 6, 2008***pages 189 size 2.6M**

When this author was an undergraduate student, he spend time to study the wave phenomenon at the interface of open channel flow. This issue is related to renewal energy of extracting energy from brine solution (think about the Dead Sea, so much energy). The common explanation to the wave existence was that there is always a disturbance which causes instability. This author was bothered by this explanation. Now, in this version, it was proven that this wavy interface is created due to the need to satisfy the continuous velocity and shear stress at the interface and not a disturbance.

Potto project books are characterized by high quality which marked by presentation of the new developments and clear explanations. This explanation (on the wavy interface) demonstrates this characteristic of Potto project books. The introduction to multi-phase is another example to this quality. While it is a hard work to discover and develop and bring this information to the students, it is very satisfying for the author. The number of downloads of this book results from this quality. Even in this early development stage, number of downloads per month is about 5000 copies.

*Version 0.1 April 22, 2008***pages 151 size 1.3M**

The topic of fluid mechanics is common to several disciplines: mechanical engineering, aerospace engineering, chemical engineering, and civil engineering. In fact, it is also related to disciplines like industrial engineering, and electrical engineering. While the emphasis is somewhat different in this book, the common material is presented and hopefully can be used by all. One can only admire the wonderful advances done by the previous geniuses who work in this field. In this book it is hoped to insert, what and when a certain model is suitable than other models.

One of the difference in this book is the insertion of the introduction to multiphase flow. Clearly, multiphase is an advance topic. However, some minimal familiarity can be helpful for many engineers who have to deal with non pure single phase fluid.

This book is the third book in the series of POTTO project books. POTTO project books are open content textbooks so everyone are welcome to joint in. The topic of fluid mechanics was chosen just to fill the introduction chapter to compressible flow. During the writing it became apparent that it should be a book in its own right. In writing the chapter on fluid statics, there was a realization that it is the best chapter written on this topic. It is hoped that the other chapters will be as good this one.

This book is written in the spirit of my adviser and mentor E.R.G. Eckert. Eckert, aside from his research activity, wrote the book that brought a revolution in the education of the heat transfer. Up to Egret's book, the study of heat transfer was without any dimensional analysis. He wrote his book because he realized that the dimensional analysis utilized by him and his adviser (for the post doc), Ernst Schmidt,

and their colleagues, must be taught in engineering classes. His book met strong criticism in which some called to “burn” his book. Today, however, there is no known place in world that does not teach according to Eckert's doctrine. It is assumed that the same kind of individual(s) who criticized Eckert's work will criticize this work. Indeed, the previous book, on compressible flow, met its opposition. For example, anonymous Wikipedia user name EMBaero claimed that the material in the book is plagiarizing, he just doesn't know from where and what. Maybe that was the reason that he felt that is okay to plagiarize the book on Wikipedia. These criticisms will not change the future or the success of the ideas in this work. As a wise person says “don't tell me that it is wrong, show me what is wrong”; this is the only reply. With all the above, it must be emphasized that this book is not expected to revolutionize the field but change some of the way things are taught.

The book is organized into several chapters which, as a traditional textbook, deals with a basic introduction to the fluid properties and concepts (under construction). The second chapter deals with Thermodynamics. The third book chapter is a review of mechanics. The next topic is statics. When the Static Chapter was written, this author did not realize that so many new ideas will be inserted into this topic. As traditional texts in this field, ideal flow will be presented with the issues of added mass and added forces (under construction). The classic issue of turbulence (and stability) will be presented. An introduction to multi-phase flow, not a traditional topic, will be presented next (again under construction). The next two chapters will deal with open channel flow and gas dynamics. At this stage, dimensional analysis will be present (again under construction).





---

## How This Book Was Written

This book started because I needed an introduction to the compressible flow book. After a while it seems that is easier to write a whole book than the two original planned chapters. In writing this book, it was assumed that introductory book on fluid mechanics should not contained many new ideas but should be modern in the material presentation. There are numerous books on fluid mechanics but none of which is open content. The approach adapted in this book is practical, and more hands-on approach. This statement really meant that the book is intent to be used by students to solve their exams and also used by practitioners when they search for solutions for practical problems. So, issue of proofs so and so are here only either to explain a point or have a solution of exams. Otherwise, this book avoids this kind of issues.

The structure of Hansen, Streeter and Wylie, and Shames books were adapted and used as a scaffolding for this book. This author was influenced by Streeter and Wylie book which was his undergrad textbooks. The chapters are not written in order. The first 4 chapters were written first because they were supposed to be modified and used as fluid mechanics introduction in "Fundamentals of Compressible Flow." Later, multi-phase flow chapter was written.

The presentation of some of the chapters is slightly different from other books because the usability of the computers. The book does not provide the old style graphical solution methods yet provides the graphical explanation of things.

Of course, this book was written on Linux (Micro\$oftLess book). This book was written using the vim editor for editing (sorry never was able to be comfortable with emacs). The graphics were done by TGIF, the best graphic program that this author experienced so far. The figures were done by gle. The spell checking was done by ispell, and hope to find a way to use gaspell, a program that currently cannot be used on new Linux systems. The figure in cover page was created by Genick Bar-Meir, and is copyleft by him.



---

# Preface

*"In the beginning, the POTTO project was without form, and void; and emptiness was upon the face of the bits and files. And the Fingers of the Author moved upon the face of the keyboard. And the Author said, Let there be words, and there were words."*<sup>8</sup>.

This book, Basics of Fluid Mechanics, describes the fundamentals of fluid mechanics phenomena for engineers and others. This book is designed to replace all introductory textbook(s) or instructor's notes for the fluid mechanics in undergraduate classes for engineering/science students but also for technical peoples. It is hoped that the book could be used as a reference book for people who have at least some basics knowledge of science areas such as calculus, physics, etc.

The structure of this book is such that many of the chapters could be usable independently. For example, if you need information about, say, statics' equations, you can read just chapter (4). I hope this makes the book easier to use as a reference manual. However, this manuscript is first and foremost a textbook, and secondly a reference manual only as a lucky coincidence.

I have tried to describe why the theories are the way they are, rather than just listing "seven easy steps" for each task. This means that a lot of information is presented which is not necessary for everyone. These explanations have been marked as such and can be skipped.<sup>9</sup> Reading everything will, naturally, increase your understanding of the many aspects of fluid mechanics. Many in the industry, have called and emailed this author with questions since this book is only source in the world of some information. These questions have lead to more information and further explantion that is not found anywhre else.

This book is written and maintained on a volunteer basis. Like all volunteer work, there is a limit on how much effort I was able to put into the book and its organization. Moreover, due to the fact that English is my third language and time limitations, the explanations are not as good as if I had a few years to perfect them. Nevertheless, I believe professionals working in many engineering fields will benefit from

---

<sup>8</sup>To the power and glory of the mighty God. This book is only to explain his power.

<sup>9</sup>At the present, the book is not well organized. You have to remember that this book is a work in progress.

this information. This book contains many worked examples, which can be very useful for many. In fact, this book contains material that was not published anywhere else.

I have left some issues which have unsatisfactory explanations in the book, marked with a Mata mark. I hope to improve or to add to these areas in the near future. Furthermore, I hope that many others will participate of this project and will contribute to this book (even small contributions such as providing examples or editing mistakes are needed).

I have tried to make this text of the highest quality possible and am interested in your comments and ideas on how to make it better. Incorrect language, errors, ideas for new areas to cover, rewritten sections, more fundamental material, more mathematics (or less mathematics); I am interested in it all. I am particularly interested in the best arrangement of the book. If you want to be involved in the editing, graphic design, or proofreading, please drop me a line. You may contact me via Email at "barmeir@gmail.com".

Naturally, this book contains material that never was published before (sorry cannot avoid it). This material never went through a close content review. While close content peer review and publication in a professional publication is excellent idea in theory. In practice, this process leaves a large room to blockage of novel ideas and plagiarism. If you would like be "peer reviews" or critic to my new ideas please send me your comment(s). Even reaction/comments from individuals like David Marshall<sup>10</sup>.

Several people have helped me with this book, directly or indirectly. I would like to especially thank to my adviser, Dr. E. R. G. Eckert, whose work was the inspiration for this book. I also would like to thank to Jannie McRotien (Open Channel Flow chapter) and Touser Yang for their advices, ideas, and assistance.

The symbol META was added to provide typographical conventions to blurb as needed. This is mostly for the author's purposes and also for your amusement. There are also notes in the margin, but those are solely for the author's purposes, ignore them please. They will be removed gradually as the version number advances.

I encourage anyone with a penchant for writing, editing, graphic ability,  $\text{\LaTeX}$  knowledge, and material knowledge and a desire to provide open content textbooks and to improve them to join me in this project. If you have Internet e-mail access, you can contact me at "barmeir@gmail.com".

---

<sup>10</sup>Dr. Marshall wrote to this author that the author should review other people work before he write any thing new (well, literature review is always good, isn't it?). Over ten individuals wrote me about this letter. I am asking from everyone to assume that his reaction was innocent one. While his comment looks like unpleasant reaction, it brought or cause the expansion of the explanation for the oblique shock. However, other email that imply that someone will take care of this author aren't appreciated.

---

# To Do List and Road Map

This book isn't complete and probably never will be completed. There will always new problems to add or to polish the explanations or include more new materials. Also issues that associated with the book like the software has to be improved. It is hoped the changes in T<sub>E</sub>X and L<sup>A</sup>T<sub>E</sub>X related to this book in future will be minimal and minor. It is hoped that the style file will be converged to the final form rapidly. Nevertheless, there are specific issues which are on the "table" and they are described herein.

At this stage, many chapters are missing. Specific missing parts from every chapters are discussed below. These omissions, mistakes, approach problems are sometime appears in the book under the Meta simple like this

## Meta

sample this part.

## Meta End

You are always welcome to add a new material: problem, question, illustration or photo of experiment. Material can be further illuminate. Additional material can be provided to give a different angle on the issue at hand.

## Properties

The chapter isn't in development stage yet.

## Open Channel Flow

The chapter isn't in the development stage yet. Some parts were taken from Fundamentals of Die Casting Design book and are in a process of improvement.



---

---

# CHAPTER 1

---

## Introduction to Fluid Mechanics

### *1.1 What is Fluid Mechanics?*

Fluid mechanics deals with the study of all fluids under static and dynamic situations. Fluid mechanics is a branch of continuous mechanics which deals with a relationship between forces, motions, and static conditions in a continuous material. This study area deals with many and diversified problems such as surface tension, fluid statics, flow in enclosed bodies, or flow around bodies (solid or otherwise), flow stability, etc. In fact, almost any action a person is doing involves some kind of a fluid mechanics problem. Furthermore, the boundary between the solid mechanics and fluid mechanics is some kind of gray shed and not a sharp distinction (see Figure 1.1 for the complex relationships between the different branches which only part of it should be drawn in the same time.). For example, glass appears as a solid material, but a closer look reveals that the glass is a liquid with a large viscosity. A proof of the glass “liquidity” is the change of the glass thickness in high windows in European Churches after hundred years. The bottom part of the glass is thicker than the top part. Materials like sand (some call it quick sand) and grains should be treated as liquids. It is known that these materials have the ability to drown people. Even material such as aluminum just below the mushy zone<sup>1</sup> also behaves as a liquid similarly to butter. Furthermore, material particles that “behaves” as solid mixed with liquid creates a mixture that behaves as a complex<sup>2</sup> liquid. After it was established that the boundaries of fluid mechanics aren’t sharp, most of the discussion in this book is limited to simple and (mostly) Newtonian (sometimes power fluids) fluids which will be defined later.

The fluid mechanics study involve many fields that have no clear boundaries between them. Researchers distinguish between orderly flow and chaotic flow as the

---

<sup>1</sup>Mushy zone zone refers to to aluminum alloy with partially solid and partially liquid phases.

<sup>2</sup>It can be viewed as liquid solid multiphase flow.

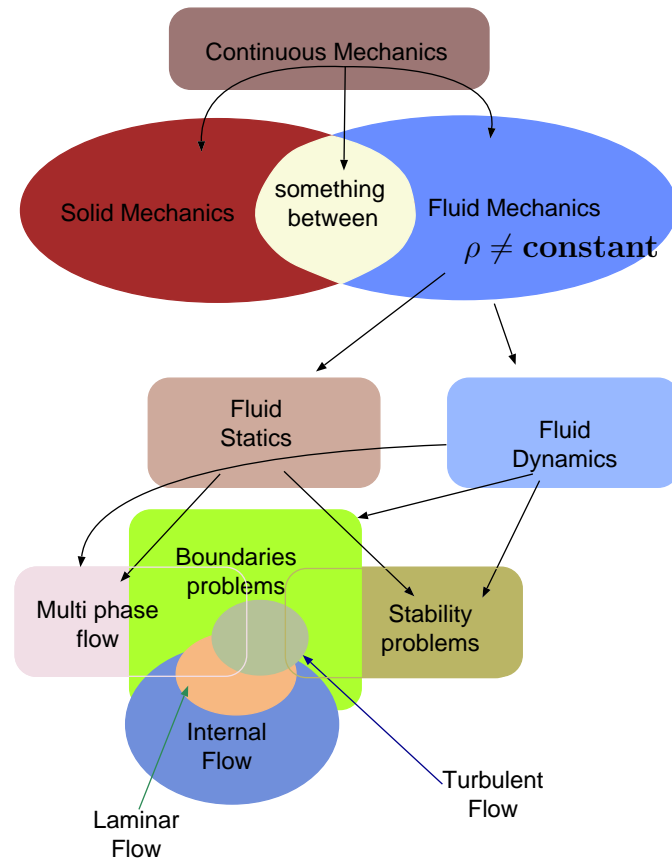

Fig. -1.1. Diagram to explain part of relationships of fluid mechanics branches.

laminar flow and the turbulent flow. The fluid mechanics can also be distinguish between a single phase flow and multiphase flow (flow made more than one phase or single distinguishable material). The last boundary (as all the boundaries in fluid mechanics) isn't sharp because fluid can go through a phase change (condensation or evaporation) in the middle or during the flow and switch from a single phase flow to a multi phase flow. Moreover, flow with two phases (or materials) can be treated as a single phase (for example, air with dust particle).

After it was made clear that the boundaries of fluid mechanics aren't sharp, the study must make arbitrary boundaries between fields. Then the dimensional analysis can be used explain why in certain cases one distinguish area/principle is more relevant than the other and some effects can be neglected. Or, when a general model is need because more parameters are effecting the situation. It is this author's personal experience that the knowledge and ability to know in what area the situation



lay is one of the main problems. For example, engineers in software company (EKK Inc, <http://ekkin.com/HTML> ) analyzed a flow of a complete still liquid assuming a complex turbulent flow model. Such absurd analysis are common among engineers who do not know which model can be applied. Thus, one of the main goals of this book is to explain what model should be applied. Before dealing with the boundaries, the simplified private cases must be explained.

There are two main approaches of presenting an introduction of fluid mechanics materials. The first approach introduces the fluid kinematic and then the basic governing equations, to be followed by stability, turbulence, boundary layer and internal and external flow. The second approach deals with the Integral Analysis to be followed with Differential Analysis, and continue with Empirical Analysis. These two approaches pose a dilemma to anyone who writes an introductory book for the fluid mechanics. These two approaches have justifications and positive points. Reviewing many books on fluid mechanics made it clear, there isn't a clear winner. This book attempts to find a hybrid approach in which the kinematic is presented first (aside to standard initial four chapters) follow by Integral analysis and continued by Differential analysis. The ideal flow (frictionless flow) should be expanded compared to the regular treatment. This book is unique in providing chapter on multiphase flow. Naturally, chapters on open channel flow (as a sub class of the multiphase flow) and compressible flow (with the latest developments) are provided.

## 1.2 *Brief History*

The need to have some understanding of fluid mechanics started with the need to obtain water supply. For example, people realized that wells have to be dug and crude pumping devices need to be constructed. Later, a large population created a need to solve waste (sewage) and some basic understanding was created. At some point, people realized that water can be used to move things and provide power. When cities increased to a larger size, aqueducts were constructed. These aqueducts reached their greatest size and grandeur in those of the City of Rome and China.

Yet, almost all knowledge of the ancients can be summarized as application of instincts, with the exception Archimedes (250 B.C.) on the principles of buoyancy. For example, larger tunnels built for a larger water supply, etc. There were no calculations even with the great need for water supply and transportation. The first progress in fluid mechanics was made by Leonardo Da Vinci (1452-1519) who built the first chambered canal lock near Milan. He also made several attempts to study the flight (birds) and developed some concepts on the origin of the forces. After his initial work, the knowledge of fluid mechanics (hydraulic) increasingly gained speed by the contributions of Galileo, Torricelli, Euler, Newton, Bernoulli family, and D'Alembert. At that stage theory and experiments had some discrepancy. This fact was acknowledged by D'Alembert who stated that, "The theory of fluids must necessarily be based upon experiment." For example the concept of ideal liquid that leads to motion with no resistance, conflicts with the reality.

This discrepancy between theory and practice is called the "D'Alembert para-

dox” and serves to demonstrate the limitations of theory alone in solving fluid problems. As in thermodynamics, two different schools of thought were created: the first believed that the solution will come from theoretical aspect alone, and the second believed that solution is the pure practical (experimental) aspect of fluid mechanics. On the theoretical side, considerable contribution were made by Euler, La Grange, Helmholtz, Kirchhoff, Rayleigh, Rankine, and Kelvin. On the “experimental” side, mainly in pipes and open channels area, were Brahm, Bossut, Chezy, Dubuat, Fabre, Coulomb, Dupuit, d’Aubisson, Hagen, and Poiseuille.

In the middle of the nineteenth century, first Navier in the molecular level and later Stokes from continuous point of view succeeded in creating governing equations for real fluid motion. Thus, creating a matching between the two schools of thought: experimental and theoretical. But, as in thermodynamics, people cannot relinquish control. As results it created today “strange” names: Hydrodynamics, Hydraulics, Gas Dynamics, and Aeronautics.

The Navier-Stokes equations, which describes the flow (or even Euler equations), were considered unsolvable during the mid nineteenth century because of the high complexity. This problem led to two consequences. Theoreticians tried to simplify the equations and arrive at approximated solutions representing specific cases. Examples of such work are Hermann von Helmholtz’s concept of vortices (1858), Lanchester’s concept of circulatory flow (1894), and the Kutta-Joukowski circulation theory of lift (1906). The experimentalists, at the same time proposed many correlations to many fluid mechanics problems, for example, resistance by Darcy, Weisbach, Fanning, Ganguillet, and Manning. The obvious happened without theoretical guidance, the empirical formulas generated by fitting curves to experimental data (even sometime merely presenting the results in tabular form) resulting in formulas that the relationship between the physics and properties made very little sense.

At the end of the twenty century, the demand for vigorous scientific knowledge that can be applied to various liquids as opposed to formula for every fluid was created by the expansion of many industries. This demand coupled with new several novel concepts like the theoretical and experimental researches of Reynolds, the development of dimensional analysis by Rayleigh, and Froude’s idea of the use of models change the science of the fluid mechanics. Perhaps the most radical concept that effects the fluid mechanics is of Prandtl’s idea of boundary layer which is a combination of the modeling and dimensional analysis that leads to modern fluid mechanics. Therefore, many call Prandtl as the father of modern fluid mechanics. This concept leads to mathematical basis for many approximations. Thus, Prandtl and his students Blasius, von Karman, Meyer, and Blasius and several other individuals as Nikuradse, Rose, Taylor, Bhuckingham, Stanton, and many others, transformed the fluid mechanics to today modern science.

While the understanding of the fundamentals did not change much, after World War Two, the way how it was calculated changed. The introduction of the computers during the 60s and much more powerful personal computer has changed the field. There are many open source programs that can analyze many fluid mechanics situations. Today many problems can be analyzed by using the numerical tools and provide reasonable

results. These programs in many cases can capture all the appropriate parameters and adequately provide a reasonable description of the physics. However, there are many other cases that numerical analysis cannot provide any meaningful result (trends). For example, no weather prediction program can produce good engineering quality results (where the snow will fall within 50 kilometers accuracy. Building a car with this accuracy is a disaster). In the best scenario, these programs are as good as the input provided. Thus, assuming turbulent flow for still flow simply provides erroneous results (see for example, EKK, Inc).

### 1.3 Kinds of Fluids

Some differentiate fluid from solid by the reaction to shear stress. It is a known fact said that the fluid continuously and permanently deformed under shear stress while solid exhibits a finite deformation which does not change with time. It is also said that fluid cannot return to their original state after the deformation. This differentiation leads to three groups of materials: solids and liquids. This test creates a new material group that shows dual behaviors; under certain limits; it behaves like solid and under others it behaves like fluid (see Figure 1.1). The study of this kind of material called rheology and it will (almost) not be discussed in this book. It is evident from this discussion that when a fluid is at rest, no shear stress is applied.

The fluid is mainly divided into two categories: liquids and gases. The main difference between the liquids and gases state is that gas will occupy the whole volume while liquids has an almost fix volume. This difference can be, for most practical purposes considered, sharp even though in reality this difference isn't sharp. The difference between a gas phase to a liquid phase above the critical point are practically minor. But below the critical point, the change of water pressure by 1000% only change the volume by less than 1 percent. For example, a change in the volume by more 5% will required tens of thousands percent change of the pressure. So, if the change of pressure is significantly less than that, then the change of volume is at best 5%. Hence, the pressure will not affect the volume. In gaseous phase, any change in pressure directly affects the volume. The gas fills the volume and liquid cannot. Gas has no free interface/surface (since it does fill the entire volume).

There are several quantities that have to be addressed in this discussion. The first is **force** which was reviewed in physics. The unit used to measure is [N]. It must be remember that force is a vector, e.g it has a direction. The second quantity discussed here is the area. This quantity was discussed in physics class but here it has an additional meaning, and it is referred to the direction of the area. The direction of area is perpendicular to the area. The area is measured in [ $m^2$ ]. Area of three-dimensional object has no single direction. Thus, these kinds of areas should be addressed infinitesimally and locally.

The traditional quantity, which is force per area has a new meaning. This is a result of division of a vector by a vector and it is referred to as tensor. In this book, the emphasis is on the physics, so at this stage the tensor will have to be broken into its components. Later, the discussion on the mathematical meaning is presented

(later version). For the discussion here, the pressure has three components, one in the area direction and two perpendicular to the area. The pressure component in the area direction is called pressure (great way to confuse, isn't it?). The other two components are referred as the shear stresses. The units used for the pressure components is  $[N/m^2]$ .

The density is a property which requires that liquid to be continuous. The density can be changed and it is a function of time and space (location) but must have a continuous property. It doesn't mean that a sharp and abrupt change in the density cannot occur. It referred to the fact that density is independent of the sampling size. Figure 1.2 shows the density as a function of the sample size. After certain sample size, the density remains constant. Thus, the density is defined as

$$\rho = \lim_{\Delta V \rightarrow \epsilon} \frac{\Delta m}{\Delta V} \quad (1.1)$$

It must be noted that  $\epsilon$  is chosen so that the continuous assumption is not broken, that is, it did not reach/reduced to the size where the atoms or molecular statistical calculations are significant (see Figure 1.2 for point where the green lines converge to constant density). When this assumption is broken, then, the principles of statistical mechanics must be utilized.

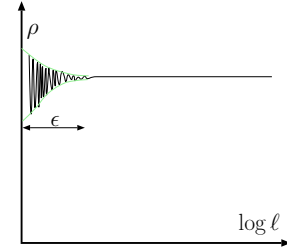

Fig. -1.2. Density as a function of the size of sample.

## 1.4 Shear Stress

The shear stress is part of the pressure tensor. However, here, and many parts of the book, it will be treated as a separate issue. In solid mechanics, the shear stress is considered as the ratio of the force acting on area in the direction of the forces perpendicular to area. Different from solid, fluid cannot pull directly but through a solid surface. Consider liquid that undergoes a shear stress between a short distance of two plates as shown in Figure (1.3).

The upper plate velocity generally will be

$$U = f(A, F, h) \quad (1.2)$$

Where  $A$  is the area, the  $F$  denotes the force,  $h$  is the distance between the plates. From solid mechanics study, it was shown that when the force per area increases, the velocity of the plate increases also. Experiments show that the increase of height will increase the velocity up to a certain range. Consider moving the plate with a zero lubricant ( $h \sim 0$ ) (results in large force) or a large amount of lubricant (smaller force). In this discussion, the aim is to develop differential equation, thus the small distance analysis is applicable.

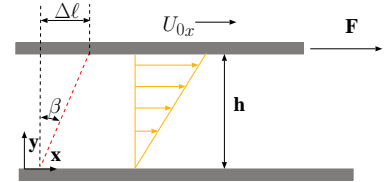

Fig. -1.3. Schematics to describe the shear stress in fluid mechanics.

For cases where the dependency is linear, the following can be written

$$U \propto \frac{hF}{A} \tag{1.3}$$

Equations (1.3) can be rearranged to be

$$\frac{U}{h} \propto \frac{F}{A} \tag{1.4}$$

Shear stress was defined as

$$\tau_{xy} = \frac{F}{A} \tag{1.5}$$

The index  $x$  represent the “direction of the shear stress while the  $y$  represent the direction of the area(perpendicular to the area). From equations (1.4) and (1.5) it follows that ratio of the velocity to height is proportional to shear stress. Hence, applying the coefficient to obtain a new equality as

$$\tau_{xy} = \mu \frac{U}{h} \tag{1.6}$$

Where  $\mu$  is called the absolute viscosity or dynamic viscosity which will be discussed later in this chapter in a great length.

In steady state, the distance the upper plate moves after small amount of time,  $\delta t$  is

$$d\ell = U \delta t \tag{1.7}$$

From Figure 1.4 it can be noticed that for a small angle,  $\delta\beta \cong \sin \beta$ , the regular approximation provides

$$d\ell = U \delta t = \overbrace{h \delta\beta}^{\text{geometry}} \tag{1.8}$$

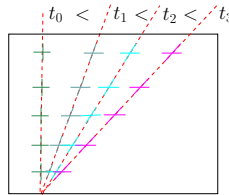

Fig. -1.4. The deformation of fluid due to shear stress as progression of time.

From equation (1.8) it follows that

$$U = h \frac{\delta\beta}{\delta t} \tag{1.9}$$

Combining equation (1.9) with equation (1.6) yields

$$\tau_{xy} = \mu \frac{\delta\beta}{\delta t} \tag{1.10}$$

If the velocity profile is linear between the plate (it will be shown later that it is consistent with derivations of velocity), then it can be written for small a angel that

$$\frac{\delta\beta}{\delta t} = \frac{dU}{dy} \tag{1.11}$$

Materials which obey equation (1.10) referred to as Newtonian fluid. For this kind of substance

$$\tau_{xy} = \mu \frac{dU}{dy} \quad (1.12)$$

Newtonian fluids are fluids which the ratio is constant. Many fluids fall into this category such as air, water etc. This approximation is appropriate for many other fluids but only within some ranges.

Equation (1.9) can be interpreted as momentum in the  $x$  direction transferred into the  $y$  direction. Thus, the viscosity is the resistance to the flow (flux) or the movement. The property of viscosity, which is exhibited by all fluids, is due to the existence of cohesion and interaction between fluid molecules. These cohesion and interactions hamper the flux in  $y$ -direction. Some referred to shear stress as viscous flux of  $x$ -momentum in the  $y$ -direction. The units of shear stress are the same as flux per time as following

$$\frac{F}{A} \left[ \frac{kg \ m}{sec^2 \ m^2} \right] = \frac{\dot{m} U}{A} \left[ \frac{kg \ m}{sec \ sec \ m^2} \right]$$

Thus, the notation of  $\tau_{xy}$  is easier to understand and visualize. In fact, this interpretation is more suitable to explain the molecular mechanism of the viscosity. The units of absolute viscosity are  $[N \ sec/m^2]$ .

Example 1.1:

*A space of 1 [cm] width between two large plane surfaces is filled with glycerin. Calculate the force that is required to drag a very thin plate of 1 [m<sup>2</sup>] at a speed of 0.5 m/sec. It can be assumed that the plates remains in equidistant from each other and steady state is achieved instantly.*

SOLUTION

Assuming Newtonian flow, the following can be written (see equation (1.6))

$$F = \frac{A \mu U}{h} \sim \frac{1 \times 1.069 \times 0.5}{0.01} = 53.45[N]$$

---

End Solution

Example 1.2:

*Castor oil at 25°C fills the space between two concentric cylinders of 0.2[m] and 0.1[m] diameters with height of 0.1 [m]. Calculate the torque required to rotate the inner cylinder at 12 rpm, when the outer cylinder remains stationary. Assume steady state conditions.*

SOLUTION

The velocity is

$$U = r \dot{\theta} = 2 \pi r_i \text{ rps} = 2 \times \pi \times 0.1 \times \overbrace{12/60}^{\text{rps}} = 0.4 \pi r_i$$

Where  $rps$  is revolution per second.

The same way as in example (1.1), the moment can be calculated as the force times the distance as

$$M = F \ell = \frac{\overbrace{\ell}^{r_i} \overbrace{2 \pi r_i h}^A \mu U}{r_o - r_i}$$

In this case  $r_o - r_i = h$  thus,

$$M = \frac{2 \pi^2 \overbrace{0.1^3}^{r_i} \overbrace{0.986}^{\mu} 0.4}{h} \sim .0078 [N m]$$

End Solution

## 1.5 Viscosity

### 1.5.1 General

Viscosity varies widely with temperature. However, temperature variation has an opposite effect on the viscosities of liquids and gases. The difference is due to their fundamentally different mechanism creating viscosity characteristics. In gases, molecules are sparse and cohesion is negligible, while in the liquids, the molecules are more compact and cohesion is more dominant. Thus, in gases, the exchange of momentum between layers brought as a result of

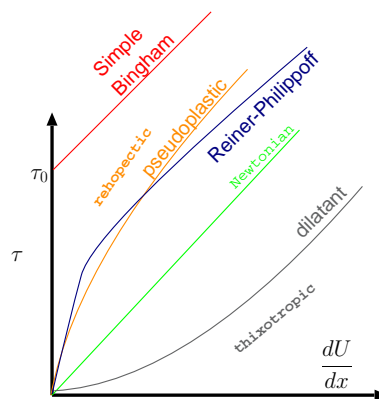

Fig. -1.5. The different of power fluids families.

molecular movement normal to the general direction of flow, and it resists the flow. This molecular activity is known to increase with temperature, thus, the viscosity of gases will increase with temperature. This reasoning is a result of the considerations of the kinetic theory. This theory indicates that gas viscosities vary directly with the square root of temperature. In liquids, the momentum exchange due to molecular movement is small compared to the cohesive forces between the molecules. Thus, the viscosity is primarily dependent on the magnitude of these cohesive forces. Since these forces decrease rapidly with increases of temperature, liquid viscosities decrease as temperature increases.

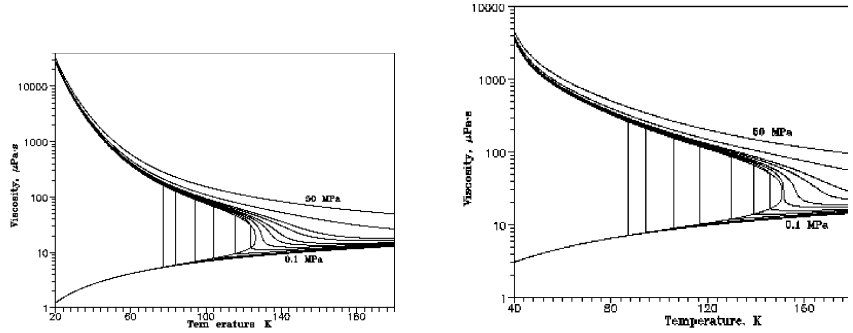

Fig. -1.6. Nitrogen (left) and Argon (right) viscosity as a function of the temperature and pressure after Lemmon and Jacobsen.

Figure 1.6 demonstrates that viscosity increases slightly with pressure, but this variation is negligible for most engineering problems. Well above the critical point, both phases are only a function of the temperature. On the liquid side below the critical point, the pressure has minor effect on the viscosity. It must be stress that the viscosity in the dome is meaningless. There is no such a thing of viscosity at 30% liquid. It simply depends on the structure of the flow as will be discussed in the chapter on multi phase flow. The lines in the above diagrams are only to show constant pressure lines. Oils have the greatest increase of viscosity with pressure which is a good thing for many engineering purposes.

### 1.5.2 Non-Newtonian Fluids

In equation (1.5), the relationship between the velocity and the shear stress was assumed to be linear. Not all the materials obey this relationship. There is a large class of materials which shows a non-linear relationship with velocity for any shear stress. This class of materials can be approximated by a single polynomial term that is  $a = bx^n$ . From the physical point of view, the coefficient depends on the velocity gradient. This relationship is referred to as power relationship and it can be written as

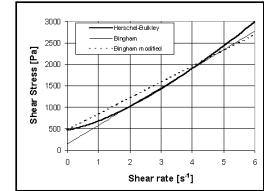

Fig. -1.7. The shear stress as a function of the shear rate.

$$\tau = K \overbrace{\left(\frac{dU}{dx}\right)^{n-1}}^{\text{viscosity}} \left(\frac{dU}{dx}\right) \tag{1.13}$$

The new coefficients ( $n, K$ ) in equation (1.13) are constant. When  $n = 1$  equation represent Newtonian fluid and  $K$  becomes the familiar  $\mu$ . The viscosity coefficient is



always positive. When  $n$ , is above one, the liquid is dilatant. When  $n$  is below one, the fluid is pseudoplastic. The liquids which satisfy equation (1.13) are referred to as purely viscous fluids. Many fluids satisfy the above equation. Fluids that show increase in the viscosity (with increase of the shear) referred to as thixotropic and those that show decrease are called reoplectic fluids (see Figure 1.5).

Materials which behave up to a certain shear stress as a solid and above it as a liquid are referred to as Bingham liquids. In the simple case, the "liquid side" is like Newtonian fluid for large shear stress. The general relationship for simple Bingham flow is

$$\tau_{xy} = -\mu \pm \tau_0 \quad \text{if } |\tau_{yx}| > \tau_0 \quad (1.14)$$

$$\frac{dU_x}{dy} = 0 \quad \text{if } |\tau_{yx}| < \tau_0 \quad (1.15)$$

There are materials that simple Bingham model does not provide adequate explanation and a more sophisticated model is required. The Newtonian part of the model has to be replaced by power liquid. For example, according to Ferraris et al<sup>3</sup> concrete behaves as shown in Figure 1.7. However, for most practical purposes, this kind of figures isn't used in regular engineering practice.

### 1.5.3 Kinematic Viscosity

The kinematic viscosity is another way to look at the viscosity. The reason for this new definition is that some experimental data are given in this form. These results also explained better using the new definition. The kinematic viscosity embraces both the viscosity and density properties of a fluid. The above equation shows that the dimensions of  $\nu$  to be square meter per second,  $[m^2/sec]$ , which are acceleration units (a combination of kinematic terms). This fact explains the name "kinematic" viscosity. The kinematic viscosity is defined as

$$\nu = \frac{\mu}{\rho} \quad (1.16)$$

The gas density decreases with the temperature. However, The increase of the absolute viscosity with the temperature is enough to overcome the increase of density and thus, the kinematic viscosity also increase with the temperature for many materials.

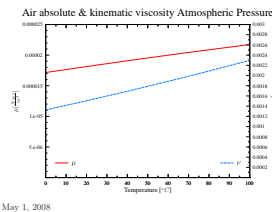

Fig. -1.8. Air viscosity as a function of the temperature.

<sup>3</sup>C. Ferraris, F. de Larrard and N. Martys, Materials Science of Concrete VI, S. Mindess and J. Skalny, eds., 215-241 (2001)

### 1.5.4 Estimation of The Viscosity

The absolute viscosity of many fluids relatively doesn't change with the pressure but very sensitive to temperature. For isothermal flow, the viscosity can be considered constant in many cases. The variations of air and water as a function of the temperature at atmospheric pressure are plotted in Figures 1.8 and 1.9.

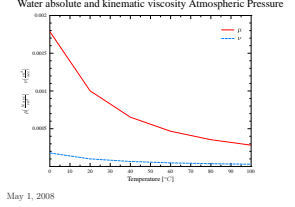

Fig. -1.9. Water viscosity as a function temperature.

Some common materials (pure and mixture) have expressions that provide an estimate. For many gases, Sutherland's equation is used and according to the literature, provides reasonable results<sup>4</sup> for the range of  $-40^{\circ}C$  to  $1600^{\circ}C$ .

$$\mu = \mu_0 \frac{0.555 T_{i0} + Suth}{0.555 T_{in} + Suth} \left( \frac{T}{T_0} \right)^{\frac{3}{2}} \tag{1.17}$$

Where

Example 1.3:

Calculate the viscosity of air at 800K based on Sutherland's equation. Use the data provide in Table 1.1.

SOLUTION

Applying the constants from Suthelnd's table provides

$$\mu = 0.00001827 \times \frac{0.555 \times 524.07 + 120}{0.555 \times 800 + 120} \times \left( \frac{800}{524.07} \right)^{\frac{3}{2}} \sim 2.51 \cdot 10^{-5} \left[ \frac{N \cdot sec}{m^2} \right]$$

The viscosity increases almost by 40%. The observed viscosity is about  $\sim 3.710^{-5} \left[ \frac{N \cdot sec}{m^2} \right]$ .

End Solution

Table -1.3. Viscosity of selected liquids.

Chemical component	Chemical formula	Temperature $T [^{\circ}C]$	Viscosity $\left[ \frac{N \cdot sec}{m^2} \right]$
--------------------	------------------	-----------------------------	--

<sup>4</sup>This author is ambivalent about this statement.

Table -1.3. Viscosity of selected liquids (continue)

Chemical component	Chemical formula	Temperature $T [^{\circ}C]$	Viscosity [ $\frac{N \cdot sec}{m^2}$ ]
	$(C_2H_5)_2O$	20	0.000245
	$C_6H_6$	20	0.000647
	$Br_2$	26	0.000946
	$C_2H_5OH$	20	0.001194
	$Hg$	25	0.001547
	$H_2SO_4$	25	0.01915
Olive Oil		25	0.084
Castor Oil		25	0.986
Clucose		25	5-20
Corn Oil		20	0.072
SAE 30		-	0.15-0.200
SAE 50		$\sim 25^{\circ}C$	0.54
SAE 70		$\sim 25^{\circ}C$	1.6
Ketchup		$\sim 20^{\circ}C$	0,05
Ketchup		$\sim 25^{\circ}C$	0,098
Benzene		$\sim 20^{\circ}C$	0.000652
Firm glass		-	$\sim 1 \times 10^7$
Glycerol		20	1.069

**Liquid Metals**

Liquid metal can be considered as a Newtonian fluid for many applications. Furthermore, many aluminum alloys are behaving as a Newtonian liquid until the first solidification appears (assuming steady state thermodynamics properties). Even when there is a solidification (mushy zone), the metal behavior can be estimated as a Newtonian material (further reading can be done in this author’s book “Fundamentals of Die Casting Design”). Figure 1.10 exhibits several liquid metals (from The Reactor Handbook, Vol. Atomic Energy Commission AECD-3646 U.S. Government Printing Office, Washington D.C. May 1995 p. 258.)

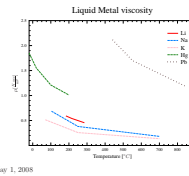

Fig. -1.10. Liquid metals viscosity as a function of the temperature.

**The General Viscosity Graphs**

Material	coefficients	Chemical formula	Sutherland	$T_{iO}[K]$	$\mu_0(N\ sec/m^2)$
ammonia		$NH_3$	370	527.67	0.00000982
standard air			120	524.07	0.00001827
carbon dioxide		$CO_2$	240	527.67	0.00001480
carbon monoxide		$CO$	118	518.67	0.00001720
hydrogen		$H_2$	72	528.93	0.0000876
nitrogen		$N_2$	111	540.99	0.0001781
oxygen		$O_2$	127	526.05	0.0002018
sulfur dioxide		$SO_2$	416	528.57	0.0001254

Table -1.1. The list for Sutherland's equation coefficients for selected materials.

Substance	Chemical formula	Temperature $T [^{\circ}C]$	Viscosity [ $\frac{N\ sec}{m^2}$ ]
	$i - C_4 H_{10}$	23	0.0000076
	$CH_4$	20	0.0000109
	$CO_2$	20	0.0000146
oxygen	$O_2$	20	0.0000203
mercury vapor	$Hg$	380	0.0000654

Table -1.2. Viscosity of selected gases.

Chemical component	Molecular Weight	$T_c$ [K]	$P_c$ [Bar]	$\mu_c$ [ $\frac{N \text{ sec}}{m^2}$ ]
$H_2$	2.016	33.3	12.9696	3.47
$He$	4.003	5.26	2.289945	2.54
$Ne$	20.183	44.5	27.256425	15.6
$Ar$	39.944	151	48.636	26.4
$Xe$	131.3	289.8	58.7685	49.
Air "mixed"	28.97	132	36.8823	19.3
$CO_2$	44.01	304.2	73.865925	19.0
$O_2$	32.00	154.4	50.358525	18.0
$C_2H_6$	30.07	305.4	48.83865	21.0
$CH_4$	16.04	190.7	46.40685	15.9
Water		647.096 K	22.064 [MPa]	

Table -1.4. The properties at the critical stage and their values of selected materials.

In case "ordinary" fluids where information is limit, Hougen et al suggested to use graph similar to compressibility chart. In this graph, if one point is well documented, other points can be estimated. Furthermore, this graph also shows the trends. In Figure 1.11 the relative viscosity  $\mu_r = \mu/\mu_c$  is plotted as a function of relative temperature,  $T_r$ .  $\mu_c$  is the viscosity at critical condition and  $\mu$  is the viscosity at any given condition. The lines of constant relative pressure,  $P_r = P/P_c$  are drawn. The lower pressure is, for practical purpose,  $\sim 1$ [bar].

The critical pressure can be evaluated in the following three ways. The simplest way is by obtaining the data from Table 1.4 or similar information. The second way, if the information is available and is close enough to the critical point, then the critical viscosity is obtained as

$$\mu_c = \frac{\overbrace{\mu}^{\text{given}}}{\underbrace{\mu_r}} \quad (1.18)$$

Figure 1.11

The third way, when none is available, is by utilizing the following approximation

$$\mu_c = \sqrt{M T_c \tilde{v}_c^{2/3}} \quad (1.19)$$

Where  $\tilde{v}_c$  is the critical molecular volume and  $M$  is molecular weight. Or

$$\mu_c = \sqrt{M P_c^{2/3} T_c^{-1/6}} \quad (1.20)$$

Calculate the reduced pressure and the reduced temperature and from the Figure 1.11 obtain the reduced viscosity.

Example 1.4:

Estimate the viscosity of oxygen,  $O_2$  at  $100^\circ C$  and  $20$ [Bar].

SOLUTION

The critical condition of oxygen are  $P_c = 50.35[\text{Bar}]$ ,  $T_c = 154.4$  and therefore  $\mu_c = 18 \left[ \frac{\text{N sec}}{\text{m}^2} \right]$  The value of the reduced temperature is

$$T_r \sim \frac{373.15}{154.4} \sim 2.41$$

The value of the reduced pressure is

$$P_r \sim \frac{20}{50.35} \sim 0.4$$

From Figure 1.11 it can be obtained  $\mu_r \sim 1.2$  and the predicted viscosity is

$$\mu = \mu_c \overbrace{\left( \frac{\mu}{\mu_c} \right)}^{\text{Table}} = 18 \times 1.2 = 21.6[\text{N sec}/\text{m}^2]$$

The observed value is  $24[\text{N sec}/\text{m}^2]^5$ .

---

End Solution

---

**Viscosity of Mixtures**

In general the viscosity of liquid mixture has to be evaluated experimentally. Even for homogeneous mixture, there isn't silver bullet to estimate the viscosity. In this book, only the mixture of low density gases is discussed for analytical expression. For most cases, the following Wilke's correlation for gas at low density provides a result in a reasonable range.

$$\mu_{mix} = \sum_{i=1}^n \frac{x_i \mu_i}{\sum_{j=1}^n x_j \Phi_{ij}} \quad (1.21)$$

where  $\Phi_{ij}$  is defined as

$$\Phi_{ij} = \frac{1}{\sqrt{8}} \sqrt{1 + \frac{M_i}{M_j}} \left( 1 + \sqrt{\frac{\mu_i}{\mu_j}} \sqrt{\frac{M_j}{M_i}} \right)^2 \quad (1.22)$$

Here,  $n$  is the number of the chemical components in the mixture.  $x_i$  is the mole fraction of component  $i$ , and  $\mu_i$  is the viscosity of component  $i$ . The subscript  $i$  should be used for the  $j$  index. The dimensionless parameter  $\Phi_{ij}$  is equal to one when  $i = j$ . The mixture viscosity is highly nonlinear function of the fractions of the components.

**Example 1.5:**

*Calculate the viscosity of a mixture (air) made of 20% oxygen,  $O_2$  and 80% nitrogen  $N_2$  for the temperature of  $20^\circ\text{C}$ .*

<sup>5</sup>Kyama, Makita, Rev. Physical Chemistry Japan Vol. 26 No. 2 1956.

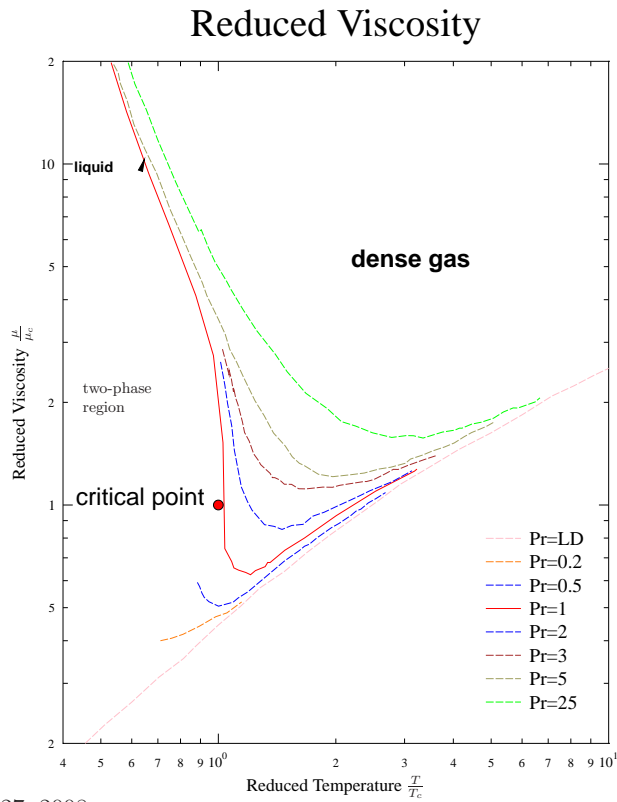
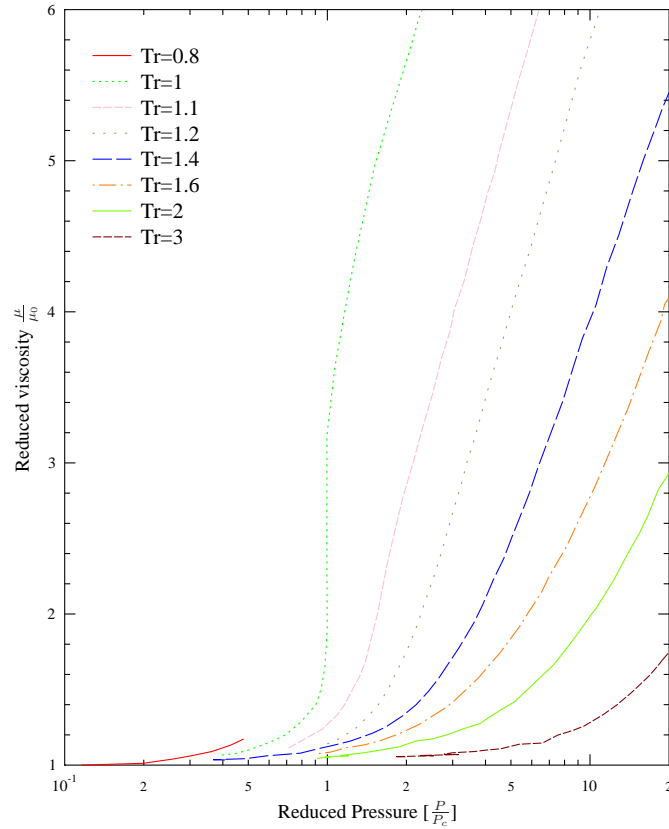

Fig. -1.11. Reduced viscosity as function of the reduced temperature.

SOLUTION

The following table summarize the known details

i	Component	Molecular Weight, $M$	Mole Fraction, $x$	Viscosity, $\mu$
1	$O_2$	32.	0.2	0.0000203
2	$N_2$	28.	0.8	0.00001754



June 2, 2008

Fig. -1.12. Reduced viscosity as function of the reduced temperature.

i	j	$M_i/M_j$	$\mu_i/\mu_j$	$\Phi_{ij}$
1	1	1.0	1.0	1.0
	2	1.143	1.157	1.0024
2	1	0.875	.86	0.996
	2	1.0	1.0	1.0

$$\mu_{mix} \sim \frac{0.2 \times 0.0000203}{0.2 \times 1.0 + 0.8 \times 1.0024} + \frac{0.8 \times 0.00001754}{0.2 \times 0.996 + 0.8 \times 1.0} \sim 0.0000181 \left[ \frac{N \cdot sec}{m^2} \right]$$

The observed value is  $\sim 0.0000182 \left[ \frac{N \cdot sec}{m^2} \right]$ .

---

End Solution



In very low pressure, in theory, the viscosity is only a function of the temperature with a “simple” molecular structure. For gases with very long molecular structure or complexity structure these formulas cannot be applied. For some mixtures of two liquids it was observed that at a low shear stress, the viscosity is dominated by a liquid with high viscosity and at high shear stress to be dominated by a liquid with the low viscosity liquid. The higher viscosity is more dominate at low shear stress. Reiner and Phillippoff suggested the following formula

$$\frac{dU_x}{dy} = \left( \frac{1}{\mu_\infty + \frac{\mu_0 - \mu_\infty}{1 + \left(\frac{\tau_{xy}}{\tau_s}\right)^2}} \right) \tau_{xy} \quad (1.23)$$

Where the term  $\mu_\infty$  is the experimental value at high shear stress. The term  $\mu_0$  is the experimental viscosity at shear stress approaching zero. The term  $\tau_s$  is the characteristic shear stress of the mixture. An example for values for this formula, for Molten Sulfur at temperature  $120^\circ C$  are  $\mu_\infty = 0.0215 \left(\frac{N \text{ sec}}{m^2}\right)$ ,  $\mu_0 = 0.00105 \left(\frac{N \text{ sec}}{m^2}\right)$ , and  $\tau_s = 0.0000073 \left(\frac{kN}{m^2}\right)$ . This equation (1.23) provides reasonable value only up to  $\tau = 0.001 \left(\frac{kN}{m^2}\right)$ .

Figure 1.12 can be used for a crude estimate of dense gases mixture. To estimate the viscosity of the mixture with  $n$  component Hougen and Watson's method for pseudocritical properties is adapted. In this method the following are defined as mixed critical pressure as

$$P_{c_{mix}} = \sum_{i=1}^n x_i P_{c_i} \quad (1.24)$$

the mixed critical temperature is

$$T_{c_{mix}} = \sum_{i=1}^n x_i T_{c_i} \quad (1.25)$$

and the mixed critical viscosity is

$$\mu_{c_{mix}} = \sum_{i=1}^n x_i \mu_{c_i} \quad (1.26)$$

Example 1.6:

An inside cylinder with a radius of 0.1 [m] rotates concentrically within a fixed cylinder of 0.101 [m] radius and the cylinders length is 0.2 [m]. It is given that a moment of 1 [N × m] is required to maintain an angular velocity of 31.4 revolution per second (these number represent only academic question not real value of actual liquid). Estimate the liquid viscosity used between the cylinders.

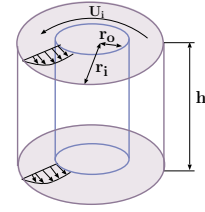

Fig. -1.13. Concentrating cylinders with the rotating inner cylinder.

### SOLUTION

The moment or the torque is transmitted through the liquid to the outer cylinder. Control volume around the inner cylinder shows that moment is a function of the area and shear stress. The shear stress calculations can be estimated as a linear between the two concentric cylinders. The velocity at the inner cylinders surface is

$$U_i = r\omega = 0.1 \times 31.4[\text{rad/second}] = 3.14[\text{m/s}] \quad (1.VI.a)$$

The velocity at the outer cylinder surface is zero. The velocity gradient may be assumed to be linear, hence,

$$\frac{dU}{dr} \cong \frac{0.1 - 0}{0.101 - 0.1} = 100\text{sec}^{-1} \quad (1.VI.b)$$

The used moment is

$$M = \underbrace{2\pi r_i h}_A \underbrace{\mu \frac{dU}{dr}}_{\tau} \underbrace{r_i}_{\ell} \quad (1.VI.c)$$

or the viscosity is

$$\mu = \frac{M}{2\pi r_i^2 h \frac{dU}{dr}} = \frac{1}{2 \times \pi \times 0.1^2 \times 0.2 \times 100} = \quad (1.VI.d)$$

End Solution

### Example 1.7:

A square block weighing 1.0 [kN] with a side surfaces area of 0.1 [m<sup>2</sup>] slides down an incline surface with an angle of 20° C. The surface is covered with oil film. The oil creates a distance between the block and the inclined surface of 1 × 10<sup>-6</sup> [m]. What is the speed of the block at steady state? Assuming a linear velocity profile in the oil and that the whole oil is under steady state. The viscosity of the oil is 3 × 10<sup>-5</sup> [m<sup>2</sup>/sec].

### SOLUTION

The shear stress at the surface is estimated for steady state by

$$\tau = \mu \frac{dU}{dx} = 3 \times 10^{-5} \times \frac{U}{1 \times 10^{-6}} = 30U \quad (1.VII.a)$$

The total friction force is then

$$f = \tau A = 0.1 \times 30U = 3U \quad (1.VII.b)$$

The gravity force that acting against the friction is equal to the friction hence

$$F_g = f = 3U \implies U = \frac{mg \sin 20^\circ}{3} \quad (1.VII.c)$$

Or the solution is

$$U = \frac{1 \times 9.8 \times \sin 20^\circ}{3} \quad (1.VII.d)$$

---

End Solution

---

Example 1.8:

Develop an expression to estimate of the torque required to rotate a disc in a narrow gap. The edge effects can be neglected. The gap is given and equal to  $\delta$  and the rotation speed is  $\omega$ . The shear stress can be assumed to be linear.

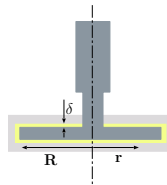

Fig. -1.14. Rotating disc in a steady state.

SOLUTION

In this cases the shear stress is a function of the radius,  $r$  and an expression has to be developed. Additionally, the differential area also increases and is a function of  $r$ . The shear stress can be estimated as

$$\tau \cong \mu \frac{U}{\delta} = \mu \frac{\omega r}{\delta} \quad (1.VIII.a)$$

This torque can be integrated for the entire area as

$$T = \int_0^R r \tau dA = \int_0^R \underbrace{r}_{\ell} \underbrace{\mu \frac{\omega r}{\delta}}_{\tau} \underbrace{2\pi r dr}_{dA} \quad (1.VIII.b)$$

The results of the integration is

$$T = \frac{\pi \mu \omega R^4}{2 \delta} \quad (1.VIII.c)$$

---

End Solution

---

## 1.6 Fluid Properties

The fluids have many properties which are similar to solid. A discussion of viscosity and surface tension should be part of this section but because special importance these topics have separate sections. The rest of the properties lumped into this section.

### 1.6.1 Fluid Density

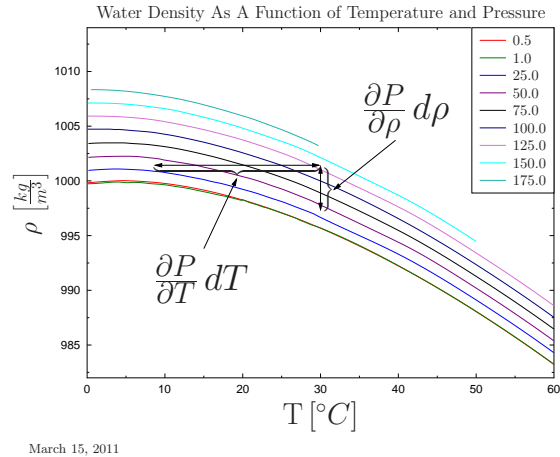

Fig. -1.15. Water density as a function of temperature for various pressure. This figure illustrates the typical situations like the one that appear in Example 1.9

The density is a property that is simple to analyzed and understand. The density is related to the other state properties such temperature and pressure through the equation of state or similar. Examples to describe the usage of property are provided.

#### Example 1.9:

A steel tank filled with water undergoes heating from  $10^{\circ}\text{C}$  to  $50^{\circ}\text{C}$ . The initial pressure can be assumed to atmospheric. Due to the change temperature the tank, (strong steel structure) undergoes linear expansion of  $8 \times 10^{-6}$  per  $^{\circ}\text{C}$ . Calculate the pressure at the end of the process.  $E$  denotes the Young's modulus<sup>6</sup>. Assume that the Young modulus of the water is  $2.15 \times 10^9 (\text{N}/\text{m}^2)$ <sup>7</sup>. State your assumptions.

#### SOLUTION

The expansion of the steel tank will be due to two contributions: one due to the thermal expansion and one due to the pressure increase in the tank. For this example, it is assumed that the expansion due to pressure change is negligible. The tank volume change under the assumptions state here but in the same time the tank walls remain

<sup>6</sup>The definition of Young's modulus is  $E = \frac{\sigma}{\epsilon}$  where in this case  $\sigma$  can be estimated as the pressure change. The definition of  $\epsilon$  is the ratio length change to total length  $\Delta L/L$ .

<sup>7</sup>This value is actually of Bulk modulus.

straight. The new density is

$$\rho_2 = \frac{\rho_1}{\underbrace{(1 + \alpha \Delta T)^3}_{\text{thermal expansion}}} \quad (1.IX.a)$$

The more accurate calculations require looking into the steam tables. As estimated value of the density using Young's modulus and  $V_2 \propto (L_2)^3$ <sup>8</sup>.

$$\rho_2 \propto \frac{1}{(L_2)^3} \implies \rho_2 \cong \frac{m}{\left(L_1 \left(1 - \frac{\Delta P}{E}\right)\right)^3} \quad (1.IX.b)$$

It can be noticed that  $\rho_1 \cong m/L_1^3$  and thus

$$\frac{\rho_1}{(1 + \alpha \Delta T)^3} = \frac{\rho_1}{\left(1 - \frac{\Delta P}{E}\right)^3} \quad (1.IX.c)$$

The change is then

$$1 + \alpha \Delta T = 1 - \frac{\Delta P}{E} \quad (1.IX.d)$$

Thus the final pressure is

$$P_2 = P_1 - E \alpha \Delta T \quad (1.IX.e)$$

In this case, what happen when the value of  $P_1 - E \alpha \Delta T$  becomes negative or very very small? The basic assumption falls and the water evaporates.

If the expansion of the water is taken into account then the change (increase) of water volume has to be taken into account. The tank volume was calculated earlier and since the claim of "strong" steel the volume of the tank is only effected by the temperature.

$$\left. \frac{V_2}{V_1} \right|_{\text{tank}} = (1 + \alpha \Delta T)^3 \quad (1.IX.f)$$

The volume of the water undergoes also a change and is a function of the temperature and pressure. The water pressure at the end of the process is unknown but the volume is known. Thus, the density at end is also known

$$\rho_2 = \frac{m_w}{T_2|_{\text{tank}}} \quad (1.IX.g)$$

The pressure is a function volume and the temperature  $P = P(v, T)$  thus

$$dP = \overbrace{\left(\frac{\partial P}{\partial v}\right)}^{\sim \beta_v} dv + \overbrace{\left(\frac{\partial P}{\partial T}\right)}^{\sim E} dT \quad (1.IX.h)$$

<sup>8</sup>This leads  $E(L_2 - L_1) = \Delta P L_1$ . Thus,  $L_2 = L_1(1 - \Delta P/E)$

As approximation it can written as

$$\Delta P = \beta_v \Delta v + E \Delta T \quad (1.IX.i)$$

Substituting the values results for

$$\Delta P = \frac{0.0002}{\Delta \rho} + 2.15 \times 10^9 \Delta T \quad (1.IX.j)$$

Notice that density change,  $\Delta \rho < 0$ .

---

End Solution

---

### 1.6.2 Bulk Modulus

Similar to solids (hook's law), liquids have a property that describes the volume change as results of pressure change for constant temperature. It can be noted that this property is not the result of the equation of state but related to it. Bulk modulus is usually obtained from experimental or theoretical or semi theoretical (theory with experimental work) to fit energy–volume data. Most (theoretical) studies are obtained by uniformly changing the unit cells in global energy variations especially for isotropic systems ( where the molecules has a structure with cubic symmetries). The bulk modulus is a measure of the energy can be stored in the liquid. This coefficient is analogous to the coefficient of spring. The reason that liquid has different coefficient is because it is three dimensional verse one dimension that appear in regular spring.

The bulk modulus is defined as

$$B_T = -v \left( \frac{\partial P}{\partial v} \right)_T \quad (1.27)$$

Using the identity of  $v = 1/\rho$  transfers equation (1.27) into

$$B_T = \rho \left( \frac{\partial P}{\partial \rho} \right)_T \quad (1.28)$$

The bulk modulus for several selected liquids is presented in Table 1.5.

Table -1.5. The bulk modulus for selected material with the critical temperature and pressure *na* → not available and *n.f* → not found (exist but was not found in the literature).

Chemical component	Bulk Modulus $10^9 \frac{N}{m}$	$T_c$	$P_c$
Acetic Acid	2.49	593K	57.8 [Bar]
Acetone	0.80	508 K	48 [Bar]
Benzene	1.10	562 K	4.74 [MPa]
Carbon Tetrachloride	1.32	556.4 K	4.49 [MPa]

Table -1.5. Bulk modulus for selected materials (continue)

Chemical component	Bulk Modulus $10^9 \frac{N}{m}$	$T_c$	$P_c$
Ethyl Alcohol	1.06	514 K	6.3 [Mpa]
Gasoline	1.3	nf	nf
Glycerol	4.03-4.52	850 K	7.5 [Bar]
Mercury	26.2-28.5	1750 K	172.00 [MPa]
Methyl Alcohol	0.97	Est 513	Est 78.5 [Bar]
Nitrobenzene	2.20	nf	nf
Olive Oil	1.60	nf	nf
Paraffin Oil	1.62	nf	nf
SAE 30 Oil	1.5	na	na
Seawater	2.34	na	na
Toluene	1.09	591.79 K	4.109 [MPa]
Turpentine	1.28	na	na
Water	2.15-2.174	647.096 K	22.064 [MPa]

In the literature, additional expansions for similar parameters are defined. The thermal expansion is defined as

$$\beta_P = \frac{1}{v} \left( \frac{\partial v}{\partial T} \right)_P \quad (1.29)$$

This parameter indicates the change of volume due to temperature change when the pressure is constant. Another definition is referred as coefficient of tension and it is defined as

$$\beta_v = \frac{1}{P} \left( \frac{\partial P}{\partial T} \right)_v \quad (1.30)$$

This parameter indicates the change of the pressure due to the change of temperature (where  $v = \text{constant}$ ). These definitions are related to each other. This relationship is obtained by the observation that the pressure as a function of the temperature and specific volume as

$$P = f(T, v) \quad (1.31)$$

The full pressure derivative is

$$dP = \left( \frac{\partial P}{\partial T} \right)_v dT + \left( \frac{\partial P}{\partial v} \right)_T dv \quad (1.32)$$

On constant pressure lines,  $dP = 0$ , and therefore equation (1.32) reduces

$$0 = \left( \frac{\partial P}{\partial T} \right)_v dT + \left( \frac{\partial P}{\partial v} \right)_T dv \quad (1.33)$$

From equation (1.33) follows that

$$\left. \frac{dv}{dT} \right|_{P=\text{const}} = - \frac{\left( \frac{\partial P}{\partial T} \right)_v}{\left( \frac{\partial P}{\partial v} \right)_T} \quad (1.34)$$

Equation (1.34) indicates that relationship for these three coefficients is

$$\beta_T = - \frac{\beta_v}{\beta_P} \quad (1.35)$$

The last equation (1.35) sometimes is used in measurement of the bulk modulus.

The increase of the pressure increases the bulk modulus due to the molecules increase of the rejecting forces between each other when they are closer. In contrast, the temperature increase results in reduction of the bulk of modulus because the molecular are further away.

Example 1.10:

*Calculate the modulus of liquid elasticity that reduced 0.035 per cent of its volume by applying a pressure of 5[Bar] in a s slow process.*

SOLUTION

Using the definition for the bulk modulus

$$\beta_T = -v \frac{\partial P}{\partial v} \simeq \frac{v}{\Delta v} \Delta P = \frac{5}{0.00035} \simeq 14285.714[\text{Bar}]$$

---

End Solution

Example 1.11:

*Calculate the pressure needed to apply on water to reduce its volume by 1 per cent. Assume the temperature to be 20°C.*

SOLUTION

Using the definition for the bulk modulus

$$\Delta P \sim \beta_T \frac{\Delta v}{v} \sim 2.15 \cdot 10^9 \cdot 0.01 = 2.15 \cdot 10^7 [\text{N/m}^2] = 215[\text{Bar}]$$

---

End Solution

Example 1.12:



1.6. FLUID PROPERTIES

Two layers of two different liquids are contained in a very solid tank. Initially the pressure in the tank is  $P_0$ . The liquids are compressed due to the pressure increases. The new pressure is  $P_1$ . The area of the tank is  $A$  and liquid A height is  $h_1$  and liquid B height is  $h_2$ . Estimate the change of the heights of the liquids depicted in the Figure 1.16. State your assumptions.

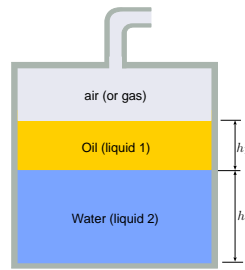

Fig. -1.16. Two liquid layers under pressure.

SOLUTION

The volume change in a liquid is

$$B_T \cong \frac{\Delta P}{\Delta V/V} \tag{1.XII.a}$$

Hence the change for the any liquid is

$$\Delta h = \frac{\Delta P}{A B_T/V} = \frac{h \Delta P}{B_T} \tag{1.XII.b}$$

The total change when the hydrostatic pressure is ignored.

$$\Delta h_{1+2} = \Delta P \left( \frac{h_1}{B_{T1}} + \frac{h_2}{B_{T2}} \right) \tag{1.XII.c}$$

---

End Solution

Example 1.13:

In the Internet the following problem ( here with  $\LaTeX$  modification) was posted which related to Pushka equation.

A cylindrical steel pressure vessel with volume  $1.31 \text{ m}^3$  is to be tested. The vessel is entirely filled with water, then a piston at one end of the cylinder is pushed in until the pressure inside the vessel has increased by 1000 kPa. Suddenly, a safety plug on the top bursts. How many liters of water come out?

Relevant equations and data suggested by the user were:  $B_T = 0.2 \times 10^{10} \text{ N/m}^2$ ,  $P_1 = P_0 + \rho g h$ ,  $P_1 = -B_T \Delta V/V$  with the suggested solution of

"I am assuming that I have to look for  $\Delta V$  as that would be the water that comes out causing the change in volume."

$$\Delta V = \frac{-V \Delta P}{B_T} = -1.31(1000)/(0.2 \times 10^{10}) \Delta V = 6.55 * 10^{-7}$$

Another user suggest that:

We are supposed to use the bulk modulus from our textbook, and that one is  $0.2 \times 10^{10}$ .

Anything else would give a wrong answer in the system. So with this bulk modulus, is 0.655L right?

In this post several assumptions were made. What is a better way to solve this problem.

#### SOLUTION

It is assumed that this process can be between two extremes: one isothermal and one isentropic. The assumption of isentropic process is applicable after a shock wave that travel in the tank. If the shock wave is ignored (too advance material for this book<sup>9</sup>), the process is isentropic. The process involve some thermodynamics identities to be connected. Since the pressure is related or a function of density and temperature it follows that

$$P = P(\rho, T) \quad (1.XIII.a)$$

Hence the full differential is

$$dP = \left. \frac{\partial P}{\partial \rho} \right|_T d\rho + \left. \frac{\partial P}{\partial T} \right|_\rho dT \quad (1.XIII.b)$$

Equation (1.XIII.b) can be multiplied by  $\rho/P$  to be

$$\frac{\rho dP}{P} = \frac{1}{P} \left( \overbrace{\rho \left. \frac{\partial P}{\partial \rho} \right|_T}^{B_T} d\rho \right) + \rho \left( \overbrace{\left. \frac{1}{P} \frac{\partial P}{\partial T} \right|_\rho}^{\beta_v} dT \right) \quad (1.XIII.c)$$

The definitions that were provided before can be used to write

$$\frac{\rho dP}{P} = \frac{1}{P} B_T d\rho + \rho \beta_v dT \quad (1.XIII.d)$$

The infinitesimal change of density will be then

$$\frac{1}{P} B_T d\rho = \frac{\rho dP}{P} - \rho \beta_v dT \quad (1.XIII.e)$$

or

$$d\rho = \frac{\rho dP}{B_T} - \frac{\rho P \beta_v dT}{B_T} \quad (1.XIII.f)$$

Thus, the calculation that were provide on line need to have corrections by subtracting the second terms.

---

End Solution

<sup>9</sup>The shock wave velocity is related to square of elasticity of the water. Thus the characteristic time for the shock is  $S/c$  when  $S$  is a typical dimension of the tank and  $c$  is speed of sound of the water in the tank.

### 1.6.2.1 Bulk Modulus of Mixtures

In the discussion above it was assumed that the liquid is pure. In this short section a discussion about the bulk modulus averaged is presented. When more than one liquid are exposed to pressure the value of these two (or more liquids) can have to be added in special way. The definition of the bulk modulus is given by equation (1.27) or (1.28) and can be written (where the partial derivative can look as delta  $\Delta$  as

$$\partial V = \frac{V \partial P}{B_T} \cong \frac{V \Delta P}{B_T} \quad (1.36)$$

The total change is compromised by the change of individual liquids or phases if two materials are present. Even in some cases of emulsion (a suspension of small globules of one liquid in a second liquid with which the first will not mix) the total change is the summation of the individuals change. In case the total change isn't, in special mixture, another approach with taking into account the energy-volume is needed. Thus, the total change is

$$\partial V = \partial V_1 + \partial V_2 + \dots + \partial V_i \cong \Delta V_1 + \Delta V_2 + \dots + \Delta V_i \quad (1.37)$$

Substituting equation (1.36) into equation (1.37) results in

$$\partial V = \frac{V_1 \partial P}{B_{T1}} + \frac{V_2 \partial P}{B_{T2}} + \dots + \frac{V_i \partial P}{B_{Ti}} \cong \frac{V_1 \Delta P}{B_{T1}} + \frac{V_2 \Delta P}{B_{T2}} + \dots + \frac{V_i \Delta P}{B_{Ti}} \quad (1.38)$$

Under the main assumption in this model the total volume is comprised of the individual volume hence,

$$V = x_1 V + x_2 V + \dots + x_i V \quad (1.39)$$

Where  $x_1$ ,  $x_2$  and  $x_i$  are the fraction volume such as  $x_i = V_i/V$ . Hence, using this identity and the fact that the pressure is change for all the phase uniformly equation (1.39) can be written as

$$\partial V = V \partial P \left( \frac{x_1}{B_{T1}} + \frac{x_2}{B_{T2}} + \dots + \frac{x_i}{B_{Ti}} \right) \cong V \Delta P \left( \frac{x_1}{B_{T1}} + \frac{x_2}{B_{T2}} + \dots + \frac{x_i}{B_{Ti}} \right) \quad (1.40)$$

Rearranging equation (1.40) yields

$$v \frac{\partial P}{\partial v} \cong v \frac{\Delta P}{\Delta v} = \frac{1}{\left( \frac{x_1}{B_{T1}} + \frac{x_2}{B_{T2}} + \dots + \frac{x_i}{B_{Ti}} \right)} \quad (1.41)$$

Equation (1.41) suggested an averaged new bulk modulus

$$B_{T_{mix}} = \frac{1}{\left( \frac{x_1}{B_{T1}} + \frac{x_2}{B_{T2}} + \dots + \frac{x_i}{B_{Ti}} \right)} \quad (1.42)$$

In that case the equation for mixture can be written as

$$v \frac{\partial P}{\partial v} = B_{Tmix} \quad (1.43)$$

10

— — — — — *End Advance material* — — — — —

### 1.6.2.2 When the Bulk Modulus is Important? and Hydraulics System

There are only several situations in which the bulk modulus is important. These situations include hydraulic systems, deep ocean (on several occasions), geology system like the Earth, Cosmology. The Pushka equation normally can address the situations in deep ocean and geological system. This author is not aware of any special issues that involve in Cosmology as opposed to geological system. The only issue that was not addressed is the effect on hydraulic systems. The hydraulic system normally refers to systems in which a liquid is used to transmit forces (pressure) for surface of moving object (normally piston) to another object. In theoretical or hypothetical liquids the moving one object (surface) results in movement of the other object under the condition that liquid volume is fix. The movement of the responsive object is unpredictable when the liquid volume or density is a function of the pressure (and temperature due to the friction). In very rapid systems the temperature and pressure varies during the operation significantly. In practical situations, the commercial hydraulic fluid can change due to friction by  $50^{\circ}\text{C}$ . The bulk modulus or the volume for the hydraulic oil changes by more 60%. The change of the bulk modulus by this amount can change the response time significantly. Hence the analysis has to take into account the above effects.

## 1.7 Surface Tension

The surface tension manifested itself by a rise or depression of the liquid at the free surface edge. Surface tension is also responsible for the creation of the drops and bubbles. It also responsible for the breakage of a liquid jet into other medium/phase to many drops (atomization). The surface tension is force per length and is measured by  $[\text{N/m}]$  and is acting to stretch the surface.

Surface tension results from a sharp change in the density between two adjoined phases or ma-

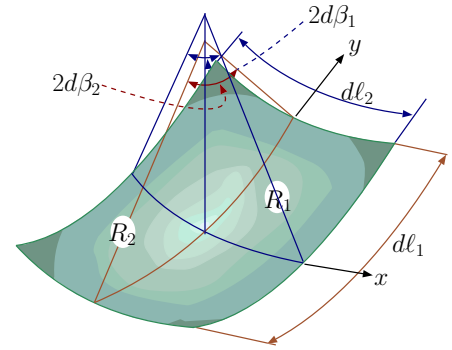

Fig. -1.17. Surface tension control volume analysis describing principles radii.

<sup>10</sup>To be added in the future the effect of change of chemical composition on bulk modulus.

materials. There is a common misconception for the source of the surface tension. In many (physics, surface tension, and fluid mechanics) books explained that the surface tension is a result from unbalanced molecular cohesive forces. This explanation is wrong since it is in conflict with Newton's second law (see Example 1.14). This erroneous explanation can be traced to Adam's book but earlier source may be found<sup>11</sup>.

Example 1.14:

In several books the following explanation is offered for surface tension. "The cohesive forces between molecules down into a liquid are shared with all neighboring atoms. Those on the surface have no neighboring atoms above, and exhibit stronger attractive forces upon their nearest neighbors on the surface. This enhancement of the intermolecular attractive forces at the surface is called<sup>12</sup>." Explain the fundamental error of this explanation (see Figure 1.18).

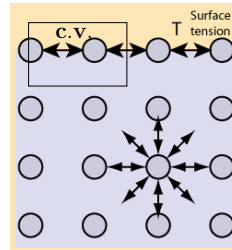

Fig. -1.18. Surface tension erroneous explanation.

#### SOLUTION

The explanation based on the imbalance of the top layer of molecules. Due to the fact that "one" molecule is pulled up by the other surrounding molecules and pulled down by the "second" layer. According to Newton's second law, this layer should move down and the liquid cannot be at rest ever. Obviously, the liquid is at rest and this explanation violates Newton's second law. In addition, it violates the thermodynamics second law as it creates a perpetual motion machine.

End Solution

The relationship between the surface tension and the pressure on the two sides of the surface is based on geometry. Consider a small element of surface. The pressure on one side is  $P_i$  and the pressure on the other side is  $P_o$ . When the surface tension is constant, the horizontal forces cancel each other because of symmetry. In the vertical direction, the surface tension forces are pulling the surface upward. Thus, the pressure difference has to balance the surface tension. The forces in the vertical direction reads

$$(P_i - P_o) dl_1 dl_2 = \Delta P dl_1 dl_2 = 2 \sigma dl_1 \sin \beta_1 + 2 \sigma dl_2 \sin \beta_2 \quad (1.44)$$

For a very small area, the angles are very small and thus  $(\sin \beta \sim \beta)$ . Furthermore, it can be noticed that  $dl_i \sim 2 R_i d\beta_i$ . Thus, the equation (1.44) can be simplified as

$$\Delta P = \sigma \left( \frac{1}{R_1} + \frac{1}{R_2} \right) \quad (1.45)$$

<sup>11</sup>Finding the source of this error was a class project early 1990 in Chemical Engineering University of Minnesota.

<sup>12</sup>This text and picture are taken from the web at the address of [hyperphysics.phy-astr.gsu.edu/hbase/surten.html](http://hyperphysics.phy-astr.gsu.edu/hbase/surten.html).

Equation (1.45) predicts that pressure difference increase with inverse of the radius. There are two extreme cases: one) radius of infinite and radius of finite size. The second with two equal radii. The first case is for an infinite long cylinder for which the equation (1.45) is reduced to

$$\Delta P = \sigma \left( \frac{1}{R} \right) \quad (1.46)$$

Other extreme is for a sphere for which the main radii are the same and equation (1.45) is reduced to

$$\Delta P = \frac{2\sigma}{R} \quad (1.47)$$

Where  $R$  is the radius of the sphere. A soap bubble is made of two layers, inner and outer, thus the pressure inside the bubble is

$$\Delta P = \frac{4\sigma}{R} \quad (1.48)$$

Example 1.15:

A glass tube is inserted into bath of mercury. It was observed that contact angle between the glass and mercury is  $55^\circ$  C.

The inner diameter is  $0.02[m]$  and the outer diameter is  $0.021[m]$ . Estimate the force due to the surface tension (tube is depicted in Figure 1.19). It can be assume that the contact angle is the same for the inside and outside part of the tube. Estimate the depression size. Assume that the surface tension for this combination of material is  $0.5 [N/m]$

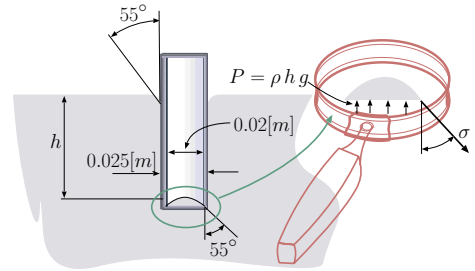

Fig. -1.19. Glass tube inserted into mercury.

#### SOLUTION

The mercury as free body that several forces act on it.

$$F = \sigma 2\pi \cos 55^\circ C (D_i + D_o) \quad (1.XV.a)$$

This force is upward and the horizontal force almost canceled. However, if the inside and the outside diameters are considerable different the results is

$$F = \sigma 2\pi \sin 55^\circ C (D_o - D_i) \quad (1.XV.b)$$

The balance of the forces on the meniscus show under the magnified glass are

$$P \overbrace{\pi r^2}^A = \sigma 2\pi r + W \sim 0 \quad (1.XV.c)$$

or

$$g \rho h \pi r^2 = \sigma 2 \pi r + W \sim 0 \quad (1.XV.d)$$

Or after simplification

$$h = \frac{2 \sigma}{g \rho r} \quad (1.XV.e)$$

---

End Solution

---

Example 1.16:

A Tank filled with liquid, which contains  $n$  bubbles with equal radii,  $r$ . Calculate the minimum work required to increase the pressure in tank by  $\Delta P$ . Assume that the liquid bulk modulus is infinity.

SOLUTION

The work is due to the change of the bubbles volume. The work is

$$w = \int_{r_0}^{r_f} \Delta P(v) dv \quad (1.49)$$

The minimum work will be for a reversible process. The reversible process requires very slow compression. It is worth noting that for very slow process, the temperature must remain constant due to heat transfer. The relationship between pressure difference and the radius is described by equation (1.47) for reversible process. Hence the work is

$$w = \int_{r_0}^{r_f} \overbrace{\frac{2 \sigma}{r}}^{\Delta P} \overbrace{4 \pi r^2 dr}^{dv} = 8 \pi \sigma \int_{r_0}^{r_f} r dr = 4 \pi \sigma (r_f^2 - r_0^2) \quad (1.50)$$

Where,  $r_0$  is the radius at the initial stage and  $r_f$  is the radius at the final stage.

The work for  $n$  bubbles is then  $4 \pi \sigma n (r_f^2 - r_0^2)$ . It can be noticed that the work is negative, that is the work is done on the system.

---

End Solution

---

Example 1.17:

Calculate the rise of liquid between two dimensional parallel plates shown in Figure 1.20. Notice that previously a rise for circular tube was developed which different from simple one dimensional case. The distance between the two plates is  $\ell$  and the surface tension is  $\sigma$ . Assume that the contact angle is  $0^{circ}$  (the maximum possible force). Compute the value for surface tension of  $0.05[N/m]$ , the density  $1000[kg/m^3]$  and distance between the plates of  $0.001[m]$ .

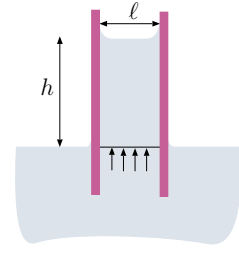

Fig. -1.20. Capillary rise between two plates.

### SOLUTION

In Figure 1.20 exhibits the liquid under the current study. The vertical forces acting on the body are the gravity, the pressure above and below and surface tension. It can be noted that the pressure and above are the same with the exception of the curvature on the upper part. Thus, the control volume is taken just above the liquid and the air part is neglected. The question when the curvature should be answered in the Dimensional analysis and for simplification this effect is neglected. The net forces in the vertical direction (positive upwards) per unit length are

$$2\sigma \cos 0^\circ = g h \ell \rho \implies h = \frac{2\sigma}{\ell \rho g} \quad (1.51)$$

Inserting the values into equation (1.51) results in

$$h = \frac{2 \times 0.05}{0.001 \times 9.8 \times 1000} = \quad (1.52)$$

End Solution

### Example 1.18:

Develop expression for rise of the liquid due to surface tension in concentric cylinders.

### SOLUTION

The difference lie in the fact that "missing" cylinder add additional force and reduce the amount of liquid that has to raise. The balance between gravity and surface tension is

$$\sigma 2\pi (r_i \cos \theta_i + r_o \cos \theta_o) = \rho g h (\pi(r_o)^2 - \pi(r_i)^2) \quad (1.XVIII.a)$$

Which can be simplified as

$$h = \frac{2\sigma (r_i \cos \theta_i + r_o \cos \theta_o)}{\rho g ((r_o)^2 - (r_i)^2)} \quad (1.XVIII.b)$$



The maximum is obtained when  $\cos \theta_i = \cos \theta_o = 1$ . Thus, equation (1.XVIII.b) can be simplified

$$h = \frac{2\sigma}{\rho g (r_o - r_i)} \tag{1.XVIII.c}$$

---

End Solution

---

### 1.7.1 Wetting of Surfaces

To explain the source of the contact angle, consider the point where three phases became in contact. This contact point occurs due to free surface reaching a solid boundary. The surface tension occurs between gas phase (G) to liquid phase (L) and also occurs between the solid (S) and the liquid phases as well as between the gas phase and the solid phase. In Figure 1.21, forces diagram is shown when control volume is chosen so that the masses of the solid, liquid, and gas can be ignored. Regardless to the magnitude of the surface tensions (except to zero) the forces cannot be balanced for the description of straight lines. For example, forces balanced along the line of solid boundary is

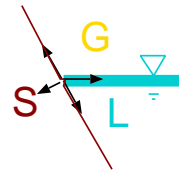

Fig. -1.21. Forces in Contact angle.

$$\sigma_{gs} - \sigma_{ls} - \sigma_{lg} \cos \beta = 0 \tag{1.53}$$

and in the tangent direction to the solid line the forces balance is

$$F_{solid} = \sigma_{lg} \sin \beta \tag{1.54}$$

substituting equation (1.54) into equation (1.53) yields

$$\sigma_{gs} - \sigma_{ls} = \frac{F_{solid}}{\tan \beta} \tag{1.55}$$

For  $\beta = \pi/2 \implies \tan \beta = \infty$ . Thus, the solid reaction force must be zero. The gas solid surface tension is different from the liquid solid surface tension and hence violating equation (1.53).

The surface tension forces must be balanced, thus, a contact angle is created to balance it. The contact angle is determined by whether the surface tension between the gas solid ( $\sigma_{gs}$ ) is larger or smaller than the surface tension of liquid solid ( $\sigma_{ls}$ ) and the local geometry. It must be noted that the solid boundary isn't straight. The surface tension is a molecular phenomenon, thus depend on the local structure of the surface and it provides the balance for these local structures.

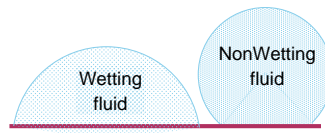

Fig. -1.22. Description of wetting and non-wetting fluids.

The connection of the three phases—materials—mediums creates two situations which are categorized as wetting or non-wetting. There is a common definition of wetting the surface. If the angle of the contact between three materials is larger than  $90^\circ$  then it is non-wetting. On the other hand, if the angle is below than  $90^\circ$  the material is wetting the surface (see Figure 1.22). The angle is determined by properties of the liquid, gas medium and the solid surface. And a small change on the solid surface can change the wetting condition to non-wetting. In fact there are commercial sprays that are intent to change the surface from wetting to non wetting. This fact is the reason that no reliable data can be provided with the exception to pure substances and perfect geometries. For example, water is described in many books as a wetting fluid. This statement is correct in most cases, however, when solid surface is made or cotted with certain materials, the water is changed to be wetting (for example 3M selling product to “change” water to non-wetting). So, the wetness of fluids is a function of the solid as well.

Table -1.6. The contact angle for air, distilled water with selected materials to demonstrate the inconsistency.

Chemical component	Contact Angle	Source
Steel	$\pi/3.7$	[1]
Steel,Nickel	$\pi/4.74$	[2]
Nickel	$\pi/4.74$ to $\pi/3.83$	[1]
Nickel	$\pi/4.76$ to $\pi/3.83$	[3]
Chrome-Nickel Steel	$\pi/3.7$	[4]
Silver	$\pi/6$ to $\pi/4.5$	[5]
Zink	$\pi/3.4$	[4]
Bronze	$\pi/3.2$	[4]
Copper	$\pi/4$	[4]
Copper	$\pi/3$	[7]
Copper	$\pi/2$	[8]

- 1 R. Siegel, E. G. Keshock (1975) “Effects of reduced gravity on nucleate boiling bubble dynamics in saturated water,” AIChE Journal Volume 10 Issue 4, Pages 509 - 517. 1975
- 2 Bergles A. E. and Rohsenow W. M. ”The determination of forced convection surface-boiling heat transfer, ASME, J. Heat Transfer, vol 1 pp 365 - 372.
- 3 Tolubinsky, V.I. and Ostrovsky, Y.N. (1966) “On the mechanism of boiling heat transfer”,. International Journal of Heat and Mass Transfer, Vol. 9, No 12, pages 1465-1470.
- 4 Arefeva E.I., Aladev O, I.T., (1958) “wlijanii smatchivaemosti na teploobmen pri

- kipenii," Injenerno Fizitcheskij Jurnal, 11-17 1(7) In Russian.
- 5 Labuntsov D. A. (1939) "Approximate theory of heat transfer by developed nucleate boiling" In Sussian Izvestiya An SSSR , Energetika I transport, No 1.
  - 6 Basu, N., Warriar, G. R., and Dhir, V. K., (2002) "Onset of Nucleate Boiling and Active Nucleation Site Density during Subcooled Flow Boiling," ASME Journal of Heat Transfer, Vol. 124, papas 717 -728.
  - 7 Gaetner, R. F., and Westwater, J. W., (1960) "Population of Active Sites in Nucleate Boiling Heat Transfer," Chem. Eng. Prog. Symp., Ser. 56.
  - 8 Wang, C. H., and Dhir, V. K., (1993), "Effect of Surface Wettability on Active Nucleation Site Density During Pool Boiling of Water on a Vertical Surface," J. Heat Transfer 115, pp. 659-669

To explain the contour of the surface, and the contact angle consider simple "wetting" liquid contacting a solid material in two-dimensional shape as depicted in Figure 1.23. To solve the shape of the liquid surface, the pressure difference between the two sides of free surface has to be balanced by the surface tension. In Figure 1.23 describes the raising of the liquid as results of the surface tension. The surface tension

reduces the pressure in the liquid above the liquid line (the dotted line in the Figure 1.23). The pressure just below the surface is  $-g h(x) \rho$  (this pressure difference will be explained in more details in Chapter 4). The pressure, on the gas side, is the atmospheric pressure. This problem is a two dimensional problem and equation (1.46) is applicable to it. Appalling equation (1.46) and using the pressure difference yields

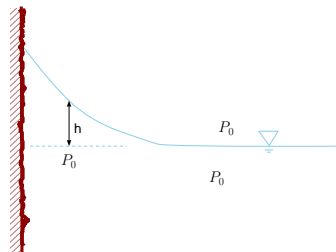

Fig. -1.23. Description of the liquid surface.

$$g h(x), \rho = \frac{\sigma}{R(x)} \quad (1.56)$$

The radius of any continuous function,  $h = h(x)$ , is

$$R(x) = \frac{\left(1 + [\dot{h}(x)]^2\right)^{3/2}}{\ddot{h}(x)} \quad (1.57)$$

Where  $\dot{h}$  is the derivative of  $h$  with respect to  $x$ .

Equation (1.57) can be derived either by forcing a circle at three points at  $(x,$

$x+dx$ , and  $x+2dx$ ) and thus finding the diameter or by geometrical analysis of triangles build on points  $x$  and  $x+dx$  (perpendicular to the tangent at these points). Substituting equation (1.57) into equation (1.56) yields

$$g h(x) \rho = \frac{\sigma}{\frac{\left(1 + \left[\dot{h}(x)\right]^2\right)^{3/2}}{\ddot{h}(x)}} \quad (1.58)$$

Equation (1.58) is non-linear differential equation for height and can be written as

**1-D Surface Due to Surface Tension**

$$\frac{g h \rho}{\sigma} \left(1 + \left[\frac{dh}{dx}\right]^2\right)^{3/2} - \frac{d^2h}{dx^2} = 0 \quad (1.59)$$

With the boundary conditions that specify either the derivative  $\dot{h}(x=r) = 0$  (symmetry) and the derivative at  $\dot{h}x = \beta$  or heights in two points or other combinations. An alternative presentation of equation (1.58) is

$$g h \rho = \frac{\sigma \ddot{h}}{\left(1 + \dot{h}^2\right)^{3/2}} \quad (1.60)$$

Integrating equation (1.60) transforms into

$$\int \frac{g \rho}{\sigma} h dh = \int \frac{\ddot{h}}{\left(1 + \dot{h}^2\right)^{3/2}} dh \quad (1.61)$$

The constant  $Lp\sigma/\rho g$  is referred to as Laplace's capillarity constant. The units of this constant are meter squared. The differential  $dh$  is  $\dot{h}$ . Using dummy variable and the identities  $\dot{h} = \xi$  and hence,  $\ddot{h} = \dot{\xi} = d\xi$  transforms equation (1.61) into

$$\int \frac{1}{Lp} h dh = \int \frac{\xi d\xi}{\left(1 + \xi^2\right)^{3/2}} \quad (1.62)$$

After the integration equation (1.62) becomes

$$\frac{h^2}{2Lp} + constant = -\frac{1}{\left(1 + \dot{h}^2\right)^{1/2}} \quad (1.63)$$

At infinity, the height and the derivative of the height must be zero so  $constant + 0 = -1/1$  and hence,  $constant = -1$ .

$$1 - \frac{h^2}{2Lp} = \frac{1}{\left(1 + \dot{h}^2\right)^{1/2}} \quad (1.64)$$

Equation (1.64) is a first order differential equation that can be solved by variables separation<sup>13</sup>. Equation (1.64) can be rearranged to be

$$(1 + \dot{h}^2)^{1/2} = \frac{1}{1 - \frac{h^2}{2Lp}} \quad (1.65)$$

Squaring both sides and moving the one to the right side yields

$$\dot{h}^2 = \left( \frac{1}{1 - \frac{h^2}{2Lp}} \right)^2 - 1 \quad (1.66)$$

The last stage of the separation is taking the square root of both sides to be

$$\dot{h} = \frac{dh}{dx} = \sqrt{\left( \frac{1}{1 - \frac{h^2}{2Lp}} \right)^2 - 1} \quad (1.67)$$

or

$$\frac{dh}{\sqrt{\left( \frac{1}{1 - \frac{h^2}{2Lp}} \right)^2 - 1}} = dx \quad (1.68)$$

Equation (1.68) can be integrated to yield

$$\int \frac{dh}{\sqrt{\left( \frac{1}{1 - \frac{h^2}{2Lp}} \right)^2 - 1}} = x + \text{constant} \quad (1.69)$$

The constant is determined by the boundary condition at  $x = 0$ . For example if  $h(x = 0) = h_0$  then  $\text{constant} = h_0$ . This equation is studied extensively in classes on surface tension. Furthermore, this equation describes the dimensionless parameter that affects this phenomenon and this parameter will be studied in Chapter ?. This book is introductory, therefore this discussion on surface tension equation will be limited.

### 1.7.1.1 Capillarity

The capillary forces referred to the fact that surface tension causes liquid to rise or penetrate into area (volume), otherwise it will not be there. It can be shown that the height that the liquid raised in a tube due to the surface tension is

$$h = \frac{2\sigma \cos \beta}{g \Delta \rho r} \quad (1.70)$$

Where  $\Delta \rho$  is the difference of liquid density to the gas density and  $r$  is the radius of tube.

<sup>13</sup>This equation has an analytical solution which is  $x = Lp\sqrt{4 - (h/Lp)^2} - Lp \operatorname{acosh}(2Lp/h) + \text{constant}$  where  $Lp$  is the Laplace constant. Shamefully, this author doesn't know how to show it in a two lines derivations.

But this simplistic equation is unusable and useless unless the contact angle (assuming that the contact angle is constant or a repressive average can be found or provided or can be measured) is given. However, in reality there is no readily information for contact angle<sup>14</sup> and therefore this equation is useful to show the trends. The maximum that the contact angle can be obtained in equation (1.70) when  $\beta = 0$  and thus  $\cos\beta = 1$ . This angle is obtained when a perfect half a sphere shape exist of the liquid surface. In that case equation (1.70) becomes

$$h_{max} = \frac{2\sigma}{g\Delta\rho r} \quad (1.71)$$

Figure 1.25 exhibits the height as a function of the radius of the tube. The height based on equation (1.71) is shown in Figure 1.24 as blue line. The actual height is shown in the red line. Equation (1.71) provides reasonable results only in a certain range. For a small tube radius, equation (1.59) proved better results because the curve approaches hemispherical sphere (small gravity effect). For large radii equation (1.59) approaches the strait line (the liquid line) strong gravity effect. On the other hand, for extremely small radii equation (1.71) indicates that the high height which indicates a negative pressure. The liquid at a certain pressure will be vaporized and will breakdown the model upon this equation was constructed. Furthermore, the small scale indicates that the simplistic and continuous approach is not appropriate and a different model is needed. The conclusion of this discussion are shown in Figure 1.24. The actual dimension for many liquids (even water) is about 1-5 [mm]. The discussion above was referred to “wetting” contact angle. The depression of the liquid occurs in a “negative” contact angle similarly to “wetting.” The depression height,  $h$  is similar to equation (1.71) with a minus sign. However, the gravity is working against the surface tension and reducing the range and quality of the predictions of equation (1.71). The measurements of the height of distilled water and mercury are presented in Figure 1.25. The experimental results of these materials are with agreement with the discussion above.

The surface tension of a selected material is given in Table 1.7.

In conclusion, the surface tension issue is important only in case where the radius is very small and gravity is negligible. The surface tension depends on the two materials or mediums that it separates.

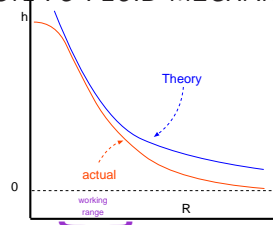
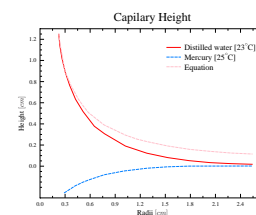

Fig. -1.24. The raising height as a function of the radii.



May 29, 2008

Fig. -1.25. The raising height as a function of the radii.

<sup>14</sup>Actually, there are information about the contact angle. However, that information conflict each other and no real information is available see Table 1.6.

Example 1.19:

Calculate the diameter of a water droplet to attain pressure difference of  $1000[N/m^2]$ . You can assume that temperature is  $20^\circ C$ .

SOLUTION

The pressure inside the droplet is given by equation (1.47).

$$D = 2R = \frac{2\sigma}{\Delta P} = \frac{4 \times 0.0728}{1000} \sim 2.912 \cdot 10^{-4} [m]$$

---

End Solution

---

Example 1.20:

Calculate the pressure difference between a droplet of water at  $20^\circ C$  when the droplet has a diameter of  $0.02 \text{ cm}$ .

SOLUTION

using equation

$$\Delta P = \frac{2\sigma}{r} \sim \frac{2 \times 0.0728}{0.0002} \sim 728.0 [N/m^2]$$

---

End Solution

---

Example 1.21:

Calculate the maximum force necessary to lift a thin wire ring of  $0.04[m]$  diameter from a water surface at  $20^\circ C$ . Neglect the weight of the ring.

SOLUTION

$$F = 2(2\pi r \sigma) \cos \beta$$

The actual force is unknown since the contact angle is unknown. However, the maximum Force is obtained when  $\beta = 0$  and thus  $\cos \beta = 1$ . Therefore,

$$F = 4\pi r \sigma = 4 \times \pi \times 0.04 \times 0.0728 \sim .0366 [N]$$

In this value the gravity is not accounted for.

---

End Solution

---

Example 1.22:

A small liquid drop is surrounded with the air and has a diameter of  $0.001 [m]$ . The pressure difference between the inside and outside droplet is  $1[kPa]$ . Estimate the surface tension?

SOLUTION

To be continue

End Solution

Table -1.7. The surface tension for selected materials at temperature 20°C when not mentioned.

Chemical component	Surface Tension $\frac{mN}{m}$	$T$	correction $\frac{mN}{mK}$
Acetic Acid	27.6	20°C	n/a
Acetone	25.20	-	-0.1120
Aniline	43.4	22°C	-0.1085
Benzene	28.88	-	-0.1291
Benzylalcohol	39.00	-	-0.0920
Benzylbenzoate	45.95	-	-0.1066
Bromobenzene	36.50	-	-0.1160
Bromobenzene	36.50	-	-0.1160
Bromoform	41.50	-	-0.1308
Butyronitrile	28.10	-	-0.1037
Carbon disulfid	32.30	-	-0.1484
Quinoline	43.12	-	-0.1063
Chloro benzene	33.60	-	-0.1191
Chloroform	27.50	-	-0.1295
Cyclohexane	24.95	-	-0.1211
Cyclohexanol	34.40	25°C	-0.0966
Cyclopentanol	32.70	-	-0.1011
Carbon Tetrachloride	26.8	-	n/a
Carbon disulfid	32.30	-	-0.1484
Chlorobutane	23.10	-	-0.1117
Ethyl Alcohol	22.3	-	n/a
Ethanol	22.10	-	-0.0832
Ethylbenzene	29.20	-	-0.1094
Ethylbromide	24.20	-	-0.1159
Ethylene glycol	47.70	-	-0.0890
Formamide	58.20	-	-0.0842
Gasoline	~ 21	-	n/a
Glycerol	64.0	-	-0.0598
Helium	0.12	-269°C	n/a
Mercury	425-465.0	-	-0.2049
Methanol	22.70	-	-0.0773
Methyl naphthalene	38.60	-	-0.1118
Methyl Alcohol	22.6	-	n/a
Neon	5.15	-247°C	n/a

Continued on next page



Table -1.7. The surface tension for selected materials (continue)

Chemical component	Surface Tension $\frac{mN}{m}$	$T$	correction $\frac{mN}{m K}$
Nitrobenzene	43.90	-	-0.1177
Olive Oil	43.0-48.0	-	-0.067
Perfluoroheptane	12.85	-	-0.0972
Perfluorohexane	11.91	-	-0.0935
Perfluorooctane	14.00	-	-0.0902
Phenylisothiocyanate	41.50	-	-0.1172
Propanol	23.70	25°C	-0.0777
Pyridine	38.00	-	-0.1372
Pyrrrol	36.60	-	-0.1100
SAE 30 Oil	n/a	-	n/a
Seawater	54-69	-	n/a
Toluene	28.4	-	-0.1189
Turpentine	27	-	n/a
Water	72.80	-	-0.1514
o-Xylene	30.10	-	-0.1101
m-Xylene	28.90	-	-0.1104



---

---

# CHAPTER 2

---

## Review of Thermodynamics

In this chapter, a review of several definitions of common thermodynamics terms is presented. This introduction is provided to bring the student back to current place with the material.

### 2.1 Basic Definitions

The following basic definitions are common to thermodynamics and will be used in this book.

#### **Work**

In mechanics, the work was defined as

$$\text{mechanical work} = \int \mathbf{F} \cdot d\mathbf{l} = \int PdV \quad (2.1)$$

This definition can be expanded to include two issues. The first issue that must be addressed, that work done on the surroundings by the system boundaries is positive. Two, there is a transfer of energy so that its effect can cause work. It must be noted that electrical current is a work while heat transfer isn't.

#### **System**

This term will be used in this book and it is defined as a continuous (at least partially) fixed quantity of matter. The dimensions of this material can be changed. In this definition, it is assumed that the system speed is significantly lower than that of the speed of light. So, the mass can be assumed constant even though the true conservation law applied to the combination of mass energy (see Einstein's law). In fact for almost all engineering purpose this law is reduced to two separate laws of mass conservation and energy conservation.

Our system can receive energy, work, etc as long the mass remain constant the definition is not broken.

### Thermodynamics First Law

This law refers to conservation of energy in a non accelerating system. Since all the systems can be calculated in a non accelerating systems, the conservation is applied to all systems. The statement describing the law is the following.

$$Q_{12} - W_{12} = E_2 - E_1 \quad (2.2)$$

The system energy is a state property. From the first law it directly implies that for process without heat transfer (adiabatic process) the following is true

$$W_{12} = E_1 - E_2 \quad (2.3)$$

Interesting results of equation (2.3) is that the way the work is done and/or intermediate states are irrelevant to final results. There are several definitions/separations of the kind of works and they include kinetic energy, potential energy (gravity), chemical potential, and electrical energy, etc. The internal energy is the energy that depends on the other properties of the system. For example for pure/homogeneous and simple gases it depends on two properties like temperature and pressure. The internal energy is denoted in this book as  $E_U$  and it will be treated as a state property.

The potential energy of the system is depended on the body force. A common body force is the gravity. For such body force, the potential energy is  $mgz$  where  $g$  is the gravity force (acceleration),  $m$  is the mass and the  $z$  is the vertical height from a datum. The kinetic energy is

$$K.E. = \frac{mU^2}{2} \quad (2.4)$$

Thus the energy equation can be written as

Total Energy Equation

$$\frac{mU_1^2}{2} + m g z_1 + E_{U1} + Q = \frac{mU_2^2}{2} + m g z_2 + E_{U2} + W \quad (2.5)$$

For the unit mass of the system equation (2.5) is transformed into

Specific Energy Equation

$$\frac{U_1^2}{2} + g z_1 + E_{u1} + q = \frac{U_2^2}{2} + g z_2 + E_{u2} + w \quad (2.6)$$

where  $q$  is the energy per unit mass and  $w$  is the work per unit mass. The "new" internal energy,  $E_u$ , is the internal energy per unit mass.

Since the above equations are true between arbitrary points, choosing any point in time will make it correct. Thus differentiating the energy equation with respect to time yields the rate of change energy equation. The rate of change of the energy transfer is

$$\frac{DQ}{Dt} = \dot{Q} \quad (2.7)$$

In the same manner, the work change rate transferred through the boundaries of the system is

$$\frac{DW}{Dt} = \dot{W} \quad (2.8)$$

Since the system is with a fixed mass, the rate energy equation is

$$\dot{Q} - \dot{W} = \frac{D E_U}{Dt} + m U \frac{DU}{Dt} + m \frac{D B_f z}{Dt} \quad (2.9)$$

For the case where the body force,  $B_f$ , is constant with time like in the case of gravity equation (2.9) reduced to

Time Dependent Energy Equation

$$\dot{Q} - \dot{W} = \frac{D E_U}{Dt} + m U \frac{DU}{Dt} + m g \frac{D z}{Dt} \quad (2.10)$$

The time derivative operator,  $D/Dt$  is used instead of the common notation because it referred to system property derivative.

### Thermodynamics Second Law

There are several definitions of the second law. No matter which definition is used to describe the second law it will end in a mathematical form. The most common mathematical form is Clausius inequality which state that

$$\oint \frac{\delta Q}{T} \geq 0 \quad (2.11)$$

The integration symbol with the circle represent integral of cycle (therefor circle) in with system return to the same condition. If there is no lost, it is referred as a reversible process and the inequality change to equality.

$$\oint \frac{\delta Q}{T} = 0 \quad (2.12)$$

The last integral can go though several states. These states are independent of the path the system goes through. Hence, the integral is independent of the path. This observation leads to the definition of entropy and designated as  $S$  and the derivative of entropy is

$$ds \equiv \left( \frac{\delta Q}{T} \right)_{\text{rev}} \quad (2.13)$$

Performing integration between two states results in

$$S_2 - S_1 = \int_1^2 \left( \frac{\delta Q}{T} \right)_{\text{rev}} = \int_1^2 dS \quad (2.14)$$

One of the conclusions that can be drawn from this analysis is for reversible and adiabatic process  $dS = 0$ . Thus, the process in which it is reversible and adiabatic, the entropy remains constant and referred to as isentropic process. It can be noted that there is a possibility that a process can be irreversible and the right amount of heat transfer to have zero change entropy change. Thus, the reverse conclusion that zero change of entropy leads to reversible process, isn't correct.

For reversible process equation (2.12) can be written as

$$\delta Q = T dS \quad (2.15)$$

and the work that the system is doing on the surroundings is

$$\delta W = P dV \quad (2.16)$$

Substituting equations (2.15) (2.16) into (2.10) results in

$$T dS = dE_U + P dV \quad (2.17)$$

Even though the derivation of the above equations were done assuming that there is no change of kinetic or potential energy, it still remain valid for all situations. Furthermore, it can be shown that it is valid for reversible and irreversible processes.

### Enthalpy

It is a common practice to define a new property, which is the combination of already defined properties, the enthalpy of the system.

$$H = E_U + P V \quad (2.18)$$

The specific enthalpy is enthalpy per unit mass and denoted as,  $h$ .

Or in a differential form as

$$dH = dE_U + dP V + P dV \quad (2.19)$$

Combining equations (2.18) the (2.17) yields

(one form of) Gibbs Equation

$$T dS = dH - V dP \quad (2.20)$$

For isentropic process, equation (2.17) is reduced to  $dH = V dP$ . The equation (2.17) in mass unit is

$$T ds = du + P dv = dh - \frac{dP}{\rho} \quad (2.21)$$

when the density enters through the relationship of  $\rho = 1/v$ .

### Specific Heats

The change of internal energy and enthalpy requires new definitions. The first change of the internal energy and it is defined as the following

$$C_v \equiv \left( \frac{\partial E_u}{\partial T} \right) \quad (2.22)$$

And since the change of the enthalpy involve some kind of work is defined as

$$C_p \equiv \left( \frac{\partial h}{\partial T} \right) \quad (2.23)$$

The ratio between the specific pressure heat and the specific volume heat is called the ratio of the specific heat and it is denoted as,  $k$ .

$$k \equiv \frac{C_p}{C_v} \quad (2.24)$$

For solid, the ratio of the specific heats is almost 1 and therefore the difference between them is almost zero. Commonly the difference for solid is ignored and both are assumed to be the same and therefore referred as  $C$ . This approximation less strong for liquid but not by that much and in most cases it applied to the calculations. The ratio the specific heat of gases is larger than one.

### Equation of state

Equation of state is a relation between state variables. Normally the relationship of temperature, pressure, and specific volume define the equation of state for gases. The simplest equation of state referred to as ideal gas. And it is defined as

$$P = \rho R T \quad (2.25)$$

Application of Avogadro's law, that "all gases at the same pressures and temperatures have the same number of molecules per unit of volume," allows the calculation of a "universal gas constant." This constant to match the standard units results in

$$\bar{R} = 8.3145 \frac{kJ}{kmol K} \quad (2.26)$$

Thus, the specific gas can be calculate as

$$R = \frac{\bar{R}}{M} \quad (2.27)$$

The specific constants for select gas at 300K is provided in table 2.1.

Table -2.1. Properties of Various Ideal Gases [300K]

Gas	Chemical Formula	Molecular Weight	$R \left[ \frac{kJ}{KgK} \right]$	$C_P \left[ \frac{kJ}{KgK} \right]$	$C_v \left[ \frac{kJ}{KgK} \right]$	$k$
Air	-	28.970	0.28700	1.0035	0.7165	1.400
Argon	Ar	39.948	0.20813	0.5203	0.3122	1.667
Butane	$C_4H_{10}$	58.124	0.14304	1.7164	1.5734	1.091
Carbon Dioxide	$CO_2$	44.01	0.18892	0.8418	0.6529	1.289
Carbon Monoxide	$CO$	28.01	0.29683	1.0413	0.7445	1.400
Ethane	$C_2H_6$	30.07	0.27650	1.7662	1.4897	1.186
Ethylene	$C_2H_4$	28.054	0.29637	1.5482	1.2518	1.237
Helium	He	4.003	2.07703	5.1926	3.1156	1.667
Hydrogen	$H_2$	2.016	4.12418	14.2091	10.0849	1.409
Methane	$CH_4$	16.04	0.51835	2.2537	1.7354	1.299
Neon	Ne	20.183	0.41195	1.0299	0.6179	1.667
Nitrogen	$N_2$	28.013	0.29680	1.0416	0.7448	1.400
Octane	$C_8H_{18}$	114.230	0.07279	1.7113	1.6385	1.044
Oxygen	$O_2$	31.999	0.25983	0.9216	0.6618	1.393
Propane	$C_3H_8$	44.097	0.18855	1.6794	1.4909	1.126
Steam	$H_2O$	18.015	0.48152	1.8723	1.4108	1.327

From equation (2.25) of state for perfect gas it follows

$$d(Pv) = R dT \quad (2.28)$$

For perfect gas

$$dh = dE_u + d(Pv) = dE_u + d(RT) = f(T) \text{ (only)} \quad (2.29)$$

From the definition of enthalpy it follows that

$$d(Pv) = dh - dE_u \quad (2.30)$$



Utilizing equation (2.28) and substituting into equation (2.30) and dividing by  $dT$  yields

$$C_p - C_v = R \quad (2.31)$$

This relationship is valid only for ideal/perfect gases.

The ratio of the specific heats can be expressed in several forms as

$C_v$  to Specific Heats Ratio

$$C_v = \frac{R}{k - 1} \quad (2.32)$$

$C_p$  to Specific Heats Ratio

$$C_p = \frac{k R}{k - 1} \quad (2.33)$$

The specific heat ratio,  $k$  value ranges from unity to about 1.667. These values depend on the molecular degrees of freedom (more explanation can be obtained in Van Wylen "F. of Classical thermodynamics." The values of several gases can be approximated as ideal gas and are provided in Table (2.1).

The entropy for ideal gas can be simplified as the following

$$s_2 - s_1 = \int_1^2 \left( \frac{dh}{T} - \frac{dP}{\rho T} \right) \quad (2.34)$$

Using the identities developed so far one can find that

$$s_2 - s_1 = \int_1^2 C_p \frac{dT}{T} - \int_1^2 \frac{R dP}{P} = C_p \ln \frac{T_2}{T_1} - R \ln \frac{P_2}{P_1} \quad (2.35)$$

Or using specific heat ratio equation (2.35) transformed into

$$\frac{s_2 - s_1}{R} = \frac{k}{k - 1} \ln \frac{T_2}{T_1} - \ln \frac{P_2}{P_1} \quad (2.36)$$

For isentropic process,  $\Delta s = 0$ , the following is obtained

$$\ln \frac{T_2}{T_1} = \ln \left( \frac{P_2}{P_1} \right)^{\frac{k-1}{k}} \quad (2.37)$$

There are several famous identities that results from equation (2.37) as

Ideal Gas Isentropic Relationships

$$\frac{T_2}{T_1} = \left( \frac{P_2}{P_1} \right)^{\frac{k-1}{k}} = \left( \frac{V_1}{V_2} \right)^{k-1} \quad (2.38)$$

The ideal gas model is a simplified version of the real behavior of real gas. The real gas has a correction factor to account for the deviations from the ideal gas model. This correction factor referred as the compressibility factor and defined as

Z deviation from the Ideal Gas Model

$$Z = \frac{PV}{RT}$$

(2.39)

---



---

# CHAPTER 3

---

## Review of Mechanics

*This author would like to express his gratitude to Dan Olsen (former Minneapolis city Engineer) and his friend Richard Hackbarth.*

This chapter provides a review of important definitions and concepts from Mechanics (statics and dynamics). These concepts and definitions will be used in this book and a review is needed.

### 3.1 Kinematics of of Point Body

A point body is location at time,  $t$  in a location,  $\vec{R}$ . The velocity is derivative of the change of the location and using the chain rule (for the direction and one for the magnitude) results,

$$\vec{U} = \frac{d\vec{R}}{dt} = \underbrace{\left. \frac{d\vec{R}}{dt} \right|_R}_{\text{change in } R \text{ direction}} + \underbrace{\vec{\omega} \times \vec{R}}_{\text{change in perpendicular to } R} \quad (3.1)$$

Notice that  $\vec{\omega}$  can have three dimensional components. It also can be noticed that this derivative is present derivation of any victory. The acceleration is the derivative of the velocity

$$\vec{a} = \frac{d\vec{U}}{dt} = \underbrace{\left. \frac{d^2\vec{R}}{dt^2} \right|_R}_{\text{"regular acceleration"}} + \underbrace{\left( \vec{R} \times \frac{d\vec{\omega}}{dt} \right)}_{\text{angular acceleration}} + \underbrace{\vec{\omega} \times \left( \vec{R} \times \vec{\omega} \right)}_{\text{centrifugal acceleration}} + 2 \underbrace{\left( \left. \frac{d\vec{R}}{dt} \right|_R \times \vec{\omega} \right)}_{\text{Coriolis acceleration}} \quad (3.2)$$

Example 3.1:

*A water jet is supposed be used to extinguish the fire in a building as depicted in Figure*

3.1<sup>1</sup>. For given velocity, at what angle the jet has to be shot so that velocity will be horizontal at the window. Assume that gravity is  $g$  and the distance of the nozzle from the building is  $a$  and height of the window from the nozzle is  $b$ . To simplify the calculations, it proposed to calculate the velocity of the point particle to toward the window. Calculate what is the velocity so that the jet reach the window. What is the angle that jet has to be aimed.

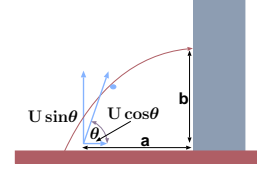

Fig. -3.1. Description of the extinguish nozzle aimed at the building window.

#### SOLUTION

The initial velocity is unknown and denoted as  $U$  which two components. The velocity at  $x$  is  $U_x = U \cos \theta$  and the velocity in  $y$  direction is  $U_y = U \sin \theta$ . There there are three unknowns,  $U$ ,  $\theta$ , and time,  $t$  and three equations. The equation for the  $x$  coordinate is

$$a = U \cos \theta t \quad (3.1.a)$$

The distance for  $y$  equation for coordinate (zero is at the window) is

$$0 = -\frac{gt^2}{2} + U \sin \theta t - b \quad (3.1.b)$$

The velocity for the  $y$  coordinate at the window is zero

$$u(t) = 0 = -gt + U \sin \theta \quad (3.1.c)$$

These nonlinear equations (3.1.a), (3.1.b) and (3.1.c) can be solved explicitly. Isolating  $t$  from (3.1.a) and substituting into equations (3.1.b) and (3.1.c)

$$b = \frac{-ga^2}{2U^2 \cos^2 \theta} + a \tan \theta \quad (3.1.d)$$

and equation (3.1.a) becomes

$$0 = \frac{-ga}{U \cos \theta} + U \cos \theta \implies U = \frac{\sqrt{ag}}{\cos \theta} \quad (3.1.e)$$

Substituting (3.1.e) into (3.1.d) results in

$$\tan \theta = \frac{b}{a} + \frac{1}{2} \quad (3.1.f)$$

End Solution

<sup>1</sup>While the simple example does not provide exact use of the above equation it provides experience of going over the motions of kinematics.

## 3.2 Center of Mass

The center of mass is divided into two sections, first, center of the mass and two, center of area (two-dimensional body with equal distribution mass).

### 3.2.1 Actual Center of Mass

In many engineering problems, the knowledge of center of mass is required to make the calculations. This concept is derived from the fact that a body has a center of mass/gravity which interacts with other bodies and that this force acts on the center (equivalent force). It turns out that this concept is very useful in calculating rotations, moment of inertia, etc. The center of mass doesn't depend on the coordinate system and on the way it is calculated. The physical meaning of the center of mass is that if a straight line force acts on the body in away through the center of gravity, the body will not rotate. In other words, if a body will be held by one point it will be enough to hold the body in the direction of the center of mass. Note, if the body isn't be held through the center of mass, then a moment in additional to force is required (to prevent the body for rotating). It is convenient to use the Cartesian system to explain this concept. Suppose that the body has a distribution of the mass (density, *rho*) as a function of the location. The density "normally" defined as mass per volume. Here, the the line density is referred to density mass per unit length in the *x* direction.

In *x* coordinate, the center will be defined as

$$\bar{x} = \frac{1}{m} \int_V x \overbrace{\rho(x) dV}^{dm} \quad (3.3)$$

Here, the  $dV$  element has finite dimensions in *y*-*z* plane and infinitesimal dimension in *x* direction see Figure 3.2. Also, the mass, *m* is the total mass of the object. It can be noticed that center of mass in the *x*-direction isn't affected by the distribution in the *y* nor by *z* directions. In same fashion the center of mass can be defined in the other directions as following

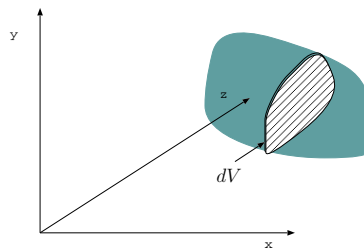

Fig. -3.2. Description of how the center of mass is calculated.

$$\bar{x}_i = \frac{1}{m} \int_V x_i \rho(x_i) dV \quad (3.4)$$

where  $x_i$  is the direction of either, *x*, *y* or *z*. The density,  $\rho(x_i)$  is the line density as function of  $x_i$ . Thus, even for solid and uniform density the line density is a function of the geometry.

### 3.2.2 Approximate Center of Area

In the previous case, the body was a three dimensional shape. There are cases where the body can be approximated as a two-dimensional shape because the body is with a thin with uniform density. Consider a uniform thin body with constant thickness shown in Figure 3.3 which has density,  $\rho$ . Thus, equation (3.3) can be transferred into

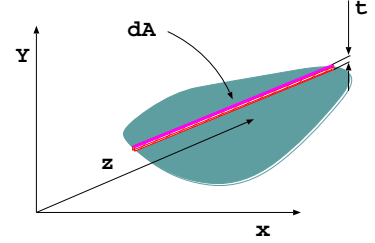

Fig. -3.3. Thin body center of mass/area schematic.

$$\bar{x} = \frac{1}{\underbrace{tA}_V} \rho \int_V x \overbrace{\rho t dA}^{dm} \quad (3.5)$$

The density,  $\rho$  and the thickness,  $t$ , are constant and can be canceled. Thus equation (3.5) can be transferred into

Aproxiate  $x_i$  of Center Mass

$$\bar{x}_i = \frac{1}{A} \int_A x_i dA \quad (3.6)$$

when the integral now over only the area as oppose over the volume.

Finding the centroid location should be done in the most convenient coordinate system since the location is coordinate independent.

## 3.3 Moment of Inertia

As it was divided for the body center of mass, the moment of inertia is divided into moment of inertia of mass and area.

### 3.3.1 Moment of Inertia for Mass

The moment of inertia turns out to be an essential part for the calculations of rotating bodies. Furthermore, it turns out that the moment of inertia has much wider applicability. Moment of inertia of mass is defined as

Moment of Inertia

$$I_{rrm} = \int_m \rho r^2 dm \quad (3.7)$$

If the density is constant then equation (3.7) can be transformed into

$$I_{rrm} = \rho \int_V r^2 dV \quad (3.8)$$

The moment of inertia is independent of the coordinate system used for the calculation, but dependent on the location of axis of rotation relative to the body. Some people define the radius of gyration as an equivalent concepts for the center of mass concept and which means if all the mass were to locate in the one point/distance and to obtain the same of moment of inertia.

$$r_k = \sqrt{\frac{I_m}{m}} \tag{3.9}$$

The body has a different moment of inertia for every coordinate/axis and they are

$$\begin{aligned} I_{xx} &= \int_V r_x^2 dm = \int_V (y^2 + z^2) dm \\ I_{yy} &= \int_V r_y^2 dm = \int_V (x^2 + z^2) dm \\ I_{zz} &= \int_V r_z^2 dm = \int_V (x^2 + y^2) dm \end{aligned} \tag{3.10}$$

### 3.3.2 Moment of Inertia for Area

#### 3.3.2.1 General Discussion

For body with thickness,  $t$  and uniform density the following can be written

$$I_{xxm} = \int_m r^2 dm = \rho t \overbrace{\int_A r^2 dA}^{\text{moment of inertia for area}} \tag{3.11}$$

The moment of inertia about axis is  $x$  can be defined as

**Moment of Inertia**

$$I_{xx} = \int_A r^2 dA = \frac{I_{xxm}}{\rho t} \tag{3.12}$$

where  $r$  is distance of  $dA$  from the axis  $x$  and  $t$  is the thickness.

Any point distance can be calculated from axis  $x$  as

$$r = \sqrt{y^2 + z^2} \tag{3.13}$$

Thus, equation (3.12) can be written as

$$I_{xx} = \int_A (y^2 + z^2) dA \tag{3.14}$$

In the same fashion for other two coordinates as

$$I_{yy} = \int_A (x^2 + z^2) dA \tag{3.15}$$

$$I_{zz} = \int_A (x^2 + y^2) dA \tag{3.16}$$

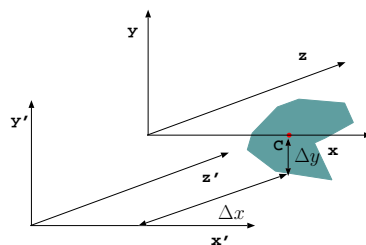

Fig. -3.4. The schematic that explains the summation of moment of inertia.

### 3.3.2.2 The Parallel Axis Theorem

The moment of inertia can be calculated for any axis. The knowledge about one axis can help calculating the moment of inertia for a parallel axis. Let  $I_{xx}$  the moment of inertia about axis  $xx$  which is at the center of mass/area.

The moment of inertia for axis  $x'$  is

$$I_{x'x'} = \int_A r'^2 dA = \int_A (y'^2 + z'^2) dA = \int_A [(y + \Delta y)^2 + (z + \Delta z)^2] dA \quad (3.17)$$

equation (3.17) can be expanded as

$$I_{x'x'} = \overbrace{\int_A (y^2 + z^2) dA}^{I_{xx}} + \overbrace{2 \int_A (y \Delta y + z \Delta z) dA}^{=0} + \int_A ((\Delta y)^2 + (\Delta z)^2) dA \quad (3.18)$$

The first term in equation (3.18) on the right hand side is the moment of inertia about axis  $x$  and the second term is zero. The second term is zero because it integral of center about center thus is zero. The third term is a new term and can be written as

$$\int_A ((\Delta y)^2 + (\Delta z)^2) dA = \overbrace{((\Delta y)^2 + (\Delta z)^2)}^{\text{constant}} \int_A dA = \overbrace{((\Delta y)^2 + (\Delta z)^2)}^{r^2} \overbrace{\int_A dA}^A = r^2 A \quad (3.19)$$

Hence, the relationship between the moment of inertia at  $xx$  and parallel axis  $x'x'$  is

Parallel Axis Equation

$I_{x'x'} = I_{xx} + r^2 A$

(3.20)

The moment of inertia of several areas is the sum of moment inertia of each area see Figure 3.5 and therefore,

$$I_{xx} = \sum_{i=1}^n I_{xxi} \quad (3.21)$$

If the same areas are similar thus

$$I_{xx} = \sum_{i=1}^n I_{xxi} = n I_{xxi} \quad (3.22)$$

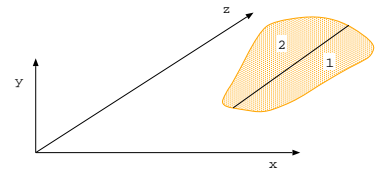

Fig. -3.5. The schematic to explain the summation of moment of inertia.



Equation (3.22) is very useful in the calculation of the moment of inertia utilizing the moment of inertia of known bodies. For example, the moment of inertia of half a circle is half of whole circle for axis a the center of circle. The moment of inertia can then move the center of area. of the

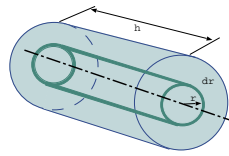

Fig. -3.6. Cylinder with an element for calculation moment of inertia.

### 3.3.3 Examples of Moment of Inertia

Example 3.2:

Calculate the moment of inertia for the mass of the cylinder about center axis which height of  $h$  and radius,  $r_0$ , as shown in Figure 3.6. The material is with a uniform density and homogeneous.

SOLUTION

The element can be calculated using cylindrical coordinate. Here the convenient element is a shell of thickness  $dr$  which shown in Figure 3.6 as

$$I_{rr} = \rho \int_V r^2 dm = \rho \int_0^{r_0} r^2 \overbrace{h 2\pi r dr}^{dV} = \rho h 2\pi \frac{r_0^4}{4} = \frac{1}{2} \rho h \pi r_0^4 = \frac{1}{2} m r_0^2$$

The radius of gyration is

$$r_k = \sqrt{\frac{\frac{1}{2} m r_0^2}{m}} = \frac{r_0}{\sqrt{2}}$$

End Solution

Example 3.3:

Calculate the moment of inertia of the rectangular shape shown in Figure 3.7 around  $x$  coordinate.

SOLUTION

The moment of inertia is calculated utilizing equation (3.14) as following

$$I_{xx} = \int_A \left( \overbrace{y^2}^0 + z^2 \right) dA = \int_0^a z^2 \overbrace{bdz}^{dA} = \frac{a^3 b}{3}$$

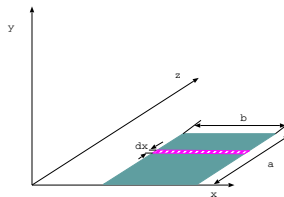

Fig. -3.7. Description of rectangular in  $x$ - $y$  plane for calculation of moment of inertia.

This value will be used in later examples.

End Solution

## Example 3.4:

To study the assumption of zero thickness, consider a simple shape to see the effects of this assumption. Calculate the moment of inertia about the center of mass of a square shape with a thickness,  $t$  compare the results to a square shape with zero thickness.

SOLUTION

The moment of inertia of transverse slice about  $y'$  (see Figure mech:fig:squareEll) is

$$dI_{xxm} = \rho \overbrace{dy}^t \frac{\overbrace{ba^3}^{I_{xx}}}{12} \quad (3.23)$$

The transformation into from local axis  $x$  to center axis,  $x'$  can be done as following

$$dI_{x'x'm} = \rho dy \left( \frac{\overbrace{ba^3}^{I_{xx}}}{12} + \underbrace{\frac{z^2}{r^2}}_{r^2} \underbrace{ba}_{A} \right) \quad (3.24)$$

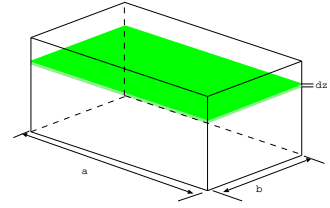

Fig. -3.8. A square element for the calculations of inertia of two-dimensional to three-dimensional deviations.

The total moment of inertia can be obtained by integration of equation (3.24) to write as

$$I_{xxm} = \rho \int_{-t/2}^{t/2} \left( \frac{ba^3}{12} + z^2 ba \right) dz = \rho t \frac{ab t^2 + a^3 b}{12} \quad (3.25)$$

Comparison with the thin body results in

$$\frac{I_{xx} \rho t}{I_{xxm}} = \frac{ba^3}{t^2 ba + ba^3} = \frac{1}{1 + \frac{t^2}{a^2}} \quad (3.26)$$

It can be noticed right away that equation (3.26) indicates that ratio approaches one when thickness ratio is approaches zero,  $I_{xxm}(t \rightarrow 0) \rightarrow 1$ . Additionally it can be noticed that the ratio  $a^2/t^2$  is the only contributor to the error<sup>2</sup>. The results are present in Figure 3.9. I can be noticed that the error is significant very fast even for small values of  $t/a$  while the with of the box,  $b$  has no effect on the error.

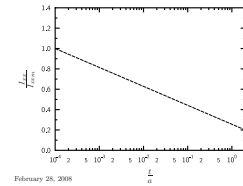

Fig. -3.9. The ratio of the moment of inertia of two-dimensional to three-dimensional.

End Solution

<sup>2</sup>This ratio is a dimensionless number that commonly has no special name. This author suggests to call this ratio as the B number.

Example 3.5:

Calculate the rectangular moment of Inertia for the rotation trough center in  $zz$  axis (axis of rotation is out of the page). Hint, construct a small element and build longer build out of the small one. Using this method calculate the entire rectangular.

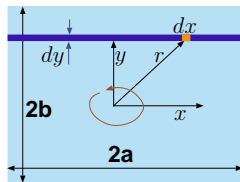

Fig. -3.10. Rectangular Moment of inertia.

SOLUTION

The moment of inertia for a long element with a distance  $y$  shown in Figure 3.10 is

$$dI_{zz}|_{dy} = \int_{-a}^a \overbrace{(y^2 + x^2)}^{r^2} dy dx = \frac{2(3ay^2 + a^3)}{3} dy \tag{3.V.a}$$

The second integration ( no need to use (3.20), why?) is

$$I_{zz} = \int_{-b}^b \frac{2(3ay^2 + a^3)}{3} dy \tag{3.V.b}$$

Results in

$$I_{zz} = \frac{a(2ab^3 + 2a^3b)}{3} = \overbrace{\frac{4ab}{A}}^A \left( \frac{(2a)^2 + (2b)^2}{12} \right) \tag{3.V.c}$$

Or

---

End Solution

Example 3.6:

Calculate the center of area and moment of inertia for the parabola,  $y = \alpha x^2$ , depicted in Figure 3.11. Hint, calculate the area first. Use this area to calculate moment of inertia. There are several ways to approach the calculation (different infinitesimal area).

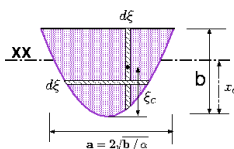

Fig. -3.11. Parabola for calculations of moment of inertia.

SOLUTION

For  $y = b$  the value of  $x = \sqrt{b/\alpha}$ . First the area inside the parabola calculated as

$$A = 2 \int_0^{\sqrt{b/\alpha}} \overbrace{(b - \alpha\xi^2)}^{dA/2} d\xi = \frac{2(3\alpha - 1)}{3} \left( \frac{b}{\alpha} \right)^{3/2}$$

The center of area can be calculated utilizing equation (3.6). The center of every element is at,  $\left(\alpha \xi^2 + \frac{b-\alpha \xi^2}{2}\right)$  the element area is used before and therefore

$$x_c = \frac{1}{A} \int_0^{\sqrt{b/\alpha}} \overbrace{\left(\alpha \xi^2 + \frac{b-\alpha \xi^2}{2}\right)}^{x_c} \overbrace{(b-\alpha \xi^2) d\xi}^{dA} = \frac{3\alpha b}{15\alpha - 5} \quad (3.27)$$

The moment of inertia of the area about the center can be found using in equation (3.27) can be done in two steps first calculate the moment of inertia in this coordinate system and then move the coordinate system to center. Utilizing equation (3.14) and doing the integration from 0 to maximum  $y$  provides

$$I_{x'x'} = 4 \int_0^b \xi^2 \sqrt{\frac{\xi}{\alpha}} d\xi = \frac{2b^{7/2}}{7\sqrt{\alpha}}$$

Utilizing equation (3.20)

$$I_{xx} = I_{x'x'} - A \Delta x^2 = \frac{4b^{7/2}}{7\sqrt{\alpha}} - \frac{3\alpha - 1}{3} \left(\frac{b}{\alpha}\right)^{3/2} \left(\frac{3\alpha b}{15\alpha - 5}\right)^2$$

or after working the details results in

$$I_{xx} = \frac{\sqrt{b} (20b^3 - 14b^2)}{35\sqrt{\alpha}}$$

---

End Solution

### Example 3.7:

Calculate the moment of inertia of straight angle triangle about its  $y$  axis as shown in the Figure on the right. Assume that base is  $a$  and the height is  $h$ . What is the moment when a symmetrical triangle is attached on left. What is the moment when a symmetrical triangle is attached on bottom. What is the moment inertia when  $a \rightarrow 0$ . What is the moment inertia when  $h \rightarrow 0$ .

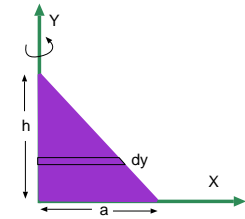

Fig. -3.12. Triangle for example 3.7.

### SOLUTION

The right edge line equation can be calculated as

$$\frac{y}{h} = \left(1 - \frac{x}{a}\right)$$

or

$$\frac{x}{a} = \left(1 - \frac{y}{h}\right)$$

Now using the moment of inertia of rectangle on the side ( $y$ ) coordinate (see example (3.3))

$$\int_0^h \frac{a \left(1 - \frac{y}{h}\right)^3 dy}{3} = \frac{a^3 h}{4}$$

For two triangles attached to each other the moment of inertia will be sum as  $\frac{a^3 h}{2}$   
The rest is under construction.

---

End Solution

---

### 3.3.4 Product of Inertia

In addition to the moment of inertia, the product of inertia is commonly used. Here only the product of the area is defined and discussed. The product of inertia defined as

$$I_{x_i x_j} = \int_A x_i x_j dA \quad (3.28)$$

For example, the product of inertia for  $x$  and  $y$  axes is

$$I_{xy} = \int_A x y dA \quad (3.29)$$

Product of inertia can be positive or negative value as oppose the moment of inertia. The calculation of the product of inertia isn't different much for the calculation of the moment of inertia. The units of the product of inertia are the same as for moment of inertia.

#### Transfer of Axis Theorem

Same as for moment of inertia there is also similar theorem.

$$I_{x' y'} = \int_A x' y' dA = \int_A (x + \Delta x)(y + \Delta y) dA \quad (3.30)$$

expanding equation (3.30) results in

$$I_{x' y'} = \underbrace{\int_A x y dA}_{I_{xy}} + \overbrace{\int_A x dA}^{\Delta y} \Delta y + \overbrace{\int_A y dA}^{\Delta x} \Delta x + \underbrace{\int_A \Delta x \Delta y dA}_{\Delta x \Delta y A} \quad (3.31)$$

The final form is

$$I_{x' y'} = I_{xy} + \Delta x \Delta y A \quad (3.32)$$

There are several relationships should be mentioned

$$I_{xy} = I_{yx} \quad (3.33)$$

Symmetrical area has zero product of inertia because integration of odd function (asymmetrical function) left part cancel the right part.

Example 3.8:

Calculate the product of inertia of straight edge triangle.

SOLUTION

The equation of the line is

$$y = \frac{a}{b}x + a$$

The product of inertia at the center is zero. The total product of inertia is

$$I_{x'y'} = 0 + \underbrace{\frac{\Delta x}{3}}_{\frac{a}{3}} \underbrace{\frac{\Delta y}{3}}_{\frac{b}{3}} \underbrace{\left(\frac{A}{2}\right)}_{\left(\frac{ab}{2}\right)} = \frac{a^2 b^2}{18}$$

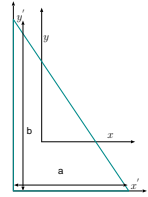

Fig. -3.13. Product of inertia for triangle.

End Solution

### 3.3.5 Principal Axes of Inertia

The inertia matrix or inertia tensor is

$$\begin{vmatrix} I_{xx} & -I_{xy} & -I_{xz} \\ -I_{yx} & I_{yy} & -I_{yz} \\ -I_{zx} & -I_{zy} & I_{zz} \end{vmatrix} \quad (3.34)$$

In linear algebra it was shown that for some angle equation (3.34) can be transform into

$$\begin{vmatrix} I_{x'x'} & 0 & 0 \\ 0 & I_{y'y'} & 0 \\ 0 & 0 & I_{z'z'} \end{vmatrix} \quad (3.35)$$

System which creates equation (3.35) referred as principle system.

## 3.4 Newton's Laws of Motion

These laws can be summarized in two statements one, for every action by body **A** on Body **B** there is opposite reaction by body **B** on body **A**. Two, which can expressed in mathematical form as

$$\sum \mathbf{F} = \frac{D(mU)}{Dt} \quad (3.36)$$

It can be noted that  $D$  replaces the traditional  $d$  since the additional meaning which be added. Yet, it can be treated as the regular derivative. This law apply to any body and any body can “broken” into many small bodies which connected to each other. These small “bodies” when became small enough equation (3.36) can be transformed to a continuous form as

$$\sum \mathbf{F} = \int_V \frac{D(\rho U)}{Dt} dV \quad (3.37)$$

The external forces are equal to internal forces the forces between the “small” bodies are cancel each other. Yet this examination provides a tool to study what happened in the fluid during operation of the forces.

Since the derivative with respect to time is independent of the volume, the derivative can be taken out of the integral and the alternative form can be written as

$$\sum \mathbf{F} = \frac{D}{Dt} \int_V \rho U dV \quad (3.38)$$

The velocity,  $U$  is a derivative of the location with respect to time, thus,

$$\sum \mathbf{F} = \frac{D^2}{Dt^2} \int_V \rho r dV \quad (3.39)$$

where  $r$  is the location of the particles from the origin.

The external forces are typically divided into two categories: body forces and surface forces. The body forces are forces that act from a distance like magnetic field or gravity. The surface forces are forces that act on the surface of the body (pressure, stresses). The same as in the dynamic class, the system acceleration called the internal forces. The acceleration is divided into three categories: Centrifugal,  $\boldsymbol{\omega} \times (\mathbf{r} \times \boldsymbol{\omega})$ , Angular,  $\mathbf{r} \times \dot{\boldsymbol{\omega}}$ , Coriolis,  $2(\mathbf{U}_r \times \boldsymbol{\omega})$ . The radial velocity is denoted as  $U_r$ .

### 3.5 Angular Momentum and Torque

The angular momentum of body,  $dm$ , is defined as

$$L = \mathbf{r} \times \mathbf{U} dm \quad (3.40)$$

The angular momentum of the entire system is calculated by integration (summation) of all the particles in the system as

$$L_s = \int_m \mathbf{r} \times \mathbf{U} dm \quad (3.41)$$

The change with time of angular momentum is called torque, in analogous to the momentum change of time which is the force.

$$T_r = \frac{DL}{Dt} = \frac{D}{Dt} (\mathbf{r} \times \mathbf{U} dm) \quad (3.42)$$

where  $T_\tau$  is the torque. The torque of entire system is

$$T_{\tau_s} = \int_m \frac{DL}{Dt} = \frac{D}{Dt} \int_m (\mathbf{r} \times \mathbf{U} dm) \quad (3.43)$$

It can be noticed (well, it can be proved utilizing vector mechanics) that

$$T_\tau = \frac{D}{Dt}(\mathbf{r} \times \mathbf{U}) = \frac{D}{Dt}(\mathbf{r} \times \frac{D\mathbf{r}}{Dt}) = \frac{D^2\mathbf{r}}{Dt^2} \quad (3.44)$$

To understand these equations a bit better, consider a particle moving in x-y plane. A force is acting on the particle in the same plane (x-y) plane. The velocity can be written as  $U = u\hat{i} + v\hat{j}$  and the location from the origin can be written as  $\mathbf{r} = x\hat{i} + y\hat{j}$ . The force can be written, in the same fashion, as  $\mathbf{F} = F_x\hat{i} + F_y\hat{j}$ . Utilizing equation (3.40) provides

$$\mathbf{L} = \mathbf{r} \times \mathbf{U} = \begin{pmatrix} \hat{i} & \hat{j} & \hat{k} \\ x & y & 0 \\ u & v & 0 \end{pmatrix} = (xv - yu)\hat{k} \quad (3.45)$$

Utilizing equation (3.42) to calculate the torque as

$$T_\tau = \mathbf{r} \times \mathbf{F} = \begin{pmatrix} \hat{i} & \hat{j} & \hat{k} \\ x & y & 0 \\ F_x & F_y & 0 \end{pmatrix} = (xF_x - yF_y)\hat{k} \quad (3.46)$$

Since the torque is a derivative with respect to the time of the angular momentum it is also can be written as

$$xF_x - yF_y = \frac{D}{Dt} [(xv - yu) dm] \quad (3.47)$$

The torque is a vector and the various components can be represented as

$$T_{\tau_x} = \hat{i} \bullet \frac{D}{Dt} \int_m \mathbf{r} \times \mathbf{U} dm \quad (3.48)$$

In the same way the component in  $y$  and  $z$  can be obtained.

### 3.5.1 Tables of geometries

The following tables present several moment of inertias of commonly used geometries.



Table -3.1. Moments of Inertia for various plane surfaces about their center of gravity (full shapes)

Shape Name	Picture description	$x_c, y_c$	A	$I_{xx}$
Rectangle		$\frac{b}{2}; \frac{a}{2}$	$ab$	$\frac{ab^3}{12}$
Triangle		$\frac{a}{3}$	$\frac{ab}{3}$	$\frac{ab^3}{36}$
Circle		$\frac{b}{2}$	$\frac{\pi b^2}{4}$	$\frac{\pi b^4}{64}$
Ellipse		$\frac{b}{2} \frac{b}{2}$	$\frac{\pi ab}{4}$	$\frac{Ab^2}{64}$
$y = \alpha x^2$ Parabola		$\frac{3 \alpha b}{15 \alpha - 5}$	$\frac{6\alpha - 2}{3} \times \left(\frac{b}{\alpha}\right)^{\frac{3}{2}}$	$\frac{\sqrt{b} (20 b^3 - 14 b^2)}{35 \sqrt{\alpha}}$

Table -3.2. Moment of inertia for various plane surfaces about their center of gravity

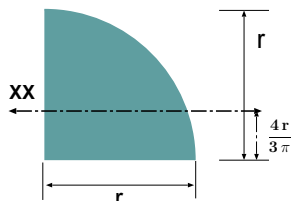
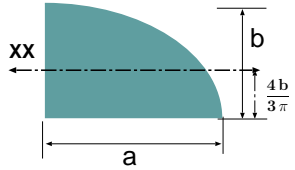
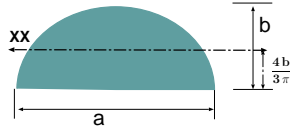
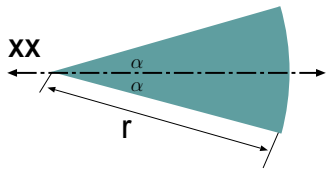
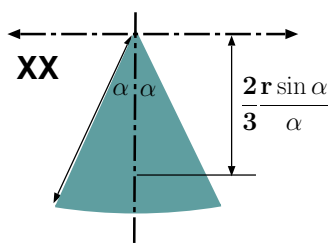
Shape Name	Picture description	$x_c, y_c$	A	$I_{xx}$
Quadrant of Circle		$\frac{4r}{3\pi}$	$\frac{\pi r^2}{4}$	$r^4 \left( \frac{\pi}{16} - \frac{4}{9\pi} \right)$
Ellipsoidal Quadrant		$\frac{4b}{3\pi}$	$\frac{\pi ab}{4}$	$ab^3 \left( \frac{\pi}{16} - \frac{4}{9\pi} \right)$
Half of Elliptic		$\frac{4b}{3\pi}$	$\frac{\pi ab}{4}$	$ab^3 \left( \frac{\pi}{16} - \frac{4}{9\pi} \right)$
Circular Sector		0	$2\alpha r^2$	$\frac{r^4}{4} \left( \alpha - \frac{1}{2} \sin 2\alpha \right)$
Circular Sector		$\frac{2}{3} \frac{r \sin \alpha}{\alpha}$	$2\alpha r^2$	$I_{x'x'} = \frac{r^4}{4} \left( \alpha + \frac{1}{2} \sin 2\alpha \right)$

---

# CHAPTER 4

---

## Fluids Statics

### 4.1 Introduction

The simplest situation that can occur in the study of fluid is when the fluid is at rest or quasi rest. This topic was introduced to most students in previous study of rigid body. However, here this topic will be more vigorously examined. Furthermore, the student will be exposed to stability analysis probably for the first time. Later, the methods discussed here will be expanded to more complicated dynamics situations.

### 4.2 The Hydrostatic Equation

A fluid element with dimensions of  $dx$ ,  $dy$ , and  $dz$  is motionless in the accelerated system, with acceleration,  $a$  as shown in Figure 4.1. The system is in a body force field,  $g_G(x, y, z)$ . The combination of an acceleration and the body force results in effective body force which is

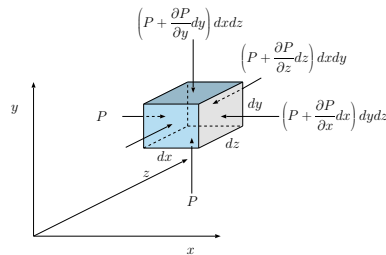

Fig. -4.1. Description of a fluid element in accelerated system under body forces.

$$\mathbf{g}_G - a = g_{\text{eff}} \quad (4.1)$$

Equation (4.1) can be reduced and simplified for the case of zero acceleration,  $\mathbf{a} = 0$ .

In these derivations, several assumptions must be made. The first assumption is that the change in the pressure is a continuous function. There is no requirement that the pressure has to be a monotonous function e.g. that pressure can increase and later decrease. The changes of the second derivative pressure are not significant compared to the first derivative ( $\partial P / \partial n \times dl \gg \partial^2 P / \partial n^2$ ). where  $n$  is the steepest

direction of the pressure derivative and  $d\ell$  is the infinitesimal length. This mathematical statement simply requires that the pressure can deviate in such a way that the average on infinitesimal area can be found and expressed as only one direction. The net pressure force on the faces in the  $x$  direction results in

$$d\mathbf{F} = - \left( \frac{\partial P}{\partial x} \right) dydx \hat{i} \quad (4.2)$$

In the same fashion, the calculations of the three directions result in the total net pressure force as

$$\sum_{\text{surface}} \mathbf{F} = - \left( \frac{\partial P}{\partial x} \hat{i} + \frac{\partial P}{\partial y} \hat{j} + \frac{\partial P}{\partial z} \hat{k} \right) \quad (4.3)$$

The term in the parentheses in equation (4.3) referred to in the literature as the pressure gradient (see for more explanation in the Mathematics Appendix). This mathematical operation has a geometrical interpretation. If the pressure,  $P$ , was a two-dimensional height (that is only a function of  $x$  and  $y$ ) then the gradient is the steepest ascent of the height (to the valley). The second point is that the gradient is a vector (that is, it has a direction). Even though, the pressure is treated, now, as a scalar function (there no reference to the shear stress in part of the pressure) the gradient is a vector. For example, the dot product of the following is

$$\hat{i} \cdot \mathbf{grad}P = \hat{i} \cdot \nabla P = \frac{\partial P}{\partial x} \quad (4.4)$$

In general, if the coordinates were to “rotate/transform” to a new system which has a different orientation, the dot product results in

$$\hat{i}_n \cdot \mathbf{grad}P = \hat{i}_n \cdot \nabla P = \frac{\partial P}{\partial n} \quad (4.5)$$

where  $\hat{i}_n$  is the unit vector in the  $n$  direction and  $\partial/\partial n$  is a derivative in that direction.

As before, the effective gravity force is utilized in case where the gravity is the only body force and in an accelerated system. The body (element) is in rest and therefore the net force is zero

$$\sum_{\text{total}} \mathbf{F} = \sum_{\text{surface}} \mathbf{F} + \sum_{\text{body}} \mathbf{F} \quad (4.6)$$

Hence, the utilizing the above derivations one can obtain

$$-\mathbf{grad}P dx dy dz + \rho g_{\text{eff}} dx dy dz = 0 \quad (4.7)$$

or

Pressure Gradient

$$\mathbf{grad}P = \nabla P = \rho g_{\text{eff}} \quad (4.8)$$

Some refer to equation (4.8) as the Fluid Static Equation. This equation can be integrated and therefore solved. However, there are several physical implications to this equation which should be discussed and are presented here. First, a discussion on a simple condition and will continue in more challenging situations.

### 4.3 Pressure and Density in a Gravitational Field

In this section, a discussion on the pressure and the density in various conditions is presented.

#### 4.3.1 Constant Density in Gravitational Field

The simplest case is when the density,  $\rho$ , pressure,  $P$ , and temperature,  $T$  (in a way no function of the location) are constant. Traditionally, the  $z$  coordinate is used as the (negative) direction of the gravity<sup>1</sup>. The effective body force is

$$g_{\text{eff}} = -g \hat{k} \quad (4.9)$$

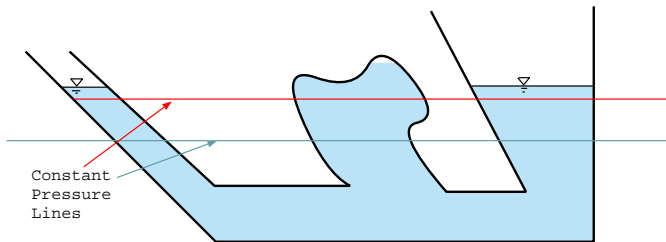

Fig. -4.2. Pressure lines in a static fluid with a constant density.

Utilizing equation (4.9) and substituting it into equation (4.8) results into three simple partial differential equations. These equations are

$$\frac{\partial P}{\partial x} = \frac{\partial P}{\partial y} = 0 \quad (4.10)$$

and

$$\frac{\partial P}{\partial z} = -\rho g \quad (4.11)$$

<sup>1</sup>This situation were the tradition is appropriated, it will be used. There are fields where  $x$  or  $y$  are designed to the direction of the gravity and opposite direction. For this reason sometime there will be a deviation from the above statement.

Equations (4.10) can be integrated to yield

$$P(x, y) = \text{constant} \quad (4.12)$$

and constant in equation (4.12) can be absorbed by the integration of equation (4.11) and therefore

$$P(x, y, z) = -\rho g z + \text{constant} \quad (4.13)$$

The integration constant is determined from the initial conditions or another point. For example, if at point  $z_0$  the pressure is  $P_0$  then the equation (4.13) becomes

$$P(z) - P_0 = -\rho g (z - z_0) \quad (4.14)$$

It is evident from equation (4.13) that the pressure depends only on  $z$  and/or the constant pressure lines are in the plane of  $x$  and  $y$ . Figure 4.2 describes the constant pressure lines in the container under the gravity body force. The pressure lines are continuous even in area where there is a discontinuous fluid. The reason that a solid boundary doesn't break the continuity of the pressure lines is because there is always a path to some of the planes.

It is convenient to reverse the direction of  $z$  to get rid of the negative sign and to define  $h$  as the dependent of the fluid that is  $h \equiv -(z - z_0)$  so equation (4.14) becomes

Pressure relationship

$$P(h) - P_0 = \rho g h \quad (4.15)$$

In the literature, the right hand side of the equation (4.15) is defined as piezometric pressure.

**Example 4.1:**

*Two chambers tank depicted in Figure 4.4 are in equilibration. If the air mass at chamber A is 1 Kg while the mass at chamber B is unknown. The difference in the*

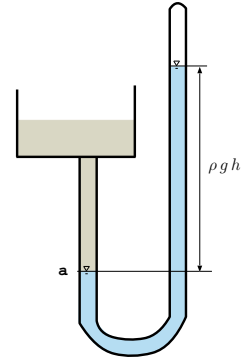

Fig. -4.3. A schematic to explain the measure of the atmospheric pressure.

liquid heights between the two chambers is 2[m]. The liquid in the two chambers is water. The area of each chamber is 1[m<sup>2</sup>]. Calculate the air mass in chamber B. You can assume ideal gas for the air and the water is incompressible substance with density of 1000[kg/m<sup>3</sup>]. The total height of the tank is 4[m]. Assume that the chambers are at the same temperature of 27°C.

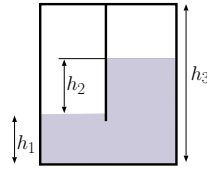

Fig. -4.4. The effective gravity is for accelerated cart.

#### SOLUTION

The equation of state for the chamber A is

$$m_A = \frac{RT}{P_A V_A} \quad (4.1.a)$$

The equation of state for the second chamber is

$$m_B = \frac{RT}{P_B V_B} \quad (4.1.b)$$

The water volume is

$$V_{total} = h_1 A + (h_1 + h_2)A = (2h_1 + h_2) A \quad (4.1.c)$$

The pressure difference between the liquid interface is estimated negligible the air density as

$$P_A - P_B = \Delta P = h_2 \rho g \quad (4.1.d)$$

combining equations (4.1.a), (4.1.b) results in

$$\frac{RT}{m_A V_A} - \frac{RT}{m_B V_B} = h_2 \rho g \implies \left( 1 - \frac{1}{\frac{m_B V_B}{m_A V_A}} \right) = \frac{h_2 \rho g m_A V_A}{RT} \quad (4.1.e)$$

In equation the only unknown is the ratio of  $m_B/m_A$  since everything else is known. Denoting  $X = m_B/m_A$  results in

$$\frac{1}{X} = 1 - \frac{h_2 \rho g m_A V_A}{RT} \implies X = \frac{1}{1 - \frac{h_2 \rho g m_A V_A}{RT}} \quad (4.1.f)$$

End Solution

The following question is a very nice qualitative question of understanding this concept.

Example 4.2:

A tank with opening at the top to the atmosphere contains two immiscible liquids one heavy and one light as depicted in Figure 4.5 (the light liquid is on the top of the heavy liquid). Which piezometric tube will be higher? why? and how much higher? What is the pressure at the bottom of the tank?

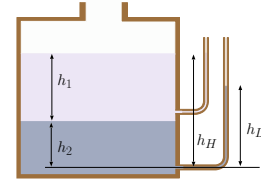

Fig. -4.5. Tank and the effects different liquids.

SOLUTION

The common instinct is to find that the lower tube will contain the higher liquids. For the case, the lighter liquid is on the top the heavier liquid the the top tube is the same as the surface. However, the lower tube will raise only to (notice that  $g$  is canceled)

$$h_L = \frac{\rho_1 h_1 + \rho_2 h_2}{\rho_2} \quad (4.11.a)$$

Since  $\rho_1 > \rho_2$  the mathematics dictate that the height of the second is lower. The difference is

$$\frac{h_H - h_L}{h_2} = \frac{h_H}{h_2} - \left( \frac{\rho_1 h_1 + \rho_2 h_2}{h_2 \rho_2} \right) \quad (4.11.b)$$

It can be noticed that  $h_H = h_1 + h_2$  hence,

$$\frac{h_H - h_L}{h_2} = \frac{h_1 + h_2}{h_2} - \left( \frac{\rho_1 h_1 + \rho_2 h_2}{h_2 \rho_2} \right) = \frac{h_1}{h_2} \left( 1 - \frac{\rho_1}{\rho_2} \right) \quad (4.11.c)$$

or

$$h_H - h_L = h_1 \left( 1 - \frac{\rho_1}{\rho_2} \right) \quad (4.11.d)$$

The only way the  $h_L$  to be higher of  $h_H$  is if the heavy liquid is on the top if the stability allow it. The pressure at the bottom is

$$P = P_{atmos} + g (\rho_1 h_1 + \rho_2 h_2) \quad (4.16)$$

End Solution

**Example 4.3:**

The effect of the water in the car tank is more than the possibility that water freeze in fuel lines. The water also can change measurement of fuel gage. The way the interpretation of an automobile fuel gage is proportional to the pressure at the bottom of the fuel tank. Part of the tank height is filled with the water at the bottom (due to the larger density). Calculate the error for a give ratio between the fuel density to the water.

SOLUTION



The ratio of the fuel density to water density is  $\zeta = \rho_f/\rho_w$  and the ratio of the total height to the water height is  $x = h_w/h_{total}$ . Thus the pressure at the bottom when the tank is full with only fuel

$$P_{full} = \rho_f h_{total} g \quad (4.III.a)$$

But when water is present the pressure will be the same at

$$P_{full} = (\rho_w x + \phi \rho_f) g h_{total} \quad (4.III.b)$$

and if the two are equal at

$$\rho_f h_{total} g = (\rho_w x + \phi \rho_f) g h_{total} \quad (4.III.c)$$

where  $\phi$  in this case the ratio of the full height (on the fake) to the total height. Hence,

$$\phi = \frac{\rho_f - x \rho_w}{\rho_f} \quad (4.III.d)$$

---

End Solution

---

## 4.3.2 Pressure Measurement

### 4.3.2.1 Measuring the Atmospheric Pressure

One of the application of this concept is the idea of measuring the atmospheric pressure. Consider a situation described in Figure 4.3. The liquid is filling the tube and is brought into a steady state. The pressure above the liquid on the right side is the vapor pressure. Using liquid with a very low vapor pressure like mercury, will result in a device that can measure the pressure without additional information (the temperature).

Example 4.4:

*Calculate the atmospheric pressure at 20°C. The high of the Mercury is 0.76 [m] and the gravity acceleration is 9.82[m/sec]. Assume that the mercury vapor pressure is 0.000179264[kPa]. The description of the height is given in Figure 4.3. The mercury density is 13545.85[kg/m³].*

#### SOLUTION

The pressure is uniform or constant plane perpendicular to the gravity. Hence, knowing any point on this plane provides the pressure anywhere on the plane. The atmospheric pressure at point **a** is the same as the pressure on the right hand side of the tube. Equation (4.15) can be utilized and it can be noticed that pressure at point **a** is

$$P_a = \rho g h + P_{vapor} \quad (4.17)$$

The density of the mercury is given along with the gravity and therefore,

$$P_a = 13545.85 \times 9.82 \times 0.76 \sim 101095.39[Pa] \sim 1.01[Bar]$$

The vapor pressure is about  $1 \times 10^{-4}$  percent of the total results.

---

End Solution

---

The main reason the mercury is used because of its large density and the fact that it is in a liquid phase in most of the measurement range. The third reason is the low vapor (partial) pressure of the mercury. The partial pressure of mercury is in the range of the 0.000001793[Bar] which is insignificant compared to the total measurement as can be observed from the above example.

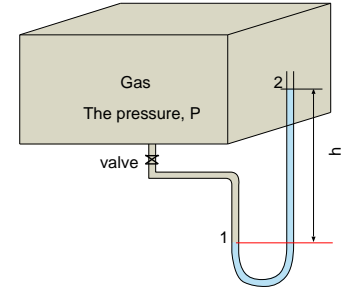

Fig. -4.6. Schematic of gas measurement utilizing the "U" tube.

Example 4.5:

A liquid<sup>2</sup> **a** in amount  $H_a$  and a liquid **b** in amount  $H_b$  in to an U tube. The ratio of the liquid densities is  $\alpha = \rho_1/\rho_2$ . The width of the U tube is  $L$ . Locate the liquids surfaces.

#### SOLUTION

The question is to find the equilibrium point where two liquids balance each other. If the width of the U tube is equal or larger than total length of the two liquids then the whole liquid will be in bottom part. For smaller width,  $L$ , the ratio between two sides will be as

$$\rho_1 h_1 = \rho_2 h_2 \rightarrow h_2 = \alpha h_1$$

The mass conservation results in

$$H_a + H_b = L + h_1 + h_2$$

Thus two equations and two unknowns provide the solution which is

$$h_1 = \frac{H_a + H_b - L}{1 + \alpha}$$

When  $H_a > L$  and  $\rho_a (H_a - L) \geq \rho_b$  (or the opposite) the liquid **a** will be on the two sides of the U tube. Thus, the balance is

$$h_1 \rho_b + h_2 \rho_a = h_3 \rho_a$$

where  $h_1$  is the height of liquid **b** where  $h_2$  is the height of "extra" liquid **a** and same side as liquid **b** and where  $h_3$  is the height of liquid **b** on the other side. When in this case  $h_1$  is equal to  $H_b$ . The additional equation is the mass conservation as

$$H_a = h_2 + L + h_3$$

The solution is

$$h_2 = \frac{(H_a - L) \rho_a - H_b \rho_b}{2 \rho_a}$$

End Solution

<sup>2</sup>This example was requested by several students who found their instructor solution unsatisfactory.

### 4.3.2.2 Pressure Measurement

The idea describes the atmospheric measurement that can be extended to measure the pressure of the gas chambers. Consider a chamber filled with gas needed to be measured (see Figure 4.6). One technique is to attached “U” tube to the chamber and measure the pressure. This way, the gas is prevented from escaping and its pressure can be measured with a minimal interference to the gas (some gas enters to the tube).

The gas density is significantly lower than the liquid density and therefore can be neglected. The pressure at point “1” is

$$P_1 = P_{atmos} + \rho g h \quad (4.18)$$

Since the atmospheric pressure was measured previously (the technique was shown in the previous section) the pressure of the chamber can be measured.

### 4.3.2.3 Magnified Pressure Measurement

For situations where the pressure difference is very small, engineers invented more sensitive measuring device. This device is build around the fact that the height is a function of the densities difference. In the previous technique, the density of one side was neglected (the gas side) compared to other side (liquid). This technique utilizes the opposite range. The densities of the two sides are very close to each other, thus the height become large. Figure 4.7 shows a typical and simple schematic of such an instrument. If the pressure differences between  $P_1$  and  $P_2$  is small this instrument can “magnified” height,  $h_1$  and provide “better” accuracy reading. This device is based on the following mathematical explanation.

In steady state, the pressure balance (only differences) is

$$P_1 + g \rho_1 (h_1 + h_2) = P_2 + g h_2 \rho_2 \quad (4.19)$$

It can be noticed that the “missing height” is canceled between the two sides. It can be noticed that  $h_1$  can be positive or negative or zero and it depends on the ratio that two containers filled with the light density liquid. Additionally, it can be observed that  $h_1$  is relatively small because  $A_1 \gg A_2$ . The densities of the liquid are chosen so that they are close to each other but not equal. The densities of the liquids are chosen to be much heavier than the measured gas density. Thus, in writing equation (4.19) the gas density was neglected. The pressure difference can be expressed as

$$P_1 - P_2 = g [\rho_2 h_2 - \rho_1 (h_1 + h_2)] \quad (4.20)$$

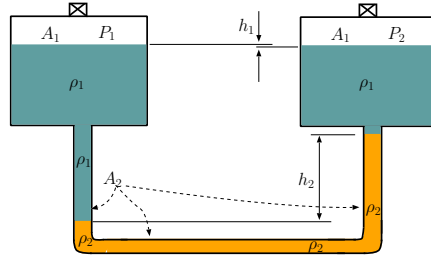

Fig. -4.7. Schematic of sensitive measurement device.

If the light liquid volume in the two containers is known, it provides the relationship between  $h_1$  and  $h_2$ . For example, if the volumes in two containers are equal then

$$-h_1 A_1 = h_2 A_2 \longrightarrow h_1 = -\frac{h_2 A_2}{A_1} \quad (4.21)$$

Liquid volumes do not necessarily have to be equal. Additional parameter, the volume ratio, will be introduced when the volumes ratio isn't equal. The calculations as results of this additional parameter does not cause a significant complications. Here, this ratio equals to one and it simplify the equation (4.21). But this ratio can be inserted easily into the derivations. With the equation for height (4.21) equation (4.19) becomes

$$P_1 - P_2 = g h_2 \left( \rho_2 - \rho_1 \left( 1 - \frac{A_2}{A_1} \right) \right) \quad (4.22)$$

or the height is

$$h_2 = \frac{P_1 - P_2}{g \left[ (\rho_2 - \rho_1) + \rho_1 \frac{A_2}{A_1} \right]} \quad (4.23)$$

For the small value of the area ratio,  $A_2/A_1 \ll 1$ , then equation (4.23) becomes

$$h_2 = \frac{P_1 - P_2}{g (\rho_2 - \rho_1)} \quad (4.24)$$

Some refer to the density difference shown in equation (4.24) as “magnification factor” since it replace the regular density,  $\rho_2$ .

### Inclined Manometer

One of the old methods of pressure measurement is the inclined manometer. In this method, the tube leg is inclined relatively to gravity (depicted in Figure 4.8). This method is an attempt to increase the accuracy by “extending” length visible of the tube. The equation (4.18) is then

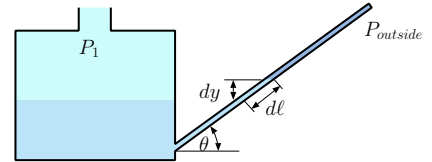

Fig. -4.8. Inclined manometer.

$$P_1 - P_{outside} = \rho g d\ell \quad (4.25)$$

If there is a insignificant change in volume (the area ratio between tube and inclined leg is significant), a location can be calibrated on the inclined leg as zero<sup>3</sup>.

### Inverted U-tube manometer

<sup>3</sup>This author's personal experience while working in a ship that use this manometer which is significantly inaccurate (first thing to be replaced on the ship). Due to surface tension, caused air entrapment especially in rapid change of the pressure or height.

The difference in the pressure of two different liquids is measured by this manometer. This idea is similar to “magnified” manometer but in reversed. The pressure line are the same for both legs on line  $ZZ$ . Thus, it can be written as the pressure on left is equal to pressure on the right legs (see Figure 4.9).

$$\overbrace{P_2 - \rho_2 (b + h)}^{\text{right leg}} g = \overbrace{P_1 - \rho_1 a - \rho h}^{\text{left leg}} g \quad (4.26)$$

Rearranging equation (4.26) leads to

$$P_2 - P_1 = \rho_2 (b + h) g - \rho_1 a g - \rho h g \quad (4.27)$$

For the similar density of  $\rho_1 = \rho_2$  and for  $a = b$  equation (4.27) becomes

$$P_2 - P_1 = (\rho_1 - \rho) g h \quad (4.28)$$

As in the previous “magnified” manometer if the density difference is very small the height become very sensitive to the change of pressure.

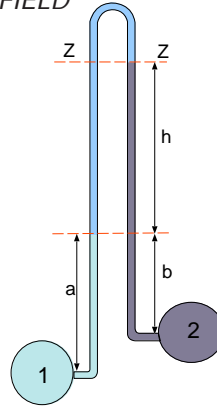

Fig. -4.9. Schematic of inverted manometer.

### 4.3.3 Varying Density in a Gravity Field

There are several cases that will be discussed here which are categorized as gases, liquids and other. In the gas phase, the equation of state is simply the ideal gas model or the ideal gas with the compressibility factor (sometime referred to as real gas). The equation of state for liquid can be approximated or replaced by utilizing the bulk modulus. These relationships will be used to find the functionality between pressure, density and location.

#### 4.3.3.1 Gas Phase under Hydrostatic Pressure

##### Ideal Gas under Hydrostatic Pressure

The gas density vary gradually with the pressure. As first approximation, the ideal gas model can be employed to describe the density. Thus equation (4.11) becomes

$$\frac{\partial P}{\partial z} = -\frac{g P}{RT} \quad (4.29)$$

Separating the variables and changing the partial derivatives to full derivative (just a notation for this case) results in

$$\frac{dP}{P} = -\frac{g dz}{RT} \quad (4.30)$$

Equation (4.30) can be integrated from point "0" to any point to yield

$$\ln \frac{P}{P_0} = -\frac{g}{RT} (z - z_0) \quad (4.31)$$

It is convenient to rearrange equation (4.31) to the following

$$\frac{P}{P_0} = e^{-\left(\frac{g(z-z_0)}{RT}\right)} \quad (4.32)$$

Here the pressure ratio is related to the height exponentially. Equation (4.32) can be expanded to show the difference to standard assumption of constant pressure as

$$\frac{P}{P_0} = 1 - \overbrace{\frac{h \rho_0 g}{P_0}}^{\text{correction factor}} + \frac{(z - z_0)^2 g}{6 RT} + \dots \quad (4.33)$$

Or in a simplified form where the transformation of  $h = (z - z_0)$  to be

$$\frac{P}{P_0} = 1 + \frac{\rho_0 g}{P_0} \left( h - \overbrace{\frac{h^2}{6}}^{\text{correction factor}} + \dots \right) \quad (4.34)$$

Equation (4.34) is useful in mathematical derivations but should be ignored for practical use<sup>4</sup>.

### Real Gas under Hydrostatic Pressure

The mathematical derivations for ideal gas can be reused as a foundation for the real gas model ( $P = Z\rho RT$ ). For a large range of  $P/P_c$  and  $T/T_c$ , the value of the compressibility factor,  $Z$ , can be assumed constant and therefore can be swallowed into equations (4.32) and (4.33). The compressibility is defined in equation (2.39). The modified equation is

$$\frac{P}{P_0} = e^{-\left(\frac{g(z-z_0)}{Z RT}\right)} \quad (4.35)$$

Or in a series form which is

$$\frac{P}{P_0} = 1 - \frac{(z - z_0) g}{Z RT} + \frac{(z - z_0)^2 g}{6 Z RT} + \dots \quad (4.36)$$

Without going through the mathematics, the first approximation should be noticed that the compressibility factor,  $Z$  enter the equation as  $h/Z$  and not just  $h$ . Another point that is worth discussing is the relationship of  $Z$  to other gas properties. In general, the relationship is very complicated and in some ranges  $Z$  cannot be assumed constant. In these cases, a numerical integration must be carried out.

<sup>4</sup>These derivations are left for a mathematical mind person. These deviations have a limited practical purpose. However, they are presented here for students who need to answer questions on this issue.

### 4.3.3.2 Liquid Phase Under Hydrostatic Pressure

The bulk modulus was defined in equation (1.28). The simplest approach is to assume that the bulk modulus is constant (or has some representative average). For these cases, there are two differential equations that needed to be solved. Fortunately, here, only one hydrostatic equation depends on density equation. So, the differential equation for density should be solved first. The governing differential density equation (see equation (1.28)) is

$$\rho = B_T \frac{\partial \rho}{\partial P} \quad (4.37)$$

The variables for equation (4.37) should be separated and then the integration can be carried out as

$$\int_{P_0}^P dP = \int_{\rho_0}^{\rho} B_T \frac{d\rho}{\rho} \quad (4.38)$$

The integration of equation (4.38) yields

$$P - P_0 = B_T \ln \frac{\rho}{\rho_0} \quad (4.39)$$

Equation (4.39) can be represented in a more convenient form as

Density variation

$$\rho = \rho_0 e^{\frac{P-P_0}{B_T}} \quad (4.40)$$

Equation (4.40) is the counterpart for the equation of state of ideal gas for the liquid phase. Utilizing equation (4.40) in equation (4.11) transformed into

$$\frac{\partial P}{\partial z} = -g\rho_0 e^{\frac{P-P_0}{B_T}} \quad (4.41)$$

Equation (4.41) can be integrated to yield

$$\frac{B_T}{g\rho_0} e^{\frac{P-P_0}{B_T}} = z + Constant \quad (4.42)$$

It can be noted that  $B_T$  has units of pressure and therefore the ratio in front of the exponent in equation (4.42) has units of length. The integration constant, with units of length, can be evaluated at any specific point. If at  $z = 0$  the pressure is  $P_0$  and the density is  $\rho_0$  then the constant is

$$Constant = \frac{B_T}{g\rho_0} \quad (4.43)$$

This constant,  $B_T/g\rho_0$ , is a typical length of the problem. Additional discussion will be presented in the dimensionless issues chapter (currently under construction). The solution becomes

$$\frac{B_T}{g\rho_0} \left( e^{\frac{P-P_0}{B_T}} - 1 \right) = z \quad (4.44)$$

Or in a dimensionless form

Density in Liquids

$$\left( e^{\frac{P-P_0}{B_T}} - 1 \right) = \frac{z g \rho_0}{B_T} \quad (4.45)$$

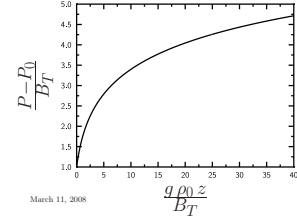

Fig. -4.10. Hydrostatic pressure when there is compressibility in the liquid phase.

The solution is presented in equation (4.44) and is plotted in Figure 4.10. The solution is a reverse function (that is not  $P = f(z)$  but  $z = f(P)$ ) it is a monotonous function which is easy to solve for any numerical value (that is only one  $z$  corresponds to any Pressure). Sometimes, the solution is presented as

$$\frac{P}{P_0} = \frac{B_T}{P_0} \ln \left( \frac{g\rho_0 z}{B_T} + 1 \right) + 1 \quad (4.46)$$

An approximation of equation (4.45) is presented for historical reasons and in order to compare the constant density assumption. The exponent can be expanded as

$$\left( \underbrace{\left( \frac{P-P_0}{B_T} \right)}_{\text{piezometric pressure}} + \overbrace{\left( \frac{B_T}{2} \left( \frac{P-P_0}{B_T} \right)^2 + \frac{B_T}{6} \left( \frac{P-P_0}{B_T} \right)^3 + \dots \right)}^{\text{corrections}} \right) = z g \rho_0 \quad (4.47)$$

It can be noticed that equation (4.47) is reduced to the standard equation when the normalized pressure ratio,  $P/B_T$  is small ( $\ll 1$ ). Additionally, it can be observed that the correction is on the left hand side and not as the “traditional” correction on the piezometric pressure side.

After the above approach was developed, new approached was developed to answer questions raised by hydraulic engineers. In the new approach is summarized by the following example.

#### Example 4.6:

*The hydrostatic pressure was neglected in example 1.12. In some places the ocean depth is many kilometers (the deepest places is more than 10 kilometers). For this example, calculate the density change in the bottom of 10 kilometers using two methods. In one method assume that the density is remain constant until the bottom. In the second method assume that the density is a function of the pressure.*

#### SOLUTION



For the the first method the density is

$$B_T \cong \frac{\Delta P}{\Delta V/V} \implies \Delta V = V \frac{\Delta P}{B_T} \quad (4.VI.a)$$

The density at the surface is  $\rho = m/V$  and the density at point  $x$  from the surface the density is

$$\rho(x) = \frac{m}{V - \Delta V} \implies \rho(x) = \frac{m}{V - V \frac{\Delta P}{B_T}} \quad (4.VI.b)$$

In this Chapter it was shown (integration of equation (4.8)) that the change pressure for constant gravity is

$$\Delta P = g \int_0^z \rho(z) dz \quad (4.VI.c)$$

Combining equation (4.VI.b) with equation (4.VI.c) yields

$$\rho(z) = \frac{m}{V - \frac{Vg}{B_T} \int_0^z \rho(z) dz} \quad (4.VI.d)$$

Equation can be rearranged to be

$$\rho(z) = \frac{m}{V \left( 1 - \frac{g}{B_T} \int_0^z \rho(z) dz \right)} \implies \rho(z) = \frac{\rho_0}{\left( 1 - \frac{g}{B_T} \int_0^z \rho(z) dz \right)} \quad (4.VI.e)$$

Equation (4.VI.e) is an integral equation which is discussed in the appendix<sup>5</sup>. It is convenient to rearrange further equation (4.VI.e) to

$$1 - \frac{g}{B_T} \int_0^z \rho(z) dz = \frac{\rho_0}{\rho(z)} \quad (4.VI.f)$$

The integral equation (4.VI.f) can be converted to a differential equation form when the two sides are differentiated as

$$\frac{g}{B_T} \rho(z) + \frac{\rho_0}{\rho(z)^2} \frac{d\rho(z)}{dz} = 0 \quad (4.VI.g)$$

equation (4.VI.g) is first order non-linear differential equation which can be transformed into

$$\frac{g \rho(z)^3}{B_T \rho_0} + \frac{d\rho(z)}{dz} = 0 \quad (4.VI.h)$$

The solution of equation (4.VI.h) is

$$\frac{\rho_0 B_T}{2g \rho^2} = z + c \quad (4.VI.i)$$

---

<sup>5</sup>Under construction

or rearranged as

$$\rho = \sqrt{\frac{\rho_0 B_T}{2g(z+c)}} \quad (4.VI.j)$$

The integration constant can be found by the fact that at  $z = 0$  the density is  $\rho_0$  and hence

$$\rho_0 = \sqrt{\frac{\rho_0 B_T}{2g(c)}} \implies c = \frac{B_T}{2g\rho_0} \quad (4.VI.k)$$

Substituting the integration constant and opening the parentheses, the solution is

$$\rho = \sqrt{\frac{\rho_0 B_T}{2gz + \frac{2gB_T}{2g\rho_0}}} \quad (4.48)$$

Or

$$\rho = \sqrt{\frac{\frac{1}{\rho_0} \rho_0^2 B_T}{\frac{1}{\rho_0} (2g\rho_0 z + B_T)}} \implies \frac{\rho}{\rho_0} = \sqrt{\frac{B_T}{(2g\rho_0 z + B_T)}} \quad (4.VI.l)$$

Equation (4.VI.l) further be rearranged to a final form as

$$\frac{\rho}{\rho_0} = \sqrt{\frac{\cancel{B_T}^1}{\cancel{B_T} \left( \frac{2g\rho_0 z}{B_T} + 1 \right)}} \implies \frac{\rho}{\rho_0} = \sqrt{\frac{1}{\left( \frac{2g\rho_0 z}{B_T} + 1 \right)}} \quad (4.VI.m)$$

The parameter  $\frac{2g\rho_0 z}{B_T}$  represents the dimensional length controlling the problem. For small length the expression in (4.VI.m) is similar to

$$f(x) = \sqrt{\frac{1}{x+1}} = 1 - \frac{x}{2} + \frac{3x^2}{8} - \frac{5x^3}{16} + \dots \quad (4.49)$$

hence it can be expressed as

$$\frac{\rho}{\rho_0} = 1 - \frac{2g\rho_0 z}{2B_T} + \frac{3g^2\rho_0^2 z^2}{8B_T^2} - \frac{5g^3\rho_0^3 z^3}{16B_T^3} + \dots \quad (4.VI.n)$$

---

End Solution

— — — — — Advance material can be skipped — — — — —

Example 4.7:

Water in deep sea undergoes compression due to hydrostatic pressure. That is the

density is a function of the depth. For constant bulk modulus, it was shown in "Fundamentals of Compressible Flow" by this author that the speed of sound is given by

$$c = \sqrt{\frac{B_T}{\rho}} \tag{4.VII.a}$$

Calculate the time it take for a sound wave to propagate perpendicularly to the surface to a depth  $D$  (perpendicular to the straight surface). Assume that no variation of the temperature exist. For the purpose of this exercise, the salinity can be completely ignored.

SOLUTION

The equation for the sound speed is taken here as correct for very local point. However, the density is different for every point since the density varies and the density is a function of the depth. The speed of sound at any depth point,  $x$ , is to be continue  
 ????????????????

$$c = \sqrt{\frac{B_T}{\rho_0 B_T}} = \sqrt{\frac{B_T - g \rho_0 z}{\rho_0}} \tag{4.VII.b}$$

The time the sound travel a small interval distance,  $dz$  is

$$d\tau = \frac{dz}{\sqrt{\frac{B_T - g \rho_0 z}{\rho_0}}} \tag{4.VII.c}$$

The time takes for the sound the travel the whole distance is the integration of infinitesimal time

$$t = \int_0^D \frac{dz}{\sqrt{\frac{B_T - g \rho_0 z}{\rho_0}}} \tag{4.VII.d}$$

The solution of equation (4.VII.d) is

$$t = \sqrt{\rho_0} \left( 2 \sqrt{B_T} - 2 \sqrt{B_T - D} \right) \tag{4.VII.e}$$

The time to travel according to the standard procedure is

$$t = \frac{D}{\sqrt{\frac{B_T}{\rho_0}}} = \frac{D \sqrt{\rho_0}}{\sqrt{B_T}} \tag{4.VII.f}$$

The ratio between the corrected estimated to the standard calculation is

$$\text{correction ratio} = \frac{\sqrt{\rho_0} \left( 2 \sqrt{B_T} - 2 \sqrt{B_T - D} \right)}{\frac{D \sqrt{\rho_0}}{\sqrt{B_T}}} \tag{4.VII.g}$$

---

End Solution

---

In Example 4.6 ratio of the density was expressed by equations (4.VI.1) while here the ratio is expressed by different equations. The difference between the two equations is the fact that Example 4.6 use the integral equation without using any “equation of state.” The method described in the Example 4.6 is more general which provided a simple solution<sup>6</sup>. The equation of state suggests that  $\partial P = g \rho_0 f(P) dz$  while the integral equation is  $\Delta P = g \int \rho dz$  where no assumption is made on the relationship between the pressure and density. However, the integral equation uses the fact that the pressure is function of location. The comparison between the two methods will be presented.

Example 4.8:

### 4.3.4 The Pressure Effects Due To Temperature Variations

#### 4.3.4.1 The Basic Analysis

There are situations when the main change of the density results from other effects. For example, when the temperature field is not uniform, the density is affected and thus the pressure is a location function (for example, the temperature in the atmosphere is assumed to be a linear with the height under certain conditions.). A bit more complicate case is when the gas is a function of the pressure and another parameter. Air can be a function of the temperature field and the pressure. For the atmosphere, it is commonly assumed that the temperature is a linear function of the height.

Here, a simple case is examined for which the temperature is a linear function of the height as

$$\frac{dT}{dh} = -C_x \quad (4.50)$$

where  $h$  here referred to height or distance. Hence, the temperature–distance function can be written as

$$T = Constant - C_x h \quad (4.51)$$

where the *Constant* is the integration constant which can be obtained by utilizing the initial condition. For  $h = 0$ , the temperature is  $T_0$  and using it leads to

Temp variations

$$T = T_0 - C_x h \quad (4.52)$$

Combining equation (4.52) with (4.11) results in

$$\frac{\partial P}{\partial h} = -\frac{g P}{R(T_0 - C_x h)} \quad (4.53)$$

---

<sup>6</sup>This author is not aware of the “equation of state” solution or the integral solution. If you know of any of these solutions or similar, please pass this information to this author.

Separating the variables in equation (4.53) and changing the formal  $\partial$  to the informal  $d$  to obtain

$$\frac{dP}{P} = -\frac{g dh}{R(T_0 - C_x h)} \quad (4.54)$$

Defining a new variable<sup>7</sup> as  $\xi = (T_0 - C_x h)$  for which  $\xi_0 = T_0 - C_x h_0$  and  $d/d\xi = -C_x d/dh$ . Using these definitions results in

$$\frac{dP}{P} = \frac{g}{RC_x} \frac{d\xi}{\xi} \quad (4.55)$$

After the integration of equation (4.54) and reusing (the reverse definitions) the variables transformed the result into

$$\ln \frac{P}{P_0} = \frac{g}{RC_x} \ln \frac{T_0 - C_x h}{T_0} \quad (4.56)$$

Or in a more convenient form as

Pressure in Atmosphere

$$\frac{P}{P_0} = \left( \frac{T_0 - C_x h}{T_0} \right)^{\left( \frac{g}{RC_x} \right)} \quad (4.57)$$

It can be noticed that equation (4.57) is a monotonous function which decreases with height because the term in the brackets is less than one. This situation is roughly representing the pressure in the atmosphere and results in a temperature decrease. It can be observed that  $C_x$  has a “double role” which can change the pressure ratio. Equation (4.57) can be approximated by two approaches/ideas. The first approximation for a small distance,  $h$ , and the second approximation for a small temperature gradient. It can be recalled that the following expansions are

$$\frac{P}{P_0} = \lim_{h \rightarrow 0} \left( 1 - \frac{C_x}{T_0} h \right)^{\frac{g}{RC_x}} = 1 - \underbrace{\frac{g h \rho_0}{T_0 R}}_{\text{correction factor}} - \frac{(R g C_x - g^2) h^2}{2 T_0^2 R^2} - \dots \quad (4.58)$$

Equation (4.58) shows that the first two terms are the standard terms (negative sign is as expected i.e. negative direction). The correction factor occurs only at the third term which is important for larger heights. It is worth to point out that the above statement has a qualitative meaning when additional parameter is added. However, this kind of analysis will be presented in the dimensional analysis chapter<sup>8</sup>.

<sup>7</sup>A colleague asked this author to insert this explanation for his students. If you feel that it is too simple, please, just ignore it.

<sup>8</sup>These concepts are very essential in all the thermo–fluid science. I am grateful to my adviser E.R.G. Eckert who was the pioneer of the dimensional analysis in heat transfer and was kind to show me some of his ideas.

The second approximation for small  $C_x$  is

$$\frac{P}{P_0} = \lim_{C_x \rightarrow 0} \left(1 - \frac{C_x}{T_0} h\right)^{\frac{g}{R C_x}} = e^{-\frac{g h}{R T_0}} - \frac{g h^2 C_x}{2 T_0^2 R} e^{-\frac{g h}{R T_0}} - \dots \quad (4.59)$$

Equation (4.59) shows that the correction factor (lapse coefficient),  $C_x$ , influences at only large values of height. It has to be noted that these equations (4.58) and (4.59) are not properly represented without the characteristic height. It has to be inserted to make the physical significance clearer.

Equation (4.57) represents only the pressure ratio. For engineering purposes, it is sometimes important to obtain the density ratio. This relationship can be obtained from combining equations (4.57) and (4.52). The simplest assumption to combine these equations is by assuming the ideal gas model, equation (2.25), to yield

$$\frac{\rho}{\rho_0} = \frac{P T_0}{P_0 T} = \underbrace{\left(1 - \frac{C_x h}{T_0}\right)^{\left(\frac{g}{R C_x}\right)}}_{\frac{P}{P_0}} \underbrace{\left(1 + \frac{C_x h}{T}\right)}_{\frac{T_0}{T}} \quad (4.60)$$

— — — — — Advance material can be skipped — — — — —

#### 4.3.4.2 The Stability Analysis

It is interesting to study whether this solution (4.57) is stable and if so under what conditions. Suppose that for some reason, a small slab of material moves from a layer at height,  $h$ , to layer at height  $h + dh$  (see Figure 4.11) What could happen? There are

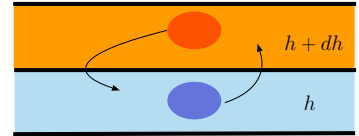

Fig. -4.11. Two adjoin layers for stability analysis.

two main possibilities one: the slab could return to the original layer or two: stay at the new layer (or even move further, higher heights). The first case is referred to as the stable condition and the second case referred to as the unstable condition. The whole system falls apart and does not stay if the analysis predicts unstable conditions. A weak wind or other disturbances can make the unstable system to move to a new condition.

This question is determined by the net forces acting on the slab. Whether these forces are toward the original layer or not. The two forces that act on the slab are the gravity force and the surroundings pressure (buoyant forces). Clearly, the slab is in equilibrium with its surroundings before the movement (not necessarily stable). Under equilibrium, the body forces that acting on the slab are equal to zero. That is, the surroundings "pressure" forces (buoyancy forces) are equal to gravity forces. The buoyancy forces are proportional to the ratio of the density of the slab to surrounding layer density. Thus, the stability question is whether the slab density from layer  $h$ ,  $\rho'(h)$  undergoing a free expansion is higher or lower than the density of the layer  $h + dh$ . If  $\rho'(h) > \rho(h + dh)$  then the situation is stable. The term  $\rho'(h)$  is slab from layer  $h$  that had undergone the free expansion.

The reason that the free expansion is chosen to explain the process that the slab undergoes when it moves from layer  $h$  to layer  $h + dh$  is because it is the simplest. In reality, the free expansion is not far way from the actual process. The two processes that occurred here are thermal and the change of pressure (at the speed of sound). The thermal process is in the range of [cm/sec] while the speed of sound is about 300 [m/sec]. That is, the pressure process is about thousands times faster than the thermal process. The second issue that occurs during the "expansion" is the shock (in the reverse case  $[h + dh] \rightarrow h$ ). However, this shock is insignificant (check book on Fundamentals of Compressible Flow Mechanics by this author on the French problem).

The slab density at layer  $h + dh$  can be obtained using equation (4.60) as following

$$\frac{\rho(h + dh)}{\rho(h)} = \frac{P T_0}{P_0 T} = \left(1 - \frac{C_x dh}{T_0}\right)^{\left(\frac{g}{R C_x}\right)} \left(1 + \frac{C_x dh}{T}\right) \quad (4.61)$$

The pressure and temperature change when the slab moves from layer at  $h$  to layer  $h + dh$ . The process, under the above discussion and simplifications, can be assumed to be adiabatic (that is, no significant heat transfer occurs in the short period of time). The little slab undergoes isentropic expansion as following for which (see equation (2.25))

$$\frac{\rho'(h + dh)}{\rho(h)} = \left(\frac{P'(h + dh)}{P(h)}\right)^{1/k} \quad (4.62)$$

When the symbol  $'$  denotes the slab that moves from layer  $h$  to layer  $h + dh$ . The pressure ratio is given by equation (4.57) but can be approximated by equation (4.58) and thus

$$\frac{\rho'(h + dh)}{\rho(h)} = \left(1 - \frac{g dh}{T(h) R}\right)^{1/k} \quad (4.63)$$

Again using the ideal gas model for equation (4.64) transformed into

$$\frac{\rho'(h + dh)}{\rho(h)} = \left(1 - \frac{\rho g dh}{P}\right)^{1/k} \quad (4.64)$$

Expanding equation (4.64) in Taylor series results in

$$\left(1 - \frac{\rho g dh}{P}\right)^{1/k} = 1 - \frac{g \rho dh}{P k} - \frac{(g^2 \rho^2 k - g^2 \rho^2) dh^2}{2 P^2 k^2} - \dots \quad (4.65)$$

The density at layer  $h + dh$  can be obtained from (4.61) and then it is expanded in Taylor series as

$$\frac{\rho(h + dh)}{\rho(h)} = \left(1 - \frac{C_x dh}{T_0}\right)^{\left(\frac{g}{R C_x}\right)} \left(1 + \frac{C_x dh}{T}\right) \sim 1 - \left(\frac{g \rho}{P} - \frac{C_x}{T}\right) dh + \dots \quad (4.66)$$

The comparison of the right hand terms of equations (4.66) and (4.65) provides the conditions to determine the stability. From a mathematical point of view, to keep the inequality for a small  $dh$  only the first term need to be compared as

$$\frac{g \rho}{P k} > \frac{g \rho}{P} - \frac{C_x}{T} \quad (4.67)$$

After rearrangement of the inequality (4.67) and using the ideal gas identity, it transformed to

$$\begin{aligned} \frac{C_x}{T} &> \frac{(k-1)g\rho}{kP} \\ C_x &< \frac{k-1}{k} \frac{g}{R} \end{aligned} \quad (4.68)$$

The analysis shows that the maximum amount depends on the gravity and gas properties. It should be noted that this value should be changed a bit since the  $k$  should be replaced by polytropic expansion  $n$ . When lapse rate  $C_x$  is equal to the right hand side of the inequality, it is said that situation is neutral. However, one has to bear in mind that this analysis only provides a range and isn't exact. Thus, around this value additional analysis is needed <sup>9</sup>.

One of the common question this author has been asked is about the forces of continuation. What is the source of the force(s) that make this situation when unstable continue to be unstable? Supposed that the situation became unstable and the layers have been exchanged, would the situation become stable now? One has to remember that temperature gradient forces continuous heat transfer which the source temperature change after the movement to the new layer. Thus, the unstable situation is continuously unstable.

### 4.3.5 Gravity Variations Effects on Pressure and Density

Until now the study focus on the change of density and pressure of the fluid. Equation (4.11) has two terms on the right hand side, the density,  $\rho$  and the body force,  $g$ . The body force was assumed until now to be constant. This assumption must be deviated when the distance from the body source is significantly change. At first glance, the body force is independent of the fluid. The source of the gravity force in gas is another body, while the gravity force source in liquid can be the liquid itself. Thus, the discussion is separated into two different issues. The issues of magnetohydrodynamics are too advance for undergraduate student and therefore, will not be introduced here.

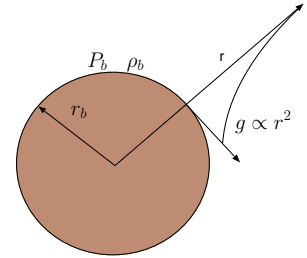

Fig. -4.12. The varying gravity effects on density and pressure.

<sup>9</sup>The same issue of the floating ice. See example for the floating ice in cup.



#### 4.3.5.1 Ideal Gas in Varying Gravity

In physics, it was explained that the gravity is a function of the distance from the center of the planet/body. Assuming that the pressure is affected by this gravity/body force. The gravity force is reversely proportional to  $r^2$ . The gravity force can be assumed that for infinity,  $r \rightarrow \infty$  the pressure is about zero. Again, equation (4.11) can be used (semi one directional situation) when  $r$  is used as direction and thus

$$\frac{\partial P}{\partial r} = -\rho \frac{G}{r^2} \quad (4.69)$$

where  $G$  denotes the general gravity constant. The regular method of separation is employed to obtain

$$\int_{P_b}^P \frac{dP}{P} = -\frac{G}{RT} \int_{r_b}^r \frac{dr}{r^2} \quad (4.70)$$

where the subscript  $b$  denotes the conditions at the body surface. The integration of equation (4.70) results in

$$\ln \frac{P}{P_b} = -\frac{G}{RT} \left( \frac{1}{r_b} - \frac{1}{r} \right) \quad (4.71)$$

Or in a simplified form as

$$\frac{\rho}{\rho_b} = \frac{P}{P_b} = e^{-\frac{G}{RT} \frac{r-r_b}{r r_b}} \quad (4.72)$$

Equation (4.72) demonstrates that the pressure is reduced with the distance. It can be noticed that for  $r \rightarrow r_b$  the pressure is approaching  $P \rightarrow P_b$ . This equation confirms that the density in outer space is zero  $\rho(\infty) = 0$ . As before, equation (4.72) can be expanded in Taylor series as

$$\frac{\rho}{\rho_b} = \frac{P}{P_b} = \underbrace{1 - \frac{G(r-r_b)}{RT}}_{\text{standard}} - \underbrace{\frac{(2GRT + G^2 r_b)(r-r_b)^2}{2r_b(RT)^2}}_{\text{correction factor}} + \dots \quad (4.73)$$

Notice that  $G$  isn't our beloved and familiar  $g$  and also that  $G r_b / RT$  is a dimensionless number (later in dimensionless chapter about it and its meaning).

#### 4.3.5.2 Real Gas in Varying Gravity

The regular assumption of constant compressibility,  $Z$ , is employed. It has to remember when this assumption isn't accurate enough, numerical integration is a possible solution. Thus, equation (4.70) is transformed into

$$\int_{P_b}^P \frac{dP}{P} = -\frac{G}{ZRT} \int_{r_b}^r \frac{dr}{r^2} \quad (4.74)$$

With the same process as before for ideal gas case, one can obtain

$$\frac{\rho}{\rho_b} = \frac{P}{P_b} = e^{-\frac{G}{ZRT} \frac{r-r_b}{r r_b}} \quad (4.75)$$

Equation (4.72) demonstrates that the pressure is reduced with the distance. It can be observed that for  $r \rightarrow r_b$  the pressure is approaching  $P \rightarrow P_b$ . This equation confirms that the density in outer space is zero  $\rho(\infty) = 0$ . As before Taylor series for equation (4.72) is

$$\frac{\rho}{\rho_b} = \frac{P}{P_b} = \underbrace{1 - \frac{G(r-r_b)}{ZRT}}_{\text{standard}} - \underbrace{\frac{(2GZRT + G^2 r_b)(r-r_b)^2}{2r_b(ZRT)^2}}_{\text{correction factor}} + \dots \quad (4.76)$$

It can be noted that compressibility factor can act as increase or decrease of the ideal gas model depending on whether it is above one or below one. This issue is related to Pushka equation that will be discussed later.

### 4.3.5.3 Liquid Under Varying Gravity

For comparison reason consider the deepest location in the ocean which is about 11,000 [m]. If the liquid “equation of state” (4.40) is used with the hydrostatic fluid equation results in

$$\frac{\partial P}{\partial r} = -\rho_0 e^{\frac{P-P_0}{B_T}} \frac{G}{r^2} \quad (4.77)$$

which the solution of equation (4.77) is

$$e^{\frac{P_0-P}{B_T}} = Constant - \frac{B_T g \rho_0}{r} \quad (4.78)$$

Since this author is not aware to which practical situation this solution should be applied, it is left for the reader to apply according to problem, if applicable.

### 4.3.6 Liquid Phase

While for most practical purposes, the Cartesian coordinates provides sufficient treatment to the problem, there are situations where the spherical coordinates must be considered and used.

Derivations of the fluid static in spherical coordinates are

Pressure Spherical Coordinates

$$\frac{1}{r^2} \frac{d}{dr} \left( \frac{r^2}{\rho} \frac{dP}{dr} \right) + 4\pi G\rho = 0 \quad (4.79)$$

Or in a vector form as

$$\nabla \cdot \left( \frac{1}{\rho} \nabla P \right) + 4\pi G\rho = 0 \quad (4.80)$$

## 4.4 Fluid in a Accelerated System

Up to this stage, body forces were considered as one-dimensional. In general, the linear acceleration have three components as opposed to the previous case of only one. However, the previous derivations can be easily extended. Equation (4.8) can be transformed into a different coordinate system where the main coordinate is in the direction of the effective gravity. Thus, the previous method can be used and there is no need to solve new three (or two) different equations. As before, the constant pressure plane is perpendicular to the direction of the effective gravity. Generally the acceleration is divided into two categories: linear and angular and they will be discussed in this order.

### 4.4.1 Fluid in a Linearly Accelerated System

For example, in a two dimensional system, for the effective gravity

$$g_{eff} = a \hat{i} + g \hat{k} \quad (4.81)$$

where the magnitude of the effective gravity is

$$|g_{eff}| = \sqrt{g^2 + a^2} \quad (4.82)$$

and the angle/direction can be obtained from

$$\tan \beta = \frac{a}{g} \quad (4.83)$$

Perhaps the best way to explain the linear acceleration is by examples. Consider the following example to illustrate the situation.

Example 4.9:

*A tank filled with liquid is accelerated at a constant acceleration. When the acceleration is changing from the right to the left, what happened to the liquid surface? What is the relative angle of the liquid surface for a container in an accelerated system of  $a = 5[m/sec]$ ?*

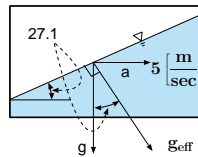

Fig. -4.13. The effective gravity is for accelerated cart.

#### SOLUTION

This question is one of the traditional question of the fluid static and is straight forward. The solution is obtained by finding the effective angle body force. The effective angle is obtained by adding vectors. The change of the acceleration from the right to left is

like subtracting vector (addition negative vector). This angle/direction can be found using the following

$$\tan^{-1} \beta = \tan^{-1} \frac{a}{g} = \frac{5}{9.81} \sim 27.01^\circ$$

The magnitude of the effective acceleration is

$$|g_{eff}| = \sqrt{5^2 + 9.81^2} = 11.015[m/sec^2]$$

---

End Solution

---

**Example 4.10:**

*A cart partially filled with liquid and is sliding on an inclined plane as shown in Figure 4.14. Calculate the shape of the surface. If there is a resistance, what will be the angle? What happen when the slope angle is straight (the cart is dropping straight down)?*

SOLUTION

**(a)**

The angle can be found when the acceleration of the cart is found. If there is no resistance, the acceleration in the cart direction is determined from

$$a = g \sin \beta \quad (4.84)$$

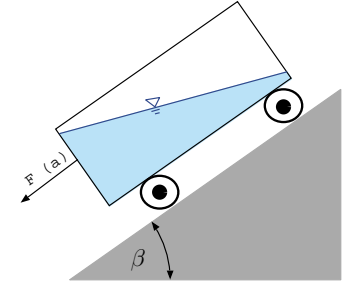

The effective body force is acting perpendicular to the slope. Thus, the liquid surface is parallel to the surface of the inclination surface. *Fig. -4.14. A cart slide on inclined plane.*

---

End Solution

---

**(b)**

In case of resistance force (either of friction due to the air or resistance in the wheels) reduces the acceleration of the cart. In that case the effective body moves closer to the gravity forces. The net body force depends on the mass of the liquid and the net acceleration is

$$a = g - \frac{F_{net}}{m} \quad (4.85)$$

The angle of the surface,  $\alpha < \beta$ , is now

$$\tan \alpha = \frac{g - \frac{F_{net}}{m}}{g \cos \beta} \quad (4.86)$$

**(c)**

#### 4.4. FLUID IN A ACCELERATED SYSTEM

In the case when the angle of the inclination turned to be straight (direct falling) the effective body force is zero. The pressure is uniform in the tank and no pressure difference can be found. So, the pressure at any point in the liquid is the same and equal to the atmospheric pressure.

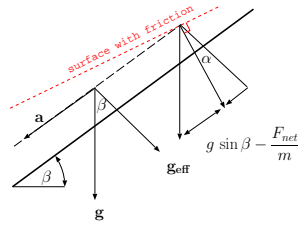

95

Fig. -4.15. Forces diagram of cart sliding on inclined plane.

#### 4.4.2 Angular Acceleration Systems: Constant Density

For simplification reasons, the first case deals with a rotation in a perpendicular to the gravity. That effective body force can be written as

$$\mathbf{g}_{eff} = -g \hat{k} + \omega^2 r \hat{r} \quad (4.87)$$

The lines of constant pressure are not straight lines but lines of parabolic shape. The angle of the line depends on the radius as

$$\frac{dz}{dr} = -\frac{g}{\omega^2 r} \quad (4.88)$$

Equation (4.88) can be integrated as

$$z - z_0 = \frac{\omega^2 r^2}{2g} \quad (4.89)$$

Notice that the integration constant was substituted by  $z_0$ . The constant pressure will be along

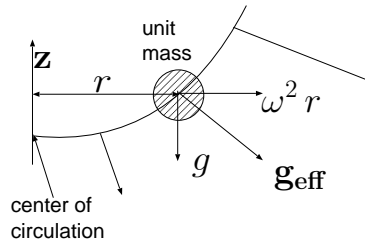

Fig. -4.16. Schematic to explain the angular angle.

#### Angular Acceleration System

$$P - P_0 = \rho g \left[ (z_0 - z) + \frac{\omega^2 r^2}{2g} \right] \quad (4.90)$$

To illustrate this point, example 4.11 is provided.

#### Example 4.11:

A "U" tube with a length of  $(1+x)L$  is rotating at angular velocity of  $\omega$ . The center of rotation is a distance,  $L$  from the "left" hand side. Because the asymmetrical nature of the problem there is difference in the heights in the U tube arms of  $S$  as shown in Figure 4.17. Expresses the relationship between the different parameters of the problem.

#### SOLUTION

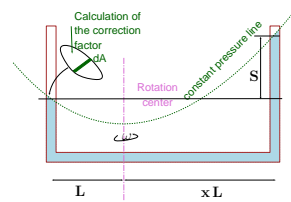

Fig. -4.17. Schematic angular angle to explain example 4.11.

It is first assumed that the height is uniform at the tube (see for the open question on this assumption). The pressure at the interface at the two sides of the tube is same. Thus, equation (4.89) represents the pressure line. Taking the "left" wing of U tube

$$\underbrace{\text{change in } z \text{ direction}}_{z_l - z_0} = \underbrace{\text{change in } r \text{ direction}}_{\frac{\omega^2 L^2}{2g}}$$

The same can be said for the other side

$$z_r - z_0 = \frac{\omega^2 x^2 L^2}{2g}$$

Thus subtracting the two equations above from each other results in

$$z_r - z_l = \frac{L \omega^2 (1 - x^2)}{2g}$$

It can be noticed that this kind of equipment can be used to find the gravity.

---

End Solution

Example 4.12:

Assume that the diameter of the U tube is  $R_t$ . What will be the correction factor if the curvature in the liquid in the tube is taken in to account. How would you suggest to define the height in the tube?

SOLUTION

In Figure 4.17 shows the infinitesimal area used in these calculations. The distance of the infinitesimal area from the rotation center is  $r$ . The height of the infinitesimal area is  $z$ . Notice that the curvature in the two sides are different from each other. The volume above the lower point is  $V$  which is only a function of the geometry.

---

End Solution

Example 4.13:

In the U tube in example 4.11 is rotating with upper part height of  $\ell$ . At what rotating

velocity liquid start to exit the U tube? If the rotation of U tube is exactly at the center, what happen the rotation approach very large value?

— — — — — *Advance material can be skipped* — — — — —

### 4.4.3 Fluid Statics in Geological System

*This author would like to express his gratitude to Ralph Menikoff for suggesting this topic.*

In geological systems such as the Earth provide cases to be used for fluid static for estimating pressure. It is common in geology to assume that the Earth is made of several layers. If this assumption is accepted, these layers assumption will be used to do some estimates. The assumption states that the Earth is made from the following layers: solid inner core, outer core, and two layers in the liquid phase with a thin crust. For the purpose of this book, the interest is the calculate the pressure at bottom of the liquid phase. This explanation is provided to understand how to use the

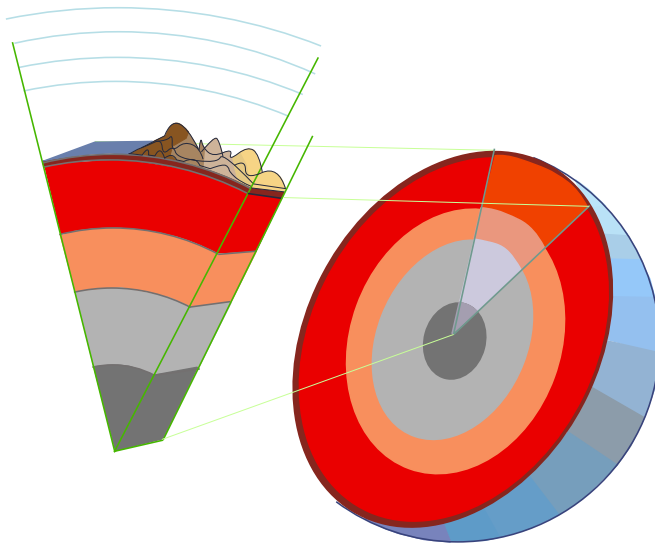

Fig. -4.18. Earth layers not to scale.<sup>10</sup>

bulk modulus and the effect of rotation. In reality, there might be an additional effects which affecting the situation but these effects are not the concern of this discussion.

Two different extremes can recognized in fluids between the outer core to the crust. In one extreme, the equator rotation plays the most significant role. In the

<sup>10</sup>The image was drawn by Shoshana Bar-Meir, inspired from image made by user Surachit

other extreme, at the north–south poles, the rotation effect is demished since the radius of rotation is relatively very small (see Figure 4.19). In that case, the pressure at the bottom of the liquid layer can be estimated using the equation (4.45) or in approximation of equation (4.VI.j). In this case it also can be noticed that  $g$  is a function of  $r$ .

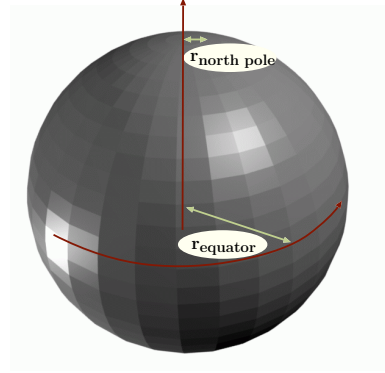

Fig. -4.19. Illustration of the effects of the different radii on pressure on the solid core.

If the bulk modulus is assumed constant (for simplicity), the governing equation can be constructed starting with equation (1.28). The approximate definition of the bulk modulus is

$$B_T = \frac{\rho \Delta P}{\Delta \rho} \implies \Delta \rho = \frac{\rho \Delta P}{B_T} \quad (4.91)$$

Using equation to express the pressure difference (see Example 4.6 for details explanation) as

$$\rho(r) = \frac{\rho_0}{1 - \int_{R_0}^r \frac{g(r)\rho(r)}{B_T(r)} dr} \quad (4.92)$$

In equation (4.92) it is assumed that  $B_T$  is a function of pressure and the pressure is a function of the location. Thus, the bulk modulus can be written as a function of the location radius,  $r$ .

Again, for simplicity the bulk modulus is assumed to be constant. Hence,

$$\rho(r) = \frac{\rho_0}{1 - \frac{1}{B_T} \int_{R_0}^r g(r)\rho(r) dr} \quad (4.93)$$

The governing equation (4.93) can be written using the famous relation for the gravity<sup>11</sup> as

$$\frac{\rho_0}{\rho(r)} = 1 - \frac{1}{B_T} \int_{R_0}^r G r \rho(r) dr \quad (4.94)$$

Equation (4.94) is a relatively simple (Fredholm) integral equation. The solution of this equation obtained by differentiation as

$$\frac{\rho_0}{\rho^2} \frac{d\rho}{dr} + G r \rho = 0 \quad (4.95)$$

Under variables separation technique, the equation changes to

$$\int_{\rho_0}^{\rho} \frac{\rho_0}{\rho^3} d\rho = - \int_{R_0}^r G r dr \quad (4.96)$$

<sup>11</sup>The solution for the field with relation of  $1/r^2$  was presented in the early version. This solution was replaced with a function of gravity  $g \propto r$ . The explanation of this change can be found at <http://www.physicsforums.com/showthread.php?t=203955>.



The solution of equation (4.96) is

$$\frac{\rho_0}{z} \left( \frac{1}{\rho_0^2} - \frac{1}{\rho^2} \right) = \frac{G}{z} (R_0^2 - r^2) \quad (4.97)$$

or

$$\rho = \sqrt{\frac{1}{\left( \frac{1}{\rho_0^2} - \frac{G}{\rho_0} (R_0^2 - r^2) \right)}} \Rightarrow \frac{\rho}{\rho_0} = \sqrt{\frac{1}{\left( 1 - \frac{G R_0^2}{\rho_0} \left( 1 - \frac{r^2}{R_0^2} \right) \right)}} \quad (4.98)$$

These equations, (4.97) and (4.98), referred to as the expanded Pushka equation. The pressure can be calculated since the density is found and using equation (1.28) as

$$\Delta P = \int_{R_0}^r \rho(r) g(r) dr = \int_{R_0}^r \rho \overbrace{G r}^{g(r)} \rho dr = \int_{R_0}^r \rho^2 G r dr \quad (4.99)$$

or explicitly

$$\Delta P = \int_{R_0}^r \frac{\rho_0^2 G r dr}{\left( \frac{1}{\rho_0^2} - \frac{2G}{\rho_0} \left( \frac{1}{R_0} - \frac{1}{r} \right) \right)} \quad (4.100)$$

The integral can be evaluated numerically or analytically as

$$\Delta P = \rho_0^2 G \left( \frac{4 \rho_0^4 G^2 R_0^3 \log(r (R_0 - 2 \rho_0 G) + 2 \rho_0 G R_0)}{R_0^3 - 6 \rho_0 G R_0^2 + 12 \rho_0^2 G^2 R_0 - 8 \rho_0^3 G^3} + \frac{r^2 (\rho_0^2 R_0^2 - 2 \rho_0^3 G R_0) - 4 r \rho_0^3 G R_0^2}{2 R_0^2 - 8 \rho_0 G R_0 + 8 \rho_0^2 G^2} \right) \quad (4.101)$$

The related issue to this topic is, the pressure at the equator when the rotation is taken into account. The rotation affects the density since the pressure changes. Thus, mathematical complications caused by the coupling creates additionally difficulty. The integral in equation (4.94) has to include the rotation effects. It can be noticed that the rotation acts in the opposite direction to the gravity. The pressure difference is

$$\Delta P = \int_{R_0}^r \rho (g(r) - \omega r^2) dr \quad (4.102)$$

Thus the approximated density ratio can be written as

$$\frac{\rho_0}{\rho} = 1 - \frac{1}{B_T} \int_{R_0}^r \rho (\rho G r - \omega r^2) dr \quad (4.103)$$

Taking derivative of the two sides with respect to  $r$  results in

$$-\frac{\rho_0}{\rho^3} \frac{d\rho}{dr} = -\frac{1}{B_T} (\rho G r - \omega r^2) \quad (4.104)$$

Integrating equation (4.104)

$$\frac{\rho_0}{2\rho^2} = \frac{1}{B_T} \left( \frac{-G}{r} - \frac{\omega r^3}{3} \right) \quad (4.105)$$

Where the pressure is obtained by integration as previously was done. The conclusion is that the pressure at the “equator” is substantially lower than the pressure in the north or the south “poles” of the solid core. The pressure difference is due to the large radius. In the range between the two extreme, the effect of rotation is reduced because the radius is reduced. In real liquid, the flow is much more complicated because it is not stationary but have cells in which the liquid flows around. Nevertheless, this analysis gives some indication on the pressure and density in the core.

— — — — — *End Advance material* — — — — —

## 4.5 Fluid Forces on Surfaces

The forces that fluids (at static conditions) extracts on surfaces are very important for engineering purposes. This section deals with these calculations. These calculations are divided into two categories, straight surfaces and curved surfaces.

### 4.5.1 Fluid Forces on Straight Surfaces

A motivation is needed before going through the routine of derivations. Initially, a simple case will be examined. Later, how the calculations can be simplified will be shown.

Example 4.14:

Consider a rectangular shape gate as shown in Figure 4.20. Calculate the minimum forces,  $F_1$  and  $F_2$  to maintain the gate in position. Assuming that the atmospheric pressure can be ignored.

SOLUTION

The forces can be calculated by looking at the moment around point “O.” The element of moment is  $a d\xi$  for the width of the gate and is

$$dM = \overbrace{P}^{dF} \underbrace{a d\xi}_{dA} (\ell + \xi)$$

The pressure,  $P$  can be expressed as a function  $\xi$  as the following

$$P = g\rho(\ell + \xi)\sin\beta$$

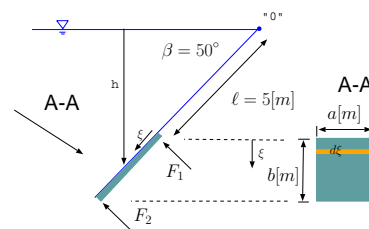

Fig. -4.20. Rectangular area under pressure.

The liquid total moment on the gate is

$$M = \int_0^b g \rho (\ell + \xi) \sin \beta a d\xi (\ell + \xi)$$

The integral can be simplified as

$$M = g a \rho \sin \beta \int_0^b (\ell + \xi)^2 d\xi \quad (4.106)$$

The solution of the above integral is

$$M = g \rho a \sin \beta \left( \frac{3 b \ell^2 + 3 b^2 \ell + b^3}{3} \right)$$

This value provides the moment that  $F_1$  and  $F_2$  should extract. Additional equation is needed. It is the total force, which is

$$F_{total} = \int_0^b g \rho (\ell + \xi) \sin \beta a d\xi$$

The total force integration provides

$$F_{total} = g \rho a \sin \beta \int_0^b (\ell + \xi) d\xi = g \rho a \sin \beta \left( \frac{2 b \ell + b^2}{2} \right)$$

The forces on the gate have to provide

$$F_1 + F_2 = g \rho a \sin \beta \left( \frac{2 b \ell + b^2}{2} \right)$$

Additionally, the moment of forces around point "O" is

$$F_1 \ell + F_2 (\ell + b) = g \rho a \sin \beta \left( \frac{3 b \ell^2 + 3 b^2 \ell + b^3}{3} \right)$$

The solution of these equations is

$$F_1 = \frac{(3 \ell + b) a b g \rho \sin \beta}{6}$$

$$F_2 = \frac{(3 \ell + 2 b) a b g \rho \sin \beta}{6}$$

End Solution

The above calculations are time consuming and engineers always try to make life simpler. Looking at the above calculations, it can be observed that there is a moment of area in equation (4.106) and

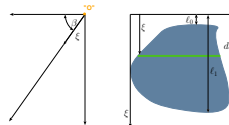

Fig. -4.21. Schematic of submerged area to explain the center forces and moments.

also a center of area. These concepts have been introduced in Chapter 3. Several represented areas for which moment of inertia and center of area have been tabulated in Chapter 3. These tabulated values can be used to solve this kind of problems.

**Symmetrical Shapes**

Consider the two-dimensional symmetrical area that are under pressure as shown in Figure 4.21. The symmetry is around any axes parallel to axis  $x$ . The total force and moment that the liquid extracting on the area need to be calculated. First, the force is

$$F = \int_A P dA = \int (P_{atmos} + \rho g h) dA = A P_{atmos} + \rho g \int_{\ell_0}^{\ell_1} \overbrace{(\xi + \ell_0) \sin \beta}^{h(\xi)} dA \tag{4.107}$$

In this case, the atmospheric pressure can include any additional liquid layer above layer “touching” area. The “atmospheric” pressure can be set to zero.

The boundaries of the integral of equation (4.107) refer to starting point and ending points not to the start area and end area. The integral in equation (4.107) can be further developed as

$$F_{total} = A P_{atmos} + \rho g \sin \beta \left( \ell_0 A + \overbrace{\int_{\ell_0}^{\ell_1} \xi dA}^{x_c A} \right) \tag{4.108}$$

In a final form as

Total Force in Inclined Surface

$$F_{total} = A [P_{atmos} + \rho g \sin \beta (\ell_0 + x_c)] \tag{4.109}$$

The moment of the liquid on the area around point “O” is

$$M_y = \int_{\xi_0}^{\xi_1} P(\xi) \xi dA \tag{4.110}$$

$$M_y = \int_{\xi_0}^{\xi_1} (P_{atmos} + \rho g \overbrace{h(\xi)}^{\xi \sin \beta}) \xi dA \tag{4.111}$$

Or separating the parts as

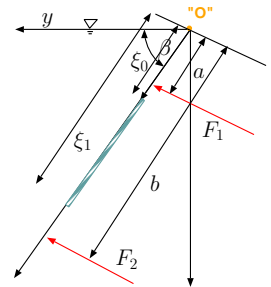

Fig. -4.22. The general forces acting on submerged area.

$$M_y = P_{atmos} \overbrace{\int_{\xi_0}^{\xi_1} \xi dA}^{x_c A} + g \rho \sin \beta \overbrace{\int_{\xi_0}^{\xi_1} \xi^2 dA}^{I_{x'x'}} \quad (4.112)$$

The moment of inertia,  $I_{x'x'}$ , is about the axis through point “O” into the page. Equation (4.112) can be written in more compact form as

$$\text{Total Moment in Inclined Surface} \\ M_y = P_{atmos} x_c A + g \rho \sin \beta I_{x'x'} \quad (4.113)$$

Example 4.14 can be generalized to solve any two forces needed to balance the area/gate. Consider the general symmetrical body shown in figure 4.22 which has two forces that balance the body. Equations (4.109) and (4.113) can be combined the moment and force acting on the general area. If the “atmospheric pressure” can be zero or include additional layer of liquid. The forces balance reads

$$F_1 + F_2 = A [P_{atmos} + \rho g \sin \beta (\ell_0 + x_c)] \quad (4.114)$$

and moments balance reads

$$F_1 a + F_2 b = P_{atmos} x_c A + g \rho \sin \beta I_{x'x'} \quad (4.115)$$

The solution of these equations is

$$F_1 = \frac{\left[ \left( \rho \sin \beta - \frac{P_{atmos}}{g b} \right) x_c + \ell_0 \rho \sin \beta + \frac{P_{atmos}}{g} \right] b A - I_{x'x'} \rho \sin \beta}{g (b - a)} \quad (4.116)$$

and

$$F_2 = \frac{I_{x'x'} \rho \sin \beta - \left[ \left( \rho \sin \beta - \frac{P_{atmos}}{g a} \right) x_c + \ell_0 \rho \sin \beta + \frac{P_{atmos}}{g} \right] a A}{g (b - a)} \quad (4.117)$$

In the solution, the forces can be negative or positive, and the distance  $a$  or  $b$  can be positive or negative. Additionally, the atmospheric pressure can contain either an additional liquid layer above the “touching” area or even atmospheric pressure simply can be set up to zero. In symmetrical area only two forces are required since the moment is one dimensional. However, in non-symmetrical area there are two different moments and therefore three forces are required. Thus, additional equation is required. This equation is for the additional moment around the  $x$  axis (see for explanation in Figure 4.23). The moment around the  $y$  axis is given by equation (4.113) and the total force is given by (4.109). The moment around the  $x$  axis (which was arbitrary chosen) should be

$$M_x = \int_A y P dA \quad (4.118)$$

Substituting the components for the pressure transforms equation (4.118) into

$$M_x = \int_A y (P_{atmos} + \rho g \xi \sin \beta) dA \quad (4.119)$$

The integral in equation (4.118) can be written as

$$M_x = P_{atmos} \overbrace{\int_A y dA}^{Ay_c} + \rho g \sin \beta \overbrace{\int_A \xi y dA}^{I_{x'y'}} \quad (4.120)$$

The compact form can be written as

Moment in Inclined Surface

$$M_x = P_{atmos} A y_c + \rho g \sin \beta I_{x'y'} \quad (4.121)$$

The product of inertia was presented in Chapter 3. These equations (4.109), (4.113) and (4.121) provide the base for solving any problem for straight area under pressure with uniform density. There are many combinations of problems (e.g. two forces and moment) but no general solution is provided. Example to illustrate the use of these equations is provided.

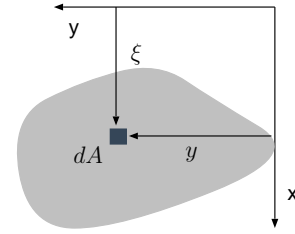

Fig. -4.23. The general forces acting on non symmetrical straight area.

Example 4.15:

Calculate the forces which required to balance the triangular shape shown in the Figure 4.24.

#### SOLUTION

The three equations that needs to be solved are

$$F_1 + F_2 + F_3 = F_{total} \quad (4.122)$$

The moment around  $x$  axis is

$$F_1 b = M_y \quad (4.123)$$

The moment around  $y$  axis is

$$F_1 \ell_1 + F_2 (a + \ell_0) + F_3 \ell_0 = M_x \quad (4.124)$$

The right hand side of these equations are given before in equations (4.109), (4.113) and (4.121).

The moment of inertia of the triangle around  $x$  is made of two triangles (as shown in the Figure (4.24) for triangle 1 and 2). Triangle 1 can be calculated as the moment of inertia around its center which is  $\ell_0 + 2 * (\ell_1 - \ell_0) / 3$ . The height of triangle 1 is  $(\ell_1 - \ell_0)$  and its width  $b$  and thus, moment of inertia about its center is  $I_{xx} = b(\ell_1 - \ell_0)^3 / 36$ . The moment of inertia for triangle 1 about  $y$  is

$$I_{xx1} = \frac{b(\ell_1 - \ell_0)^3}{36} + \overbrace{\frac{b(\ell_1 - \ell_0)}{3}}^{A_1} \overbrace{\left(\ell_0 + \frac{2(\ell_1 - \ell_0)}{3}\right)^2}^{\Delta x_1^2}$$

The height of the triangle 2 is  $a - (\ell_1 - \ell_0)$  and its width  $b$  and thus, the moment of inertia about its center is

$$I_{xx2} = \frac{b[a - (\ell_1 - \ell_0)]^3}{36} + \overbrace{\frac{b[a - (\ell_1 - \ell_0)]}{3}}^{A_2} \overbrace{\left(\ell_1 + \frac{[a - (\ell_1 - \ell_0)]}{3}\right)^2}^{\Delta x_2^2}$$

and the total moment of inertia

$$I_{xx} = I_{xx1} + I_{xx2}$$

The product of inertia of the triangle can be obtain by integration. It can be noticed that upper line of the triangle is  $y = \frac{(\ell_1 - \ell_0)x}{b} + \ell_0$ . The lower line of the triangle is  $y = \frac{(\ell_1 - \ell_0 - a)x}{b} + \ell_0 + a$ .

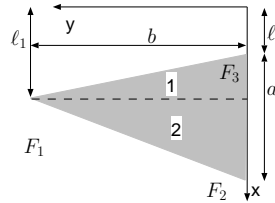

Fig. -4.24. The general forces acting on a non symmetrical straight area.

$$I_{xy} = \int_0^b \left[ \int_{\frac{(\ell_1 - \ell_0 - a)x}{b} + \ell_0 + a}^{\frac{(\ell_1 - \ell_0)x}{b} + \ell_0} xy \, dx \right] dy = \frac{2ab^2\ell_1 + 2ab^2\ell_0 + a^2b^2}{24}$$

The solution of this set equations is

$$F_1 = \left[ \frac{ab}{3} \right] \frac{(g(6\ell_1 + 3a) + 6g\ell_0) \rho \sin \beta + 8P_{atmos}}{24},$$

$$\frac{F_2}{\left[ \frac{ab}{3} \right]} = - \frac{\left( (3\ell_1 - 14a) - \ell_0 \left( \frac{12\ell_1}{a} - 27 \right) + \frac{12\ell_0^2}{a} \right) g \rho \sin \beta}{72} - \frac{\left( \left( \frac{24\ell_1}{a} - 24 \right) + \frac{48\ell_0}{a} \right) P_{atmos}}{72},$$

$$\frac{F_3}{\left[ \frac{ab}{3} \right]} = \frac{\left( \left( a - \frac{15\ell_1}{a} \right) + \ell_0 \left( 27 - \frac{12\ell_1}{a} \right) + \frac{12\ell_0^2}{a} \right) g \rho \sin \beta}{72} + \frac{\left( \left( \frac{24\ell_1}{a} + 24 \right) + \frac{48\ell_0}{a} \right) P_{atmos}}{72}$$

#### 4.5.1.1 Pressure Center

In the literature, pressure centers are commonly defined. These definitions are mathematical in nature and has physical meaning of equivalent force that will act through this center. The definition is derived or obtained from equation (4.113) and equation (4.121). The pressure center is the distance that will create the moment with the hydrostatic force on point "O." Thus, the pressure center in the  $x$  direction is

$$x_p = \frac{1}{F} \int_A x P dA \quad (4.125)$$

In the same way, the pressure center in the  $y$  direction is defined as

$$y_p = \frac{1}{F} \int_A y P dA \quad (4.126)$$

To show relationship between the pressure center and the other properties, it can be found by setting the atmospheric pressure and  $\ell_0$  to zero as following

$$x_p = \frac{g \rho \sin \beta I_{x'x'}}{A \rho g \sin \beta x_c} \quad (4.127)$$

Expanding  $I_{x'x'}$  according to equation (3.17) results in

$$x_p = \frac{I_{xx}}{x_c A} + x_c \quad (4.128)$$

and in the same fashion in  $y$  direction

$$y_p = \frac{I_{yy}}{y_c A} + y_c \quad (4.129)$$

It has to emphasis that these definitions are useful only for case where the atmospheric pressure can be neglected or canceled and where  $\ell_0$  is zero. Thus, these limitations diminish the usefulness of pressure center definitions. In fact, the reader can find that direct calculations can sometimes simplify the problem.

#### 4.5.1.2 Multiply Layers

In the previous sections, the density was assumed to be constant. For non constant density the derivations aren't "clean" but are similar. Consider straight/flat body that is under liquid with a varying density<sup>12</sup>. If density can be represented by average density, the force that is acting on the body is

$$Geological F_{total} = \int_A g \rho h dA \sim \bar{\rho} \int_A g h dA \quad (4.130)$$

<sup>12</sup>This statement also means that density is a monotonous function. Why? Because of the buoyancy issue. It also means that the density can be a non-continuous function.



In cases where average density cannot be represented reasonably<sup>13</sup>, the integral has be carried out. In cases where density is non-continuous, but constant in segments, the following can be said

$$F_{total} = \int_A g \rho h dA = \int_{A_1} g \rho_1 h dA + \int_{A_2} g \rho_2 h dA + \cdots + \int_{A_n} g \rho_n h dA \quad (4.131)$$

As before for single density, the following can be written

$$F_{total} = g \sin \beta \left[ \rho_1 \overbrace{\int_{A_1} \xi dA}^{x_{c1} A_1} + \rho_2 \overbrace{\int_{A_2} \xi dA}^{x_{c2} A_2} + \cdots + \rho_n \overbrace{\int_{A_n} \xi dA}^{x_{cn} A_n} \right] \quad (4.132)$$

Or in a compact form and in addition considering the “atmospheric” pressure can be written as

**Total Static Force**

$$F_{total} = P_{atmos} A_{total} + g \sin \beta \sum_{i=1}^n \rho_i x_{ci} A_i \quad (4.133)$$

where the density,  $\rho_i$  is the density of the layer  $i$  and  $A_i$  and  $x_{ci}$  are geometrical properties of the area which is in contact with that layer. The atmospheric pressure can be entered into the calculation in the same way as before. Moreover, the atmospheric pressure can include all the layer(s) that do(es) not with the “contact” area.

The moment around axis  $y$ ,  $M_y$  under the same considerations as before is

$$M_y = \int_A g \rho \xi^2 \sin \beta dA \quad (4.134)$$

After similar separation of the total integral, one can find that

$$M_y = g \sin \beta \sum_{i=1}^n \rho_i I_{x'x'_i} \quad (4.135)$$

If the atmospheric pressure enters into the calculations one can find that

**Total Static Moment**

$$M_y = P_{atmos} x_c A_{total} + g \sin \beta \sum_{i=1}^n \rho_i I_{x'x'_i} \quad (4.136)$$

In the same fashion one can obtain the moment for  $x$  axis as

**Total Static Moment**

$$M_x = P_{atmos} y_c A_{total} + g \sin \beta \sum_{i=1}^n \rho_i I_{x'y'_i} \quad (4.137)$$

<sup>13</sup>A qualitative discussion on what is reasonably is not presented here. However, if the variation of the density is within 10% and/or the accuracy of the calculation is minimal, the reasonable average can be used.

To illustrate how to work with these equations the following example is provided.

**Example 4.16:**

Consider the hypothetical Figure 4.25. The last layer is made of water with density of  $1000[\text{kg}/\text{m}^3]$ . The densities are  $\rho_1 = 500[\text{kg}/\text{m}^3]$ ,  $\rho_2 = 800[\text{kg}/\text{m}^3]$ ,  $\rho_3 = 850[\text{kg}/\text{m}^3]$ , and  $\rho_4 = 1000[\text{kg}/\text{m}^3]$ . Calculate the forces at points  $a_1$  and  $b_1$ . Assume that the layers are stables without any movement between the liquids. Also neglect all mass transfer phenomena that may occur. The heights are:  $h_1 = 1[\text{m}]$ ,  $h_2 = 2[\text{m}]$ ,  $h_3 = 3[\text{m}]$ , and  $h_4 = 4[\text{m}]$ . The forces distances are  $a_1 = 1.5[\text{m}]$ ,  $a_2 = 1.75[\text{m}]$ , and  $b_1 = 4.5[\text{m}]$ . The angle of inclination is  $\beta = 45^\circ$ .

**SOLUTION**

Since there are only two unknowns, only two equations are needed, which are (4.136) and (4.133). The solution method of this example is applied for cases with less layers (for example by setting the specific height difference to be zero). Equation (4.136) can be used by modifying it, as it can be noticed that instead of using the regular atmospheric pressure the new “atmospheric” pressure can be used as

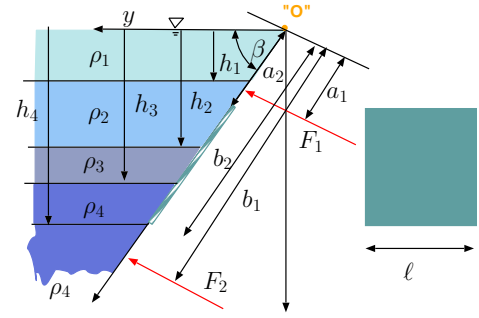

Fig. -4.25. The effects of multi layers density on static forces.

$$P_{atmos}' = P_{atmos} + \rho_1 g h_1$$

The distance for the center for each area is at the middle of each of the “small” rectangular. The geometries of each areas are

$$\begin{aligned} x_{c1} &= \frac{a_2 + \frac{h_2}{\sin \beta}}{2} & A_1 &= \ell \left( \frac{h_2}{\sin \beta} - a_2 \right) & I_{x'x'_1} &= \frac{\ell \left( \frac{h_2}{\sin \beta} - a_2 \right)^3}{36} + (x_{c1})^2 A_1 \\ x_{c2} &= \frac{h_2 + h_3}{2 \sin \beta} & A_2 &= \frac{\ell}{\sin \beta} (h_3 - h_2) & I_{x'x'_2} &= \frac{\ell (h_3 - h_2)^3}{36 \sin \beta} + (x_{c2})^2 A_2 \\ x_{c3} &= \frac{h_3 + h_4}{2 \sin \beta} & A_3 &= \frac{\ell}{\sin \beta} (h_4 - h_3) & I_{x'x'_3} &= \frac{\ell (h_4 - h_3)^3}{36 \sin \beta} + (x_{c3})^2 A_3 \end{aligned}$$

After inserting the values, the following equations are obtained

Thus, the first equation is

$$F_1 + F_2 = P_{atmos}' \overbrace{\ell (b_2 - a_2)}^{A_{total}} + g \sin \beta \sum_{i=1}^3 \rho_{i+1} x_{ci} A_i$$

The second equation is (4.136) to be written for the moment around the point “O” as

$$F_1 a_1 + F_2 b_1 = P_{atmos} \overbrace{\frac{(b_2 + a_2)}{2} \ell (b_2 - a_2)}^{x_c A_{total}} + g \sin \beta \sum_{i=1}^3 \rho_{i+1} I_{x'x'_i}$$

The solution for the above equation is

$$F_1 = \frac{2 b_1 g \sin \beta \sum_{i=1}^3 \rho_{i+1} x_{c_i} A_i - 2 g \sin \beta \sum_{i=1}^3 \rho_{i+1} I_{x'x'_i}}{2 b_1 - 2 a_1} - \frac{(b_2^2 - 2 b_1 b_2 + 2 a_2 b_1 - a_2^2) \ell P_{atmos}}{2 b_1 - 2 a_1}$$

$$F_2 = \frac{2 g \sin \beta \sum_{i=1}^3 \rho_{i+1} I_{x'x'_i} - 2 a_1 g \sin \beta \sum_{i=1}^3 \rho_{i+1} x_{c_i} A_i}{2 b_1 - 2 a_1} + \frac{(b_2^2 + 2 a_1 b_2 + a_2^2 - 2 a_1 a_2) \ell P_{atmos}}{2 b_1 - 2 a_1}$$

The solution provided isn't in the complete long form since it will makes things messy. It is simpler to compute the terms separately. A mini source code for the calculations is provided in the the text source. The intermediate results in SI units ([m], [m<sup>2</sup>], [m<sup>4</sup>]) are:

$$\begin{aligned} x_{c1} &= 2.2892 & x_{c2} &= 3.5355 & x_{c3} &= 4.9497 \\ A_1 &= 2.696 & A_2 &= 3.535 & A_3 &= 3.535 \\ I_{x'x'_1} &= 14.215 & I_{x'x'_2} &= 44.292 & I_{x'x'_3} &= 86.718 \end{aligned}$$

The final answer is

$$F_1 = 304809.79[N]$$

and

$$F_2 = 958923.92[N]$$

---

End Solution

---

### 4.5.2 Forces on Curved Surfaces

The pressure is acting on surfaces perpendicular to the direction of the surface (no shear forces assumption). At this stage, the pressure is treated as a scalar function. The element force is

$$d\mathbf{F} = -P \hat{n} d\mathbf{A} \quad (4.138)$$

Here, the conventional notation is used which is to denote the area,

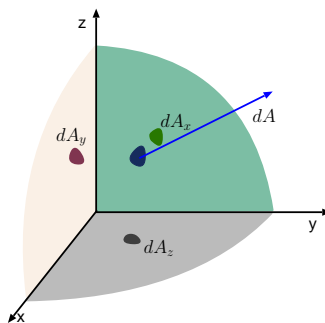

Fig. -4.26. The forces on curved area.

$dA$ , outward as positive. The total force on the area will be the integral of the unit force

$$\mathbf{F} = - \int_A P \hat{n} d\mathbf{A} \quad (4.139)$$

The result of the integral is a vector. So, if the  $y$  component of the force is needed, only a dot product is needed as

$$dF_y = d\mathbf{F} \cdot \hat{j} \quad (4.140)$$

From this analysis (equation (4.140)) it can be observed that the force in the direction of  $y$ , for example, is simply the integral of the area perpendicular to  $y$  as

$$F_y = \int_A P dA_y \quad (4.141)$$

The same can be said for the  $x$  direction.

The force in the  $z$  direction is

$$F_z = \int_A h g \rho dA_z \quad (4.142)$$

The force which acting on the  $z$  direction is the weight of the liquid above the projected area plus the atmospheric pressure. This force component can be combined with the other components in the other directions to be

$$F_{total} = \sqrt{F_z^2 + F_x^2 + F_y^2} \quad (4.143)$$

And the angle in “ $xz$ ” plane is

$$\tan \theta_{xz} = \frac{F_z}{F_x} \quad (4.144)$$

and the angle in the other plane, “ $yz$ ” is

$$\tan \theta_{zy} = \frac{F_z}{F_y} \quad (4.145)$$

The moment due to the curved surface require integration to obtain the value. There are no readily made expressions for these 3-dimensional geometries. However, for some geometries there are readily calculated center of mass and when combined with two other components provide the moment (force with direction line).

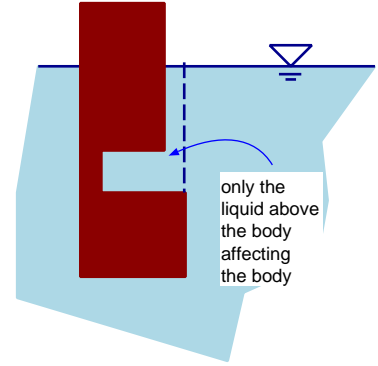

Fig. -4.27. Schematic of Net Force on floating body.

**Cut-Out Shapes Effects**

There are bodies with a shape that the vertical direction ( $z$  direction) is “cut-out” aren’t continuous. Equation (4.142) implicitly means that the net force on the body in  $z$  direction is only the actual liquid above it. For example, Figure 4.27 shows a floating body with cut-out slot into it. The atmospheric pressure acts on the area with continuous lines. Inside the slot, the atmospheric pressure with its piezometric pressure is canceled by the upper part of the slot. Thus, only the net force is the actual liquid in the slot which is acting on the body. Additional point that is worth mentioning is that the depth where the cut-out occur is insignificant (neglecting the change in the density).

Example 4.17:

Calculate the force and the moment around point “O” that is acting on the dam (see Figure (4.28)). The dam is made of an arc with the angle of  $\theta_0 = 45^\circ$  and radius of  $r = 2[m]$ . You can assume that the liquid density is constant and equal to  $1000 [kg/m^3]$ . The gravity is  $9.8[m/sec^2]$  and width of the dam is  $b = 4[m]$ . Compare the different methods of computations, direct and indirect.

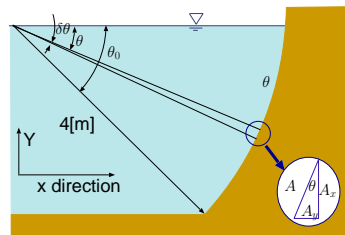

Fig. -4.28. Calculations of forces on a circular shape dam.

SOLUTION

The force in the  $x$  direction is

$$F_x = \int_A \overbrace{P r \cos \theta}^{dA_x} d\theta \tag{4.146}$$

Note that the direction of the area is taken into account (sign). The differential area that will be used is,  $b r d\theta$  where  $b$  is the width of the dam (into the page). The pressure is only a function of  $\theta$  and it is

$$P = P_{atmos} + \rho g r \sin \theta$$

The force that is acting on the  $x$  direction of the dam is  $A_x \times P$ . When the area  $A_x$  is  $b r d\theta \cos \theta$ . The atmospheric pressure does cancel itself (at least if the atmospheric pressure on both sides of the dam is the same.). The net force will be

$$F_x = \int_0^{\theta_0} \overbrace{\rho g r \sin \theta}^P \overbrace{b r \cos \theta}^{dA_x} d\theta$$

The integration results in

$$F_x = \frac{\rho g b r^2}{2} (1 - \cos^2(\theta_0))$$

Alternative way to do this calculation is by calculating the pressure at mid point and then multiply it by the projected area,  $A_x$  (see Figure 4.29) as

$$F_x = \rho g \underbrace{b r \sin \theta_0}_{A_x} \underbrace{\frac{r \sin \theta_0}{2}}_{x_c} = \frac{\rho g b r}{2} \sin^2 \theta$$

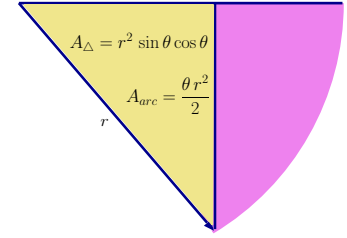

Fig. -4.29. Area above the dam arc subtract triangle.

Notice that  $dA_x(\cos \theta)$  and  $A_x(\sin \theta)$  are different, why?

The values to evaluate the last equation are provided in the question and simplify subsidize into it as

$$F_x = \frac{1000 \times 9.8 \times 4 \times 2}{2} \sin(45^\circ) = 19600.0[N]$$

Since the last two equations are identical (use the sinuous theorem to prove it  $\sin^2 \theta + \cos^2 = 1$ ), clearly the discussion earlier was right (not a good proof LOL<sup>14</sup>). The force in the  $y$  direction is the area times width.

$$F_y = - \overbrace{\left( \frac{\theta_0 r^2}{2} - \frac{r^2 \sin \theta_0 \cos \theta_0}{2} \right)}^A b g \rho \sim 22375.216[N]$$

The center area ( purple area in Figure 4.29) should be calculated as

$$y_c = \frac{y_c A_{arc} - y_c A_{triangle}}{A}$$

The center area above the dam requires to know the center area of the arc and triangle shapes. Some mathematics are required because the shift in the arc orientation. The arc center (see Figure 4.30) is at

$$y_{c_{arc}} = \frac{4 r \sin^2 \left( \frac{\theta}{2} \right)}{3 \theta}$$

<sup>14</sup>Well, it is just a demonstration!

All the other geometrical values are obtained from Tables 3.1 and 3.2. and substituting the proper values results in

$$y_{cr} = \frac{\frac{A_{arc}}{\theta r^2} \overbrace{4r \sin\left(\frac{\theta}{2}\right) \cos\left(\frac{\theta}{2}\right)}^{y_c} - \frac{\overbrace{2r \cos\theta}^{y_c} \overbrace{\sin\theta r^2}^{A_{triangle}}}{\frac{2}{A_{arc}} - \frac{2}{A_{triangle}}}}{\frac{2}{A_{arc}} - \frac{2}{A_{triangle}}}$$

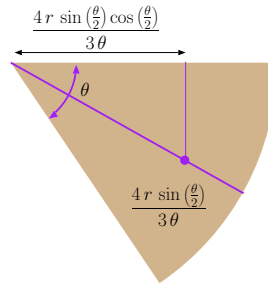

This value is the reverse value and it is

$$y_{cr} = 1.65174[m]$$

Fig. -4.30. Area above the dam arc calculation for the center.

The result of the arc center from point "O" (above calculation area) is

$$y_c = r - y_{cr} = 2 - 1.65174 \sim 0.348[m]$$

The moment is

$$M_v = y_c F_y \sim 0.348 \times 22375.2 \sim 7792.31759[N \times m]$$

The center pressure for x area is

$$x_p = x_c + \frac{I_{xx}}{x_c A} = \frac{r \cos\theta_0}{2} + \frac{\frac{I_{xx}}{36} (r \cos\theta_0)^3}{\frac{2}{x_c} (r \cos\theta_0)} = \frac{5 r \cos\theta_0}{9}$$

The moment due to hydrostatic pressure is

$$M_h = x_p F_x = \frac{5 r \cos\theta_0}{9} F_x \sim 15399.21[N \times m]$$

The total moment is the combination of the two and it is

$$M_{total} = 23191.5[N \times m]$$

For direct integration of the moment it is done as following

$$dF = P dA = \int_0^{\theta_0} \rho g \sin\theta br d\theta$$

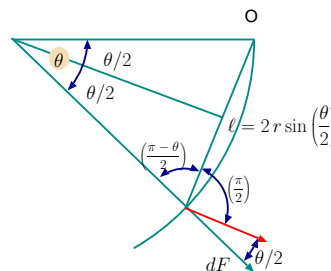

Fig. -4.31. Moment on arc element around Point "O."

and element moment is

$$dM = dF \times \overbrace{\ell}^{\ell} = dF 2r \sin\left(\frac{\theta}{2}\right) \cos\left(\frac{\theta}{2}\right)$$

and the total moment is

$$M = \int_0^{\theta_0} dM$$

or

$$M = \int_0^{\theta_0} \rho g \sin \theta b r 2r \sin\left(\frac{\theta}{2}\right) \cos\left(\frac{\theta}{2}\right) d\theta$$

The solution of the last equation is

$$M = \frac{g r \rho (2\theta_0 - \sin(2\theta_0))}{4}$$

The vertical force can be obtained by

$$F_v = \int_0^{\theta_0} P dA_v$$

or

$$F_v = \int_0^{\theta_0} \overbrace{\rho g r \sin \theta}^P \overbrace{r d\theta \cos \theta}^{dA_v}$$

$$F_v = \frac{g r^2 \rho}{2} (1 - \cos(\theta_0)^2)$$

Here, the traditional approach was presented first, and the direct approach second. It is much simpler now to use the second method. In fact, there are many programs or hand held devices that can carry numerical integration by inserting the function and the boundaries.

---

End Solution

---

To demonstrate this point further, consider a more general case of a polynomial function. The reason that a polynomial function was chosen is that almost all the continuous functions can be represented by a Taylor series, and thus, this example provides for practical purposes of the general solution for curved surfaces.

Example 4.18:



#### 4.5. FLUID FORCES ON SURFACES

For the liquid shown in Figure 4.32, calculate the moment around point "O" and the force created by the liquid per unit depth. The function of the dam shape is  $y = \sum_{i=1}^n a_i x^i$  and it is a monotonous function (this restriction can be relaxed somewhat). Also calculate the horizontal and vertical forces.

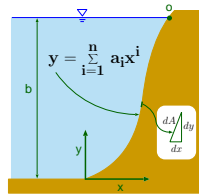

Fig. -4.32. Polynomial shape dam description for the moment around point "O" and force calculations.

#### SOLUTION

The calculations are done per unit depth (into the page) and do not require the actual depth of the dam.

The element force (see Figure 4.32) in this case is

$$dF = \overbrace{(b-y)}^P g \rho \overbrace{\sqrt{dx^2 + dy^2}}^{dA}$$

The size of the differential area is the square root of the  $dx^2$  and  $dy^2$  (see Figure 4.32). It can be noticed that the differential area that is used here should be multiplied by the depth. From mathematics, it can be shown that

$$\sqrt{dx^2 + dy^2} = dx \sqrt{1 + \left(\frac{dy}{dx}\right)^2}$$

The right side can be evaluated for any given function. For example, in this case describing the dam function is

$$\sqrt{1 + \left(\frac{dy}{dx}\right)^2} = \sqrt{1 + \left(\sum_{i=1}^n i a_i x^{i-1}\right)^2}$$

The value of  $x_b$  is where  $y = b$  and can be obtained by finding the first and positive root of the equation of

$$0 = \sum_{i=1}^n a_i x^i - b$$

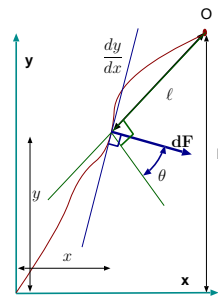

Fig. -4.33. The difference between the slope and the direction angle.

To evaluate the moment, expression of the distance and angle to point "O" are needed (see Figure 4.33). The distance between the point on the dam at  $x$  to the point "O" is

$$\ell(x) = \sqrt{(b-y)^2 + (x_b-x)^2}$$

The angle between the force and the distance to point "O" is

$$\theta(x) = \tan^{-1} \left( \frac{dy}{dx} \right) - \tan^{-1} \left( \frac{b-y}{x_b-x} \right)$$

The element moment in this case is

$$dM = \overbrace{\ell(x) (b-y) g \rho}^{dF} \sqrt{1 + \left( \frac{dy}{dx} \right)^2} \cos \theta(x) dx$$

To make this example less abstract, consider the specific case of  $y = 2x^6$ . In this case, only one term is provided and  $x_b$  can be calculated as following

$$x_b = \sqrt[6]{\frac{b}{2}}$$

Notice that  $\sqrt[6]{\frac{b}{2}}$  is measured in meters. The number "2" is a dimensional number with units of  $[1/m^5]$ . The derivative at  $x$  is

$$\frac{dy}{dx} = 12x^5$$

and the derivative is dimensionless (a dimensionless number). The distance is

$$\ell = \sqrt{(b - 2x^6)^2 + \left( \sqrt[6]{\frac{b}{2}} - x \right)^2}$$

The angle can be expressed as

$$\theta = \tan^{-1} (12x^5) - \tan^{-1} \left( \frac{b - 2x^6}{\sqrt[6]{\frac{b}{2}} - x} \right)$$

The total moment is

$$M = \int_0^{\sqrt[6]{b}} \ell(x) \cos \theta(x) (b - 2x^6) g \rho \sqrt{1 + 12x^5} dx$$

This integral doesn't have a analytical solution. However, for a given value  $b$  this integral can be evaluate. The horizontal force is

$$F_h = b \rho g \frac{b}{2} = \frac{\rho g b^2}{2}$$

The vertical force per unit depth is the volume above the dam as

$$F_v = \int_0^{\sqrt[6]{b}} (b - 2x^6) \rho g dx = \rho g \frac{5b^{\frac{7}{6}}}{7}$$

In going over these calculations, the calculations of the center of the area were not carried out. This omission saves considerable time. In fact, trying to find the center of the area will double the work. This author find this method to be simpler for complicated geometries while the indirect method has advantage for very simple geometries.

---

End Solution

---

## 4.6 Buoyancy and Stability

One of the oldest known scientific research on fluid mechanics relates to buoyancy due to question of money was carried by Archimedes. Archimedes principle is related to question of density and volume. While Archimedes did not know much about integrals, he was able to capture the essence. Here, because this material is presented in a different era, more advance mathematics will be used. While the question of the stability was not scientifically examined in the past, the floating vessels structure (more than 150 years ago) show some understanding<sup>15</sup>.

The total forces the liquid exerts on a body are considered as a buoyancy issue. To understand this issue, consider a cubical and a cylindrical body that is immersed in liquid and center in a depth of,  $h_0$  as shown in Figure 4.34. The force to hold the cylinder at the place must be made of integration of the pressure around the surface of the square and cylinder bodies. The forces on square geometry body are made only of vertical forces because the two sides cancel each other. However, on the vertical direction, the pressure on the two surfaces are different. On the upper surface the pressure is  $\rho g (h_0 - a/2)$ . On the lower surface the pressure is  $\rho g (h_0 + a/2)$ . The force due to the liquid pressure per unit depth (into the page) is

$$F = \rho g ((h_0 - a/2) - (h_0 + a/2)) \ell b = -\rho g a b \ell = -\rho g V \quad (4.147)$$

In this case the  $\ell$  represents a depth (into the page). Rearranging equation (4.147) to be

$$\frac{F}{V} = \rho g \quad (4.148)$$

The force on the immersed body is equal to the weight of the displaced liquid. This analysis can be generalized by noticing two things. All the horizontal forces are canceled. Any body that has a projected area that has two sides, those will cancel each other. Another way to look at this point is by approximation. For any two rectangle bodies, the horizontal forces are canceling each other. Thus even these bodies are in contact with each other, the imaginary pressure make it so that they cancel each other.

<sup>15</sup>This topic was the author's high school name. It was taught by people like these, 150 years ago and more, ship builders who knew how to calculate GM but weren't aware of scientific principles behind it. If the reader wonders why such a class is taught in a high school, perhaps the name can explain it: Sea Officers High School.

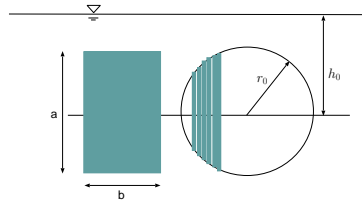

Fig. -4.34. Schematic of Immersed Cylinder.

On the other hand, any shape is made of many small rectangles. The force on every rectangular shape is made of its weight of the volume. Thus, the total force is made of the sum of all the small rectangles which is the weight of the sum of all volume.

In illustration of this concept, consider the cylindrical shape in Figure 4.34. The force per area (see Figure 4.35) is

$$dF = \overbrace{\rho g (h_0 - r \sin \theta)}^P \overbrace{\sin \theta r d\theta}^{dA_{vertical}} \quad (4.149)$$

The total force will be the integral of the equation (4.149)

$$F = \int_0^{2\pi} \rho g (h_0 - r \sin \theta) r d\theta \sin \theta \quad (4.150)$$

Rearranging equation (4.149) transforms it to

$$F = r g \rho \int_0^{2\pi} (h_0 - r \sin \theta) \sin \theta d\theta \quad (4.151)$$

The solution of equation (4.151) is

$$F = -\pi r^2 \rho g \quad (4.152)$$

The negative sign indicate that the force acting upwards. While the horizontal force is

$$F_v = \int_0^{2\pi} (h_0 - r \sin \theta) \cos \theta d\theta = 0 \quad (4.153)$$

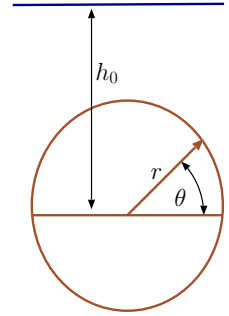

Fig. -4.35. The floating forces on Immersed Cylinder.

Example 4.19:

To what depth will a long log with radius,  $r$ , a length,  $\ell$  and density,  $\rho_w$  in liquid with density,  $\rho_l$ . Assume that  $\rho_l > \rho_w$ . You can provide that the angle or the depth.

Typical examples to explain the buoyancy are of the vessel with thin walls put upside down into liquid. The second example of the speed of the floating bodies. Since there are no better examples, these examples are a must.

Example 4.20:

A cylindrical body, shown in Figure 4.36, is floating in liquid with density,  $\rho_l$ . The body was inserted into liquid in a such a way that the air had remained in it. Express the maximum wall thickness,  $t$ , as a function of the density of the wall,  $\rho_s$  liquid density,

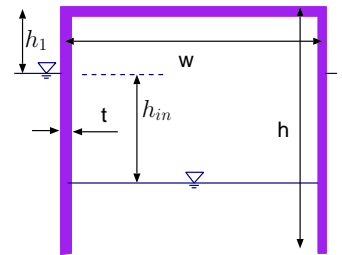

Fig. -4.36. Schematic of a thin wall floating body.

$\rho_l$  and the surroundings air temperature,  $T_1$  for the body to float. In the case where thickness is half the maximum, calculate the pressure inside the container. The container diameter is  $w$ . Assume that the wall thickness is small compared with the other dimensions ( $t \ll w$  and  $t \ll h$ ).

SOLUTION

The air mass in the container is

$$m_{air} = \underbrace{\pi w^2 h}_V \underbrace{\frac{\rho_{air} P_{atmos}}{RT}}_{\rho}$$

The mass of the container is

$$m_{container} = \left( \underbrace{\pi w^2 + 2\pi w h}_A \right) t \rho_s$$

The liquid amount enters into the cavity is such that the air pressure in the cavity equals to the pressure at the interface (in the cavity). Note that for the maximum thickness, the height,  $h_1$  has to be zero. Thus, the pressure at the interface can be written as

$$P_{in} = \rho_l g h_{in}$$

On the other hand, the pressure at the interface from the air point of view (ideal gas model) should be

$$P_{in} = \frac{m_{air} R T_1}{\underbrace{h_{in} \pi w^2}_V}$$

Since the air mass didn't change and it is known, it can be inserted into the above equation.

$$\rho_l g h_{in} + P_{atmos} = P_{in} = \frac{(\pi w^2 h) \underbrace{\frac{P_{atmos}}{RT_1}}_{\rho} R T_1}{h_{in} \pi w^2}$$

The last equation can be simplified into

$$\rho_l g h_{in} + P_{atmos} = \frac{h P_{atmos}}{h_{in}}$$

And the solution for  $h_{in}$  is

$$h_{in} = -\frac{P_{atmos} + \sqrt{4g h P_{atmos} \rho_l + P_{atmos}^2}}{2g \rho_l}$$

and

$$h_{in} = \frac{\sqrt{4g h P_{atmos} \rho_l + P_{atmos}^2} - P_{atmos}}{2g \rho_l}$$

The solution must be positive, so that the last solution is the only physical solution.

Example 4.21:

Calculate the minimum density an infinitely long equilateral triangle (three equal sides) has to be so that the sharp end is in the water.

— — — — — Advance material can be skipped — — — — —

### Extreme Cases

The solution demonstrates that when  $h \rightarrow 0$  then  $h_{in} \rightarrow 0$ . When the gravity approaches zero (macro gravity) then

$$h_{in} = \frac{P_{atmos}}{\rho_l g} + h - \frac{h^2 \rho_l g}{P_{atmos}} + \frac{2h^3 \rho_l^2 g^2}{P_{atmos}^2} - \frac{5h^4 \rho_l^3 g^3}{P_{atmos}^3} + \dots$$

This “strange” result shows that bodies don’t float in the normal sense. When the floating is under vacuum condition, the following height can be expanded into

$$h_{in} = \sqrt{\frac{h P_{atmos}}{g \rho_l}} + \frac{P_{atmos}}{2 g \rho_l} + \dots$$

which shows that the large quantity of liquid enters into the container as it is expected.

— — — — — End Advance material — — — — —

Archimedes theorem states that the force balance is at displaced weight liquid (of the same volume) should be the same as the container, the air. Thus,

$$\underbrace{\pi w^2 (h - h_{in}) g}_{\text{net displayed water}} = \underbrace{(\pi w^2 + 2 \pi w h) t \rho_s g}_{\text{container}} + \underbrace{\pi w^2 h \left( \frac{P_{atmos}}{R T_1} \right) g}_{\text{air}}$$

If air mass is neglected the maximum thickness is

$$t_{max} = \frac{2 g h w \rho_l + P_{atmos} w - w \sqrt{4 g h P_{atmos} \rho_l + P_{atmos}^2}}{(2 g w + 4 g h) \rho_l \rho_s}$$

The condition to have physical value for the maximum thickness is

$$2 g h \rho_l + P_{atmos} \geq \sqrt{4 g h P_{atmos} \rho_l + P_{atmos}^2}$$

The full solution is

$$t_{max} = \frac{(w R \sqrt{4 g h P_{atmos} \rho_l + P_{atmos}^2} - 2 g h w R \rho_l - P_{atmos} w R) T_1 + 2 g h P_{atmos} w \rho_l}{(2 g w + 4 g h) R \rho_l \rho_s T_1}$$

In this analysis the air temperature in the container immediately after insertion in the liquid has different value from the final temperature. It is reasonable as the first approximation to assume that the process is adiabatic and isentropic. Thus, the temperature in the cavity immediately after the insertion is

$$\frac{T_i}{T_f} = \left( \frac{P_i}{P_f} \right)$$

The final temperature and pressure were calculated previously. The equation of state is

$$P_i = \frac{m_{air} R T_i}{V_i}$$

The new unknown must provide additional equation which is

$$V_i = \pi w^2 h_i$$

### Thickness Below The Maximum

For the half thickness  $t = \frac{t_{max}}{2}$  the general solution for any given thickness below maximum is presented. The thickness is known, but the liquid displacement is still unknown. The pressure at the interface (after long time) is

$$\rho_l g h_{in} + P_{atmos} = \frac{\pi w^2 h \frac{P_{atmos}}{R T_1} R T_1}{(h_{in} + h_1) \pi w^2}$$

which can be simplified to

$$\rho_l g h_{in} + P_{atmos} = \frac{h P_{atmos}}{h_{in} + h_1}$$

The second equation is Archimedes' equation, which is

$$\pi w^2 (h - h_{in} - h_1) = (\pi w^2 + 2 \pi w h) t \rho_s g + \pi w^2 h \left( \frac{P_{atmos}}{R T_1} \right) g$$

---

End Solution

### Example 4.22:

*A body is pushed into the liquid to a distance,  $h_0$  and left at rest. Calculate acceleration and time for a body to reach the surface. The body's density is  $\alpha \rho_l$ , where  $\alpha$  is ratio between the body density to the liquid density and ( $0 < \alpha < 1$ ). Is the body volume important?*

### SOLUTION

The net force is

$$F = \underbrace{V g \rho_l}_{\text{liquid weight}} - \underbrace{V g \alpha \rho_l}_{\text{body weight}} = V g \rho_l (1 - \alpha)$$

But on the other side the internal force is

$$F = m a = \overbrace{V \alpha \rho_l}^m a$$

Thus, the acceleration is

$$a = g \left( \frac{1 - \alpha}{\alpha} \right)$$

If the object is left at rest (no movement) thus time will be ( $h = 1/2 a t^2$ )

$$t = \sqrt{\frac{2h\alpha}{g(1-\alpha)}}$$

If the object is very light ( $\alpha \rightarrow 0$ ) then

$$t_{min} = \sqrt{\frac{2h\alpha}{g}} + \frac{\sqrt{2gh}\alpha^{\frac{3}{2}}}{2g} + \frac{3\sqrt{2gh}\alpha^{\frac{5}{2}}}{8g} + \frac{5\sqrt{2gh}\alpha^{\frac{7}{2}}}{16g} + \dots$$

From the above equation, it can be observed that only the density ratio is important. This idea can lead to experiment in "large gravity" because the acceleration can be magnified and it is much more than the reverse of free falling.

---

End Solution

---

Example 4.23:

*In some situations, it is desired to find equivalent of force of a certain shape to be replaced by another force of a "standard" shape. Consider the force that acts on a half sphere. Find equivalent cylinder that has the same diameter that has the same force.*

SOLUTION

The force act on the half sphere can be found by integrating the forces around the sphere. The element force is

$$dF = (\rho_L - \rho_S) g \underbrace{r \cos \phi}_{h} \cos \theta \overbrace{\cos \theta \cos \phi}^{dA_x} \underbrace{r^2 d\theta d\phi}_{dA}$$

The total force is then

$$F_x = \int_0^\pi \int_0^\pi (\rho_L - \rho_S) g \cos^2 \phi \cos^2 \theta r^3 d\theta d\phi$$

The result of the integration the force on sphere is

$$F_s = \frac{\pi^2 (\rho_L - \rho_S) r^3}{4}$$

The force on equivalent cylinder is

$$F_c = \pi r^2 (\rho_L - \rho_S) h$$



These forces have to be equivalent and thus

$$\frac{\pi r^2 (\rho_L - \rho_S) r^3}{4} = \pi r^2 (\rho_L - \rho_S) h$$

Thus, the height is

$$\frac{h}{r} = \frac{\pi}{4}$$

---

End Solution

---

Example 4.24:

In the introduction to this section, it was assumed that above liquid is a gas with inconsequential density. Suppose that the above layer is another liquid which has a bit lighter density. Body with density between the two liquids,  $\rho_l < \rho_s < \rho_h$  is floating between the two liquids. Develop the relationship between the densities of liquids and solid and the location of the solid cubical. There are situations where density is a function of the depth. What will be the location of solid body if the liquid density varied parabolically.

SOLUTION

In the discussion to this section, it was shown that net force is the body volume times the the density of the liquid. In the same vein, the body can be separated into two: one in first liquid and one in the second liquid. In this case there are two different liquid densities. The net force down is the weight of the body  $\rho_c h A$ . Where  $h$  is the height of the body and  $A$  is its cross section. This force is balance according to above explanation by the two liquid as

$$\rho_c h A = A h (\alpha \rho_l + (1 - \alpha) \rho_h)$$

Where  $\alpha$  is the fraction that is in low liquid. After rearrangement it became

$$\alpha = \frac{\rho_c - \rho_h}{\rho_l - \rho_h}$$

the second part deals with the case where the density varied parabolically. The density as a function of  $x$  coordinate along  $h$  starting at point  $\rho_h$  is

$$\rho(x) = \rho_h - \left(\frac{x}{h}\right)^2 (\rho_h - \rho_l)$$

Thus the equilibration will be achieved,  $A$  is canceled on both sides, when

$$\rho_c h = \int_{x_1}^{x_1+h} \left[ \rho_h - \left(\frac{x}{h}\right)^2 (\rho_h - \rho_l) \right] dx$$

After the integration the equation transferred into

$$\rho_c h = \frac{(3 \rho_l - 3 \rho_h) x_1^2 + (3 h \rho_l - 3 h \rho_h) x_1 + h^2 \rho_l + 2 h^2 \rho_h}{3 h}$$

And the location where the lower point of the body (the physical),  $x_1$ , will be at

$$X_1 = \frac{\sqrt{3} \sqrt{3 h^2 \rho_l^2 + (4 \rho_c - 6 h^2 \rho_h) \rho_l + 3 h^2 \rho_h^2 - 12 \rho_c \rho_h + 3 h \rho_l - 3 h \rho_h}}{6 \rho_h - 2 \rho_l}$$

For linear relationship the following results can be obtained.

$$x_1 = \frac{h \rho_l + h \rho_h - 6 \rho_c}{2 \rho_l - 2 \rho_h}$$

In many cases in reality the variations occur in small zone compare to the size of the body. Thus, the calculations can be carried out under the assumption of sharp change. However, if the body is smaller compare to the zone of variation, they have to accounted for.

---

End Solution

---

Example 4.25:

A hollow sphere is made of steel ( $\rho_s/\rho_w \cong 7.8$ ) with a  $t$  wall thickness. What is the thickness if the sphere is neutrally buoyant? Assume that the radius of the sphere is  $R$ . For the thickness below this critical value, develop an equation for the depth of the sphere.

SOLUTION

The weight of displaced water has to be equal to the weight of the sphere

$$\rho_s g \frac{4 \pi R^3}{3} = \rho_w g \left( \frac{4 \pi R^3}{3} - \frac{4 \pi (R-t)^3}{3} \right) \quad (4.XXV.a)$$

after simplification equation (4.XXV.a) becomes

$$\frac{\rho_s R^3}{\rho_w} = 3 t R^2 - 3 t^2 R + t^3 \quad (4.XXV.b)$$

Equation (4.XXV.b) is third order polynomial equation which it's solution (see the appendix) is

$$\begin{aligned} t_1 &= \left( -\frac{\sqrt{3}i}{2} - \frac{1}{2} \right) \left( \frac{\rho_s R^3}{\rho_w} - R^3 \right)^{\frac{1}{3}} + R \\ t_2 &= \left( \frac{\sqrt{3}i}{2} - \frac{1}{2} \right) \left( \frac{\rho_s R^3}{\rho_w} - R^3 \right)^{\frac{1}{3}} + R \\ t_3 &= R \left( \sqrt[3]{\frac{\rho_s}{\rho_w} - 1} + 1 \right) \end{aligned} \quad (4.XXV.c)$$

The first two solutions are imaginary thus not valid for the physical world. The last solution is the solution that was needed. The depth that sphere will be located depends

on the ratio of  $t/R$  which similar analysis to the above. For a given ratio of  $t/R$ , the weight displaced by the sphere has to be same as the sphere weight. The volume of a sphere cap (segment) is given by

$$V_{cap} = \frac{\pi h^2 (3R - h)}{3} \quad (4.XXV.d)$$

Where  $h$  is the sphere height above the water. The volume in the water is

$$V_{water} = \frac{4\pi R^3}{3} - \frac{\pi h^2 (3R - h)}{3} = \frac{4\pi (R^3 - 3Rh^2 + h^3)}{3} \quad (4.XXV.e)$$

When  $V_{water}$  denotes the volume of the sphere in the water. Thus the Archimedes law is

$$\frac{\rho_w 4\pi (R^3 - 3Rh^2 + h^3)}{3} = \frac{\rho_s 4\pi (3tR^2 - 3t^2R + t^3)}{3} \quad (4.XXV.f)$$

or

$$(R^3 - 3Rh^2 + h^3) = \frac{\rho_w}{\rho_s} (3tR^2 - 3t^2R + t^3) \quad (4.XXV.g)$$

The solution of (4.XXV.g) is

$$h = \left( \frac{\sqrt{-fR(4R^3 - fR)}}{2} - \frac{fR - 2R^3}{2} \right)^{\frac{1}{3}} + \frac{R^2}{\left( \frac{\sqrt{-fR(4R^3 - fR)}}{2} - \frac{fR - 2R^3}{2} \right)^{\frac{1}{3}}} \quad (4.XXV.h)$$

Where  $-fR = R^3 - \frac{\rho_w}{\rho_s} (3tR^2 - 3t^2R + t^3)$  There are two more solutions which contains the imaginary component. These solutions are rejected.

---

End Solution

---

**Example 4.26:**

*One of the common questions in buoyancy is the weight with variable cross section and fix load. For example, a wood wedge of wood with a fix weight/load. The general question is at what the depth of the object (i.e. wedge) will be located. For simplicity, assume that the body is of a solid material.*

SOLUTION

It is assumed that the volume can be written as a function of the depth. As it was shown in the previous example, the relationship between the depth and the displaced liquid volume of the sphere. Here it is assumed that this relationship can be written as

$$V_w = f(d, \text{other geometrical parameters}) \quad (4.XXVI.a)$$

The Archimedes balance on the body is

$$\rho_\ell V_a = \rho_w V_w \quad (4.XXVI.b)$$

$$d = f^{-1} \frac{\rho_\ell V_a}{\rho_w} \quad (4.XXVI.c)$$

---

End Solution

---

**Example 4.27:**

*In example 4.26 a general solution was provided. Find the reverse function,  $f^{-1}$  for cone with  $30^\circ$  when the tip is in the bottom.*

SOLUTION

First the function has to built for  $d$  (depth).

$$V_w = \frac{\pi d \left(\frac{d}{\sqrt{3}}\right)^2}{3} = \frac{\pi d^3}{9} \quad (4.XXVII.a)$$

Thus, the depth is

$$d = \sqrt[3]{\frac{9 \pi \rho_w}{\rho_\ell V_a}} \quad (4.XXVII.b)$$

---

End Solution

---

### 4.6.1 Stability

Figure 4.37 shows a body made of hollow balloon and a heavy sphere connected by a thin and light rod. This arrangement has mass centroid close to the middle of the sphere. The buoyant center is below the middle of the balloon. If this arrangement is inserted into liquid and will be floating, the balloon will be on the top and sphere on the bottom. Tilting the body with a small angle from

its resting position creates a shift in the forces direction (examine Figure 4.37b). These forces create a moment which wants to return the body to the resting (original) position. When the body is at the position shown in Figure 4.37c, the body is unstable and any tilt from the original position creates moment that will further continue to move the body from its original position. This analysis doesn't violate the second law of thermodynamics. Moving bodies from an unstable position is in essence like a potential.

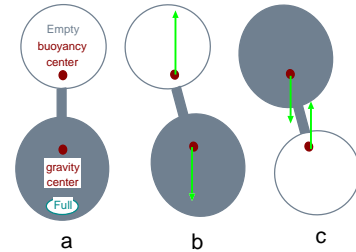

Fig. -4.37. Schematic of floating bodies.

A wooden cubic (made of pine, for example) is inserted into water. Part of the block floats above water line. The cubic mass (gravity) centroid is in the middle of the cubic. However the buoyant center is the middle of the volume under the water (see Figure 4.38). This situation is similar to Figure 4.37c. However, any experiment of this cubic wood shows that it is stable locally. Small amount of tilting of the cubic results in returning to the original position. When tilting a larger amount than  $\pi/4$ , it results in a flipping into the next stable position. The cubic is stable in six positions (every cubic has six faces). In fact, in any of these six positions, the body is in situation like in 4.37c. The reason for this local stability of the cubic is that other positions are less stable. If one draws the stability (later about this criterion) as a function of the rotation angle will show a sinusoidal function with four peaks in a whole rotation.

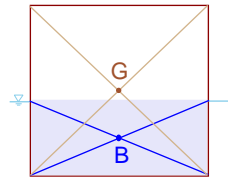

Fig. -4.38. Schematic of floating cubic.

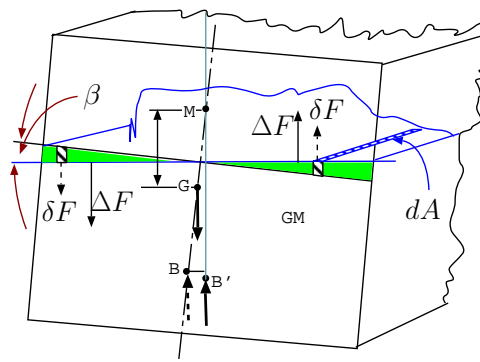

Fig. -4.39. Stability analysis of floating body.

So, the body stability must be based on the difference between the body's local positions rather than the "absolute" stability. That is, the body is "stable" in some points more than others in their vicinity. These points are raised from the buoyant force analysis. When the body is tilted at a small angle,  $\beta$ , the immersed part of the body center changes to a new location, **B'** as shown in Figure 4.39. The center of the mass (gravity) is still in the old location since the body did not change. The stability of the body is divided into three categories. If the new immerse volume creates a new center in such way that couple forces (gravity and buoyancy) try to return the body, the original state is referred as the stable body and vice versa. The third state is when the couple forces do have zero moment, it is referred to as the neutral stable.

The body, shown in Figure 4.39, when given a tilted position, move to a new buoyant center, **B'**. This deviation of the buoyant center from the old buoyant center

location,  $\mathbf{B}$ , should to be calculated. This analysis is based on the difference of the displaced liquid. The right green area (volume) in Figure 4.39 is displaced by the same area (really the volume) on left since the weight of the body didn't change<sup>16</sup> so the total immersed section is constant. For small angle,  $\beta$ , the moment is calculated as the integration of the small force shown in the Figure 4.39 as  $\Delta F$ . The displacement of the buoyant center can be calculated by examining the moment these forces creates. The body weight creates opposite moment to balance the moment of the displaced liquid volume.

$$\overline{BB'} W = \mathbf{M} \quad (4.154)$$

Where  $\mathbf{M}$  is the moment created by the displaced areas (volumes),  $\overline{BB'}$  is the distance between points  $\mathbf{B}$  and point  $\mathbf{B}'$ , and,  $W$  referred to the weight of the body. It can be noticed that the distance  $\overline{BB'}$  is an approximation for small angles (neglecting the vertical component.). So the perpendicular distance,  $\overline{BB'}$ , should be

$$\overline{BB'} = \frac{\mathbf{M}}{W} \quad (4.155)$$

The moment  $\mathbf{M}$  can be calculated as

$$\mathbf{M} = \int_A \underbrace{g \rho_l x \beta dA}_{dV} x = g \rho_l \beta \int_A x^2 dA \quad (4.156)$$

The integral in the right side of equation (4.156) is referred to as the area moment of inertia and was discussed in Chapter 3. The distance,  $\overline{BB'}$  can be written from equation (4.156) as

$$\overline{BB'} = \frac{g \rho_l I_{xx}}{\rho_s V_{body}} \quad (4.157)$$

The point where the gravity force direction is intersecting with the center line of the cross section is referred as metacentric point,  $\mathbf{M}$ . The location of the metacentric point can be obtained from the geometry as

$$\overline{BM} = \frac{\overline{BB'}}{\sin \beta} \quad (4.158)$$

And combining equations (4.157) with (4.158) yields

$$\overline{BM} = \frac{g \rho_l \beta I_{xx}}{g \rho_s \sin \beta V_{body}} = \frac{\rho_l I_{xx}}{\rho_s V_{body}} \quad (4.159)$$

For small angle ( $\beta \sim 0$ )

$$\lim_{\beta \rightarrow 0} \frac{\sin \beta}{\beta} \sim 1 \quad (4.160)$$

<sup>16</sup>It is correct to state: area only when the body is symmetrical. However, when the body is not symmetrical, the analysis is still correct because the volume and not the area is used.

It is remarkable that the results is independent of the angle. Looking at Figure 4.39, the geometrical quantities can be related as

$$\overline{GM} = \frac{\overbrace{\rho_l I_{xx}}^{\overline{BM}}}{\rho_s V_{body}} - \overline{BG} \quad (4.161)$$

Example 4.28:

A solid cone floats in a heavier liquid (that is  $\rho_l/\rho_c > 1$ ). The ratio of the cone density to liquid density is  $\alpha$ . For a very light cone  $\rho_c/\rho_l \sim 0$ , the cone has zero depth. At this condition, the cone is unstable. For middle range,  $1 > \rho_c/\rho_l > 0$  there could be a range where the cone is stable. The angle of the cone is  $\theta$ . Analyze this situation.

SOLUTION

The floating cone volume is  $\frac{\pi d r^2}{3}$  and the center of gravity is  $D/4$ . The distance  $\overline{BG}$  depend on  $d$  as

$$\overline{BG} = D/4 - d/4 \quad (4.XXVIII.a)$$

Where  $D$  is the total height and  $d$  is the height of the submerged cone. The moment of inertia of the cone is circle shown in Table 3.1. The relationship between the radius the depth is

$$r = d \tan \theta \quad (4.XXVIII.b)$$

$$\overline{GM} = \frac{\rho_l \overbrace{\frac{\pi (d \tan \theta)^4}{64}}^{I_{xx}}}{\rho_s \underbrace{\frac{\pi d (d \tan \theta)^2}{3}}_{V_{body}}} - \overbrace{\left(\frac{D}{4} - \frac{d}{4}\right)}^{\overline{BG}} \quad (4.XXVIII.c)$$

Equation (4.XXVIII.c) can be simplified as

$$\overline{GM} = \frac{\rho_l d \tan^2 \theta}{\rho_s 192} - \left(\frac{D}{4} - \frac{d}{4}\right) \quad (4.XXVIII.d)$$

The relationship between  $D$  and  $d$  is determined by the density ratio ( as displaced volume is equal to cone weight)<sup>17</sup>

$$\rho_l d^3 = \rho_c D^3 \implies D = d \sqrt[3]{\frac{\rho_l}{\rho_c}} \quad (4.XXVIII.e)$$

<sup>17</sup>Only the dimension is compared, why?

Substituting equation (4.XXVIII.e) into (4.XXVIII.d) yield the solution when  $\overline{GM} = 0$

$$0 = \frac{\rho_l d \tan^2 \theta}{\rho_s 192} - \left( \frac{d \sqrt[3]{\frac{\rho_l}{\rho_c}}}{4} - \frac{d}{4} \right) \implies \frac{\rho_l \tan^2 \theta}{\rho_s 48} = \sqrt[3]{\frac{\rho_l}{\rho_c}} - 1 \quad (4.XXVIII.f)$$

Since  $\rho_l > \rho_c$  this never happened.

End Solution

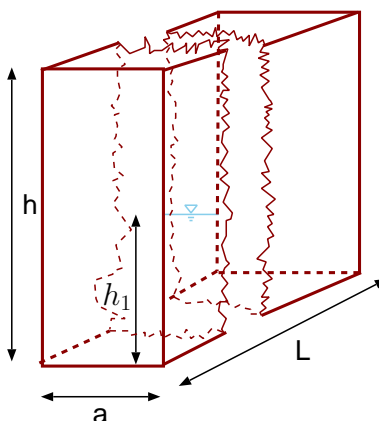

Fig. -4.40. Cubic body dimensions for stability analysis.

To understand these principles consider the following examples.

Example 4.29:

A solid block of wood of uniform density,  $\rho_s = \alpha \rho_l$  where  $(0 \leq \alpha \leq 1)$  is floating in a liquid. Construct a graph that shows the relationship of the  $\overline{GM}$  as a function of ratio height to width. Show that the block's length,  $L$ , is insignificant for this analysis.

SOLUTION

Equation (4.161) requires that several quantities should be expressed. The moment of inertia for a block is given in Table 3.1 and is  $I_{xx} = \frac{La^3}{12}$ . Where  $L$  is the length into the page. The distance  $\overline{BG}$  is obtained from Archimedes' theorem and can be expressed as

$$W = \rho_s \overbrace{a h L}^V = \rho_l \overbrace{a h_1 L}^{\text{immersed volume}} \implies h_1 = \frac{\rho_s}{\rho_l} h$$



Thus, the distance  $\overline{BG}$  is (see Figure 4.38)

$$\overline{BG} = \frac{h}{2} - \frac{\rho_s}{\rho_l} h \frac{1}{2} = \frac{h}{2} \left( 1 - \frac{\rho_s}{\rho_l} \right) \tag{4.162}$$

$$GM = \frac{g \rho_l}{g \rho_s} \frac{I_{xx}}{a h \mathcal{L}} - \frac{h}{2} \left( 1 - \frac{\rho_s}{\rho_l} \right)$$

Simplifying the above equation provides

$$\frac{\overline{GM}}{h} = \frac{1}{12 \alpha} \left( \frac{a}{h} \right)^2 - \frac{1}{2} (1 - \alpha) \tag{4.163}$$

where  $\alpha$  is the density ratio. Notice that  $\overline{GM}/h$  isn't a function of the depth,  $L$ .

This equation leads to the condition where the maximum height above which the body is not stable anymore as

$$\frac{a}{h} \geq \sqrt{6(1 - \alpha)\alpha} \tag{4.164}$$

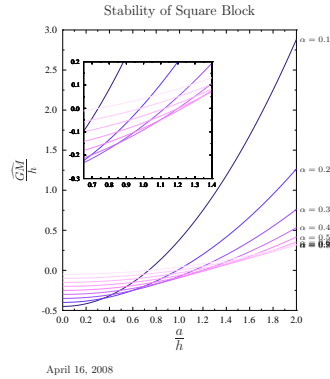

Fig. -4.41. Stability of cubic body infinity long.

End Solution

One of the interesting point for the above analysis is that there is a point above where the ratio of the height to the body width is not stable anymore. In cylindrical shape equivalent to equation (4.164) can be expressed. For cylinder (circle) the moment of inertia is  $I_{xx} = \pi b^4/64$ . The distance  $\overline{BG}$  is the same as for the square shape (cubic) (see above (4.162)). Thus, the equation is

$$\frac{\overline{GM}}{h} = \frac{g}{64 \alpha} \left( \frac{b}{h} \right)^2 - \frac{1}{2} (1 - \alpha)$$

Fig. -4.42. The maximum height reverse as a function of density ratio.

And the condition for maximum height for stability is

$$\frac{b}{h} \geq \sqrt{32(1 - \alpha)\alpha}$$

This kind of analysis can be carried for different shapes and the results are shown for these two shapes in Figure 4.42. It can be noticed that the square body is more stable than the circular body shape.

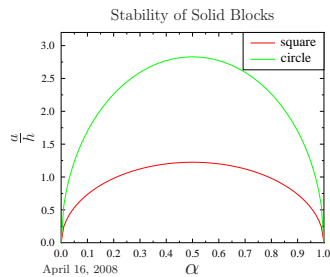

### Principle Main Axes

Any body has infinite number of different axes around which moment of inertia can be calculated. For each of these axes, there is a different moment of inertia. With the exception of the circular shape, every geometrical shape has an axis in which the moment of inertia is without the product of inertia. This axis is where the main rotation of the body will occur. Some analysis of floating bodies are done by breaking the rotation of arbitrary axis to rotate around the two main axes. For stability analysis, it is enough to find if the body is stable around the smallest moment of inertia. For example, a square shape body has larger moment of inertia around diagonal. The difference between the previous calculation and the moment of inertia around the diagonal is

$$\Delta I_{xx} = \frac{\overbrace{\sqrt{2} a \left(\frac{\sqrt{3} a}{2}\right)^3}^{I \text{ diagonal axis}}}{6} - \frac{\underbrace{a^4}_{\text{"normal" axis}}}{12} \sim 0.07 a^4$$

Which show that if the body is stable at main axes, it must be stable at the “diagonal” axis. Thus, this problem is reduced to find the stability for principle axis.

### Unstable Bodies

What happen when one increases the height ratio above the maximum height ratio? The body will flip into the side and turn to the next stable point (angle). This is not a hypothetical question, but rather practical. This happens when a ship is overloaded with containers above the maximum height. In commercial ships, the fuel is stored at the bottom of the ship and thus the mass center (point  $G$ ) is changing during the voyage. So, the ship that was stable (positive  $\overline{GM}$ ) leaving the initial port might became unstable (negative  $\overline{GM}$ ) before reaching the destination port.

Example 4.30:

One way to make a ship to be a hydrodynamic is by making the body as narrow as possible. Suppose that two opposite sides triangle (prism) is attached to each other to create a long “ship” see Figure 4.43. Supposed that  $a/h \rightarrow 0$  the body will be unstable. On the other side if the  $a/h \rightarrow \infty$  the body is very stable. What is the minimum ratio of  $a/h$  that keep the body stable at half of the volume in liquid (water). Assume that density ratio is  $\rho_l/\rho_s = \bar{\rho}$ .

#### SOLUTION

The answer to the question is that the limiting case where  $\overline{GM} = 0$ . To find this ratio equation terms in (4.161) have to be found. The Volume of the body is

$$V = 2 \left( \frac{a^2 h}{2} \right) = a^2 h$$

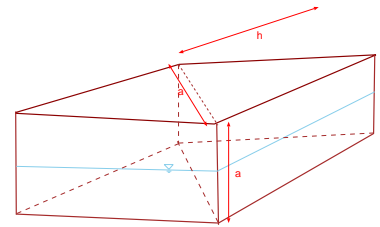

Fig. -4.43. Stability of two triangles put tougher.

The moment of inertia is triangle (see explanation in example (3.7)) is

$$I_{xx} = \frac{a h^3}{2}$$

And the volume is

$$V_{body} = a^2 \sqrt{h^2 - \frac{a^2}{4}} = a^2 h \sqrt{1 - \frac{1}{4} \frac{a^2}{h^2}}$$

The point **B** is a function of the density ratio of the solid and liquid. Denote the liquid density as  $\rho_l$  and solid density as  $\rho_s$ . The point **B** can be expressed as

$$B = \frac{a \rho_s}{2 \rho_l}$$

And thus the distance  $\overline{BG}$  is

$$\overline{BG} = \frac{a}{2} \left( 1 - \frac{\rho_s}{\rho_l} \right)$$

The limiting condition requires that  $\overline{GM} = 0$  so that

$$\frac{\rho_l I_{xx}}{\rho_s V_{body}} = \overline{BG}$$

Or explicitly

$$\frac{\rho_l \frac{a h^3}{2}}{\rho_s a^2 h \sqrt{1 - \frac{1}{4} \frac{a^2}{h^2}}} = \frac{a}{2} \left( 1 - \frac{\rho_s}{\rho_l} \right)$$

After rearrangement and using the definitions of  $\xi = h/a \bar{\rho} \rho_l / \rho_s$  results in

$$\frac{\bar{\rho} \xi^2}{\sqrt{1 - \frac{\xi^2}{4}}} = \left( 1 - \frac{1}{\bar{\rho}} \right)$$

The solution of the above solution is obtained by squaring both sides and defining a new variable such as  $x = \xi^2$ . After the above manipulation and selecting the positive value and to keep stability as

$$x < \frac{\sqrt{\frac{64 \bar{\rho}^4 - 64 \bar{\rho}^3 + \bar{\rho}^2 - 2 \bar{\rho} + 1}{\bar{\rho}} + \frac{1}{\bar{\rho}} - 1}}{2 \sqrt{2} \bar{\rho}}$$

---

End Solution

#### 4.6.1.1 Stability of Body with Shifting Mass Centroid

Ships and other floating bodies carry liquid or have a load which changes the mass location during tilting of the floating body. For example, a ship that carries wheat grains where the cargo is not properly secured to the ship. The movement of the load (grains, furniture, and/or liquid) does not occur in the same speed as the body itself or the displaced outside liquid. Sometimes, the slow reaction of the load, for stability analysis, is enough to be ignored. Exact analysis requires taking into account these shifting mass speeds. However, here, the extreme case where the load reacts in the same speed as the tilting of the ship/floating body is examined. For practical purposes, it is used as a limit for the stability analysis. There are situations where the real case approaches to this extreme. These situations involve liquid with a low viscosity (like water, alcohol) and ship with low natural frequency (later on the frequency of the ships). Moreover, in this analysis, the dynamics are ignored and only the statics is examined (see Figure 4.44).

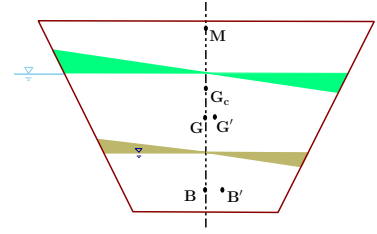

Fig. -4.44. The effects of liquid movement on the  $\overline{GM}$ .

A body is loaded with liquid "B" and is floating in a liquid "A" as shown in Figure 4.44. When the body is given a tilting position the body displaces the liquid on the outside. At the same time, the liquid inside is changing its mass centroid. The moment created by the inside displaced liquid is

$$M_{in} = g \rho_{lB} \beta I_{xxB} \tag{4.165}$$

Note that  $I_{xxB}$  isn't the same as the moment of inertia of the outside liquid interface. The change in the mass centroid of the liquid "A" then is

$$\overline{G_1 G'_1} = \frac{\int \rho_B \beta I_{xxB}}{\int V_B \rho_B} = \frac{I_{xxB}}{V_B} \tag{4.166}$$

Inside liquid weight

Equation (4.166) shows that  $\overline{GG'}$  is only a function of the geometry. This quantity,  $\overline{G_1 G'_1}$ , is similar for all liquid tanks on the floating body.

The total change of the vessel is then calculated similarly to center area calculations.

$$\int m_{total} \overline{GG'} = \int m_{body} \overline{GG'} + \int m_f \overline{G_1 G'_1} \tag{4.167}$$

For more than one tank, it can be written as

$$\overline{GG'} = \frac{g}{W_{total}} \sum_{i=1}^n \overline{G_i G'_i} \rho_{l_i} V_i = \frac{g}{W_{total}} \sum_{i=1}^n \frac{I_{xx b_i}}{V_{b_i}} \tag{4.168}$$

A new point can be defined as  $G_c$ . This point is the intersection of the center line with the vertical line from  $G'$ .

$$\overline{GG_c} = \frac{\overline{GG'}}{\sin \beta} \tag{4.169}$$

The distance that was used before  $\overline{GM}$  is replaced by the criterion for stability by  $\overline{G_c M}$  and is expressed as

$$\overline{G_c M} = \frac{g \rho_A I_{xxA}}{\rho_s V_{body}} - \overline{BG} - \frac{1}{m_{total}} \frac{I_{xxb}}{V_b} \tag{4.170}$$

If there are more than one tank partially filled with liquid, the general formula is

$$\overline{G_c M} = \frac{g \rho_A I_{xxA}}{\rho_s V_{body}} - \overline{BG} - \frac{1}{m_{total}} \sum_{i=1}^n \frac{I_{xxbi}}{V_{bi}} \tag{4.171}$$

One way to reduce the effect of the moving mass center due to liquid is done by substituting a single tank with several tanks. The moment of inertial of the combine two tanks is smaller than the moment of inertial of a single tank. Increasing the number of tanks reduces the moment of inertia. The engineer could design the tanks in such a way that the moment of inertia is operationally changed. This control of the stability,  $\overline{GM}$ , can be achieved by having some tanks spanning across the entire body with tanks spanning on parts of the body. Movement of the liquid (mostly the fuel and water) provides way to control the stability,  $GM$ , of the ship.

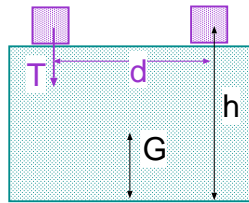

Fig. -4.45. Measurement of  $GM$  of floating body.

**4.6.1.2 Metacentric Height,  $\overline{GM}$ , Measurement**

The metacentric height can be measured by finding the change in the angle when a weight is moved on the floating body.

Moving the weight,  $T$  a distance,  $d$  then the moment created is

$$M_{weight} = T d \tag{4.172}$$

This moment is balanced by

$$M_{righting} = W_{total} \overline{GM}_{new} \theta \tag{4.173}$$

Where,  $W_{total}$ , is the total weight of the floating body including measuring weight. The angle,  $\theta$ , is measured as the difference in the orientation of the floating body. The

metacentric height is

$$\overline{GM}_{new} = \frac{T d}{W_{total} \theta} \quad (4.174)$$

If the change in the  $\overline{GM}$  can be neglected, equation (4.174) provides the solution. The calculation of  $\overline{GM}$  can be improved by taking into account the effect of the measuring weight. The change in height of  $G$  is

$$\oint m_{total} G_{new} = \oint m_{ship} G_{actual} + \oint T h \quad (4.175)$$

Combining equation (4.175) with equation (4.174) results in

$$\overline{GM}_{actual} = \overline{GM}_{new} \frac{m_{total}}{m_{ship}} - h \frac{T}{m_{ship}} \quad (4.176)$$

The weight of the ship is obtained from looking at the ship depth.

#### 4.6.1.3 Stability of Submerged Bodies

The analysis of submerged bodies is different from the stability when the body lays between two fluid layers with different density. When the body is submerged in a single fluid layer, then none of the changes of buoyant centroid occurs. Thus, the mass centroid must be below than buoyant centroid in order to have stable condition.

However, all fluids have density varied in some degree. In cases where the density changes significantly, it must be taken into account. For an example of such a case is an object floating in a solar pond where the upper layer is made of water with lower salinity than the bottom layer (change up to 20% of the density). When the floating object is immersed into two layers, the stability analysis must take into account the changes of the displaced liquids of the two liquid layers. The calculations for such cases are a bit more complicated but based on the similar principles. Generally, this density change helps to increase the stability of the floating bodies. This analysis is out of the scope of this book (for now).

#### 4.6.1.4 Stability of None Systematical or “Strange” Bodies

While most floating bodies are symmetrical or semi-symmetrical, there are situations where the body has a “strange” and/or un-symmetrical body. Consider the first strange body that has an abrupt step change as shown in Figure 4.46. The body weight doesn't change during the rotation that the green area on the left and the green area on right are the same (see Figure 4.46). There are two situations that can occur. After the tilting, the upper part

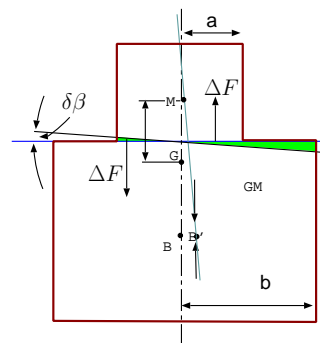

Fig. -4.46. Calculations of  $\overline{GM}$  for abrupt shape body.

of the body is above the liquid or part of the body is submerged under the water.

The mathematical condition for the border is when  $b = 3a$ . For the case of  $b < 3a$

the calculation of moment of inertia are similar to the previous case. The moment created by change in the displaced liquid (area) act in the same fashion as the before. The center of the moment is needed to be found. This point is the intersection of the liquid line with the brown middle line. The moment of inertia should be calculated around this axis.

For the case where  $b < 3a$  some part is under the liquid. The amount of area under the liquid section depends on the tilting angle. These calculations are done as if none of the body under the liquid. This point is intersection point liquid with lower body and it is needed to be calculated. The moment of inertia is calculated around this point (note the body is "ended" at end of the upper body). However, the moment to return the body is larger than actually was calculated and the bodies tend to be more stable (also for other reasons).

#### 4.6.1.5 Neutral frequency of Floating Bodies

This case is similar to pendulum (or mass attached to spring). The governing equation for the pendulum is

$$\ell \ddot{\beta} - g \beta = 0 \quad (4.177)$$

Where here  $\ell$  is length of the rode (or the line/wire) connecting the mass with the rotation point. Thus, the frequency of pendulum is  $\frac{1}{2\pi} \sqrt{\frac{g}{\ell}}$  which measured in  $Hz$ . The period of the cycle is  $2\pi \sqrt{\ell/g}$ . Similar situation exists in the case of floating bodies. The basic differential equation is used to balance and is

$$\overbrace{I \ddot{\beta}}^{\text{rotation}} - \overbrace{V \rho_s \overline{GM} \beta}^{\text{rotating moment}} = 0 \quad (4.178)$$

In the same fashion the frequency of the floating body is

$$\frac{1}{2\pi} \sqrt{\frac{V \rho_s \overline{GM}}{I_{body}}} \quad (4.179)$$

and the period time is

$$2\pi \sqrt{\frac{I_{body}}{V \rho_s \overline{GM}}} \quad (4.180)$$

In general, the larger  $\overline{GM}$  the more stable the floating body is. Increase in  $\overline{GM}$  increases the frequency of the floating body. If the floating body is used to transport humans and/or other creatures or sensitive cargo it requires to reduce the  $\overline{GM}$  so that the traveling will be smoother.

### 4.6.2 Surface Tension

The surface tension is one of the mathematically complex topic and related to many phenomena like boiling, coating, etc. In this section, only simplified topics like constant value will be discussed.

In one of the early studies of the surface tension/pressure was done by Torricelli<sup>18</sup>. In this study he suggest construction of the early barometer. In barometer is made from a tube sealed on one side. The tube is filled with a liquid and turned upside down into the liquid container. The main effect is the pressure difference between the two surfaces (in the tube and out side the tune). However, the surface tension affects the high. This effect is large for very small diameters.

Example 4.31:

*In interaction of the molecules shown in Figure ? describe the existence of surface tension. Explain why this description is erroneous?*

SOLUTION

The upper layer of the molecules have unbalanced force towards the liquid phase. Newton's law states when there is unbalanced force, the body should be accelerate. However, in this case, the liquid is not in motion. Thus, the common explanation is wrong.

---

End Solution

---



Fig. -4.47. A heavy needle is floating on a liquid.

Example 4.32:

*Needle is made of steel and is heavier than water and many other liquids. However, the surface tension between the needle and the liquid hold the needle above the liquid. After certain diameter, the needle cannot be held by the liquid. Calculate the maximum diameter needle that can be inserted into liquid without drowning.*

SOLUTION

Under Construction

---

End Solution

---

<sup>18</sup>Evangelista Torricelli October 15, 1608 – October 25, 1647 was an Italian physicist best known for his invention of the barometer.



## 4.7 Rayleigh–Taylor Instability

Rayleigh–Taylor instability (or RT instability) is named after Lord Rayleigh and G. I. Taylor. There are situations where a heavy liquid layer is placed over a lighter fluid layer. This situation has engineering implications in several industries. For example in die casting, liquid metal is injected in a cavity filled with air. In poor designs or other situations, some air is not evacuated and stay in small cavity on the edges of the shape to be casted. Thus, it can create a situation where the liquid metal is above the air but cannot penetrate into the cavity because of instability.

This instability deals with a dense, heavy fluid that is being placed above a lighter fluid in a gravity field perpendicular to interface. Example for such systems are dense water over oil (liquid–liquid), or water over air (gas–liquid). The original Rayleigh’s paper deals with the dynamics and density variations. For example, density variations according to the bulk modulus (see section 4.3.3.2) are always stable but unstable of the density is in the reversed order.

Supposed that a liquid density is arbitrary function of the height. This distortion can be as a result of heavy fluid above the lighter liquid. This analysis asks the question of what happen when a small amount of liquid from the above layer enter into the lower layer? Whether this liquid continue and will grow or will it return to its original conditions? The surface tension is the opposite mechanism that will returns the liquid to its original place. This analysis is referred to the case of infinite or very large surface. The simplified case is the two different uniform densities. For example a heavy fluid density,  $\rho_L$ , above lower fluid with lower density,  $\rho_G$ .

For perfectly straight interface, the heavy fluid will stay above the lighter fluid. If the surface will be disturbed, some of heavy liquid moves down. This disturbance can grow or returned to its original situation. This condition is determined by competing forces, the surface density, and the buoyancy forces. The fluid above the depression is in equilibrium with the sounding pressure since the material is extending to infinity. Thus, the force that acting to get the above fluid down is the buoyancy force of the fluid in the depression.

The depression is returned to its original position if the surface forces are large enough. In that case, this situation is considered to be stable. On the other hand, if the surface forces (surface tension) are not sufficient, the situation is unstable and the heavy liquid enters into the liquid fluid zone and vice versa. As usual there is the neutral stable when the forces are equal. Any continues function can be expanded in series of cosines. Thus, example of a cosine function will be examined. The conditions that required from this function will be required from all the other functions. The disturbance is of the following

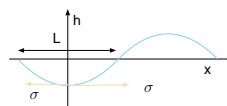

Fig. -4.48. Description of depression to explain the Rayleigh–Taylor instability.

$$h = -h_{max} \cos \frac{2\pi x}{L} \quad (4.181)$$

where  $h_{max}$  is the maximum depression and  $L$  is the characteristic length of the depression. The depression has different radius as a function of distance from the center of the depression,  $x$ . The weakest point is at  $x = 0$  because symmetrical reasons the surface tension does not act against the gravity as shown in Figure (4.48). Thus, if the center point of the depression can “hold” the intrusive fluid then the whole system is stable.

The radius of any equation is expressed by equation (1.57). The first derivative of  $\cos$  around zero is  $\sin$  which is approaching zero or equal to zero. Thus, equation (1.57) can be approximated as

$$\frac{1}{R} = \frac{d^2 h}{dx^2} \quad (4.182)$$

For equation (4.181) the radius is

$$\frac{1}{R} = -\frac{4\pi^2 h_{max}}{L^2} \quad (4.183)$$

According to equation (1.46) the pressure difference or the pressure jump is due to the surface tension at this point must be

$$P_H - P_L = \frac{4 h_{max} \sigma \pi^2}{L^2} \quad (4.184)$$

The pressure difference due to the gravity at the edge of the disturbance is then

$$P_H - P_L = g (\rho_H - \rho_L) h_{max} \quad (4.185)$$

Comparing equations (4.184) and (4.185) show that if the relationship is

$$\frac{4\sigma\pi^2}{L^2} > g (\rho_H - \rho_L) \quad (4.186)$$

It should be noted that  $h_{max}$  is irrelevant for this analysis as it is canceled. The point where the situation is neutral stable

$$L_c = \sqrt{\frac{4\pi^2\sigma}{g(\rho_H - \rho_L)}} \quad (4.187)$$

An alternative approach to analyze this instability is suggested here. Consider the situation described in Figure 4.49. If all the heavy liquid “attempts” to move straight down, the lighter liquid will “prevent” it. The lighter liquid needs to move up at the same time but in a different place. The heavier liquid needs to move in one side and the lighter liquid in another location. In this process the heavier liquid “enter” the lighter liquid in one point and creates a depression as shown in Figure 4.49.

To analyze it, considered two control volumes bounded by the blue lines in Figure 4.49. The first control volume is made of a cylinder with a radius  $r$  and the second is the depression below it. The “extra” lines of the depression should be ignored, they are not part of the control volume. The horizontal forces around the control volume are canceling each other. At the top, the force is atmospheric pressure times the area. At the cylinder bottom, the force is  $\rho g h \times A$ . This acts against the gravity force which make the cylinder to be in equilibrium with its surroundings if the pressure at bottom is indeed  $\rho g h$ .

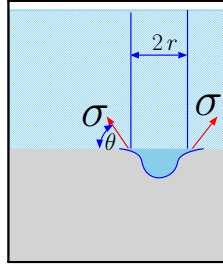

Fig. -4.49. Description of depression to explain the instability.

For the depression, the force at the top is the same force at the bottom of the cylinder. At the bottom, the force is the integral around the depression. It can be approximated as a flat cylinder that has depth of  $r \pi/4$  (read the explanation in the example 4.23) This value is exact if the shape is a perfect half sphere. In reality, the error is not significant. Additionally when the depression occurs, the liquid level is reduced a bit and the lighter liquid is filling the missing portion. Thus, the force at the bottom is

$$F_{bottom} \sim \pi r^2 \left[ \left( \frac{\pi r}{4} + h \right) (\rho_L - \rho_G) g + P_{atmos} \right] \quad (4.188)$$

The net force is then

$$F_{bottom} \sim \pi r^2 \left( \frac{\pi r}{4} \right) (\rho_L - \rho_G) g \quad (4.189)$$

The force that hold this column is the surface tension. As shown in Figure 4.49, the total force is then

$$F_{\sigma} = 2 \pi r \sigma \cos \theta \quad (4.190)$$

The forces balance on the depression is then

$$2 \pi r \sigma \cos \theta \sim \pi r^2 \left( \frac{\pi r}{4} \right) (\rho_L - \rho_G) g \quad (4.191)$$

The radius is obtained by

$$r \sim \sqrt{\frac{2 \pi \sigma \cos \theta}{(\rho_L - \rho_G) g}} \quad (4.192)$$

The maximum surface tension is when the angle,  $\theta = \pi/2$ . At that case, the radius is

$$r \sim \sqrt{\frac{2 \pi \sigma}{(\rho_L - \rho_G) g}} \quad (4.193)$$

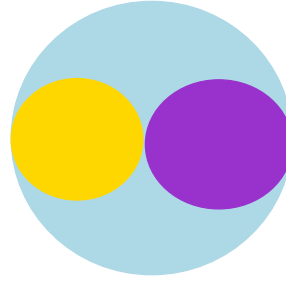

Fig. -4.50. The cross section of the interface. The purple color represents the maximum heavy liquid raising area. The yellow color represents the maximum lighter liquid that are “going down.”

The maximum possible radius of the depression depends on the geometry of the container. For the cylindrical geometry, the maximum depression radius is about half for the container radius (see Figure 4.50). This radius is limited because the lighter liquid has to enter at the same time into the heavier liquid zone. Since the “exchange” volumes of these two process are the same, the specific radius is limited. Thus, it can be written that the minimum radius is

$$r_{mintube} = 2 \sqrt{\frac{2 \pi \sigma}{g (\rho_L - \rho_G)}} \quad (4.194)$$

The actual radius will be much larger. The heavier liquid can stay on top of the lighter liquid without being turned upside down when the radius is smaller than the equation 4.194. This analysis introduces a new dimensional number that will be discussed in a greater length in the Dimensionless chapter. In equation (4.194) the angle was assumed to be 90 degrees. However, this angle is never can be obtained. The actual value of this angle is about  $\pi/4$  to  $\pi/3$  and in only extreme cases the angle exceed this value (considering dynamics). In Figure 4.50, it was shown that the depression and the raised area are the same. The actual area of the depression is only a fraction of the interfacial cross section and is a function. For example, the depression is larger for square area. These two scenarios should be inserting into equation 4.168 by introducing experimental coefficient.

Example 4.33:

*Estimate the minimum radius to insert liquid aluminum into represent tube at temperature of  $600[K]$ . Assume that the surface tension is  $400[mN/m]$ . The density of the aluminum is  $2400kg/m^3$ .*

SOLUTION

The depression radius is assume to be significantly smaller and thus equation (4.193)

can be used. The density of air is negligible as can be seen from the temperature compare to the aluminum density.

$$r \sim \sqrt{\frac{8\pi \overbrace{0.4}^{\sigma}}{2400 \times 9.81}}$$

The minimum radius is  $r \sim 0.02[m]$  which demonstrates the assumption of  $h \gg r$  was appropriate.

---

End Solution

---

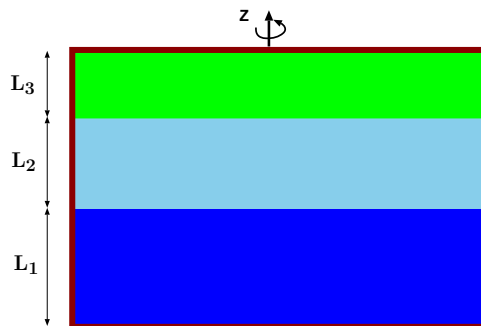

Fig. -4.51. Three liquids layers under rotation with various critical situations.

### Open Question by April 15, 2010

The best solution of the following question will win 18 U.S. dollars and your name will be associated with the solution in this book.

Example 4.34:

A canister shown in Figure 4.51 has three layers of different fluids with different densities. Assume that the fluids do not mix. The canister is rotate with circular velocity,  $\omega$ . Describe the interface of the fluids consider all the limiting cases. Is there any difference if the fluids are compressible? Where is the maximum pressure points? For the case that the fluids are compressible, the canister top center is connected to another tank with equal pressure to the canister before the rotation (the connection point). What happen after the canister start to be rotated? Calculated the volume that will enter or leave, for known geometries of the fluids. Use the ideal gas model. You can assume that the process is isothermal. Is there any difference if the process is isentropic? If so, what is the difference?

## 4.8 Qualitative questions

These qualitative questions are for advance students and for those who would like to prepare themselves preliminary examination (Ph. D. examinations).

1. The atmosphere has different thickness in different locations. Where will be atmosphere thickness larger in the equator or the north pole? Explain your reasoning for the difference. How would you estimate the difference between the two locations.
2. The author's daughter (8 years old) that fluid mechanics make no sense. For example, she points out that warm air raise and therefor the warm spot in a house is the top floor (that is correct in 4 story home). So why when there is snow on high mountains? It must be that the temperature is below freezing point on the top of the mountain (see for example Mount Kilimanjaro, Kenya). How would you explain this situation? Hint, you should explain this phenomenon using only concepts that were developed in this chapter.
3. The surface of the ocean has spherical shape. The stability analysis that was discussed in this chapter was based on the assumption that surface is straight. How in your opinion the effect of the surface curvature affects the stability analysis.
4. If the gravity was change due the surface curvature what is the effect on the stability.
5. A car is accelerated (increase of velocity) in an include surface upwards. Draw the constant pressure line. What will constant pressure lines if the car will be driven downwards.
6. A symmetrical cylinder filled with liquid is rotating around its center. What are the directions of the forces that acting on cylinder. What are the direction of the force if the cylinder is not symmetrical?
7. A body with a constant area is floating in the liquid. The body is pushed down of the equilibrium state into the liquid by a distance  $\ell$ . Assume that the body is not totally immersed in the liquid. What are simple harmonic frequency of the body. Assume the body mass is  $m$  its volume is,  $V$ . Additionally assume that the only body motion is purely vertical and neglect the add mass and liquid resistance.

**Part I**

**Integral Analysis**





---

---

# CHAPTER 5

---

## The Control Volume and Mass Conservation

### 5.1 Introduction

This chapter presents a discussion on the control volume and will be focused on the conservation of the mass. When the fluid system moves or changes, one wants to find or predict the velocities in the system. The main target of such analysis is to find the value of certain variables. This kind of analysis is reasonable and it referred to in the literature as the Lagrangian Analysis. This name is in honored J. L. Langrange (1736–1813) who formulated the equations of motion for the moving fluid particles.

Even though this system looks reasonable, the Lagrangian system turned out to be difficult to solve and to analyze. This method applied and used in very few cases. The main difficulty lies in the fact that every particle has to be traced to its original state. Leonard Euler (1707–1783) suggested an alternative approach. In Euler's approach the focus is on a defined point or a defined volume. This methods is referred as Eulerian method.

The Eulerian method focuses on a defined area or location to find the needed information. The use of the Eulerian methods leads to a set differentiation equations that is referred to as Navier–Stokes equations which are commonly used. These differential equations will be used in the later part of this book. Ad-

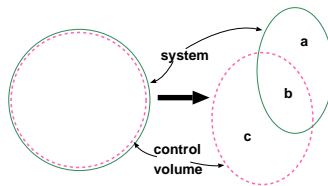

*Fig. -5.1. Control volume and system before and after motion.*

ditionally, the Eulerian system leads to integral equations which are the focus of this part of the book. The Eulerian method plays well with the physical intuition of most people. This method has its limitations and for some cases the Lagrangian is preferred (and sometimes the only possibility). Therefore a limited discussion on the Lagrangian system will be presented (later version).

Lagrangian equations are associated with the system while the Eulerian equation are associated with the control volume. The difference between the system and the control volume is shown in Figure 5.1. The green lines in Figure 5.1 represent the system. The red dotted lines are the control volume. At certain time the system and the control volume are identical location. After a certain time, some of the mass in the system exited the control volume which are marked "a" in Figure 5.1. The material that remained in the control volume is marked as "b". At the same time, the control volume gains some material which is marked as "c".

## 5.2 Control Volume

The Eulerian method requires to define a control volume (some time more than one). The control volume is a defined volume that was discussed earlier. The control volume is differentiated into two categories of control volumes, non-deformable and deformable.

**Non-deformable control volume** is a control volume which is fixed in space relatively to an one coordinate system. This coordinate system may be in a relative motion to another (almost absolute) coordinate system.

**Deformable control volume** is a volume having part of all of its boundaries in motion during the process at hand.

In the case where no mass crosses the boundaries, the control volume is a system. Every control volume is the focus of the certain interest and will be dealt with the basic equations, mass, momentum, energy, entropy etc.

Two examples of control volume are presented to illustrate difference between a deformable control volume and non-deformable control volume. Flow in conduits can be analyzed by looking in a control volume between two locations. The coordinate system could be fixed to the conduit. The control volume chosen is non-deformable control volume. The control volume should be chosen so that the analysis should be simple and dealt with as less as possible issues which are not in question. When a piston pushing gases a good choice of control volume is a deformable control volume that is a head the piston inside the cylinder as shown in Figure 5.2.

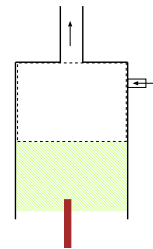

Fig. -5.2. Control volume of a moving piston with in and out flow.

### 5.3 Continuity Equation

In this chapter and the next three chapters, the conservation equations will be applied to the control volume. In this chapter, the mass conservation will be discussed. The system mass change is

$$\frac{D m_{sys}}{Dt} = \frac{D}{Dt} \int_{V_{sys}} \rho dV = 0 \quad (5.1)$$

The system mass after some time, according Figure 5.1, is made of

$$m_{sys} = m_{c.v.} + m_a - m_c \quad (5.2)$$

The change of the system mass is by definition is zero. The change with time (time derivative of equation (5.2)) results in

$$0 = \frac{D m_{sys}}{Dt} = \frac{d m_{c.v.}}{dt} + \frac{d m_a}{dt} - \frac{d m_c}{dt} \quad (5.3)$$

The first term in equation (5.3) is the derivative of the mass in the control volume and at any given time is

$$\frac{d m_{c.v.}(t)}{dt} = \frac{d}{dt} \int_{V_{c.v.}} \rho dV \quad (5.4)$$

and is a function of the time.

The interface of the control volume can move. The actual velocity of the fluid leaving the control volume is the relative velocity (see Figure 5.3). The relative velocity is

$$\vec{U}_r = \vec{U}_f - \vec{U}_b \quad (5.5)$$

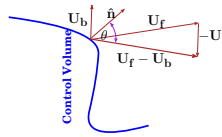

Fig. -5.3. Schematics of velocities at the interface.

Where  $U_f$  is the liquid velocity and  $U_b$  is the boundary velocity (see Figure 5.3). The velocity component that is perpendicular to the surface is

$$U_{rn} = -\hat{n} \cdot \vec{U}_r = U_r \cos \theta \quad (5.6)$$

Where  $\hat{n}$  is a unit vector perpendicular to the surface. The convention of direction is taken positive if flow out the control volume and negative if the flow is into the control volume. The mass flow out of the control volume is the system mass that is not included in the control volume. Thus, the flow out is

$$\frac{d m_a}{dt} = \int_{S_{cv}} \rho_s U_{rn} dA \quad (5.7)$$

It has to be emphasized that the density is taken at the surface thus the subscript  $s$ . In the same manner, the flow rate in is

$$\frac{dm_b}{dt} = \int_{S_{c.v.}} \rho_s U_{rn} dA \quad (5.8)$$

It can be noticed that the two equations (5.8) and (5.7) are similar and can be combined, taking the positive or negative value of  $U_{rn}$  with integration of the entire system as

$$\frac{dm_a}{dt} - \frac{dm_b}{dt} = \int_{S_{c.v.}} \rho_s U_{rn} dA \quad (5.9)$$

applying negative value to keep the convention. Substituting equation (5.9) into equation (5.3) results in

Continuity

$$\frac{d}{dt} \int_{c.v.} \rho_s dV = - \int_{S_{c.v.}} \rho U_{rn} dA \quad (5.10)$$

Equation (5.10) is essentially accounting of the mass. Again notice the negative sign in surface integral. The negative sign is because flow out marked positive which reduces of the mass (negative derivative) in the control volume. The change of mass change inside the control volume is net flow in or out of the control system.

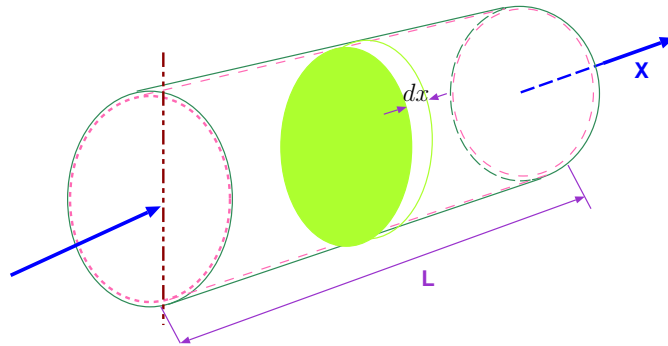

Fig. -5.4. Schematics of flow in pipe with varying density as a function time for example 5.1.

The next example is provided to illustrate this concept.

Example 5.1:

The density changes in a pipe, due to temperature variation and other reasons, can be approximated as

$$\frac{\rho(x, t)}{\rho_0} = \left(1 - \frac{x}{L}\right)^2 \cos \frac{t}{t_0}.$$

The conduit shown in Figure 5.4 length is  $L$  and its area is  $A$ . Express the mass flow in and/or out, and the mass in the conduit as function of time. Write the expression for the mass change in the pipe.

#### SOLUTION

Here it is very convenient to choose a non-deformable control volume that is inside the conduit  $dV$  is chosen as  $\pi R^2 dx$ . Using equation (5.10), the flow out (or in) is

$$\frac{d}{dt} \int_{c.v.} \rho dV = \frac{d}{dt} \int_{c.v.} \overbrace{\rho_0 \left(1 - \frac{x}{L}\right)^2 \cos\left(\frac{t}{t_0}\right)}^{\rho(t)} \overbrace{\pi R^2 dx}^{dV}$$

The density is not a function of radius,  $r$  and angle,  $\theta$  and they can be taken out the integral as

$$\frac{d}{dt} \int_{c.v.} \rho dV = \pi R^2 \frac{d}{dt} \int_{c.v.} \rho_0 \left(1 - \frac{x}{L}\right)^2 \cos\left(\frac{t}{t_0}\right) dx$$

which results in

$$\text{Flow Out} = \overbrace{\pi R^2}^A \frac{d}{dt} \int_0^L \rho_0 \left(1 - \frac{x}{L}\right)^2 \cos\frac{t}{t_0} dx = -\frac{\pi R^2 L \rho_0}{3 t_0} \sin\left(\frac{t}{t_0}\right)$$

The flow out is a function of length,  $L$ , and time,  $t$ , and is the change of the mass in the control volume.

---

End Solution

---

### 5.3.1 Non Deformable Control Volume

When the control volume is fixed with time, the derivative in equation (5.10) can enter the integral since the boundaries are fixed in time and hence,

Continuity with Fixed b.c.

$$\int_{V_{c.v.}} \frac{d\rho}{dt} dV = - \int_{S_{c.v.}} \rho U_{rn} dA \quad (5.11)$$

Equation (5.11) is simpler than equation (5.10).

### 5.3.2 Constant Density Fluids

Further simplifications of equations (5.10) can be obtained by assuming constant density and the equation (5.10) become conservation of the volume.

### 5.3.2.1 Non Deformable Control Volume

For this case the volume is constant therefore the mass is constant, and hence the mass change of the control volume is zero. Hence, the net flow (in and out) is zero. This condition can be written mathematically as

$$\overbrace{\frac{d}{dt} \int_{S_{c.v.}} V_{rn} dA}^{=0} \rightarrow \int_{S_{c.v.}} V_{rn} dA = 0 \quad (5.12)$$

or in a more explicit form as

**Steady State Continuity**

$$\int_{S_{in}} V_{rn} dA = \int_{S_{out}} V_{rn} dA = 0 \quad (5.13)$$

Notice that the density does not play a role in this equation since it is canceled out. Physically, the meaning is that volume flow rate in and the volume flow rate out have to equal.

### 5.3.2.2 Deformable Control Volume

The left hand side of question (5.10) can be examined further to develop a simpler equation by using the extend Leibniz integral rule for a constant density and result in

$$\overbrace{\frac{d}{dt} \int_{c.v.} \rho dV}^{\text{thus, } =0} = \int_{c.v.} \overbrace{\frac{d\rho}{dt}}^{=0} dV + \rho \int_{S_{c.v.}} \hat{n} \cdot U_b dA = \rho \int_{S_{c.v.}} U_{bn} dA \quad (5.14)$$

where  $U_b$  is the boundary velocity and  $U_{bn}$  is the normal component of the boundary velocity.

**Steady State Continuity Deformable**

$$\int_{S_{c.v.}} U_{bn} dA = \int_{S_{c.v.}} U_{rn} dA \quad (5.15)$$

The meaning of the equation (5.15) is the net growth (or decrease) of the Control volume is by net volume flow into it. Example 5.2 illustrates this point.

**Example 5.2:**

*Liquid fills a bucket as shown in Figure 5.5. The average velocity of the liquid at the exit of the filling pipe is  $U_p$  and cross section of the pipe is  $A_p$ . The liquid fills a bucket with cross section area of  $\mathbf{A}$  and instantaneous height is  $h$ . Find the height as a function of the other parameters. Assume that the density is constant and at the boundary interface  $A_j = 0.7 A_p$ . And where  $A_j$  is the area of jet when touching the*

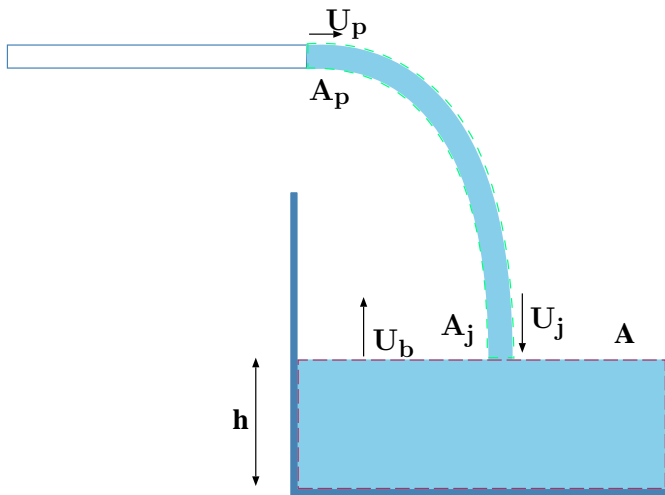

Fig. -5.5. Filling of the bucket and choices of the deformable control volumes for example 5.2.

liquid boundary in bucket. The last assumption is result of the energy equation (with some influence of momentum equation). The relationship is function of the distance of the pipe from the boundary of the liquid. However, this effect can be neglected for this range which this problem. In reality, the ratio is determined by height of the pipe from the liquid surface in the bucket. Calculate the bucket liquid interface velocity.

#### SOLUTION

This problem requires two deformable control volumes. The first control is around the jet and second is around the liquid in the bucket. In this analysis, several assumptions must be made. First, no liquid leaves the jet and enters the air. Second, the liquid in the bucket has a straight surface. This assumption is a strong assumption for certain conditions but it will be not discussed here since it is advance topic. Third, there are no evaporation or condensation processes. Fourth, the air effects are negligible. The control volume around the jet is deformable because the length of the jet shrinks with the time. The mass conservation of the liquid in the bucket is

$$\overbrace{\int_{c.v.} U_{bn} dA}^{\text{boundary change}} = \overbrace{\int_{c.v.} U_{rn} dA}^{\text{flow in}}$$

where  $U_{bn}$  is the perpendicular component of velocity of the boundary. Substituting the known values for  $U_{rn}$  results in

$$\int_{c.v.} U_b dA = \int_{c.v.} \overbrace{(U_j + U_b)}^{U_{rn}} dA$$

The integration can be carried when the area of jet is assumed to be known as

$$U_b A = A_j (U_j + U_b) \quad (5.11.a)$$

To find the jet velocity,  $U_j$ , the second control volume around the jet is used as the following

$$\underbrace{U_p A_p}_{\text{flow in}} - \underbrace{A_j (U_b + U_j)}_{\text{flow out}} = \underbrace{-A_j U_b}_{\text{boundary change}} \quad (5.11.b)$$

The above two equations (5.11.a) and (5.11.b) are enough to solve for the two unknowns. Substituting the first equation, (5.11.a) into (5.11.b) and using the ratio of  $A_j = 0.7 A_p$  results

$$U_p A_p - U_b A = -0.7 A_p U_b \quad (5.11.c)$$

The solution of equation (5.11.c) is

$$U_b = \frac{A_p}{A - 0.7 A_p}$$

It is interesting that many individuals intuitively will suggest that the solution is  $U_b A_p / A$ . When examining solution there are two limits. The first limit is when  $A_p = A/0.7$  which is

$$U_b = \frac{A_p}{0} = \infty$$

The physical meaning is that surface is filled instantly. The other limit is that and  $A_p/A \rightarrow 0$  then

$$U_b = \frac{A_p}{A}$$

which is the result for the “intuitive” solution. It also interesting to point out that if the filling was from other surface (not the top surface), e.g. the side, the velocity will be  $U_b = U_p$  in the limiting case and not infinity. The reason for this difference is that the liquid already fill the bucket and has not to move into bucket.

---

End Solution

---

**Example 5.3:**

*Balloon is attached to a rigid supply in which is supplied by a constant the mass rate,  $m_i$ . Calculate the velocity of the balloon boundaries assuming constant density.*

SOLUTION

The applicable equation is

$$\int_{c.v.} U_{bn} dA = \int_{c.v.} U_{rn} dA$$

The entrance is fixed, thus the relative velocity,  $U_{rn}$  is

$$U_{rn} = \begin{cases} -U_p & \text{@ the valve} \\ 0 & \text{every else} \end{cases}$$



Assume equal distribution of the velocity in balloon surface and that the center of the balloon is moving, thus the velocity has the following form

$$U_b = U_x \hat{x} + U_{br} \hat{r}$$

Where  $\hat{x}$  is unit coordinate in  $x$  direction and  $U_x$  is the velocity of the center and where  $\hat{r}$  is unit coordinate in radius from the center of the balloon and  $U_{br}$  is the velocity in that direction. The right side of equation (5.15) is the net change due to the boundary is

$$\int_{S_{c.v.}} (U_x \hat{x} + U_{br} \hat{r}) \cdot \hat{n} dA = \overbrace{\int_{S_{c.v.}} (U_x \hat{x}) \cdot \hat{n} dA}^{\text{center movement}} + \overbrace{\int_{S_{c.v.}} (U_{br} \hat{r}) \cdot \hat{n} dA}^{\text{net boundary change}}$$

The first integral is zero because it is like movement of solid body and also yield this value mathematically (excises for mathematical oriented student). The second integral (notice  $\hat{n} = \hat{r}$ ) yields

$$\int_{S_{c.v.}} (U_{br} \hat{r}) \cdot \hat{n} dA = 4 \pi r^2 U_{br}$$

Substituting into the general equation yields

$$\rho \overbrace{4 \pi r^2}^A U_{br} = \rho U_p A_p = m_i$$

Hence,

$$U_{br} = \frac{m_i}{\rho 4 \pi r^2}$$

The center velocity is (also) exactly  $U_{br}$ . The total velocity of boundary is

$$U_t = \frac{m_i}{\rho 4 \pi r^2} (\hat{x} + \hat{r})$$

It can be noticed that the velocity at the opposite to the connection to the rigid pipe which is double of the center velocity.

---

End Solution

---

### 5.3.2.3 One-Dimensional Control Volume

Additional simplification of the continuity equation is of one dimensional flow. This simplification provides very useful description for many fluid flow phenomena. The main assumption made in this model is that the properties in the across section are only function of  $x$  coordinate . This assumptions leads

$$\int_{A_2} \rho_2 U_2 dA - \int_{A_1} \rho_1 U_1 dA = \frac{d}{dt} \int_{V(x)} \rho(x) \overbrace{A(x) dx}^{dV} \quad (5.16)$$

When the density can be considered constant equation (5.16) is reduced to

$$\int_{A_2} U_2 dA - \int_{A_1} U_1 dA = \frac{d}{dt} \int A(x) dx \quad (5.17)$$

For steady state but with variations of the velocity and variation of the density reduces equation (5.16) to become

$$\int_{A_2} \rho_2 U_2 dA = \int_{A_1} \rho_1 U_1 dA \quad (5.18)$$

For steady state and uniform density and velocity equation (5.18) reduces further to

$$\rho_1 A_1 U_1 = \rho_2 A_2 U_2 \quad (5.19)$$

For incompressible flow (constant density), continuity equation is at its minimum form of

$$U_1 A_1 = A_2 U_2 \quad (5.20)$$

The next example is of semi one-dimensional example to illustrate equation (5.16).

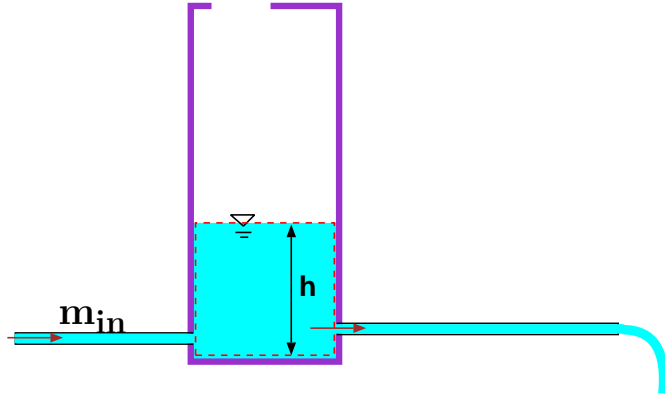

Fig. -5.6. Height of the liquid for example 5.4.

**Example 5.4:**

Liquid flows into tank in a constant mass flow rate of  $a$ . The mass flow rate out is function of the height. First assume that  $q_{out} = b h$  second Assume as  $q_{out} = b \sqrt{h}$ . For the first case, determine the height,  $h$  as function of the time. Is there a critical value and then if exist find the critical value of the system parameters. Assume that the height at time zero is  $h_0$ . What happen if the  $h_0 = 0$ ?

SOLUTION

The control volume for both cases is the same and it is around the liquid in the tank. It can be noticed that control volume satisfy the demand of one dimensional since the flow is only function of  $x$  coordinate. For case one the right hand side term in equation (5.16) is

$$\rho \frac{d}{dt} \int_0^L h dx = \rho L \frac{dh}{dt}$$

Substituting into equation equation (5.16) is

$$\rho L \frac{dh}{dt} = \overbrace{b_1 h}^{\text{flow out}} - \overbrace{m_i}^{\text{flow in}}$$

solution is

$$h = \overbrace{\frac{m_i}{b_1} e^{-\frac{b_1 t}{\rho L}}}^{\text{homogeneous solution}} + \overbrace{c_1 e^{\frac{b_1 t}{\rho L}}}^{\text{private solution}}$$

The solution has the homogeneous solution (solution without the  $m_i$ ) and the solution of the  $m_i$  part. The solution can rearranged to a new form (a discussion why this form is preferred will be provided in dimensional chapter).

$$\frac{h b_1}{m_1} = e^{-\frac{b_1 t}{\rho L}} + c e^{\frac{b_1 t}{\rho L}}$$

With the initial condition that at  $h(t=0) = h_0$  the constant coefficient can be found as

$$\frac{h_0 b_1}{m_1} = 1 - c \implies c = 1 - \frac{h_0 b_1}{m_i}$$

which the solution is

$$\frac{h b_1}{m_1} = e^{-\frac{b_1 t}{\rho L}} + \left[ 1 - \frac{h_0 b_1}{m_i} \right] e^{\frac{b_1 t}{\rho L}}$$

It can be observed that if  $1 = \frac{h_0 b_1}{m_i}$  is the critical point of this solution. If the term  $\frac{h_0 b_1}{m_i}$  is larger than one then the solution reduced to a negative number. However, negative number for height is not possible and the height solution approach zero. If the reverse case appeared, the height will increase. Essentially, the critical ratio state if the flow in is larger or lower than the flow out determine the condition of the height.

For second case, the governing equation (5.16) is

$$\rho L \frac{dh}{dt} = \overbrace{b \sqrt{h}}^{\text{flow out}} - \overbrace{m_i}^{\text{flow in}}$$

with the general solution of

$$\ln \left[ \left( \frac{\sqrt{h} b}{m_i} - 1 \right) \frac{m_i}{\rho L} \right] + \frac{\sqrt{h} b}{m_i} - 1 = (t + c) \frac{\sqrt{h} b}{2 \rho L}$$

The constant is obtained when the initial condition that at  $h(t = 0) = h_0$  and it left as exercise for the reader.

---

End Solution

---

## 5.4 Reynolds Transport Theorem

It can be noticed that the same derivations carried for the density can be carried for other intensive properties such as specific entropy, specific enthalpy. Suppose that  $g$  is intensive property (which can be a scalar or a vector) undergoes change with time. The change of accumulative property will be then

$$\frac{D}{Dt} \int_{sys} f \rho dV = \frac{d}{dt} \int_{c.v.} f \rho dV + \int_{c.v.} f \rho U_{rn} dA \quad (5.21)$$

This theorem named after Reynolds, Osborne, (1842-1912) which is actually a three dimensional generalization of Leibniz integral rule<sup>1</sup>. To make the previous derivation clearer, the Reynolds Transport Theorem will be reproofed and discussed. The ideas are the similar but extended some what.

Leibniz integral rule<sup>2</sup> is a one dimensional and it is defined as

$$\frac{d}{dy} \int_{x_1(y)}^{x_2(y)} f(x, y) dx = \int_{x_1(y)}^{x_2(y)} \frac{\partial f}{\partial y} dx + f(x_2, y) \frac{dx_2}{dy} - f(x_1, y) \frac{dx_1}{dy} \quad (5.22)$$

Initially, a proof will be provided and the physical meaning will be explained. Assume that there is a function that satisfy the following

$$G(x, y) = \int^x f(\alpha, y) d\alpha \quad (5.23)$$

Notice that lower boundary of the integral is missing and is only the upper limit of the function is present<sup>3</sup>. For its derivative of equation (5.23) is

$$f(x, y) = \frac{\partial G}{\partial x} \quad (5.24)$$

differentiating (chain rule  $duv = u dv + v du$ ) by part of left hand side of the Leibniz integral rule (it can be shown which are identical) is

$$\frac{d [G(x_2, y) - G(x_1, y)]}{dy} = \overbrace{\frac{\partial G}{\partial x_2} \frac{dx_2}{dy}}^1 + \overbrace{\frac{\partial G}{\partial y}(x_2, y)}^2 - \overbrace{\frac{\partial G}{\partial x_1} \frac{dx_1}{dy}}^3 - \overbrace{\frac{\partial G}{\partial y}(x_1, y)}^4 \quad (5.25)$$

<sup>1</sup>These papers can be read on-line at <http://www.archive.org/details/papersonmechanic01reynrich>.

<sup>2</sup>This material is not necessarily but is added her for completeness. This author find material just given so no questions will be asked.

<sup>3</sup>There was a suggestion to insert arbitrary constant which will be canceled and will a provide rigorous proof. This is engineering book and thus, the exact mathematical proof is not the concern here. Nevertheless, if there will be a demand for such, it will be provided.

The terms 2 and 4 in equation (5.25) are actually (the  $x_2$  is treated as a different variable)

$$\int_{x_1(y)}^{x_2(y)} \frac{\partial f(x, y)}{\partial y} dx \quad (5.26)$$

The first term (1) in equation (5.25) is

$$\frac{\partial G}{\partial x_2} \frac{dx_2}{dy} = f(x_2, y) \frac{dx_2}{dy} \quad (5.27)$$

The same can be said for the third term (3). Thus this explanation is a proof the Leibniz rule.

The above "proof" is mathematical in nature and physical explanation is also provided. Suppose that a fluid is flowing in a conduit. The intensive property,  $f$  is investigated or the accumulative property,  $F$ . The interesting information that commonly needed is the change of the accumulative property,  $F$ , with time. The change with time is

$$\frac{DF}{Dt} = \frac{D}{Dt} \int_{sys} \rho f dV \quad (5.28)$$

For one dimensional situation the change with time is

$$\frac{DF}{Dt} = \frac{D}{Dt} \int_{sys} \rho f A(x) dx \quad (5.29)$$

If two limiting points (for the one dimensional) are moving with a different coordinate system, the mass will be different and it will not be a system. This limiting condition is the control volume for which some of the mass will leave or enter. Since the change is very short (differential), the flow in (or out) will be the velocity of fluid minus the boundary at  $x_1$ ,  $U_{rn} = U_1 - U_b$ . The same can be said for the other side. The accumulative flow of the property in,  $F$ , is then

$$F_{in} = \overbrace{f_1 \rho}^{F_1} \overbrace{U_{rn}}^{\frac{dx_1}{dt}} \quad (5.30)$$

The accumulative flow of the property out,  $F$ , is then

$$F_{out} = \overbrace{f_2 \rho}^{F_2} \overbrace{U_{rn}}^{\frac{dx_2}{dt}} \quad (5.31)$$

The change with time of the accumulative property,  $F$ , between the boundaries is

$$\frac{d}{dt} \int_{c.v.} \rho(x) f A(x) dA \quad (5.32)$$

When put together it brings back the Leibniz integral rule. Since the time variable,  $t$ , is arbitrary and it can be replaced by any letter. The above discussion is one of the physical meaning the Leibniz rule.

Reynolds Transport theorem is a generalization of the Leibniz rule and thus the same arguments are used. The only difference is that the velocity has three components and only the perpendicular component enters into the calculations.

Reynolds Transport

$$\frac{D}{DT} \int_{sys} f \rho dV = \frac{d}{dt} \int_{c.v} f \rho dV + \int_{S_{c.v.}} f \rho U_{rn} dA \quad (5.33)$$

## 5.5 Examples For Mass Conservation

Several examples are provided to illustrate the topic.

Example 5.5:

*Liquid enters a circular pipe with a linear velocity profile as a function of the radius with maximum velocity of  $U_{max}$ . After magical mixing, the velocity became uniform. Write the equation which describes the velocity at the entrance. What is the magical averaged velocity at the exit? Assume no-slip condition.*

### SOLUTION

The velocity profile is linear with radius. Additionally, later a discussion on relationship between velocity at interface to solid also referred as the (no) slip condition will be provided. This assumption is good for most cases with very few exceptions. It will be assumed that the velocity at the interface is zero. Thus, the boundary condition is  $U(r = R) = 0$  and  $U(r = 0) = U_{max}$ . Therefore the velocity profile is

$$U(r) = U_{max} \left(1 - \frac{r}{R}\right)$$

Where  $R$  is radius and  $r$  is the working radius (for the integration). The magical averaged velocity is obtained using the equation (5.13). For which

$$\int_0^R U_{max} \left(1 - \frac{r}{R}\right) 2\pi r dr = U_{ave} \pi R^2 \quad (5.V.a)$$

The integration of the equation (5.V.a) is

$$U_{max} \pi \frac{R^2}{6} = U_{ave} \pi R^2 \quad (5.V.b)$$

The solution of equation (b) results in average velocity as

$$U_{ave} = \frac{U_{max}}{6} \quad (5.V.c)$$

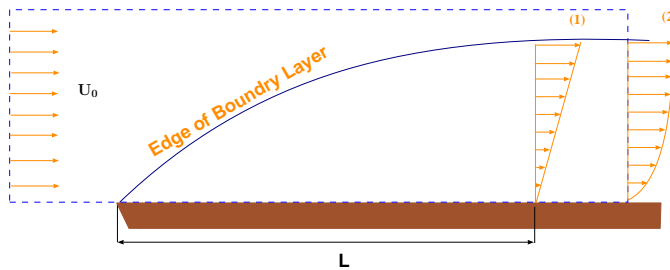

Fig. -5.7. Boundary Layer control mass.

Example 5.6:

Experiments have shown that a layer of liquid that attached itself to the surface and it is referred to as boundary layer. The assumption is that fluid attaches itself to surface. The slowed liquid is slowing the layer above it. The boundary layer is growing with  $x$  because the boundary effect is penetrating further into fluid. A common boundary layer analysis uses the Reynolds transform theorem. In this case, calculate the relationship of the mass transfer across the control volume. For simplicity assume slowed fluid has a linear velocity profile. Then assume parabolic velocity profile as

$$U_x(y) = 2U_0 \left[ \frac{y}{\delta} + \frac{1}{2} \left( \frac{y}{\delta} \right)^2 \right]$$

and calculate the mass transfer across the control volume. Compare the two different velocity profiles affecting on the mass transfer.

SOLUTION

Assuming the velocity profile is linear thus, (to satisfy the boundary condition) it will be

$$U_x(y) = \frac{U_0 y}{\delta}$$

The chosen control volume is rectangular of  $L \times \delta$ . Where  $\delta$  is the height of the boundary layer at exit point of the flow as shown in Figure 5.7. The control volume has three surfaces that mass can cross, the left, right, and upper. No mass can cross the lower surface (solid boundary). The situation is steady state and thus using equation (5.13) results in

$$\overbrace{\int_0^\delta U_0 dy}^{\text{in}} - \overbrace{\int_0^\delta \frac{U_0 y}{\delta} dy}^{\text{out}} = \overbrace{\int_0^L U_x dx}^{\text{y direction}}$$

It can be noticed that the convention used in this chapter of “in” as negative is not “followed.” The integral simply multiply by negative one. The above integrals on the

right hand side can be combined as

$$\int_0^\delta U_0 \left(1 - \frac{y}{\delta}\right) dy = \int_0^L U dx$$

the integration results in

$$\frac{U_0 \delta}{2} = \int_0^L U dx$$

or for parabolic profile

$$\int_0^\delta U_0 dy - \int_0^\delta U_0 \left[\frac{y}{\delta} + \left(\frac{y}{\delta}\right)^2\right] dy = \int_0^L U dx$$

or

$$\int_0^\delta U_0 \left[1 - \frac{y}{\delta} - \left(\frac{y}{\delta}\right)^2\right] dy = U_0$$

the integration results in

$$\frac{U_0 \delta}{2} = \int_0^L U dx$$

---

End Solution

---

**Example 5.7:**

*Air flows into a jet engine at 5 kg/sec while fuel flow into the jet is at 0.1 kg/sec. The burned gases leaves at the exhaust which has cross area 0.1 m<sup>2</sup> with velocity of 500 m/sec. What is the density of the gases at the exhaust?*

SOLUTION

The mass conservation equation (5.13) is used. Thus, the flow out is ( 5 + 0.1 ) 5.1 kg/sec The density is

$$\rho = \frac{\dot{m}}{AU} = \frac{5.1 \text{ kg/sec}}{0.01 \text{ m}^2 \cdot 500 \text{ m/sec}} = 1.02 \text{ kg/m}^3$$

---

End Solution

---

The mass (volume) flow rate is given by direct quantity like  $x \text{ kg/sec}$ . However sometime, the mass (or the volume) is given by indirect quantity such as the effect of flow. The next example deal with such reversed mass flow rate.

**Example 5.8:**

*The tank is filled by two valves which one filled tank in 3 hours and the second by 6 hours. The tank also has three emptying valves of 5 hours, 7 hours, and 8 hours. The tank is 3/4 fulls, calculate the time for tank reach empty or full state when all the valves are open. Is there a combination of valves that make the tank at steady state?*



SOLUTION

Easier measurement of valve flow rate can be expressed as fraction of the tank per hour. For example valve of 3 hours can be converted to 1/3 tank per hour. Thus, mass flow rate in is

$$\dot{m}_{in} = 1/3 + 1/6 = 1/2 \text{ tank/hour}$$

The mass flow rate out is

$$\dot{m}_{out} = 1/5 + 1/7 + 1/8 = \frac{131}{280}$$

Thus, if all the valves are open the tank will be filled. The time to completely filled the tank is

$$\frac{1}{\frac{1}{2} - \frac{131}{280}} = \frac{70}{159} \text{ hour}$$

The rest is under construction.

---

End Solution

---

## Example 5.9:

*Inflated cylinder is supplied in its center with constant mass flow. Assume that the gas mass is supplied in uniform way of  $m_i$  [kg/m/sec]. Assume that the cylinder inflated uniformly and pressure inside the cylinder is uniform. The gas inside the cylinder obeys the ideal gas law. The pressure inside the cylinder is linearly proportional to the volume. For simplicity, assume that the process is isothermal. Calculate the cylinder boundaries velocity.*

SOLUTION

The applicable equation is

$$\overbrace{\int_{V_{c.v.}} \frac{d\rho}{dt} dV}^{\text{increase pressure}} + \overbrace{\int_{S_{c.v.}} \rho U_b dV}^{\text{boundary velocity}} = \overbrace{\int_{S_{c.v.}} \rho U_{rn} dA}^{\text{in or out flow rate}}$$

Every term in the above equation is analyzed but first the equation of state and volume to pressure relationship have to be provided.

$$\rho = \frac{P}{RT}$$

and relationship between the volume and pressure is

$$P = f \pi R_c^2$$

Where  $R_c$  is the instantaneous cylinder radius. Combining the above two equations results in

$$\rho = \frac{f \pi R_c^2}{RT}$$

Where  $f$  is a coefficient with the right dimension. It also can be noticed that boundary velocity is related to the radius in the following form

$$U_b = \frac{dR_c}{dt}$$

The first term requires to find the derivative of density with respect to time which is

$$\frac{d\rho}{dt} = \frac{d}{dt} \left( \frac{f \pi R_c^2}{RT} \right) = \frac{2 f \pi R_c}{RT} \overbrace{\frac{dR_c}{dt}}^{U_b}$$

Thus the first term is

$$\int_{V_{c.v.}} \frac{d\rho}{dt} \overbrace{dV}^{2 \pi R_c} = \int_{V_{c.v.}} \frac{2 f \pi R_c}{RT} U_b \overbrace{dV}^{2 \pi R_c dR_c} = \frac{4 f \pi^2 R_c^3}{3 RT} U_b$$

The integral can be carried when  $U_b$  is independent of the  $R_c$ <sup>4</sup> The second term is

$$\int_{S_{c.v.}} \rho U_b dA = \overbrace{\frac{f \pi R_c^2}{RT}}^{\rho} U_b \overbrace{2 \pi R_c}^A = \left( \frac{f \pi^3 R_c^2}{RT} \right) U_b$$

substituting in the governing equation obtained the form of

$$\frac{f \pi^2 R_c^3}{RT} U_b + \frac{4 f \pi^2 R_c^3}{3 RT} U_b = m_i$$

The boundary velocity is then

$$U_b = \frac{m_i}{\frac{7 f \pi^2 R_c^3}{3 RT}} G = \frac{3 m_i RT}{7 f \pi^2 R_c^3}$$

---

End Solution

#### Example 5.10:

A balloon is attached to a rigid supply and is supplied by a constant mass rate,  $m_i$ . Assume that gas obeys the ideal gas law. Assume that balloon volume is a linear function of the pressure inside the balloon such as  $P = f_v V$ . Where  $f_v$  is a coefficient describing the balloon physical characters. Calculate the velocity of the balloon boundaries under the assumption of isothermal process.

<sup>4</sup>The proof of this idea is based on the chain differentiation similar to Leibniz rule. When the derivative of the second part is  $dU_b/dR_c = 0$ .

SOLUTION

The question is more complicated than Example 5.10. The ideal gas law is

$$\rho = \frac{P}{RT}$$

The relationship between the pressure and volume is

$$P = f_v V = \frac{4 f_v \pi R_b^3}{3}$$

The combining of the ideal gas law with the relationship between the pressure and volume results

$$\rho = \frac{4 f_v \pi R_b^3}{3 R T}$$

The applicable equation is

$$\int_{V_{c.v.}} \frac{d\rho}{dt} dV + \int_{S_{c.v.}} \rho (U_c \hat{x} + U_b \hat{r}) dA = \int_{S_{c.v.}} \rho U_{rn} dA$$

The right hand side of the above equation is

$$\int_{S_{c.v.}} \rho U_{rn} dA = m_i$$

The density change is

$$\frac{d\rho}{dt} = \frac{12 f_v \pi R_b^2}{RT} \overbrace{\frac{dR_b}{dt}}^{U_b}$$

The first term is

$$\int_0^{R_b} \overbrace{\frac{12 f_v \pi R_b^2}{RT}}^{\neq f(r)} U_b \overbrace{4 \pi r^2 dr}^{dV} = \frac{16 f_v \pi^2 R_b^5}{3 R T} U_b$$

The second term is

$$\int_A \frac{4 f_v \pi R_b^3}{3 R T} U_b dA = \frac{4 f_v \pi R_b^3}{3 R T} U_b \overbrace{4 \pi R_b^2}^A = \frac{8 f_v \pi^2 R_b^5}{3 R T} U_b$$

Substituting the two equations of the applicable equation results

$$U_b = \frac{1}{8} \frac{m_i R T}{f_v \pi^2 R_b^5}$$

Notice that first term is used to increase the pressure and second the change of the boundary.

**Open Question: Answer must be received by April 15, 2010**

The best solution of the following question will win 18 U.S. dollars and your name will be associated with the solution in this book.

**Example 5.11:**

Solve example 5.10 under the assumption that the process is isentropic. Also assume that the relationship between the pressure and the volume is  $P = f_v V^2$ . What are the units of the coefficient  $f_v$  in this problem? What are the units of the coefficient in the previous problem?

**5.6 The Details Picture – Velocity Area Relationship**

The integral approach is intended to deal with the “big” picture. Indeed the method is used in this part of the book for this purpose. However, there is very little written about the usability of this approach to provide way to calculate the average quantities in the control system. Sometimes it is desirable to find the averaged velocity or velocity distribution inside a control volume. There is no general way to provide these quantities. Therefore an example will be provided to demonstrate the use of this approach.

Consider a container filled with liquid on which one exit opened and the liquid flows out as shown in Figure 5.8. The velocity has three components in each of the coordinates under the assumption that flow is uniform and the surface is straight<sup>5</sup>. The integral approach is used to calculate the averaged velocity of each to the components. To relate the velocity in the  $z$  direction with the flow rate out or the exit the velocity mass balance is constructed. A similar control volume construction to find the velocity of the boundary velocity (height) can be carried out. The control volume is bounded by the container wall including the exit of the flow. The upper boundary is surface parallel to upper surface but at  $Z$  distance from the bottom. The mass balance reads

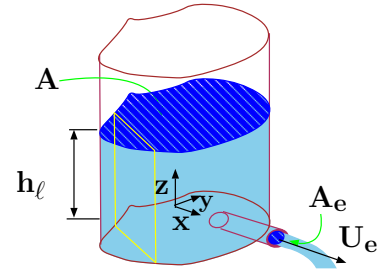

Fig. -5.8. Control volume usage to calculate local averaged velocity in three coordinates.

$$\int_V \frac{d\rho}{dt} dV + \int_A U_{bn} \rho dA + \int_A U_{rn} \rho dA = 0 \quad (5.34)$$

<sup>5</sup>The liquid surface is not straight for this kind of problem. However, under certain conditions it is reasonable to assume straight surface which have been done for this problem.

For constant density (conservation of volume) equation<sup>6</sup> and ( $h > z$ ) reduces to

$$\int_A U_{rn} \rho dA = 0 \tag{5.35}$$

In the container case for uniform velocity equation 5.35 becomes

$$U_z A = U_e A_e \implies U_z = -\frac{A_e}{A} U_e \tag{5.36}$$

It can be noticed that the boundary is not moving and the mass inside does not change this control volume. The velocity  $U_z$  is the averaged velocity downward.

The  $x$  component of velocity is obtained by using a different control volume. The control volume is shown in Figure 5.9. The boundary are the container far from the flow exit with blue line projection into page (area) shown in the Figure 5.9. The mass conservation for constant density of this control volume is

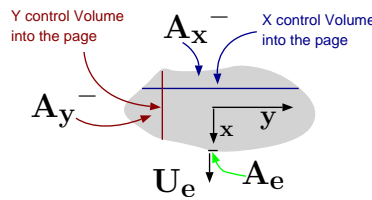

Fig. -5.9. Control volume and system before and after the motion.

$$-\int_A U_{bn} \rho dA + \int_A U_{rn} \rho dA = 0 \tag{5.37}$$

Usage of control volume not included in the previous analysis provides the velocity at the upper boundary which is the same as the velocity at  $y$  direction. Substituting into (5.37) results in

$$\int_{A_x^-} \frac{A_e}{A} U_e \rho dA + \int_{A_{yz}} U_x \rho dA = 0 \tag{5.38}$$

Where  $A_x^-$  is the area shown the Figure under this label. The area  $A_{yz}$  referred to area into the page in Figure 5.9 under the blue line. Because averaged velocities and constant density are used transformed equation (5.38) into

$$\frac{A_e}{A} A_x^- U_e + U_x \overbrace{Y(x) h}^{A_{yz}} = 0 \tag{5.39}$$

Where  $Y(x)$  is the length of the (blue) line of the boundary. It can be notice that the velocity,  $U_x$  is generally increasing with  $x$  because  $A_x^-$  increase with  $x$ .

The calculations for the  $y$  directions are similar to the one done for  $x$  direction. The only difference is that the velocity has two different directions. One zone is right to the exit with flow to the left and one zone to left with averaged velocity to right. If the volumes on the left and the right are symmetrical the averaged velocity will be zero.

<sup>6</sup>The point where ( $z = h$ ) the boundary term is substituted the flow in term.

Example 5.12:

Calculate the velocity,  $U_x$  for a cross section of circular shape (cylinder).

SOLUTION

The relationship for this geometry needed to be expressed. The length of the line  $Y(x)$  is

$$Y(x) = 2r \sqrt{1 - \left(1 - \frac{x}{r}\right)^2} \quad (5.XII.a)$$

This relationship also can be expressed in the term of  $\alpha$  as

$$Y(x) = 2r \sin \alpha \quad (5.XII.b)$$

Since this expression is simpler it will be adapted. When the relationship between radius angle and  $x$  are

$$x = r(1 - \sin \alpha) \quad (5.XII.c)$$

The area  $A_x^-$  is expressed in term of  $\alpha$  as

$$A_x^- = \left(\alpha - \frac{1}{2} \sin(2\alpha)\right) r^2 \quad (5.XII.d)$$

Thus the velocity,  $U_x$  is

$$\frac{A_e}{A} \left(\alpha - \frac{1}{2} \sin(2\alpha)\right) r^2 U_e + U_x 2r \sin \alpha h = 0 \quad (5.XII.e)$$

$$U_x = \frac{A_e r}{A h} \frac{\left(\alpha - \frac{1}{2} \sin(2\alpha)\right)}{\sin \alpha} U_e \quad (5.XII.f)$$

Averaged velocity is defined as

$$\bar{U}_x = \frac{1}{S} \int_S U dS \quad (5.XII.g)$$

Where here  $S$  represent some length. The same way it can be represented for angle calculations. The value  $dS$  is  $r \cos \alpha$ . Integrating the velocity for the entire container and dividing by the angle,  $\alpha$  provides the averaged velocity.

$$\bar{U}_x = \frac{1}{2r} \int_0^\pi \frac{A_e r}{A h} \frac{\left(\alpha - \frac{1}{2} \sin(2\alpha)\right)}{\tan \alpha} U_e r d\alpha \quad (5.XII.h)$$

which results in

$$\bar{U}_x = \frac{(\pi - 1)}{4} \frac{A_e r}{A h} U_e \quad (5.XII.i)$$

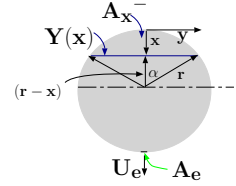

Fig. -5.10. Circular cross section for finding  $U_x$  and various cross sections.

---

End Solution

Example 5.13:

Calculate the velocity,  $U_y$  for a cross section of circular shape (cylinder). What is the averaged velocity if only half section is used. State your assumptions and how it similar to the previous example.

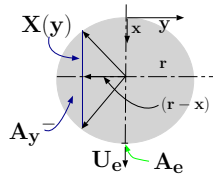

Fig. -5.11.  $y$  velocity for a circular shape

SOLUTION

The flow out in the  $x$  direction is zero because symmetrical reasons. That is the flow field is a mirror images. Thus, every point has different velocity with the same value in the opposite direction.

The flow in half of the cylinder either the right or the left has non zero averaged velocity. The calculations are similar to those in the previous to example 5.12. The main concept that must be recognized is the half of the flow must have come from one side and the other come from the other side. Thus, equation (5.39) modified to be

$$\frac{A_e}{A} A_x^{-} U_e + U_x \overbrace{Y(x) h}^{A_{yz}} = 0 \tag{5.40}$$

The integral is the same as before but the upper limit is only to  $\pi/2$

$$\overline{U}_x = \frac{1}{2r} \int_0^{\pi/2} \frac{A_e r}{A h} \frac{(\alpha - \frac{1}{2} \sin(2\alpha))}{\tan \alpha} U_e r d\alpha \tag{5.XIII.a}$$

which results in

$$\overline{U}_x = \frac{(\pi - 2)}{8} \frac{A_e r}{A h} U_e \tag{5.XIII.b}$$

---

End Solution

### 5.7 More Examples for Mass Conservation

Typical question about the relative velocity that appeared in many fluid mechanics exams is the following.

Example 5.14:

A boat travels at speed of 10m/sec upstream in a river that flows at a speed of 5m/s. The inboard engine uses a pump to suck in water at the front  $A_{in} = 0.2 m^2$  and eject it through the back of the boat with exist area of  $A_{out} = 0.05 m^2$ . The water absolute velocity leaving the back is 50m/sec, what are the relative velocities entering and leaving the boat and the pumping rate?

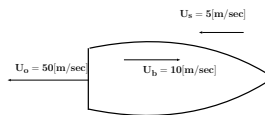

Fig. -5.12. Schematic of the boat for example 5.14

SOLUTION

The boat is assumed (implicitly is stated) to be steady state and the density is constant. However, the calculation have to be made in the frame of reference moving with the boat. The relative jet discharge velocity is

$$U_{r_{out}} = 50 - (10 + 5) = 35[m/sec]$$

The volume flow rate is then

$$Q_{out} = A_{out} U_{r_{out}} = 35 \times 0.05 = 1.75m^3/sec$$

The flow rate at entrance is the same as the exit thus,

$$U_{r_{in}} = \frac{A_{out}}{A_{in}} U_{r_{out}} = \frac{0.05}{0.2} 35 = 8.75m/sec$$

---

End Solution

---

**Example 5.15:**

Liquid A enters a mixing device depicted in at  $0.1 [kg/s]$ . In same time liquid B enter the mixing device with a different specific density at  $0.05 [kg/s]$ . The density of liquid A is  $1000[kg/m^3]$  and liquid B is  $800[kg/m^3]$ . The results of the mixing is a homogeneous mixture. Assume incompressible process. Find the average leaving velocity and density of the mixture leaving through the  $20 [cm]$  diameter pipe. If the mixing device volume is decreasing (as a piston pushing into the chamber) at rate of  $.002 [m^3/s]$ , what is the exit velocity? State your assumptions.

SOLUTION

In the first scenario, the flow is steady state and equation (5.11) is applicable

$$\dot{m}_A + \dot{m}_B = \dot{Q}_{mix} \rho_{mix} \implies 0.1 + 0.05 = 0.15[m] \quad (5.XV.a)$$

Thus in this case, since the flow is incompressible flow, the total volume flow in is equal to volume flow out as

$$\dot{Q}_A + \dot{Q}_B = \dot{Q}_{mix} \implies \frac{\dot{m}_A}{\rho_A} + \frac{\dot{m}_B}{\rho_B} = \frac{0.10}{1000} + \frac{0.05}{800}$$

Thus the mixture density is

$$\rho_{mix} = \frac{\dot{m}_A + \dot{m}_B}{\frac{\dot{m}_A}{\rho_A} + \frac{\dot{m}_B}{\rho_B}} = 923.07[kg/m^3] \quad (5.XV.b)$$

The averaged velocity is then

$$U_{mix} = \frac{Q_{mix}}{A_{out}} = \frac{\frac{\dot{m}_A}{\rho_A} + \frac{\dot{m}_B}{\rho_B}}{\pi 0.01^2} = \frac{1.625}{\pi} [m/s] \quad (5.XV.c)$$



In the case that a piston is pushing the exit density could be changed and fluctuated depending on the location of the piston. However, if the assumption of well mixed is still holding the exit density should not be affected. The term that should be added to the governing equation is the change of the volume. So governing equation is (5.15).

$$\overbrace{U_{bn} A \rho_b}^{-Q_b \rho_{mix}} = \overbrace{\dot{m}_A + \dot{m}_B}^{in} - \overbrace{\dot{m}_{mix}}^{out} \quad (5.XV.d)$$

That is the mixture device is with an uniform density

$$\begin{aligned} -0.002[m/sec] 923.7[kg/m^3] &= 0.1 + 0.05 - m_{exit} & (5.XV.e) \\ m_{exit} &= 1.9974[kg/s] \end{aligned}$$

---

End Solution

---

Example 5.16:

A syringe apparatus is being used to withdraw blood<sup>7</sup>. If the piston is withdrawn at 0.01 [m/s]. At that stage air leaks in around the piston at the rate 0.000001 [m<sup>3</sup>/s]. What is the average velocity of blood into syringe (at the tip)? The syringe radius is 0.005[m] and the tip radius is 0.0003 [m].

SOLUTION

The situation is unsteady state (in the instinctive c.v. and coordinates) since the mass in the control volume (the syringe volume is not constant). The choice of the control volume and coordinate system determine the amount of work. This part of the solution is art. There are several possible control volumes that can be used to solve the problem. The two "instinctive control volumes" are the blood with the air and the whole volume between the tip and syringe plunger (piston). The first choice seems reasonable since it provides relationship of the total to specific material. In that case, control volume is the volume syringe tip to the edge of the blood. The second part of the control volume is the air. For this case, the equation (5.15) is applicable and can be written as

$$U_{tip} A_{tip} \rho_b = U_b A_s \rho_b \quad (5.XVI.a)$$

In the air side the same equation can be used. There are several coordinate systems that can be used, attached to plunger, attached to the blood edge, stationary. Notice that change of the volume does not enter into the calculations because the density of the air is assumed to be constant. In stationary coordinates two boundaries are moving and thus

$$\overbrace{U_{plunger} A_s \rho_a - U_b A_s \rho_b}^{\text{moving b.c.}} = \overbrace{\rho_a \dot{Q}_{in}}^{\text{in/out}} \quad (5.XVI.b)$$

<sup>7</sup>The author still remembers his elementary teacher that was so appalled by the discussion on blood piping which students in an engineering school were doing. He gave a speech about how inhuman these engineering students are. I hope that no one will have teachers like him. Yet, it can be observed that bioengineering is "cool" today while in 40 years ago it is a disgusting field.

In the case, the choice is coordinates moving with the plunger, the relative plunger velocity is zero while the blood edge boundary velocity is  $U_{plunger} - U_b$ . The air governing equation is

$$\overbrace{(U_{plunger} - U_b)}^{\text{blood b. velocity}} A_s \rho_b = \overbrace{\rho_a \dot{Q}_{in}}^{\text{in/out}} \quad (5.XVI.c)$$

In the case of coordinates are attached to the blood edge similar equation is obtained. At this stage, there are two unknowns,  $U_b$  and  $U_{tip}$ , and two equations. Using equations (5.XVI.a) and (5.XVI.c) results in

$$U_b = U_{plunger} - \frac{\rho_a Q_{in}}{A_s \rho_b} \quad (5.XVI.d)$$

$$U_{tip} = \frac{U_b A_s}{A_{tip}} = \frac{\left( U_{plunger} - \frac{\rho_a Q_{in}}{A_s \rho_b} \right) A_s}{A_{tip}}$$

---

End Solution

---

Example 5.17:

*The apparatus depicted in Figure ?? is referred in the literature sometime as the water-jet pump. In this device, the water (or another liquid) is pumped throw the inner pipe at high velocity. The outside pipe is lower pressure which suck the water (other liquid) into device. Later the two stream are mixed. In this question the what is the mixed stream averaged velocity with  $U_1 = 4.0[m/s]$  and  $U_2 = 0.5[m/s]$ . The cross section inside and outside radii ratio is  $r_1/r_2 = 0.2$ . Calculate the mixing averaged velocity.*

SOLUTION

The situation is steady state and which density of the liquid is irrelevant (because it is the same at the inside and outside).

$$U_1 A_1 + U_2 A_2 = U_3 A_3 \quad (5.XVII.a)$$

The velocity is  $A_3 = A_1 + A_2$  and thus

$$U_3 = \frac{U_1 A_1 + U_2 A_2}{A_3} = U_1 \frac{A_1}{A_3} + U_2 \left( 1 - \frac{A_1}{A_3} \right) \quad (5.XVII.b)$$

---

End Solution

---

---

---

# CHAPTER 6

---

## Momentum Conservation for Control Volume

### 6.1 Momentum Governing Equation

#### 6.1.1 Introduction to Continuous

In the previous chapter, the Reynolds Transport Theorem (RTT) was applied to mass conservation. Mass is a scalar (quantity without magnitude). This chapter deals with momentum conservation which is a vector. The Reynolds Transport Theorem (RTT) is applicable to any quantity and the discussion here will deal with forces that acting on the control volume. Newton's second law for single body is as the following

$$\mathbf{F} = \frac{d(m\mathbf{U})}{dt} \quad (6.1)$$

It can be noticed that bold notation for the velocity is  $\mathbf{U}$  (and not  $U$ ) to represent that the velocity has a direction. For several bodies ( $n$ ), Newton's law becomes

$$\sum_{i=1}^n \mathbf{F}_i = \sum_{i=1}^n \frac{d(m\mathbf{U})_i}{dt} \quad (6.2)$$

The fluid can be broken into infinitesimal elements which turn the above equation (6.2) into a continuous form of small bodies which results in

$$\sum_{i=1}^n \mathbf{F}_i = \frac{D}{Dt} \int_{sys} \mathbf{U} \overbrace{\rho dV}^{\text{element mass}} \quad (6.3)$$

Note that the notation  $D/Dt$  is used and not  $d/dt$  to signify that it referred to a derivative of the system. The Reynold's Transport Theorem (RTT) has to be used on the right hand side.

### 6.1.2 External Forces

First, the terms on the left hand side, or the forces, have to be discussed. The forces, excluding the external forces, are the body forces, and the surface forces as the following

$$\mathbf{F}_{total} = \mathbf{F}_b + \mathbf{F}_s \quad (6.4)$$

In this book (at least in this discussion), the main body force is the gravity. The gravity acts on all the system elements. The total gravity force is

$$\sum \mathbf{F}_b = \int_{sys} \mathbf{g} \overbrace{\rho dV}^{element\ mass} \quad (6.5)$$

which acts through the mass center towards the center of earth. After infinitesimal time the gravity force acting on the system is the same for control volume, hence,

$$\int_{sys} \mathbf{g} \rho dV = \int_{cv} \mathbf{g} \rho dV \quad (6.6)$$

The integral yields a force through the center mass which has to be found separately.

In this chapter, the surface forces are divided into two categories: one perpendicular to the surface and one with the surface direction (in the surface plain see Figure 6.1.). Thus, it can be written as

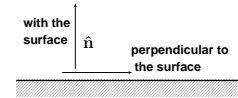

$$\sum \mathbf{F}_s = \int_{c.v.} \mathbf{S}_n dA + \int_{c.v.} \boldsymbol{\tau} dA \quad (6.7)$$

Fig. -6.1. The explanation for the direction relative to surface perpendicular and with the surface.

Where the surface "force",  $\mathbf{S}_n$ , is in the surface direction, and  $\boldsymbol{\tau}$  are the shear stresses. The surface "force",  $\mathbf{S}_n$ , is made out of two components, one due to viscosity (solid body) and two consequence of the fluid pressure. Here for simplicity, only the pressure component is used which is reasonable for most situations. Thus,

$$\mathbf{S}_n = -P \hat{n} + \overbrace{\mathbf{S}_\nu}^{\sim 0} \quad (6.8)$$

Where  $\mathbf{S}_\nu$  is perpendicular stress due to viscosity. Again,  $\hat{n}$  is an unit vector outward of element area and the negative sign is applied so that the resulting force acts on the body.

### 6.1.3 Momentum Governing Equation

The right hand side, according Reynolds Transport Theorem (RTT), is

$$\frac{D}{Dt} \int_{sys} \rho \mathbf{U} dV = \frac{t}{dt} \int_{c.v.} \rho \mathbf{U} dV + \int_{c.v.} \rho \mathbf{U} \mathbf{U}_{rn} dA \quad (6.9)$$

The liquid velocity,  $\mathbf{U}$ , is measured in the frame of reference and  $\mathbf{U}_{rn}$  is the liquid relative velocity to boundary of the control volume measured in the same frame of reference.

Thus, the general form of the momentum equation without the external forces is

Integral Momentum Equation

$$\int_{c.v.} \mathbf{g} \rho dV - \int_{c.v.} \mathbf{P} dA + \int_{c.v.} \boldsymbol{\tau} \cdot d\mathbf{A} = \frac{t}{dt} \int_{c.v.} \rho \mathbf{U} dV + \int_{c.v.} \rho \mathbf{U} \mathbf{U}_{rn} dV \quad (6.10)$$

With external forces equation (6.10) is transformed to

Integral Momentum Equation & External Forces

$$\sum \mathbf{F}_{ext} + \int_{c.v.} \mathbf{g} \rho dV - \int_{c.v.} \mathbf{P} \cdot d\mathbf{A} + \int_{c.v.} \boldsymbol{\tau} \cdot d\mathbf{A} = \frac{t}{dt} \int_{c.v.} \rho \mathbf{U} dV + \int_{c.v.} \rho \mathbf{U} \mathbf{U}_{rn} dV \quad (6.11)$$

The external forces,  $F_{ext}$ , are the forces resulting from support of the control volume by non-fluid elements. These external forces are commonly associated with pipe, ducts, supporting solid structures, friction (non-fluid), etc.

Equation (6.11) is a vector equation which can be broken into its three components. In Cartesian coordinate, for example in the  $x$  coordinate, the components are

$$\sum F_x + \int_{c.v.} (\mathbf{g} \cdot \hat{i}) \rho dV - \int_{c.v.} \mathbf{P} \cos \theta_x dA + \int_{c.v.} \boldsymbol{\tau}_x \cdot d\mathbf{A} = \frac{t}{dt} \int_{c.v.} \rho \mathbf{U}_x dV + \int_{c.v.} \rho \mathbf{U}_x \cdot \mathbf{U}_{rn} dA \quad (6.12)$$

where  $\theta_x$  is the angle between  $\hat{n}$  and  $\hat{i}$  or  $(\hat{n} \cdot \hat{i})$ .

### 6.1.4 Momentum Equation in Acceleration System

For accelerate system, the right hand side has to include the following acceleration

$$\mathbf{a}_{acc} = \boldsymbol{\omega} \times (\mathbf{r} \times \boldsymbol{\omega}) + 2\mathbf{U} \times \boldsymbol{\omega} + \mathbf{r} \times \dot{\boldsymbol{\omega}} - \mathbf{a}_0 \quad (6.13)$$

Where  $\mathbf{r}$  is the distance from the center of the frame of reference and the add force is

$$\mathbf{F}_{add} = \int_{V.c.v.} \mathbf{a}_{acc} \rho dV \quad (6.14)$$

### Integral of Uniform Pressure on Body

In this kind of calculations, it common to obtain a situation where one of the term will be an integral of the pressure over the body surface. This situation is a similar idea that was shown in Section 4.6. In this case the resulting force due to the pressure is zero to all directions.

## 6.1.5 Momentum For Steady State and Uniform Flow

The momentum equation can be simplified for the steady state condition as it was shown in example 6.3. The unsteady term (where the time derivative) is zero.

### Integral Steady State Momentum Equation

$$\sum \mathbf{F}_{ext} + \int_{c.v.} \mathbf{g} \rho dV - \int_{c.v.} \mathbf{P} dA + \int_{c.v.} \boldsymbol{\tau} dA = \int_{c.v.} \rho \mathbf{U} U_{rn} dA \quad (6.15)$$

### 6.1.5.1 Momentum for For Constant Pressure and Frictionless Flow

Another important sub category of simplification deals with flow under approximation of the frictionless flow and uniform pressure. This kind of situations arise when friction (forces) is small compared to kinetic momentum change. Additionally, in these situations, flow is exposed to the atmosphere and thus (almost) uniform pressure surrounding the control volume. In this situation, the mass flow rate in and out are equal. Thus, equation (6.15) is further reduced to

$$\mathbf{F} = \int_{out} \rho \mathbf{U} \overbrace{(\mathbf{U} \cdot \hat{n})}^{U_{rn}} dA - \int_{in} \rho \mathbf{U} \overbrace{(\mathbf{U} \cdot \hat{n})}^{U_{rn}} dA \quad (6.16)$$

In situations where the velocity is provided and known (remember that density is constant) the integral can be replaced by

$$\mathbf{F} = \dot{m} \overline{\mathbf{U}}_o - \dot{m} \overline{\mathbf{U}}_i \quad (6.17)$$

The average velocity is related to the velocity profile by the following integral

$$\overline{U}^2 = \frac{1}{A} \int_A [U(r)]^2 dA \quad (6.18)$$

Equation (6.18) is applicable to any velocity profile and any geometrical shape.

Example 6.1:

Calculate the average velocity for the given parabolic velocity profile for a circular pipe.

SOLUTION

The velocity profile is

$$U\left(\frac{r}{R}\right) = U_{max} \left[1 - \left(\frac{r}{R}\right)^2\right] \tag{6.1.a}$$

Substituting equation (6.1.a) into equation (6.18)

$$\bar{U}^2 = \frac{1}{2\pi R^2} \int_0^R [U(r)]^2 2\pi r dr \tag{6.1.b}$$

results in

$$\bar{U}^2 = (U_{max})^2 \int_0^1 (1 - \bar{r}^2)^2 \bar{r} d\bar{r} = \frac{1}{6} (U_{max})^2 \tag{6.1.c}$$

Thus,

$$\bar{U} = \frac{U_{max}}{\sqrt{6}}$$

End Solution

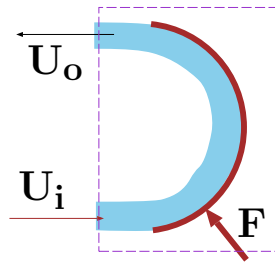
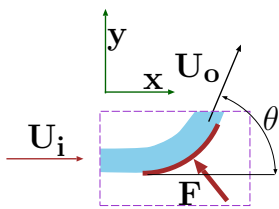

Fig a. Schematics of area impinged by a jet for example 6.2.

Fig b. Schematics of maximum angle for impinged by a jet.

Fig. -6.2. Schematics of area impinged by a jet and angle effects.

**Example 6.2:**

A jet is impinging on a stationary surface by changing only the jet direction (see Figure 6.2). Neglect the friction, calculate the force and the angle which the support has to apply to keep the system in equilibrium. What is the angle for which maximum force will be created?

SOLUTION

Equation (6.11) can be reduced, because it is a steady state, to

$$\mathbf{F} = \int_{out} \rho \mathbf{U} \overbrace{(\mathbf{U} \cdot \hat{n})}^{U_{rn}} dA - \int_{in} \rho \mathbf{U} \overbrace{(\mathbf{U} \cdot \hat{n})}^{U_{rn}} dA = \dot{m} \mathbf{U}_o - \dot{m} \mathbf{U}_i \tag{6.11.a}$$

It can be noticed that even though the velocity change direction, the mass flow rate remains constant. Equation (6.11.a) can be explicitly written for the two coordinates. The equation for the  $x$  coordinate is

$$F_x = \dot{m} (\cos \theta U_o - U_i)$$

or since  $U_i = U_o$

$$F_x = \dot{m} U_i (\cos \theta - 1)$$

It can be observed that the maximum force,  $F_x$  occurs when  $\cos \theta = -1$ . It can be proved by setting  $dF_x/d\theta = 0$  which yields  $\theta = 0$  a minimum and the previous solution. Hence

$$F_x|_{max} = -2 \dot{m} U_i$$

and the force in the  $y$  direction is

$$F_y = \dot{m} U_i \sin \theta$$

the combined forces are

$$F_{total} = \sqrt{F_x^2 + F_y^2} = \dot{m} U_i \sqrt{(\cos \theta - 1)^2 + \sin^2 \theta}$$

Which results in

$$F_{total} = \dot{m} U_i \sin(\theta/2)$$

with the force angle of

$$\tan \phi = \frac{F_y}{F_x} = \frac{\sin \theta}{\cos \theta - 1} = \frac{\pi}{2} - \frac{\theta}{2}$$

For angle between  $0 < \theta < \pi$  the maximum occur at  $\theta = \pi$  and the minimum at  $\theta \sim 0$ . For small angle analysis is important in the calculations of flow around thin wings.

---

End Solution

Example 6.3:

*Liquid flows through a symmetrical nozzle as shown in the Figure 6.3 with a mass*



### 6.1. MOMENTUM GOVERNING EQUATION

flow rate of  $0.01 [gk/sec]$ . The entrance pressure is  $3[Bar]$  and the entrance velocity is  $5 [m/sec]$ . The exit velocity is uniform but unknown. The exit pressure is  $1[Bar]$ . The entrance area is  $0.0005[m^2]$  and the exit area is  $0.0001[cm^2]$ . What is the exit velocity? What is the force acting the nozzle? Assume that the density is constant  $\rho = 1000[kg/m^3]$  and the volume in the nozzle is  $0.0015 [m^3]$ .

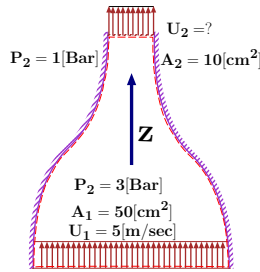

Fig. -6.3. Nozzle schematic for the discussion on the forces and for example 6.3.

#### SOLUTION

The chosen control volume is shown in Figure 6.3. First, the velocity has to be found. This situation is a steady state for constant density. Then

$$A_1 U_1 = A_2 U_2$$

and after rearrangement, the exit velocity is

$$U_2 = \frac{A_1}{A_2} U_1 = \frac{0.0005}{0.0001} \times 5 = 25 [m/sec]$$

Equation (6.12) is applicable but should be transformed into the  $z$  direction which is

$$\sum F_z + \int_{c.v.} \mathbf{g} \cdot \hat{k} \rho dV + \int_{c.v.} \mathbf{P} \cos \theta_z dA + \int_{c.v.} \boldsymbol{\tau}_z dA = \underbrace{0}_{=0} + \frac{t}{dt} \int_{c.v.} \rho \mathbf{U}_z dV + \int_{c.v.} \rho \mathbf{U}_z \cdot \mathbf{U}_{rn} dA \tag{6.III.a}$$

The control volume does not cross any solid body (or surface) there is no external forces. Hence,

$$\underbrace{\sum F_z}_{=0} + \int_{c.v.} \mathbf{g} \cdot \hat{k} \rho dV + \underbrace{\int_{c.v.} \mathbf{P} \cos \theta_z dA + \int_{c.v.} \boldsymbol{\tau}_z dA}_{\substack{\text{liquid surface} \\ \text{forces on} \\ \text{the nozzle} \\ F_{nozzle}}} = \underbrace{\int_{c.v.} \rho \mathbf{U}_z dV + \int_{c.v.} \rho \mathbf{U}_z \cdot \mathbf{U}_{rn} dA}_{\substack{\text{solid} \\ \text{surface}}} \tag{6.III.b}$$

All the forces that act on the nozzle are combined as

$$\sum F_{nozzle} + \int_{c.v.} \mathbf{g} \cdot \hat{k} \rho dV + \int_{c.v.} \mathbf{P} \cos \theta_z dA = \int_{c.v.} \rho \mathbf{U}_z \cdot \mathbf{U}_{rn} dA \quad (6.III.c)$$

The second term or the body force which acts through the center of the nozzle is

$$\mathbf{F}_b = - \int_{c.v.} \mathbf{g} \cdot \hat{n} \rho dV = -g \rho V_{nozzle}$$

Notice that in the results the gravity is not bold since only the magnitude is used. The part of the pressure which act on the nozzle in the  $z$  direction is

$$- \int_{c.v.} P dA = \int_1 P dA - \int_2 P dA = PA|_1 - PA|_2$$

The last term in equation (6.III.c) is

$$\int_{c.v.} \rho \mathbf{U}_z \cdot \mathbf{U}_{rn} dA = \int_{A_2} U_2 (U_2) dA - \int_{A_1} U_1 (U_1) dA$$

which results in

$$\int_{c.v.} \rho \mathbf{U}_z \cdot \mathbf{U}_{rn} dA = \rho (U_2^2 A_2 - U_1^2 A_1)$$

Combining all transform equation (6.III.c) into

$$F_z = -g \rho V_{nozzle} + PA|_2 - PA|_1 + \rho (U_2^2 A_2 - U_1^2 A_1) \quad (6.III.d)$$

$$F_z = 9.8 \times 1000 \times$$

---

End Solution

## 6.2 Momentum Equation Application

### Momentum Equation Applied to Propellers

The propeller is a mechanical devise that is used to increase the fluid momentum. Many times it is used for propulsion purposes of airplanes, ships and other devices (thrust) as shown in Figure 6.4. The propeller can be stationary like in cooling tours, fan etc. The other common used of propeller is mostly to move fluids as a pump.

The propeller analysis of unsteady is complicated due to the difficulty in understanding the velocity field. For a steady state the analysis is simpler and used here to provide an example of steady state. In the Figure 6.4 the fluid flows from the left to the right. Either it is assumed that some of the fluid enters into the container and fluid outside is not affected by the propeller. Or there is a line (or surface) in which the fluid outside changes only the flow direction. This surface is called slip surface. Of course it is only approximation but is provided a crude tool. Improvements can be made to this analysis. Here, this analysis is used for academic purposes.

As first approximation, the pressure around control volume is the same. Thus, pressure drops from the calculation. The one dimensional momentum equation is reduced

$$F = \rho (U_2^2 - U_1^2) \quad (6.19)$$

Combining the control volume between points 1 and 3 with (note that there are no external forces) with points 4 and 2 results in

$$\rho (U_2^2 - U_1^2) = P_4 - P_3 \quad (6.20)$$

This analysis provide way to calculate the work needed to move this propeller. Note that in this analysis it was assumed that the flow is horizontal that  $z_1 = z_2$  and/or the change is insignificant.

**Jet Propulsion**

Jet propulsion is a mechanism in which the air planes and other devices are propelled. Essentially, the air is sucked into engine and with addition heating (burning fuel) the velocity is increased. Further increase of the exit area with the increased of the burned gases further increase the thrust. The analysis of such device in complicated and there is a whole class dedicated for such topic in many universities. Here, a very limited discussion related to the steady state is offered.

The difference between the jets propulsion and propellers is based on the energy supplied. The propellers are moved by a mechanical work which is converted to thrust. In Jet propulsion, the thermal energy is converted to thrust. Hence, this direct conversion can be, and is, in many case more efficient. Furthermore, as it will be shown in the Chapter on compressible flow it allows to achieve velocity above speed of sound, a major obstacle in the past.

The inlet area and exit area are different for most jets and if the mass of the fuel is neglected then

$$F = \rho (A_2 U_2^2 - A_1 U_1^2) \quad (6.21)$$

An academic example to demonstrate how a steady state calculations are done for a moving control volume. Notice that

**Example 6.4:**

*A sled toy shown in Figure 6.5 is pushed by liquid jet. Calculate the friction force on the toy when the toy is at steady state with velocity,  $U_0$ . Assume that the jet is horizontal and the reflecting jet is vertical. The*

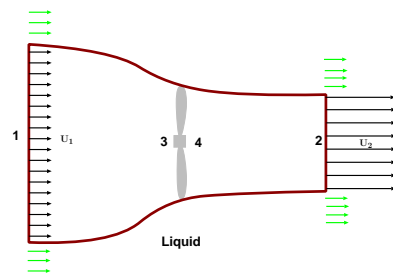

Fig. -6.4. Propeller schematic to explain the change of momentum due to velocity.

velocity of the jet is uniform. Neglect the friction between the liquid (jet) and the toy and between the air and toy. Calculate the absolute velocity of the jet exit. Assume that the friction between the toy and surface (ground) is relative to the vertical force. The dynamics friction is  $\mu_d$ .

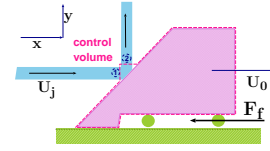

Fig. -6.5. Toy Sled pushed by the liquid jet in a steady state for example 6.4.

### SOLUTION

The chosen control volume is attached to the toy and thus steady state is obtained. The frame of reference is moving with the toy velocity,  $U_0$ . The applicable mass conservation equation for steady state is

$$A_1 U_1 = A_2 U_2$$

The momentum equation in the  $x$  direction is

$$\mathbf{F}_f + \int_{c.v.} \mathbf{g} \rho dV - \int_{c.v.} \mathbf{P} dA + \int_{c.v.} \boldsymbol{\tau} dA = \int_{c.v.} \rho \mathbf{U} \mathbf{U}_{rn} dV \quad (6.IV.a)$$

The relative velocity into the control volume is

$$\mathbf{U}_{1j} = (U_j - U_0) \hat{x}$$

The relative velocity out the control volume is

$$\mathbf{U}_{2j} = (U_j - U_0) \hat{y}$$

The absolute exit velocity is

$$\mathbf{U}_2 = U_0 \hat{x} + (U_j - U_0) \hat{y}$$

For small volume, the gravity can be neglected also because this term is small compared to other terms, thus

$$\int_{c.v.} \mathbf{g} \rho dV \sim 0$$

The same can be said for air friction as

$$\int_{c.v.} \boldsymbol{\tau} dA \sim 0$$

The pressure is uniform around the control volume and thus the integral is

$$\int_{c.v.} \mathbf{P} dA = 0$$

The control volume was chosen so that the pressure calculation is minimized.

The momentum flux is

$$\int_{S_{c.v.}} \rho U_x U_i r n dA = A \rho U_{1j}^2 \quad (6.IV.b)$$

The substituting (6.IV.b) into equation (6.IV.a) yields

$$F_f = A \rho U_{1j}^2 \quad (6.IV.c)$$

The friction can be obtained from the momentum equation in the  $y$  direction

$$m_{toy} g + A \rho U_{1j}^2 = F_{earth}$$

According to the statement of question the friction force is

$$F_f = \mu_d (m_{toy} g + A \rho U_{1j}^2)$$

The momentum in the  $x$  direction becomes

$$\mu_d (m_{toy} g + A \rho U_{1j}^2) = A \rho U_{1j}^2 = A \rho (U_j - U_0)^2$$

The toy velocity is then

$$U_0 = U_j - \sqrt{\frac{\mu_d m_{toy} g}{A \rho (1 - \mu_d)}}$$

Increase of the friction reduce the velocity. Additionally larger toy mass decrease the velocity.

---

End Solution

---

### 6.2.1 Momentum for Unsteady State and Uniform Flow

The main problem in solving the unsteady state situation is that the control volume is accelerating. A possible way to solve the problem is by expressing the terms in an equation (6.10). This method is cumbersome in many cases. Alternative method of solution is done by attaching the frame of reference to the accelerating body. One such example of such idea is associated with the Rocket Mechanics which is present here.

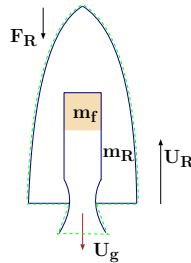

Fig. -6.6. A rocket with a moving control volume.

### 6.2.2 Momentum Application to Unsteady State

#### Rocket Mechanics

A rocket is a device similar to jet propulsion. The difference is the fact that the oxidant is on board with the fuel. The two components are burned and the gases are ejected through a nozzle. This mechanism is useful for specific locations because it is independent of the medium through which it travels. In contrast to other mechanisms such as jet propulsion which obtain the oxygen from the medium through which they travel the rockets carry the oxygen with it. The rocket is accelerating and thus the frame of reference is moving with the rocket. The velocity of the rocket in the rocket frame of reference is zero. However, the derivative with respect to time,  $d\mathbf{U}/dt \neq 0$  is not zero. The resistance of the medium is denoted as  $F_R$ . The momentum equation is

$$\underbrace{\int_{c.v.} \tau dA}_{F_R} + \int_{c.v.} \mathbf{g} \rho dV + \underbrace{\int_{c.v.} \mathbf{P} dA}_0 - \int_{c.v.} \rho a_0 dV = \frac{d}{dt} \int_{V_{c.v.}} \rho U_y dV + \int_{c.v.} \rho U_y U_{rn} dA \quad (6.22)$$

There are no external forces in this control volume thus, the first term  $F_R$ , vanishes. The pressure term vanishes because the pressure essentially is the same and the difference can be neglected. The gravity term is an instantaneous mass times the gravity times the constant and the same can be said for the acceleration term. Yet, the acceleration is the derivative of the velocity and thus

$$\int \rho a_0 dV = \frac{dU}{dt} (m_R + m_f) \quad (6.23)$$

The first term on the right hand side is the change of the momentum in the rocket volume. This change is due to the change in the volume of the oxidant and the fuel.

$$\frac{d}{dt} \int_{V_{c.v.}} \rho U_y dV = \frac{d}{dt} [(m_R + m_f) U] \quad (6.24)$$

Clearly, the change of the rocket mass can be considered minimal or even neglected. The oxidant and fuel flow outside. However, inside the rocket the change in the velocity is due to change in the reduction of the volume of the oxidant and fuel. This change is minimal and for this analysis, it can be neglected. The last term is

$$\int_{c.v.} \rho U_y U_{rn} dA = \dot{m} (U_g - U_R) \quad (6.25)$$

Combining all the above terms results in

$$-F_R - (m_R + m_f) g + \frac{dU}{dt} (m_R + m_f) = \dot{m} (U_g - U_R) \quad (6.26)$$

Denoting  $\mathcal{M}_T = m_R + m_f$  and thus  $d\mathcal{M}_T/dt = \dot{m}$  and  $U_e = U_g - U_R$ . As first approximation, for constant fuel consumption (and almost oxidant), gas flow out is constant as well. Thus, for constant gas consumption equation (6.26) transformed to

$$-F_R - \mathcal{M}_T g + \frac{dU}{dt} \mathcal{M}_T = \dot{\mathcal{M}}_T U_e \quad (6.27)$$

Separating the variables equation (6.27) yields

$$dU = \left( \frac{-\dot{\mathcal{M}}_T U_e}{\mathcal{M}_T} - \frac{F_R}{\mathcal{M}_T} - g \right) dt \quad (6.28)$$

Before integrating equation (6.28), it can be noticed that the friction resistance  $F_R$ , is a function of the several parameters such the duration, the speed (the Reynolds number), material that surface made and the medium it flow in altitude. For simplicity here the part close to Earth (to the atmosphere) is assumed to be small compared to the distance in space. Thus it is assume that  $F_R = 0$ . Integrating equation (6.28) with limits of  $U(t = 0) = 0$  provides

$$\int_0^U dU = -\dot{\mathcal{M}}_T U_e \int_0^t \frac{dt}{\mathcal{M}_T} - \int_0^t g dt \quad (6.29)$$

the results of the integration is (notice  $\mathcal{M} = \mathcal{M}_0 - t\dot{\mathcal{M}}$ )

$$U = U_e \ln \left( \frac{\mathcal{M}_0}{\mathcal{M}_0 - t\dot{\mathcal{M}}} \right) - g t \quad (6.30)$$

The following is an elaborated example which deals with an unsteady two dimensional problem. This problem demonstrates the used of control volume to find method of approximation for not given velocity profiles<sup>1</sup>

Example 6.5:

A tank with wheels is filled with liquid is depicted in Figure 6.7. The tank upper part is opened to the atmosphere. At initial time the valve on the tank is opened and the liquid flows out with an uniform velocity profile. The tank mass with the wheels (the solid parts) is known,  $m_t$ . Calculate the tank velocity for two cases. One the wheels have a constant resistance with the ground and two the resistance linear function of the weight. Assume that the exit velocity is a linear function of the height.

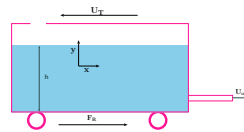

Fig. -6.7. Schematic of a tank seating on wheel for unsteady state discussion

### SOLUTION

This problem is similar to the rocket mechanics with a twist, the source of the propulsion is the potential energy. Furthermore, the fluid has two velocity components verse one

<sup>1</sup>A variation of this problem has appeared in many books in the literature. However, in the past it was not noticed that a slight change in configuration leads to a constant  $x$  velocity. This problem was aroused in manufacturing industry. This author was called for consultation and to solve a related problem. For which he noticed this "constant velocity."

component in the rocket mechanics. The control volume is shown in Figure 6.7. The frame of reference is moving with the tank. This situation is unsteady state thus equation (6.12) for two dimensions is used. The mass conservation equation is

$$\frac{d}{dt} \int_{V_{c.v.}} \rho dV + \int_{S_{c.v.}} \rho dA = 0 \quad (6.V.a)$$

Equation (6.V.a) can be transferred to

$$\frac{dm_{c.v.}}{dt} = -\rho U_0 A_0 = -m_0 \quad (6.V.b)$$

Where  $m_0$  is mass flow rate out. Equation (6.V.b) can be further reduced due to constant density to

$$\frac{d(Ah)}{dt} + U_0 A_0 = 0 \quad (6.V.c)$$

It can be noticed that the area of the tank is almost constant ( $A = \text{constant}$ ) thus

$$A \frac{dh}{dt} + U_0 A_0 = 0 \implies \frac{dh}{dt} = -\frac{U_0 A_0}{A} \quad (6.31)$$

The relationship between the height and the flow now can be used.

$$U_0 = \mathcal{B} h \quad (6.V.d)$$

Where  $\mathcal{B}$  is the coefficient that has the right units to match equation (6.V.d) that represent the resistance in the system and substitute the energy equation. Substituting equation (6.V.d) into equation (6.V.c) results in

$$\frac{dh}{dt} + \frac{\mathcal{B} h A_0}{A} = 0 \quad (6.V.e)$$

Equation (6.V.e) is a first order differential equation which can be solved with the initial condition  $h(t = 0) = h_0$ . The solution (see for details in the Appendix A.2.1 ) is

$$h(t) = h_0 e^{-\frac{t A_0 \mathcal{B}}{A}} \quad (6.V.f)$$

To find the average velocity in the  $x$  direction a new control volume is used. The boundary of this control volume are the tank boundary on the left with the straight surface as depicted in Figure 6.8. The last boundary is variable surface in a distance  $x$  from the tank left part. The tank depth, is not relevant. The mass conservation for this control volume is

$$\rho x \frac{dh}{dt} = -\rho h \bar{U}_x \quad (6.V.g)$$

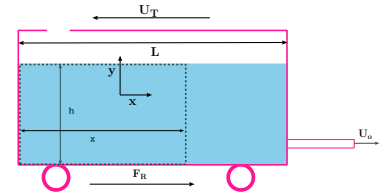

Fig. -6.8. A new control volume to find the velocity in discharge tank for example 6.5.



Where here  $w$  is the depth or width of the tank. Substituting (6.V.f) into (6.V.g) results

$$\overline{U}_x(x) = \frac{x A_0 \cancel{h_0} \mathcal{B}}{A \cancel{h}} e^{-\frac{t A_0 \mathcal{B}}{A}} = \frac{x A_0 \mathcal{B}}{A} \quad (6.V.h)$$

The average  $x$  component of the velocity is a linear function of  $x$ . Perhaps surprising, it also can be noticed that  $\overline{U}_x(x)$  is a not function of the time. Using this function, the average velocity in the tank is

$$\overline{U}_x = \frac{1}{L} \int_0^L \frac{x A_0 \mathcal{B}}{A} = \frac{L A_0 \mathcal{B}}{2 A} \quad (6.V.i)$$

It can be noticed that  $\overline{U}_x$  is not function of height,  $h$ . In fact, it can be shown that average velocity is a function of cross section (what direction?).

Using a similar control volume<sup>2</sup>, the average velocity in the  $y$  direction is

$$\overline{U}_y = \frac{dh}{dt} = -\frac{h_0 A_0 \mathcal{B}}{A} e^{-\frac{t A_0 \mathcal{B}}{A}} \quad (6.V.j)$$

It can be noticed that the velocity in the  $y$  is a function of time as oppose to the  $x$  direction.

The applicable momentum equation (in the tank frame of reference) is (6.11) which is reduced to

$$-\mathbf{F}_R - (m_t + m_f) \mathbf{g} - \overbrace{\mathbf{a} (m_t + m_f)}^{\text{acceleration}} = \frac{d}{dt} [(m_t + m_f) \mathbf{U}_r] + U_0 m_o \quad (6.V.k)$$

Where  $\mathbf{U}_r$  is the relative fluid velocity to the tank (if there was no tank movement).  $m_f$  and  $m_t$  are the mass of the fluid and the mass of tank respectively. The acceleration of the tank is  $\mathbf{a} = -\hat{i} a_0$  or  $\hat{i} \cdot \mathbf{a} = -a$ . And the additional force for accelerated system is

$$-\hat{i} \cdot \int_{V_{c.v.}} \mathbf{a} \rho dV = m_{c.v.} a$$

The mass in the control volume include the mass of the liquid with mass of the solid part (including the wheels).

$$m_{c.v.} = m_f + m_T$$

because the density of the air is very small the change of the air mass is very small as well ( $\rho_a \ll \rho$ ).

The pressure around the control volume is uniform thus

$$\int_{S_{c.v.}} P \cos \theta_x dA \sim 0$$

<sup>2</sup>The boundaries are the upper (free surface) and tank side with a  $y$  distance from the free surface.  $\int U_{bn} dA = \int U_{rn} dA \implies U_{bn} = U_{rn}$ .

and the resistance due to air is negligible, hence

$$\int_{S_{c.v.}} \tau dA \sim 0$$

The momentum flow rate out of the tank is

$$\int_{S_{c.v.}} \rho U_x U_{rn} dA = \rho U_o^2 A_o = m_o U_o \quad (6.32)$$

In the  $x$  coordinate the momentum equation is

$$-F_x + (m_t + m_f) a = \frac{d}{dt} [(m_t + m_f) U_x] + U_o \dot{m}_f \quad (6.V.l)$$

Where  $F_x$  is the  $x$  component of the reaction which is opposite to the movement direction. The momentum equation in the  $y$  coordinate it is

$$F_y - (m_t + m_f) g = \frac{d}{dt} [(m_t + m_f) U_y] \quad (6.V.m)$$

There is no mass flow in the  $y$  direction and  $U_y$  is component of the velocity in the  $y$  direction.

The tank movement cause movement of the air which cause momentum change. This momentum is function of the tank volume times the air density times tank velocity ( $h_o \times A \times \rho_a \times U$ ). This effect is known as the add mass/momentum and will be discussed in the Dimensional Analysis and Ideal Flow Chapters. Here this effect is neglected.

The main problem of integral analysis approach is that it does not provide a way to analysis the time derivative since the velocity profile is not given inside the control volume. This limitation can be partially overcome by assuming some kind of average. It can be noticed that the velocity in the tank has two components. The first component is downward ( $y$ ) direction and the second in the exit direction ( $x$ ). The velocity in the  $y$  direction does not contribute to the momentum in the  $x$  direction. The average velocity in the tank (because constant density and more about it later section) is

$$\bar{U}_x = \frac{1}{V_t} \int_{V_f} U_x dV$$

Because the integral is replaced by the average it is transferred to

$$\int_{V_f} \rho U_x dV \sim m_{c.v.} \bar{U}_x$$

Thus, if the difference between the actual and averaged momentum is neglected then

$$\frac{d}{dt} \int_{V_f} \rho U_x dV \sim \frac{d}{dt} (m_{c.v.} \bar{U}_x) = \frac{d m_{c.v.}}{dt} \bar{U}_x + \overbrace{\frac{d \bar{U}_x}{dt}}^{\sim 0} m_{c.v.} \quad (6.V.n)$$

Noticing that the derivative with time of control volume mass is the flow out in equation (6.V.n) becomes

$$\frac{d m_{c.v.} \bar{U}_x}{dt} + \frac{d \bar{U}_x}{dt} m_{c.v.} = - \overbrace{\dot{m}_0}^{\substack{\text{mass} \\ \text{rate} \\ \text{out}}} \bar{U}_x = -m_0 \frac{L A_0 \mathcal{B}}{2 A} \quad (6.V.o)$$

Combining all the terms results in

$$-F_x + a (m_f + m_t) = -m_0 \frac{L A_0 \mathcal{B}}{2 A} - U_0 m_0 \quad (6.V.p)$$

Rearranging and noticing that  $a = dU_T/dt$  transformed equation (6.V.p) into

$$a = \frac{F_x}{m_f + m_t} - m_0 \left( \frac{L A_0 \mathcal{B} + 2 A U_0 (m_f + m_t)}{2 A (m_f + m_t)} \right) \quad (6.V.q)$$

If the  $F_x \geq m_0 \left( \frac{L A_0 \mathcal{B}}{2 A} + U_0 \right)$  the toy will not move. However, if it is the opposite the toy start to move. From equation (6.V.d) the mass flow out is

$$m_0(t) = \mathcal{B} h_0 \overbrace{e^{-\frac{U_0}{h} \frac{t A_0 \mathcal{B}}{A}}}^{\substack{U_0 \\ h}} A_0 \rho \quad (6.V.r)$$

The mass in the control volume is

$$m_f = \rho A h_0 \overbrace{e^{-\frac{V}{h} \frac{t A_0 \mathcal{B}}{A}}}^{\substack{V \\ h}} \quad (6.V.s)$$

The initial condition is that  $U_T(t = 0) = 0$ . Substituting equations (6.V.r) and (6.V.s) into equation (6.V.q) transforms it to a differential equation which is integrated if  $R_x$  is constant.

For the second case where  $R_x$  is a function of the  $R_y$  as

$$R_x = \mu R_y \quad (6.33)$$

The  $y$  component of the average velocity is function of the time. The change in the accumulative momentum is

$$\frac{d}{dt} [(m_f) \bar{U}_y] = \frac{d m_f}{dt} \bar{U}_y + \frac{d \bar{U}_y}{dt} m_f \quad (6.V.t)$$

The reason that  $m_f$  is used because the solid parts do not have velocity in the  $y$  direction. Rearranging the momentum equation in the  $y$  direction transformed

$$F_y = \left( \overbrace{m_t + \rho A h_0 e^{-\frac{m_f}{h} \frac{t A_0 \mathcal{B}}{A}}}^{\substack{m_f \\ h}} \right) g + 2 \left( \frac{\rho h_0 A_0^2 \mathcal{B}^2}{A} \right)^2 e^{-\frac{t A_0 \mathcal{B}}{A}} \quad (6.V.u)$$

The actual results of the integrations are not provided since the main purpose of this exercise is to learn how to use the integral analysis.

---

End Solution

---

### Averaged Velocity! Estimates

In example 6.1 relationship between momentum of maximum velocity to average velocity was presented. Here, relationship between momentum for the average velocity to the actual velocity is presented. There are situations where actual velocity profile is not known but its function can be approximated. For example, the velocity profile can be estimated using the ideal fluid theory but the actual values are not known. For example, the flow profile in example 6.5 can be estimated even by hand sketching.

For these cases a correction factor can be used. This correction factor can be calculated by finding the relation between the two cases. The momentum for average velocity is

$$M_a = m_{c.v} \bar{U} = \rho V \int_{c.v} U dV \quad (6.34)$$

The actual momentum for control volume is

$$M_c = \int_{c.v.} \rho U_x dV \quad (6.35)$$

These two have to equal thus,

$$C \rho V \int_{c.v} U dV = \int_{c.v.} \rho U_x dV \quad (6.36)$$

If the density is constant then the coefficient is one ( $C \equiv 1$ ). However, if the density is not constant, the coefficient is not equal to one.

### 6.3 Conservation Moment Of Momentum

The angular momentum can be derived in the same manner as the momentum equation for control volume. The force

$$\mathbf{F} = \frac{D}{Dt} \int_{V_{sys}} \rho \mathbf{U} dV \quad (6.37)$$

The angular momentum then will be obtained by calculating the change of every element in the system as

$$\mathfrak{M} = \mathbf{r} \times \mathbf{F} = \frac{D}{Dt} \int_{V_{sys}} \rho \mathbf{r} \times \mathbf{U} dV \quad (6.38)$$

Now the left hand side has to be transformed into the control volume as

$$\mathfrak{M} = \frac{d}{dt} \int_{V_{c.v.}} \rho (\mathbf{r} \times \mathbf{U}) dV + \int_{S_{c.v}} \rho (\mathbf{r} \times \mathbf{U}) \mathbf{U}_{rn} dA \quad (6.39)$$

The angular momentum equation, applying equation (6.39) to uniform and steady state flow with neglected pressure gradient is reduced to

$$\mathfrak{M} = \dot{m} (r_2 \times U_2 + r_2 \times U_1) \quad (6.40)$$

### Introduction to Turbo Machinery

The analysis of many turbomachinery such as centrifugal pump is fundamentally based on the angular momentum. To demonstrate this idea, the following discussion is provided. A pump impeller is shown in Figure 6.9 commonly used in industry. The impeller increases the velocity of the fluid by increasing the radius of the particles. The inside particle is obtained larger velocity and due to centrifugal forces is moving to outer radius for which additionally increase of velocity occur. The pressure on the outer side is uniform thus does not create a moment. The flow is assumed to enter the impeller radially with average velocity  $U_1$ . Here it is assumed that fluid is incompressible ( $\rho = \text{constant}$ ). The height of the impeller is  $h$ . The exit liquid velocity,  $U_2$  has two components, one the tangential velocity,  $U_{t2}$  and radial component,  $U_{n2}$ . The relative exit velocity is  $U_{lr2}$  and the velocity of the impeller edge is  $U_{m2}$ . Notice that tangential liquid velocity,  $U_{t2}$  is not equal to the impeller outer edge velocity  $U_{m2}$ . It is assumed that required torque is function  $U_2$ ,  $r$ , and  $h$ .

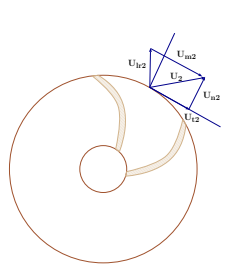

Fig. -6.9. The impeller of the centrifugal pump and the velocities diagram at the exit.

$$\mathfrak{M} = \dot{m} r_2 U_{t2} \quad (6.41)$$

Multiplying equation (6.41) results in

$$\mathfrak{M} \omega = \dot{m} \overbrace{r_2 \omega}^{U_{m2}} U_{t2} \quad (6.42)$$

The shaft work is given by the left side and hence,

$$\dot{W} = \dot{m} U_{m2} U_{t2} \quad (6.43)$$

The difference between  $U_{m2}$  to  $U_{t2}$  is related to the efficiency of the pump which will be discussed in the chapter on the turbomachinery.

#### Example 6.6:

A centrifugal pump is pumping  $600 \text{ [m}^3/\text{hour}]$ . The thickness of the impeller,  $h$  is  $2 \text{ [cm]}$  and the exit diameter is  $0.40 \text{ [m]}$ . The angular velocity is  $1200 \text{ r.p.m.}$  Assume that angle velocity is leaving the impeller is  $125^\circ$ . Estimate what is the minimum energy required by the pump.

## 6.4 More Examples on Momentum Conservation

### Example 6.7:

A design of a rocket is based on the idea that density increase of the leaving jet increases the acceleration of the rocket see Figure

6.10. Assume that this idea has a good engineering logic. Liquid fills the lower part of the rocket tank. The upper part of the rocket tank is filled with compressed gas. Select the control volume in such a way that provides the ability to find the rocket acceleration. What is the instantaneous velocity of the rocket at time zero? Develop the expression for the pressure (assuming no friction with the walls). Develop expression for rocket velocity. Assume that the gas is obeying the perfect gas model. What are the parameters that effect the problem.

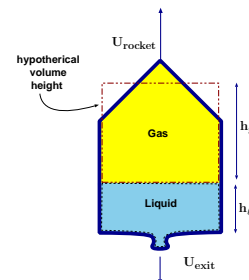

Fig. -6.10. Nozzle schematics water rocket for the discussion on the forces for example 6.7

### SOLUTION

#### Under construction for time being only hints<sup>3</sup>

In the solution of this problem several assumptions must be made so that the integral system can be employed.

- The surface remained straight at the times and no liquid residue remains behind.
- The gas obeys the ideal gas law.
- The process is isothermal (can be isentropic process).
- No gas leaves the rocket.
- The mixing between the liquid and gas is negligible.
- The gas mass is negligible in comparison to the liquid mass and/or the rocket.
- No resistance to the rocket (can be added).
- The cross section of the liquid is constant.

In this problem the energy source is the pressure of the gas which propels the rocket. Once the gas pressure reduced to be equal or below the outside pressure the

<sup>3</sup>This problem appeared in the previous version (0.2.3) without a solution. Several people ask to provide a solution or some hints for the solution. The following is not the solution but rather the approach how to treat this problem.

rocket have no power for propulsion. Additionally, the initial take off is requires a larger pressure.

The mass conservation is similar to the rocket hence it is

$$\frac{dm}{dt} = -U_e A_e \quad (6.VII.a)$$

The mass conservation on the gas zone is a byproduct of the mass conservation of the liquid. Furthermore, it can be observed that the gas pressure is a direct function of the mass flow out.

The gas pressure at the initial point is

$$P_0 = \rho_0 R T \quad (6.VII.b)$$

Per the assumption the gas mass remain constant and is denoted as  $m_g$ . Using the above definition, equation (6.VII.b) becomes

$$P_0 = \frac{m_g R T}{V_{0g}} \quad (6.VII.c)$$

The relationship between the gas volume

$$V_g = \bar{h}_g A \quad (6.VII.d)$$

The gas geometry is replaced by a virtual constant cross section which cross section of the liquid (probably the same as the base of the gas phase). The change of the gas volume is

$$\frac{dV_g}{dt} = A \frac{dh_g}{dt} = -A \frac{dh_\ell}{dt} \quad (6.VII.e)$$

The last identify in the above equation is based on the idea what ever height concede by the liquid is taken by the gas. The minus sign is to account for change of "direction" of the liquid height. The total change of the gas volume can be obtained by integration as

$$V_g = A (h_{g0} - \Delta h_\ell) \quad (6.VII.f)$$

It must be point out that integral is not function of time since the height as function of time is known at this stage.

The initial pressure now can be expressed as

$$P_0 = \frac{m_g R T}{h_{g0} A} \quad (6.VII.g)$$

The pressure at any time is

$$P = \frac{m_g R T}{h_g A} \quad (6.VII.h)$$

Thus the pressure ratio is

$$\frac{P}{P_0} = \frac{h_{g0}}{h_g} = \frac{h_{g0}}{h_{g0} - \Delta h_\ell} = h_{g0} \frac{1}{1 - \frac{\Delta h_\ell}{h_{g0}}} \quad (6.VII.i)$$

Equation (6.VII.a) can be written as

$$m_\ell(t) = m_{\ell 0} - \int_0^t U_e A_e dt \quad (6.VII.j)$$

From equation (6.VII.a) it also can be written that

$$\frac{dh_\ell}{dt} = \frac{U_e A_e}{\rho_e A} \quad (6.VII.k)$$

According to the assumption the flow out is linear function of the pressure inside thus,

$$U_e = f(P) + g h_\ell \rho_e \simeq f(P) = \zeta P \quad (6.VII.l)$$

Where  $\zeta$  here is a constant which the right units.

The liquid momentum balance is

$$-g(m_R + m_\ell) - a(m_R + m_\ell) = \overbrace{\frac{d}{dt}(m_R + m_\ell)U}^{=0} + bc + (U_R + U_\ell)m_\ell \quad (6.VII.m)$$

Where  $bc$  is the change of the liquid mass due the boundary movement.

---

End Solution

---

**Example 6.8:**

*A rocket is filled with only compressed gas. At a specific moment the valve is opened and the rocket is allowed to fly. What is the minimum pressure which make the rocket fly. What are the parameters that effect the rocket velocity. Develop an expression for the rocket velocity.*

**Example 6.9:**

*In Example 6.5 it was mentioned that there are only two velocity components. What was the assumption that the third velocity component was neglected.*

### 6.4.1 Qualitative Questions

**Example 6.10:**

*For each following figures discuss and state force direction and the momentum that act on the control volume due to .*

**Example 6.11:**



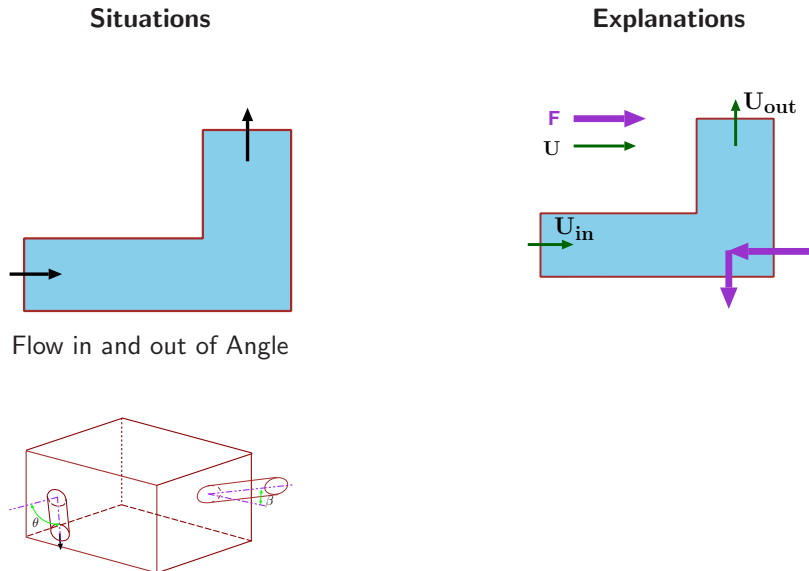

Flow in and out at angle from a tank

A similar tank as shown in Figure 6.11 is built with a exit located in uneven distance from the the right and the left and is filled with liquid. The exit is located on the left hand side at the front. What are the direction of the forces that keep the control volume in the same location? Hints, consider the unsteady effects. Look at the directions which the unsteady state momentum in the tank change its value.

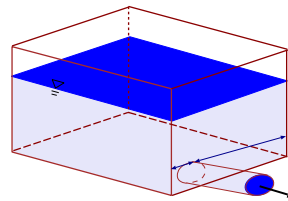

Fig. -6.11. Flow out of un symmetrical tank for example 6.11

**Example 6.12:**

A large tank has opening with area,  $A$ . In front and against the opening there a block with mass of  $50[\text{kg}]$ . The friction factor between the block and surface is  $0.5$ . Assume that resistance between the air and the water jet is negligible. Calculated the minimum height of the liquid in the tank in order to start to have the block moving?

SOLUTION

The solution of this kind problem first requires to know at what accuracy this solution is needed. For great accuracy, the effect minor loss or the loss in the tank opening have taken into account. First assuming that a minimum accuracy therefore the information was given on the tank that it large. First, the velocity to move the block can be obtained from the analysis of the block free body diagram (the impinging jet diagram).

The control volume is attached to the block. It is assumed that the two streams in the vertical cancel each other. The jet stream has only one component in the horizontal component. Hence,

$$F = \rho A U_{exit}^2 \quad (6.XII.a)$$

The minimum force the push the block is

$$\rho A U_{exit}^2 = m g \mu \implies U_{exit} = \sqrt{\frac{m g \mu}{\rho A}} \quad (6.XII.b)$$

And the velocity as a function of the height is  $U = \sqrt{\rho g h}$  and thus

$$h = \frac{m \mu}{\rho^2 A} \quad (6.XII.c)$$

It is interesting to point out that the gravity is relevant. That is the gravity has no effect on the velocity (height) required to move the block. However, if the gravity was in the opposite direction, no matter what the height will be the block will not move (neglecting other minor effects). So, the gravity has effect and the effect is the direction, that is the same height will be required on the moon as the earth.

For very tall blocks, the forces that acts on the block in the vertical direction is can be obtained from the analysis of the control volume shown in Figure 6.12. The jet impinged on the surface results in out flow stream going to all the directions in the block surface. Yet, the gravity acts on all these "streams" and eventually the liquid flows downwards. In fact because the gravity the jet impinging in downwards sled direction. At the extreme case, all liquid flows downwards. The balance on the stream downwards (for steady state) is

$$\rho \overline{U_{out}}^2 \cong \rho V_{liquid} g + m g \quad (6.XII.d)$$

Where  $V_{liquid}$  is the liquid volume in the control volume (attached to the block). The pressure is canceled because the flow is exposed to air. In cases were  $\rho V_{liquid} g > \rho \overline{U_{out}}^2$  the required height is larger. In the opposite cases the height is smaller.

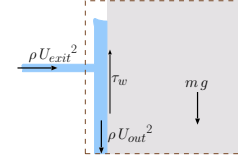

Fig. -6.12. Jet impinging jet surface perpendicular and with the surface.

---

---

# CHAPTER 7

---

## Energy Conservation

### 7.1 *The First Law of Thermodynamics*

This chapter focuses on the energy conservation which is the first law of thermodynamics<sup>1</sup>. The fluid, as all phases and materials, obeys this law which creates strange and wonderful phenomena such as a shock and choked flow. Moreover, this law allows to solve problems, which were assumed in the previous chapters. For example, the relationship between height and flow rate was assumed previously, here it will be derived. Additionally a discussion on various energy approximation is presented.

It was shown in Chapter 2 that the energy rate equation (2.10) for a system is

$$\dot{Q} - \dot{W} = \frac{D E_U}{Dt} + \frac{D (m U^2)}{Dt} + \frac{D (m g z)}{Dt} \quad (7.1)$$

This equation can be rearranged to be

$$\dot{Q} - \dot{W} = \frac{D}{Dt} \left( E_U + m \frac{U^2}{2} + m g z \right) \quad (7.2)$$

Equation (7.2) is similar to equation (6.3) in which the right hand side has to be interpreted and the left hand side interpolated using the Reynold's Transport Theorem (RTT)<sup>2</sup>. The right hand side is very complicated and only some of the effects will be discussed (It is only an introductory material).

---

<sup>1</sup>Thermodynamics is the favorite topic of this author since it was his major in high school. Clearly this topic is very important and will be extensively discussed here. However, during time of the constructing this book only a simple skeleton by Potto standards will be build.

<sup>2</sup>Some view the right hand side as external effects while the left side of the equation represents the internal effects. This simplistic representation is correct only under extreme conditions. For example, the above view is wrong when the heat convection, which is external force, is included on the right hand side.

The energy transfer is carried (mostly<sup>3</sup>) by heat transfer to the system or the control volume. There are three modes of heat transfer, conduction, convection<sup>4</sup> and radiation. In most problems, the radiation is minimal. Hence, the discussion here will be restricted to convection and conduction. Issues related to radiation are very complicated and considered advance material and hence will be left out. The issues of convection are mostly covered by the terms on the left hand side. The main heat transfer mode on the left hand side is conduction. Conduction for most simple cases is governed by Fourier's Law which is

$$d\dot{q} = k_T \frac{dT}{dn} dA \quad (7.3)$$

Where  $d\dot{q}$  is heat transfer to an infinitesimal small area per time and  $k_T$  is the heat conduction coefficient. The heat derivative is normalized into area direction. The total heat transfer to the control volume is

$$\dot{Q} = \int_{A_{cv}} k \frac{dT}{dn} dA \quad (7.4)$$

The work done on the system is more complicated to express than the heat transfer. There are two kinds of works that the system does on the surroundings. The first kind work is by the friction or the shear stress and the second by normal force. As in the previous chapter, the surface forces are divided into two categories: one perpendicular to the surface and one with the surface direction. The work done by system on the surroundings (see Figure 7.1) is

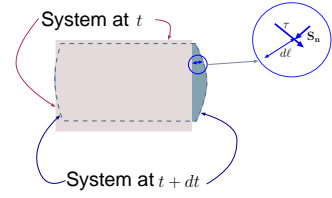

Fig. -7.1. The work on the control volume is done by two different mechanisms,  $S_n$  and  $\tau$ .

$$dw = -\overbrace{S dA}^{dF} \cdot dl = -(\mathbf{S}_n + \boldsymbol{\tau}) \cdot \overbrace{dl dA}^{dV} \quad (7.5)$$

The change of the work for an infinitesimal time (excluding the shaft work) is

$$\frac{dw}{dt} = -(\mathbf{S}_n + \boldsymbol{\tau}) \cdot \overbrace{\frac{dl}{dt}}^U dA = -(\mathbf{S}_n + \boldsymbol{\tau}) \cdot \mathbf{U} dA \quad (7.6)$$

The total work for the system including the shaft work is

$$\dot{W} = - \int_{Ac.v.} (\mathbf{S}_n + \boldsymbol{\tau}) \cdot \mathbf{U} dA - W_{shaft} \quad (7.7)$$

<sup>3</sup>There are other methods such as magnetic fields (like microwave) which are not part of this book.

<sup>4</sup>When dealing with convection, actual mass transfer must occur and thus no convection is possible to a system by the definition of system.

The energy equation (7.2) for system is

$$\int_{A_{sys}} k_T \frac{dT}{dn} dA + \int_{A_{sys}} (\mathbf{S}_n + \boldsymbol{\tau}) \cdot d\mathbf{V} + \dot{W}_{shaft} = \frac{D}{Dt} \int_{V_{sys}} \rho \left( E_U + m \frac{U^2}{2} + gz \right) dV \quad (7.8)$$

Equation (7.8) does not apply any restrictions on the system. The system can contain solid parts as well several different kinds of fluids. Now Reynolds Transport Theorem can be used to transformed the left hand side of equation (7.8) and thus yields

Energy Equation

$$\int_{A_{cv}} k_T \frac{dT}{dn} dA + \int_{A_{cv}} (\mathbf{S}_n + \boldsymbol{\tau}) \cdot d\mathbf{A} + \dot{W}_{shaft} = \frac{d}{dt} \int_{V_{cv}} \rho \left( E_u + m \frac{U^2}{2} + gz \right) dV + \int_{A_{cv}} \left( E_u + m \frac{U^2}{2} + gz \right) \rho U_{rn} dA \quad (7.9)$$

From now on the notation of the control volume and system will be dropped since all equations deals with the control volume. In the last term in equation (7.9) the velocity appears twice. Note that  $U$  is the velocity in the frame of reference while  $U_{rn}$  is the velocity relative to the boundary. As it was discussed in the previous chapter the normal stress component is replaced by the pressure (see equation (6.8) for more details). The work rate (excluding the shaft work) is

$$\dot{W} \cong \overbrace{\int_S P \hat{n} \cdot \mathbf{U} dA}^{\text{flow work}} - \int_S \boldsymbol{\tau} \cdot \mathbf{U} \hat{n} dA \quad (7.10)$$

The first term on the right hand side is referred to in the literature as the flow work and is

$$\int_S P \hat{n} \cdot \mathbf{U} dA = \int_S P \overbrace{(U - U_b) \hat{n}}^{U_{rn}} dA + \int_S P U_{bn} dA \quad (7.11)$$

Equation (7.11) can be further manipulated to become

$$\int_S P \hat{n} \cdot \mathbf{U} dA = \overbrace{\int_S \frac{P}{\rho} \rho U_{rn} dA}^{\text{work due to the flow}} + \overbrace{\int_S P U_{bn} dA}^{\text{work due to boundaries movement}} \quad (7.12)$$

The second term is referred to as the shear work and is defined as

$$\dot{W}_{shear} = - \int_S \boldsymbol{\tau} \cdot \mathbf{U} dA \quad (7.13)$$

Substituting all these terms into the governing equation yields

$$\begin{aligned} \dot{Q} - \dot{W}_{shear} - \dot{W}_{shaft} = & \frac{d}{dt} \int_V \left( E_u + \frac{U^2}{2} + gz \right) dV + \\ & \int_S \left( E_u + \frac{P}{\rho} + \frac{U^2}{2} + gz \right) U_{rn} \rho dA + \int_S P U_{rn} dA \end{aligned} \quad (7.14)$$

The new term  $P/\rho$  combined with the internal energy,  $E_u$  is referred to as the enthalpy,  $h$ , which was discussed on page 48. With these definitions equation (7.14) transformed

**Simplified Energy Equation**

$$\begin{aligned} \dot{Q} - \dot{W}_{shear} + \dot{W}_{shaft} = & \frac{d}{dt} \int_V \left( E_u + \frac{U^2}{2} + gz \right) \rho dV + \\ & \int_S \left( h + \frac{U^2}{2} + gz \right) U_{rn} \rho dA + \int_S P U_{bn} dA \end{aligned} \quad (7.15)$$

Equation (7.15) describes the energy conservation for the control volume in stationary coordinates. Also note that the shear work inside the the control volume considered as shaft work.

The example of flow from a tank or container is presented to demonstrate how to treat some of terms in equation (7.15).

### Flow Out From A Container

In the previous chapters of this book, the flow rate out of a tank or container was assumed to be a linear function of the height. The flow out is related to the height but in a more complicate function and is the focus of this discussion. The energy equation with mass conservation will be utilized for this analysis. In this analysis several assumptions are made which includes the following: constant density, the gas density is very small compared to liquid density, and exit area is relatively small, so the velocity can be assumed uniform (not a function of the opening height)<sup>5</sup>, surface tension effects are negligible and

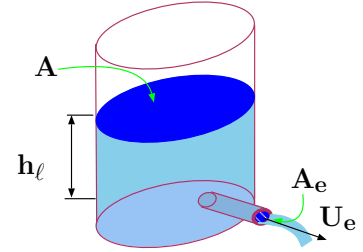

Fig. -7.2. Discharge from a Large Container with a small diameter.

<sup>5</sup>Later a discussion about the height opening effects will be discussed.

the liquid surface is straight<sup>6</sup>. Additionally, the temperature is assumed to constant. The control volume is chosen so that all the liquid is included up to exit of the pipe. The conservation of the mass is

$$\frac{d}{dt} \int_V \rho dV + \int_A \rho U_{rn} dA = 0 \quad (7.16)$$

which also can be written (because  $\frac{d\rho}{dt} = 0$ ) as

$$\int_A U_{bn} dA + \int_A U_{rn} dA = 0 \quad (7.17)$$

Equation (7.17) provides the relationship between boundary velocity to the exit velocity as

$$AU_b = A_e U_e \quad (7.18)$$

Note that the boundary velocity is not the averaged velocity but the actual velocity. The averaged velocity in  $z$  direction is same as the boundary velocity

$$U_b = U_z = \frac{dh}{dt} = \frac{A_e}{A} U_e \quad (7.19)$$

The  $x$  component of the averaged velocity is a function of the geometry and was calculated in Example 5.12 to be larger than

$$\overline{U}_x \gtrsim \frac{2r}{h} \frac{A_e}{A} U_e \implies \overline{U}_x \cong \frac{2r}{h} U_b = \frac{2r}{h} \frac{dh}{dt} \quad (7.20)$$

In this analysis, for simplicity, this quantity will be used.

The averaged velocity in the  $y$  direction is zero because the flow is symmetrical<sup>7</sup>. However, the change of the kinetic energy due to the change in the velocity field isn't zero. The kinetic energy of the tank or container is based on the half part as shown in Figure 7.3. Similar estimate that was done for  $x$  direction can be done to every side of the opening if they are not symmetrical. Since in this case the geometry is assumed to be symmetrical one side is sufficient as

$$\overline{U}_y \cong \frac{(\pi - 2)r}{8h} \frac{dh}{dt} \quad (7.21)$$

<sup>6</sup>This assumption is appropriated only under certain conditions which include the geometry of the tank or container and the liquid properties. A discussion about this issue will be presented in the Dimensional Chapter and is out of the scope of this chapter. Also note that the straight surface assumption is not the same surface tension effects zero.

Also notice that the surface velocity is not zero. The surface has three velocity components which non have them vanish. However, in this discussion it is assumed that surface has only one component in  $z$  direction. Hence it requires that velocity profile in  $x y$  to be parabolic. Second reason for this exercise the surface velocity has only one component is to avoid dealing with Bar-Meir's instability.

<sup>7</sup>For the mass conservation analysis, the velocity is zero for symmetrical geometry and some other geometries. However, for the energy analysis the averaged velocity cannot be considered zero.

The energy balance can be expressed by equation (7.15) which is applicable to this case. The temperature is constant<sup>8</sup>. In this light, the following approximation can be written

$$\dot{Q} = \frac{E_u}{dt} = h_{in} - h_{out} = 0 \quad (7.22)$$

The boundary shear work is zero because the velocity at tank boundary or walls is zero. Furthermore, the shear stresses at the exit are normal to the flow direction hence the shear work is vanished. At the free surface the velocity has only normal component<sup>9</sup> and thus shear work vanishes there as well. Additionally, the internal shear work is assumed negligible.

$$\dot{W}_{shear} = \dot{W}_{shaft} = 0 \quad (7.23)$$

Now the energy equation deals with no “external” effects. Note that the (exit) velocity on the upper surface is zero  $U_{rn} = 0$ .

Combining all these information results in

$$\underbrace{\frac{d}{dt} \int_V \left( \frac{U^2}{2} + gz \right) \rho dV}_{\text{internal energy change}} + \underbrace{\int_A \left( \frac{P_e}{\rho} + \frac{U_e^2}{2} \right) U_e \rho dA}_{\text{energy in and out}} - \underbrace{\int_A P_a U_b dA}_{\text{upper surface work}} = 0 \quad (7.24)$$

Where  $U_b$  is the upper boundary velocity,  $P_a$  is the external pressure and  $P_e$  is the exit pressure<sup>10</sup>.

The pressure terms in equation (7.24) are

$$\int_A \frac{P_e}{\rho} U_e \rho dA - \int_A P_a U_b dA = P_e \int_A U_e dA - P_a \int_A U_b dA \quad (7.25)$$

It can be noticed that  $P_a = P_e$  hence

$$P_a \overbrace{\left( \int_A U_e dA - \int_A U_b dA \right)}^{=0} = 0 \quad (7.26)$$

<sup>8</sup>This approach is a common approximation. Yet, why this approach is correct in most cases is not explained here. Clearly, the dissipation creates a loss that has temperature component. In this case, this change is a function of Eckert number,  $Ec$  which is very small. The dissipation can be neglected for small  $Ec$  number.  $Ec$  number is named after this author’s adviser, E.R.G. Eckert. A discussion about this effect will be presented in the dimensional analysis chapter. Some examples how to calculate these losses will be resent later on.

<sup>9</sup>It is only the same assumption discussed earlier.

<sup>10</sup>It is assumed that the pressure in exit across section is uniform and equal surroundings pressure.

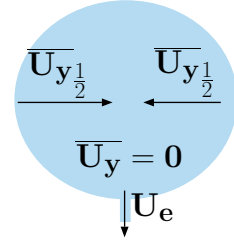

Fig. -7.3. How to compensate and estimate the kinetic energy when averaged Velocity is zero.



The governing equation (7.24) is reduced to

$$\frac{d}{dt} \int_V \left( \frac{U^2}{2} + gz \right) \rho dV - \int_A \left( \frac{U_e^2}{2} \right) U_e \rho dA = 0 \quad (7.27)$$

The minus sign is because the flow is out of the control volume.

Similarly to the previous chapter which the integral momentum will be replaced by some kind of average. The terms under the time derivative can be divided into two terms as

$$\frac{d}{dt} \int_V \left( \frac{U^2}{2} + gz \right) \rho dV = \frac{d}{dt} \int_V \frac{U^2}{2} dV + \frac{d}{dt} \int_V gz \rho dV \quad (7.28)$$

The second integral (in the r.h.s) of equation (7.28) is

$$\frac{d}{dt} \int_V gz \rho dV = g \rho \frac{d}{dt} \int_A \int_0^h z \overbrace{dz dA}^{dV} \quad (7.29)$$

Where  $h$  is the height or the distance from the surface to exit. The inside integral can be evaluated as

$$\int_0^h z dz = \frac{h^2}{2} \quad (7.30)$$

Substituting the results of equation (7.30) into equation (7.29) yields

$$g \rho \frac{d}{dt} \int_A \frac{h^2}{2} dA = g \rho \frac{d}{dt} \left( \frac{h}{2} \overbrace{h A}^V \right) = g \rho A h \frac{d h}{dt} \quad (7.31)$$

The kinetic energy related to the averaged velocity with a correction factor which depends on the geometry and the velocity profile. Furthermore, Even the averaged velocity is zero the kinetic energy is not zero and another method should be used.

A discussion on the correction factor is presented to provide a better “averaged” velocity. A comparison between the actual kinetic energy and the kinetic energy due to the “averaged” velocity (to be called the averaged kinetic energy) provides a correction coefficient. The first integral can be estimated by examining the velocity profile effects. The averaged velocity is

$$U_{ave} = \frac{1}{V} \int_V U dV \quad (7.32)$$

The total kinetic energy for the averaged velocity is

$$\rho U_{ave}^2 V = \rho \left( \frac{1}{V} \int_V U dV \right)^2 V = \rho \left( \int_V U dV \right)^2 \quad (7.33)$$

The general correction factor is the ratio of the above value to the actual kinetic energy as

$$C_F = \frac{\left(\int_V \rho U dV\right)^2}{\int_V \rho U^2 dV} \neq \frac{\rho (U_{ave})^2 V}{\int_V \rho U^2 dV} \quad (7.34)$$

Here,  $C_F$  is the correction coefficient. Note, the inequality sign because the density distribution for compressible fluid. The correction factor for a constant density fluid is

$$C_F = \frac{\left(\int_V \rho U dV\right)^2}{\int_V \rho U^2 dV} = \frac{\left(\rho \int_V U dV\right)^2}{\rho \int_V U^2 dV} = \frac{U_{ave}^2 V}{\int_V U^2 dV} \quad (7.35)$$

This integral can be evaluated for any given velocity profile. A large family of velocity profiles is laminar or parabolic (for one directional flow)<sup>11</sup>. For a pipe geometry, the velocity is

$$U\left(\frac{r}{R}\right) = U(\bar{r}) = U_{max}(1 - \bar{r}^2) = 2U_{ave}(1 - \bar{r}^2) \quad (7.36)$$

It can be noticed that the velocity is presented as a function of the reduced radius<sup>12</sup>. The relationship between  $U_{max}$  to the averaged velocity,  $U_{ave}$  is obtained by using equation (7.32) which yields 1/2.

Substituting equation (7.36) into equation (7.35) results

$$\frac{U_{ave}^2 V}{\int_V U^2 dV} = \frac{U_{ave}^2 V}{\int_V (2U_{ave}(1 - \bar{r}^2))^2 dV} = \frac{U_{ave}^2 V}{\frac{4U_{ave}^2 \pi L R^2}{3}} = \frac{3}{4} \quad (7.37)$$

The correction factor for many other velocity profiles and other geometries can be smaller or larger than this value. For circular shape, a good guess number is about 1.1. In this case, for simplicity reason, it is assumed that the averaged velocity indeed represent the energy in the tank or container. Calculations according to this point can improve the accurately based on the above discussion.

The difference between the “averaged momentum” velocity and the “averaged kinetic” velocity is also due to the fact that energy is added for different directions while in the momentum case, different directions cancel each other out.

<sup>11</sup>Laminar flow is not necessarily implies that the flow velocity profile is parabolic. The flow is parabolic only when the flow is driven by pressure or gravity. More about this issue in the Differential Analysis Chapter.

<sup>12</sup>The advantage is described in the Dimensional Analysis Chapter.

The unsteady state term then obtains the form

$$\frac{d}{dt} \int_V \rho \left( \frac{U^2}{2} + g y \right) dV \cong \rho \frac{d}{dt} \left( \left[ \frac{\bar{U}^2}{2} + \frac{g h}{2} \right] \overbrace{h A}^V \right) \quad (7.38)$$

The relationship between the boundary velocity to the height (by definition) is

$$U_b = \frac{dh}{dt} \quad (7.39)$$

Therefore, the velocity in the  $z$  direction<sup>13</sup> is

$$U_z = \frac{dh}{dt} \quad (7.40)$$

$$U_e = \frac{A}{A_e} \frac{dh}{dt} = -U_b \frac{dh}{dt} \quad (7.41)$$

Combining all the three components of the velocity (Pythagorean Theorem) as

$$\bar{U}^2 \cong \bar{U}_x^2 + \bar{U}_y^2 + \bar{U}_z^2 \quad (7.42)$$

$$\bar{U}^2 \cong \left( \frac{(\pi - 2) r}{8 h} \frac{dh}{dt} \right)^2 + \left( \frac{(\pi - 1) r}{4 h} \frac{dh}{dt} \right)^2 + \left( \frac{dh}{dt} \right)^2 \quad (7.43)$$

$$\bar{U} \cong \frac{dh}{dt} \sqrt{\overbrace{\left( \frac{(\pi - 2) r}{8 h} \right)^2 + \left( \frac{(\pi - 1) r}{4 h} \right)^2}^{f(G)} + 1^2} \quad (7.44)$$

It can be noticed that  $f(G)$  is a weak function of the height inverse. Analytical solution of the governing equation is possible including this effect of the height. However, the mathematical complication are enormous<sup>14</sup> and this effect is assumed negligible and the function to be constant.

The last term is

$$\int_A \frac{U_e^2}{2} U_e \rho dA = \frac{U_e^2}{2} U_e \rho A_e = \frac{1}{2} \left( \frac{dh}{dt} \frac{A}{A_e} \right)^2 U_e \rho A_e \quad (7.45)$$

<sup>13</sup>A similar point was provided in mass conservation Chapter 5. However, it easy can be proved by construction the same control volume. The reader is encouraged to do it to get acquainted with this concept.

<sup>14</sup>The solution, not the derivation, is about one page. It must be remembered that is effect extremely important in the later stages of the emptying of the tank. But in the same vain, some other effects have to be taken into account which were neglected in construction of this model such as upper surface shape.

Combining all the terms into equation (7.27) results in

$$\rho \frac{d}{dt} \left( \left[ \frac{\bar{U}^2}{2} + \frac{gh}{2} \right] \overbrace{hA}^V \right) - \frac{1}{2} \left( \frac{dh}{dt} \right)^2 \left( \frac{A}{A_e} \right)^2 U_e \rho A_e = 0 \quad (7.46)$$

taking the derivative of first term on l.h.s. results in

$$\frac{d}{dt} \left[ \frac{\bar{U}^2}{2} + \frac{gh}{2} \right] hA + \left[ \frac{\bar{U}^2}{2} + \frac{gh}{2} \right] A \frac{dh}{dt} - \frac{1}{2} \left( \frac{dh}{dt} \right)^2 \left( \frac{A}{A_e} \right)^2 U_e A_e = 0 \quad (7.47)$$

Equation (7.47) can be rearranged and simplified and combined with mass conservation<sup>15</sup>.

— — — — — *Advance material can be skipped* — — — — —

Dividing equation (7.46) by  $U_e A_e$  and utilizing equation (7.40)

$$\frac{d}{dt} \left[ \frac{\bar{U}^2}{2} + \frac{gh}{2} \right] \frac{hA}{U_e A_e} + \left[ \frac{\bar{U}^2}{2} + \frac{gh}{2} \right] \overbrace{\frac{dh}{dt}}^{\frac{A}{A_e} U_e} - \frac{1}{2} \left( \frac{dh}{dt} \right)^2 \left( \frac{A}{A_e} \right)^2 \cancel{U_e A_e} = 0 \quad (7.48)$$

Notice that  $\bar{U} = U_b f(G)$  and thus

$$\overbrace{\frac{d\bar{U}}{dt}}^{f(G) U_b} \frac{hA}{U_e A_e} + \frac{gh}{2} \frac{dh}{dt} \frac{hA}{U_e A_e} + \left[ \frac{\bar{U}^2}{2} + \frac{gh}{2} \right] - \frac{1}{2} \left( \frac{dh}{dt} \right)^2 \left( \frac{A}{A_e} \right)^2 = 0 \quad (7.49)$$

Further rearranging to eliminate the “flow rate” transforms to

$$f(G) h \frac{d\bar{U}}{dt} \left( \frac{U_b A}{U_e A_e} \right) + \frac{gh}{2} \frac{dh}{dt} \frac{A}{A_e} + \left[ \frac{f(G)^2}{2} \left( \frac{dh}{dt} \right)^2 + \frac{gh}{2} \right] - \frac{1}{2} \left( \frac{dh}{dt} \right)^2 \left( \frac{A}{A_e} \right)^2 = 0 \quad (7.50)$$

$$f(G)^2 h \frac{d^2 h}{dt^2} + \frac{gh}{2} + \left[ \frac{f(G)^2}{2} \left( \frac{dh}{dt} \right)^2 + \frac{gh}{2} \right] - \frac{1}{2} \left( \frac{dh}{dt} \right)^2 \left( \frac{A}{A_e} \right)^2 = 0 \quad (7.51)$$

— — — — — *End Advance material* — — — — —

Combining the  $gh$  terms into one yields

<sup>15</sup>This part can be skipped to end of “advanced material”.

$$f(G)^2 h \frac{d^2 h}{dt^2} + g h + \frac{1}{2} \left( \frac{dh}{dt} \right)^2 \left[ f(G)^2 - \left( \frac{A}{A_e} \right)^2 \right] = 0 \quad (7.52)$$

Defining a new tank emptying parameter,  $T_e$ , as

$$T_e = \left( \frac{A}{f(G) A_e} \right)^2 \quad (7.53)$$

This parameter represents the characteristics of the tank which controls the emptying process. Dividing equation (7.52) by  $f(G)^2$  and using this parameter, equation (7.52) after minor rearrangement transformed to

$$h \left( \frac{d^2 h}{dt^2} + \frac{g A_e^2}{T_e A^2} \right) + \frac{1}{2} \left( \frac{dh}{dt} \right)^2 [1 - T_e] = 0 \quad (7.54)$$

The solution can either of these equations<sup>16</sup>

$$- \int \frac{dh}{\sqrt{\frac{(k_1 T_e - 2 k_1) e^{\ln(h) T_e} + 2 g h^2}{h (T_e - 2) f(G)}}} = t + k_2 \quad (7.55)$$

or

$$\int \frac{dh}{\sqrt{\frac{(k_1 T_e - 2 k_1) e^{\ln(h) T_e} + 2 g h^2}{h (T_e - 2) f(G)}}} = t + k_2 \quad (7.56)$$

The solution with the positive solution has no physical meaning because the height cannot increase with time. Thus define function of the height as

$$f(h) = - \int \frac{dh}{\sqrt{\frac{(k_1 T_e - 2 k_1) e^{\ln(h) T_e} + 2 g h^2}{h (T_e - 2) f(G)}}} \quad (7.57)$$

The initial condition for this case are: one the height initial is

$$h(0) = h_0 \quad (7.58)$$

The initial boundary velocity is

$$\frac{dh}{dt} = 0 \quad (7.59)$$

<sup>16</sup>A discussion about this equation appear in the mathematical appendix.

This condition pose a physical limitation<sup>17</sup> which will be ignored. The first condition yields

$$k_2 = -f(h_0) \quad (7.60)$$

The second condition provides

$$\frac{dh}{dt} = 0 = \sqrt{\frac{(k_1 T_e - 2 k_1) e^{\ln(h_0) T_e} + 2 g h_0^2}{h_0 (T_e - 2) f(G)}} \quad (7.61)$$

The complication of the above solution suggest a simplification in which

$$\frac{d^2 h}{dt^2} \ll \frac{g A_e^2}{T_e A^2} \quad (7.62)$$

which reduces equation (7.54) into

$$h \left( \frac{g A_e^2}{T_e A^2} \right) + \frac{1}{2} \left( \frac{dh}{dt} \right)^2 [1 - T_e] = 0 \quad (7.63)$$

While equation (7.63) is still non linear equation, the non linear element can be removed by taking negative branch (height reduction) of the equation as

$$\left( \frac{dh}{dt} \right)^2 = \frac{2 g h}{-1 + \left( \frac{A}{A_e} \right)^2} \quad (7.64)$$

It can be noticed that  $T_e$  “disappeared” from the equation. And taking the “positive” branch

$$\frac{dh}{dt} = \frac{\sqrt{2 g h}}{\sqrt{1 - \left( \frac{A}{A_e} \right)^2}} \quad (7.65)$$

The nature of first order Ordinary Differential Equation that they allow only one initial condition. This initial condition is the initial height of the liquid. The initial velocity field was eliminated by the approximation (remove the acceleration term). Thus it is assumed that the initial velocity is not relevant at the core of the process at hand. It is correct only for large ratio of  $h/r$  and the error became very substantial for small value of  $h/r$ .

Equation (7.65) integrated to yield

$$\left( 1 - \left( \frac{A}{A_e} \right)^2 \right) \int_{h_0}^h \frac{dh}{\sqrt{2 g h}} = \int_0^t dt \quad (7.66)$$

<sup>17</sup>For the initial condition speed of sound has to be taken into account. Thus for a very short time, the information about opening of the valve did not reached to the surface. This information travel in characteristic sound speed which is over 1000 *m/sec*. However, if this phenomenon is ignored this solution is correct.

The initial condition has been inserted into the integral which its solution is

$$\left(1 - \left(\frac{A}{A_e}\right)^2\right) \frac{h - h_0}{\sqrt{2gh}} = t \quad (7.67)$$

$$U_e = \frac{dh}{dt} \frac{A}{A_e} = \frac{\sqrt{2gh}}{\sqrt{1 - \left(\frac{A}{A_e}\right)^2}} \frac{A}{A_e} = \frac{\sqrt{2gh}}{\sqrt{1 - \left(\frac{A_e}{A}\right)^2}} \quad (7.68)$$

If the area ratio  $A_e/A \ll 1$  then

$$U \cong \sqrt{2gh} \quad (7.69)$$

Equation (7.69) is referred in the literature as Torricelli's equation<sup>18</sup>

This analysis has several drawbacks which limits the accuracy of the calculations. Yet, this analysis demonstrates the usefulness of the integral analysis to provide a reasonable solution. This analysis can be improved by experimental investigating the phenomenon. The experimental coefficient can be added to account for the dissipation and other effects such

$$\frac{dh}{dt} \cong C \sqrt{2gh} \quad (7.70)$$

The loss coefficient can be expressed as

$$C = Kf \left(\frac{U^2}{2}\right) \quad (7.71)$$

A few loss coefficients for different configuration is given following Figure 7.4.

## 7.2 Limitation of Integral Approach

Some of accuracy issues to enhance the quality and improvements of the integral method were suggested in the analysis of the emptying tank. There are problems that the integral methods even with these enhancements simply cannot tackle.

The improvements to the integral methods are the corrections to the estimates of the energy or other quantities in the conservation equations. In the calculations of the exit velocity of a tank, two such corrections were presented. The first type is the prediction of the velocities profile (or the concentration profile). The second type of corrections is the understanding that averaged of the total field is different from the averaged of different zooms. In the case of the tank, the averaged velocity

<sup>18</sup>Evangelista Torricelli (October 15, 1608 – October 25, 1647) was an Italian physicist and mathematician. He derived this equation based on similar principle to Bernoulli equation (which later leads to Bernoulli's equation). Today the exact reference to his work is lost and only "sketches" of his lecture elude work. He was student (not formal) and follower of Galileo Galilei. It seems that Torricelli was an honest man who gave to others and he died at young age of 39 while in his prime.

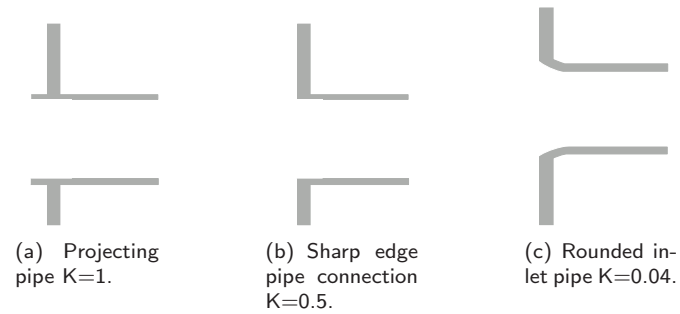

Fig. -7.4. Typical resistance for selected outlet configuration.

in  $x$  direction is zero yet the averaged velocity in the two zooms (two halves) is not zero. In fact, the averaged energy in the  $x$  direction contributes or effects the energy equation. The accuracy issues that integral methods intrinsically suffers from no ability to exact flow field and thus lost the accuracy as was discussed in the example. The integral method does not handle the problems such as the free surface with reasonable accuracy. Furthermore, the knowledge of whether the flow is laminar or turbulent (later on this issue) has to come from different techniques. Hence the prediction can skew the actual predictions.

In the analysis of the tank it was assumed that the dissipation can be ignored. In cases that dissipation play major role, the integral does not provide a sufficient tool to analyze the issue at hand. For example, the analysis of the oscillating manometer cannot be carried by the integral methods. A liquid in manometer is disturbed from a rest by a distance of  $H_0$ . The description  $H(t)$  as a function of time requires exact knowledge of the velocity field. Additionally, the integral methods is too crude to handle issues of free interface. These problem were minor for the emptying the tank but for the oscillating manometer it is the core of the problem. Hence different techniques are required.

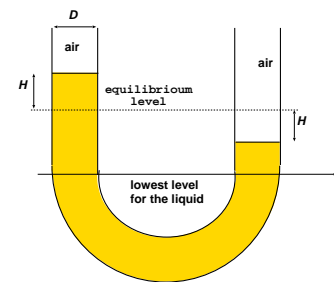

Fig. -7.5. Flow in an oscillating manometer.

The discussion on the limitations was not provided to discard usage of this method but rather to provide a guidance of use with caution. The integral method is a powerful and yet simple method but has has to be used with the limitations of the method in mind.



### 7.3 Approximation of Energy Equation

The emptying the tank problem was complicated even with all the simplifications that were carried. Engineers in order to reduce the work further simplify the energy equation. It turn out that these simplifications can provide reasonable results and key understanding of the physical phenomena and yet with less work, the problems can be solved. The following sections provides further explanation.

#### 7.3.1 Energy Equation in Steady State

The steady state situation provides several ways to reduce the complexity. The time derivative term can be eliminated since the time derivative is zero. The acceleration term must be eliminated for the obvious reason. Hence the energy equation is reduced to

$$\dot{Q} - \dot{W}_{shear} - \dot{W}_{shaft} = \int_S \left( h + \frac{U^2}{2} + gz \right) U_{rn} \rho dA + \int_S P U_{bn} dA \quad (7.72)$$

If the flow is uniform or can be estimated as uniform, equation (7.72) is reduced to

$$\dot{Q} - \dot{W}_{shear} - \dot{W}_{shaft} = \left( h + \frac{U^2}{2} + gz \right) U_{rn} \rho A_{out} - \left( h + \frac{U^2}{2} + gz \right) U_{rn} \rho A_{in} + P U_{bn} A_{out} - P U_{bn} A_{in} \quad (7.73)$$

It can be noticed that last term in equation (7.73) for non-deformable control volume does not vanished. The reason is that while the velocity is constant, the pressure is different. For a stationary fix control volume the energy equation, under this simplification transformed to

$$\dot{Q} - \dot{W}_{shear} - \dot{W}_{shaft} = \left( h + \frac{U^2}{2} + gz \right) U_{rn} \rho A_{out} - \left( h + \frac{U^2}{2} + gz \right) U_{rn} \rho A_{in} \quad (7.74)$$

Dividing equation the mass flow rate provides

$$\dot{q} - \dot{w}_{shear} - \dot{w}_{shaft} = \left( h + \frac{U^2}{2} + gz \right) \Big|_{out} - \left( h + \frac{U^2}{2} + gz \right) \Big|_{in} \quad (7.75)$$

### 7.3.2 Energy Equation in Frictionless Flow and Steady State

In cases where the flow can be estimated without friction or where a quick solution is needed the friction and other losses are illuminated from the calculations. This imaginary fluid reduces the amount of work in the calculations and Ideal Flow Chapter is dedicated in this book. The second law is the core of “no losses” and can be employed when calculations of this sort information is needed. Equation (2.21) which can be written as

$$dq_{rev} = T ds = dE_u + P dv \quad (7.76)$$

Using the multiplication rule change equation (7.76)

$$dq_{rev} = dE_u + d(Pv) - v dP = dE_u + d\left(\frac{P}{\rho}\right) - v dP \quad (7.77)$$

integrating equation (7.77) yields

$$\int dq_{rev} = \int dE_u + \int d\left(\frac{P}{\rho}\right) - \int v dP \quad (7.78)$$

$$q_{rev} = E_u + \left(\frac{P}{\rho}\right) - \int \frac{dP}{\rho} \quad (7.79)$$

Integration over the entire system results in

$$Q_{rev} = \int_V \overbrace{\left(E_u + \left(\frac{P}{\rho}\right)\right)}^h \rho dV - \int_V \left(\int \frac{dP}{\rho}\right) \rho dV \quad (7.80)$$

Taking time derivative of the equation (7.80) becomes

$$\dot{Q}_{rev} = \frac{D}{Dt} \int_V \overbrace{\left(E_u + \left(\frac{P}{\rho}\right)\right)}^h \rho dV - \frac{D}{Dt} \int_V \left(\int \frac{dP}{\rho}\right) \rho dV \quad (7.81)$$

Using the Reynolds Transport Theorem to transport equation to control volume results in

$$\dot{Q}_{rev} = \frac{d}{dt} \int_V h \rho dV + \int_A h U_{rn} \rho dA + \frac{D}{Dt} \int_V \left(\int \frac{dP}{\rho}\right) \rho dV \quad (7.82)$$

As before equation (7.81) can be simplified for uniform flow as

$$\dot{Q}_{rev} = \dot{m} \left[ (h_{out} - h_{in}) - \left( \int \frac{dP}{\rho} \Big|_{out} - \int \frac{dP}{\rho} \Big|_{in} \right) \right] \quad (7.83)$$

or

$$\dot{q}_{rev} = (h_{out} - h_{in}) - \left( \int \frac{dP}{\rho} \Big|_{out} - \int \frac{dP}{\rho} \Big|_{in} \right) \quad (7.84)$$

Subtracting equation (7.84) from equation (7.75) results in

$$0 = w_{shaft} + \underbrace{\left( \int \frac{dP}{\rho} \Big|_2 - \int \frac{dP}{\rho} \Big|_1 \right)}_{\text{change in pressure energy}} + \underbrace{\frac{U_2^2 - U_1^2}{2}}_{\text{change in kinetic energy}} + \underbrace{g(z_2 - z_1)}_{\text{change in potential energy}} \quad (7.85)$$

Equation (7.85) for constant density is

$$0 = w_{shaft} + \frac{P_2 - P_1}{\rho} + \frac{U_2^2 - U_1^2}{2} + g(z_2 - z_1) \quad (7.86)$$

For no shaft work equation (7.86) reduced to

$$0 = \frac{P_2 - P_1}{\rho} + \frac{U_2^2 - U_1^2}{2} + g(z_2 - z_1) \quad (7.87)$$

## 7.4 Energy Equation in Accelerated System

In the discussion so far, it was assumed that the control volume is at rest. The only acceptance to the above statement, is the gravity that was compensated by the gravity potential. In building the gravity potential it was assumed that the gravity is a conservative force. It was pointed earlier in this book that accelerated forces can be translated to potential force. In many cases, the control volume is moving in accelerated coordinates. These accelerations will be translated to potential energy.

The accelerations are referring to two kinds of acceleration, linear and rotational. There is no conceptual difference between these two accelerations. However, the mathematical treatment is somewhat different which is the reason for the separation. General Acceleration can be broken into a linear acceleration and a rotating acceleration.

### 7.4.1 Energy in Linear Acceleration Coordinate

The potential is defined as

$$P.E. = - \int_{ref}^{r^2} \mathbf{F} \cdot d\mathbf{l} \quad (7.88)$$

In Chapter 3 a discussion about gravitational energy potential was presented. For example, for the gravity force is

$$F = - \frac{G M m}{r^2} \quad (7.89)$$

Where  $G$  is the gravity coefficient and  $M$  is the mass of the Earth.  $r$  and  $m$  are the distance and mass respectively. The gravity potential is then

$$PE_{gravity} = - \int_{\infty}^r - \frac{G M m}{r^2} dr \quad (7.90)$$

The reference was set to infinity. The gravity force for fluid element in small distance then is  $g dz dm$ . The work this element moving from point 1 to point 2 is

$$\int_1^2 g dz dm = g (z_2 - z_1) dm \quad (7.91)$$

The total work or potential is the integral over the whole mass.

### 7.4.2 Linear Accelerated System

The acceleration can be employed in similar fashion as the gravity force. The linear acceleration “creates” a conservative force of constant force and direction. The “potential” of moving the mass in the field provides the energy. The Force due to the acceleration of the field can be broken into three coordinates. Thus, the element of the potential is

$$dPE_a = \mathbf{a} \cdot d\mathbf{l} dm \quad (7.92)$$

The total potential for element material

$$PE_a = \int_{(0)}^{(1)} \mathbf{a} \cdot d\mathbf{l} dm = (a_x (x_1 - x_0) a_y (y_1 - y_0) a_z (z_1 - z_0)) dm \quad (7.93)$$

At the origin (of the coordinates)  $x = 0$ ,  $y = 0$ , and  $z = 0$ . Using this trick the notion of the  $a_x (x_1 - x_0)$  can be replaced by  $a_x x$ . The same can be done for the other two coordinates. The potential of unit material is

$$PE_{a\text{total}} = \int_{sys} (a_x x + a_y y + a_z z) \rho dV \quad (7.94)$$

The change of the potential with time is

$$\frac{D}{Dt} PE_{a\text{total}} = \frac{D}{Dt} \int_{sys} (a_x x + a_y y + a_z z) dm \quad (7.95)$$

Equation can be added to the energy equation as

$$\dot{Q} - \dot{W} = \frac{D}{Dt} \int_{sys} \left[ E_u + \frac{U^2}{2} + a_x x + a_y y + (a_z + g)z \right] \rho dV \quad (7.96)$$

The Reynolds Transport Theorem is used to transferred the calculations to control volume as

#### Energy Equation in Linear Accelerated Coordinate

$$\begin{aligned} \dot{Q} - \dot{W} = & \frac{d}{dt} \int_{cv} \left[ E_u + \frac{U^2}{2} + a_x x + a_y y + (a_z + g)z \right] \rho dV \\ & + \int_{cv} \left( h + \frac{U^2}{2} + a_x x + a_y y + (a_z + g)z \right) U_{rn} \rho dA \\ & + \int_{cv} P U_{bn} dA \end{aligned} \quad (7.97)$$

### 7.4.3 Energy Equation in Rotating Coordinate System

The coordinate system rotating around fix axes creates a similar conservative potential as a linear system. There are two kinds of acceleration due to this rotation; one is the centrifugal and one the Coriolis force. To understand it better, consider a particle which moves with the our rotating system. The forces acting on particles are

$$\mathbf{F} = \left( \overbrace{\omega^2 r \hat{r}}^{\text{centrifugal}} + \overbrace{2\mathbf{U} \times \boldsymbol{\omega}}^{\text{Coriolis}} \right) dm \quad (7.98)$$

The work or the potential then is

$$PE = (\omega^2 r \hat{r} + 2\mathbf{U} \times \boldsymbol{\omega}) \cdot d\boldsymbol{\ell} dm \quad (7.99)$$

The cylindrical coordinate are

$$d\boldsymbol{\ell} = dr \hat{r} + r d\theta \hat{\theta} + dz \hat{k} \quad (7.100)$$

where  $\hat{r}$ ,  $\hat{\theta}$ , and  $\hat{k}$  are units vector in the coordinates  $r$ ,  $\theta$  and  $z$  respectively. The potential is then

$$PE = (\omega^2 r \hat{r} + 2\mathbf{U} \times \boldsymbol{\omega}) \cdot (dr \hat{r} + r d\theta \hat{\theta} + dz \hat{k}) dm \quad (7.101)$$

The first term results in  $\omega^2 r^2$  (see for explanation in the appendix 567 for vector explanation). The cross product is zero of

$$\mathbf{U} \times \boldsymbol{\omega} \times \mathbf{U} = \mathbf{U} \times \boldsymbol{\omega} \times \boldsymbol{\omega} = 0$$

because the first multiplication is perpendicular to the last multiplication. The second part is

$$(2\mathbf{U} \times \boldsymbol{\omega}) \cdot d\boldsymbol{\ell} dm \quad (7.102)$$

This multiplication does not vanish with the exception of the direction of  $\mathbf{U}$ . However, the most important direction is the direction of the velocity. This multiplication creates lines (surfaces ) of constant values. From a physical point of view, the flux of this property is important only in the direction of the velocity. Hence, this term canceled and does not contribute to the potential.

The net change of the potential energy due to the centrifugal motion is

$$PE_{\text{centrifugal}} = - \int_1^2 \omega^2 r^2 dr dm = \frac{\omega^2 (r_1^2 - r_2^2)}{2} dm \quad (7.103)$$

Inserting the potential energy due to the centrifugal forces into the energy equation yields

**Energy Equation in Accelerated Coordinate**

$$\begin{aligned} \dot{Q} - \dot{W} = & \frac{d}{dt} \int_{cv} \left[ E_u + \frac{U^2}{2} + a_x x + a_y y + (a_z + g)z - \frac{\omega^2 r^2}{2} \right] \rho dV \\ & + \int_{cv} \left( h + \frac{U^2}{2} + a_x x + a_y y + (a_z + g)z - z \frac{\omega^2 r^2}{2} \right) U_{rn} \rho dA \\ & + \int_{cv} P U_{bn} dA \end{aligned} \quad (7.104)$$

## 7.4.4 Simplified Energy Equation in Accelerated Coordinate

### 7.4.4.1 Energy Equation in Accelerated Coordinate with Uniform Flow

One of the way to simplify the general equation (7.104) is to assume uniform flow. In that case the time derivative term vanishes and equation (7.104) can be written as

**Energy Equation in steady state**

$$\begin{aligned} \dot{Q} - \dot{W} = & \int_{cv} \left( h + \frac{U^2}{2} + a_x x + a_y y + (a_z + g)z - z \frac{\omega^2 r^2}{2} \right) U_{rn} \rho dA \\ & + \int_{cv} P U_{bn} dA \end{aligned} \quad (7.105)$$

Further simplification of equation (7.105) by assuming uniform flow for which

$$\begin{aligned} \dot{Q} - \dot{W} = & \left( h + \frac{\bar{U}^2}{2} + a_x x + a_y y + (a_z + g)z - z \frac{\omega^2 r^2}{2} \right) \bar{U}_{rn} \rho dA \\ & + \int_{cv} P \bar{U}_{bn} dA \end{aligned} \quad (7.106)$$

Note that the acceleration also have to be averaged. The correction factors have to introduced into the equation to account for the energy averaged verse to averaged velocity (mass averaged). These factor make this equation with larger error and thus less effective tool in the engineering calculation.

## 7.4.5 Energy Losses in Incompressible Flow

In the previous sections discussion, it was assumed that there are no energy loss. However, these losses are very important for many real world application. And these losses

have practical importance and have to be considered in engineering system. Hence writing equation (7.15) when the energy and the internal energy as a separate identity as

$$\begin{aligned} \dot{W}_{shaft} = & \frac{d}{dt} \int_V \left( \frac{U^2}{2} + gz \right) \rho dV + \\ & \int_A \left( \frac{P}{\rho} + \frac{U^2}{2} + gz \right) U_{rn} \rho dA + \int_A PU_{bn} dA + \\ & \underbrace{\hspace{10em}}_{\text{energy loss}} \\ & \frac{d}{dt} \int_V E_u \rho dV + \int_A E_u U_{rn} \rho dA - \dot{Q} - \dot{W}_{shear} \end{aligned} \quad (7.107)$$

Equation (7.107) sometimes written as

$$\begin{aligned} \dot{W}_{shaft} = & \frac{d}{dt} \int_V \left( \frac{U^2}{2} + gz \right) \rho dV + \\ & \int_A \left( \frac{P}{\rho} + \frac{U^2}{2} + gz \right) U_{rn} \rho dA + \int_A PU_{bn} dA + \text{energy loss} \end{aligned} \quad (7.108)$$

Equation can be further simplified under assumption of uniform flow and steady state as

$$\dot{w}_{shaft} = \left( \frac{P}{\rho} + \frac{U^2}{2} + gz \right) \Big|_{out} - \left( \frac{P}{\rho} + \frac{U^2}{2} + gz \right) \Big|_{in} + \text{energy loss} \quad (7.109)$$

Equation (7.109) suggests that term  $h + \frac{U^2}{2} + gz$  has a special meaning (because it remained constant under certain conditions). This term, as will be shown, has to be constant for frictionless flow without any addition and loss of energy. This term represents the “potential energy.” The loss is the combination of the internal energy/enthalpy with heat transfer. For example, fluid flow in a pipe has resistance and energy dissipation. The dissipation is lost energy that is transferred to the surroundings. The loss is normally is a strong function of the velocity square,  $U^2/2$ . There are several categories of the loss which referred as minor loss (which are not minor), and duct losses. These losses will be tabulated later on.

If the energy loss is negligible and the shaft work vanished or does not exist equation (7.109) reduces to simple Bernoulli's equation.

Simple Bernoulli

$$0 = \left( \frac{P}{\rho} + \frac{U^2}{2} + gz \right) \Big|_{out} - \left( \frac{P}{\rho} + \frac{U^2}{2} + gz \right) \Big|_{in} \quad (7.110)$$

Equation (7.110) is only a simple form of Bernoulli's equation which was developed by Bernoulli's adviser, Euler. There also unsteady state and other form of this equation that will be discussed in differential equations Chapter.

## 7.5 Examples of Integral Energy Conservation

### Example 7.1:

Consider a flow in a long straight pipe. Initially the flow is in a rest. At time,  $t_0$  the a constant pressure difference is applied on the pipe. Assume that flow is incompressible, and the resistance or energy loss is  $f$ . Furthermore assume that this loss is a function of the velocity square. Develop equation to describe the exit velocity as a function of time. State your assumptions.

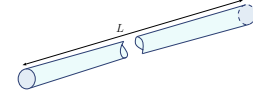

Fig. -7.6. Flow in a long pipe when exposed to a jump in the pressure difference.

### SOLUTION

The mass balance on the liquid in the pipe results in

$$0 = \overbrace{\int_V \frac{\partial \rho}{\partial t} dV}^{=0} + \overbrace{\int_A \rho U_{bn} dA}^{=0} + \int_A \rho U_{rn} dA \implies \rho A U_{in} = \rho A U_{exit} \quad (7.1.a)$$

There is no change in the liquid mass inside pipe and therefore the time derivative is zero (the same mass resides in the pipe at all time). The boundaries do not move and the second term is zero. Thus, the flow in and out are equal because the density is identical. Furthermore, the velocity is identical because the cross area is same.

It can be noticed that for the energy balance on the pipe, the time derivative can enter the integral because the control volume has fixed boundaries. Hence,

$$\dot{Q} - \overbrace{\dot{W}_{shear}}^{=0} + \overbrace{\dot{W}_{shaft}}^{=0} = \int_V \frac{d}{dt} \left( E_u + \frac{U^2}{2} + g z \right) \rho dV + \int_S \left( h + \frac{U^2}{2} + g z \right) U_{rn} \rho dA + \int_S P U_{bn} dA \quad (7.1.b)$$

The boundaries shear work vanishes because the same arguments present before (the work, where velocity is zero, is zero. In the locations where the velocity does not vanished, such as in and out, the work is zero because shear stress are perpendicular to the velocity).

There is no shaft work and this term vanishes as well. The first term on the right hand side (with a constant density) is

$$\rho \int_{V_{pipe}} \frac{d}{dt} \left( E_u + \frac{U^2}{2} + \overbrace{g z}^{constant} \right) dV = \rho U \frac{dU}{dt} \overbrace{V_{pipe}}^{L \pi r^2} + \rho \int_{V_{pipe}} \frac{d}{dt} (E_u) dV \quad (7.1.c)$$

where  $L$  is the pipe length,  $r$  is the pipe radius,  $U$  averaged velocity.

In this analysis, it is assumed that the pipe is perpendicular to the gravity line and thus the gravity is constant. The gravity in the first term and all other terms, related to



the pipe, vanish again because the value of  $z$  is constant. Also, as can be noticed from equation (7.1.a), the velocity is identical (in and out). Hence the second term becomes

$$\int_A \left( h + \left( \frac{U^2}{2} + gz \right) \right) \rho U_{rn} dA = \int_A \overbrace{\left( E_u + \frac{P}{\rho} \right)}^h \rho U_{rn} dA \quad (7.1.d)$$

Equation (7.1.d) can be further simplified (since the area and averaged velocity are constant, additionally notice that  $U = U_{rn}$ ) as

$$\int_A \left( E_u + \frac{P}{\rho} \right) \rho U_{rn} dA = \Delta P U A + \int_A \rho E_u U_{rn} dA \quad (7.1.e)$$

The third term vanishes because the boundaries velocities are zero and therefore

$$\int_A P U_{bn} dA = 0 \quad (7.1.f)$$

Combining all the terms results in

$$\dot{Q} = \rho U \frac{dU}{dt} \overbrace{V_{pipe}}^{L \pi r^2} + \rho \frac{d}{dt} \int_{V_{pipe}} E_u dV + \Delta P U A + \int_A \rho E_u U dA \quad (7.1.g)$$

equation (7.1.g) can be rearranged as

$$\overbrace{\dot{Q} - \rho \int_{V_{pipe}} \frac{d(E_u)}{dt} dV}^{-K \frac{U^2}{2}} - \int_A \rho E_u U dA = \rho L \pi r^2 U \frac{dU}{dt} + (P_{in} - P_{out}) U \quad (7.1.h)$$

The terms on the LHS (left hand side) can be combined. It common to assume (to view) that these terms are representing the energy loss and are a strong function of velocity square<sup>19</sup>. Thus, equation (7.1.h) can be written as

$$-K \frac{U^2}{2} = \rho L \pi r^2 U \frac{dU}{dt} + (P_{in} - P_{out}) U \quad (7.1.i)$$

Dividing equation (7.1.i) by  $K U/2$  transforms equation (7.1.i) to

$$U + \frac{2 \rho L \pi r^2}{K} \frac{dU}{dt} = \frac{2(P_{in} - P_{out})}{K} \quad (7.1.j)$$

Equation (7.1.j) is a first order differential equation. The solution this equation is described in the appendix and which is

$$U = e^{-\left( \frac{t K}{2 \pi r^2 \rho L} \right)} \left( \frac{2(P_{in} - P_{out})}{K} e^{\left( \frac{t K}{2 \pi r^2 \rho L} \right)} + c \right) e^{\left( \frac{2 \pi r^2 \rho t L}{K} \right)} \quad (7.1.k)$$

<sup>19</sup>The shear work inside the liquid refers to molecular work (one molecule work on the other molecule). This shear work can be viewed also as one control volume work on the adjoined control volume.

Applying the initial condition,  $U(t = 0) = 0$  results in

$$U = \frac{2(P_{in} - P_{out})}{K} \left( 1 - e^{-\left(\frac{tK}{2\pi r^2 \rho L}\right)} \right) \quad (7.1.l)$$

The solution is an exponentially approaching the steady state solution. In steady state the flow equation (7.1.j) reduced to a simple linear equation. The solution of the linear equation and the steady state solution of the differential equation are the same.

$$U = \frac{2(P_{in} - P_{out})}{K} \quad (7.1.m)$$

Another note, in reality the resistance,  $K$ , is not constant but rather a strong function of velocity (and other parameters such as temperature<sup>20</sup>, velocity range, velocity regime and etc.). This function will be discussed in a greater extent later on. Additionally, it should be noted that if momentum balance was used a similar solution (but not the same) was obtained (why? hint the difference of the losses accounted for).

---

End Solution

---

The following example combined the above discussion in the text with the above example (7.1).

#### Example 7.2:

A large cylindrical tank with a diameter,  $D$ , contains liquid to height,  $h$ . A long pipe is connected to a tank from which the liquid is emptied. To analysis this situation, consider that the tank has a constant pressure above liquid (actually a better assumption of air with a constant mass.). The pipe is exposed to the surroundings and thus the pressure is  $P_{atmos}$  at the pipe exit. Derive approximated equations that related the height in the large tank and the exit velocity at the pipe to pressure difference. Assume that the liquid is incompressible. Assume that the resistance or the friction in the pipe is a strong function to the velocity square in the tank. State all the assumptions that were made during the derivations.

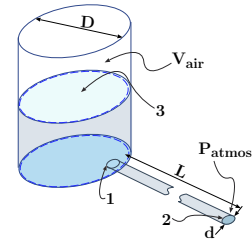

Fig. -7.7. Liquid exiting a large tank trough a long tube.

#### SOLUTION

---

<sup>20</sup>Via the viscosity effects.

This problem can split into two control volumes; one of the liquid in the tank and one of the liquid in pipe. Analysis of control volume in the tank was provided previously and thus needed to be sewed to Example 7.1. Note, the energy loss is considered (as opposed to the discussion in the text). The control volume in tank is depicted in Figure 7.7.

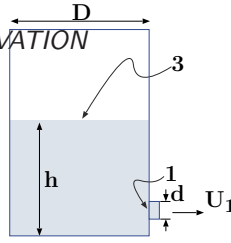

Fig. -7.8. Tank control volume for Example 7.2.

### Tank Control Volume

The effect of the energy change in air side was neglected. The effect is negligible in most cases because air mass is small with exception the “spring” effect (expansion/compression effects). The mass conservation reads

$$\overbrace{\int_V \frac{\partial \rho}{\partial t} dV}^{=0} + \int_A \rho U_{bn} dA + \int_A \rho U_{rn} dA = 0 \quad (7.11.a)$$

The first term vanishes and the second and third terms remain and thus equation (7.11.a) reduces to

$$\rho U_1 A_{pipe} = \rho U_3 \overbrace{\pi R^2}^{A_{tank}} = \rho \frac{dh}{dt} \overbrace{\pi R^2}^{A_{tank}} \quad (7.11.b)$$

It can be noticed that  $U_3 = dh/dt$  and  $D = 2R$  and  $d = 2r$  when the lower case refers to the pipe and the upper case referred to the tank. Equation (7.11.b) simply can be written when the area ratio is used (to be changed later if needed) as

$$U_1 A_{pipe} = \frac{dh}{dt} A_{tank} \implies U_1 = \left(\frac{R}{r}\right)^2 \frac{dh}{dt} \quad (7.11.c)$$

The boundaries shear work and the shaft work are assumed to be vanished in the tank. Therefore, the energy conservation in the tank reduces to

$$\dot{Q} - \overbrace{\dot{W}_{shear}}^{=0} + \overbrace{\dot{W}_{shaft}}^{=0} = \frac{d}{dt} \int_{V_t} \left( E_u + \frac{U_t^2}{2} + g z \right) \rho dV + \int_{A_1} \left( h + \frac{U_t^2}{2} + g z \right) U_{rn} \rho dA + \int_{A_3} P U_{bn} dA \quad (7.11.d)$$

Where  $U_t$  denotes the (the upper surface) liquid velocity of the tank. Moving all internal energy terms and the energy transfer to the right hand side of equation (7.11.d)

to become

$$\begin{aligned} \frac{d}{dt} \int_{V_t} \left( \frac{U_t^2}{2} + gz \right) \rho dV + \int_{A_1} \left( \frac{P}{\rho} + \frac{U_t^2}{2} + gz \right) \overbrace{U_{rn}}^{U_1} \rho dA + \\ \int_{A_3} P \overbrace{U_{bn}}^{U_3} dA = \overbrace{\frac{d}{dt} \int_{V_t} E_u \rho dV + \int_{A_1} E_u \rho U_{rn} dA}^{K \frac{U_t^2}{2}} - \dot{Q} \end{aligned} \quad (7.111)$$

Similar arguments to those that were used in the previous discussion are applicable to this case. Using equation (7.38), the first term changes to

$$\frac{d}{dt} \int_V \rho \left( \frac{U^2}{2} + gz \right) dV \cong \rho \frac{d}{dt} \left( \left[ \frac{\overline{U_t^2}}{2} + \frac{gh}{2} \right] \overbrace{hA}^V \right) \quad (7.11.e)$$

Where the velocity is given by equation (7.44). That is, the velocity is a derivative of the height with a correction factor,  $U = dh/dt \times f(G)$ . Since the focus in this book is primarily on the physics,  $f(G) \equiv 1$  will be assumed. The pressure component of the second term is

$$\int_A \frac{P}{\rho} U_{rn} \rho dA = \rho P_1 U_1 A_1 \quad (7.11.f)$$

It is assumed that the exit velocity can be averaged (neglecting the velocity distribution effects). The second term can be recognized as similar to those by equation (7.45). Hence, the second term is

$$\int_A \left( \frac{U^2}{2} + \overbrace{gz}^{z=0} \right) U_{rn} \rho dA \cong \frac{1}{2} \left( \frac{dh}{dt} \frac{A_3}{A_1} \right)^2 U_1 \rho A_1 = \frac{1}{2} \left( \frac{dh}{dt} \frac{R}{r} \right)^2 U_1 \rho A_1 \quad (7.11.g)$$

The last term on the left hand side is

$$\int_A P U_{bn} dA = P_3 A \frac{dh}{dt} \quad (7.11.h)$$

The combination of all the terms for the tank results in

$$\frac{d}{dt} \left( \left[ \frac{\overline{U_t^2}}{2} + \frac{gh}{2} \right] \overbrace{hA}^V \right) - \frac{1}{2} \left( \frac{dh}{dt} \right)^2 \left( \frac{A_3}{A_1} \right)^2 U_1 A_1 + \frac{K_t}{2\rho} \left( \frac{dh}{dt} \right)^2 = \frac{(P_3 - P_1)}{\rho} \quad (7.11.i)$$

### Pipe Control Volume

The analysis of the liquid in the pipe is similar to Example 7.1. The conservation of the liquid in the pipe is the same as in Example 7.1 and thus equation (7.1.a) is used

$$U_1 = U_2 \quad (7.11.j)$$

$$U_p + \frac{4\rho L \pi r^2}{K_p} \frac{dU_p}{dt} = \frac{2(P_1 - P_2)}{K_p} \quad (7.11.k)$$

where  $K_p$  is the resistance in the pipe and  $U_p$  is the (averaged) velocity in the pipe. Using equation (7.11.c) eliminates the  $U_p$  as

$$\frac{dh}{dt} + \frac{4\rho L \pi r^2}{K} \frac{d^2 h}{dt^2} = \left(\frac{R}{r}\right)^2 \frac{2(P_1 - P_2)}{K_p} \quad (7.11.l)$$

Equation (7.11.l) can be rearranged as

$$\frac{K_p}{2\rho} \left(\frac{r}{R}\right)^2 \left(\frac{dh}{dt} + \frac{4\rho L \pi r^2}{K} \frac{d^2 h}{dt^2}\right) = \frac{(P_1 - P_2)}{\rho} \quad (7.11.m)$$

### Solution

The equations (7.11.m) and (7.11.i) provide the frame in which the liquid velocity in tank and pipe have to be solved. In fact, it can be noticed that the liquid velocity in the tank is related to the height and the liquid velocity in the pipe. Thus, there is only one equation with one unknown. The relationship between the height was obtained by substituting equation (7.11.c) in equation (7.11.m). The equations (7.11.m) and (7.11.i) have two unknowns ( $dh/dt$  and  $P_1$ ) which are sufficient to solve the problem. It can be noticed that two initial conditions are required to solve the problem.

The governing equation obtained by from adding equation (7.11.m) and (7.11.i) as

$$\frac{d}{dt} \left( \left[ \frac{\overline{U}_t^2}{2} + \frac{gh}{2} \right] \overbrace{hA}^V \right) - \frac{1}{2} \left( \frac{dh}{dt} \right)^2 \left( \frac{A_3}{A_1} \right)^2 U_1 A_1 + \frac{K_t}{2\rho} \left( \frac{dh}{dt} \right)^2 + \frac{K_p}{2\rho} \left( \frac{r}{R} \right)^2 \left( \frac{dh}{dt} + \frac{4\rho L \pi r^2}{K} \frac{d^2 h}{dt^2} \right) = \frac{(P_3 - P_2)}{\rho} \quad (7.11.n)$$

The initial conditions are that zero initial velocity in the tank and pipe. Additionally, the height of liquid is at prescript point as

$$\begin{aligned} h(0) &= h_0 \\ \frac{dh}{dt}(0) &= 0 \end{aligned} \quad (7.11.o)$$

The solution of equation can be obtained using several different numerical techniques. The dimensional analysis method can be used to obtain solution various situations which will be presented later on.

---

End Solution

---

### Qualitative Questions

- A liquid flows in and out from a long pipe with uniform cross section as single phase. Assume that the liquid is slightly compressible. That is the liquid has a

constant bulk modulus,  $B_T$ . What is the direction of the heat from the pipe or in to the pipe. Explain why the direction based on physical reasoning. What kind of internal work the liquid performed. Would happen when the liquid velocity is very large? What it will be still correct.

- A different liquid flows in the same pipe. If the liquid is compressible what is the direction of the heat to keep the flow isothermal?
- A tank is full of incompressible liquid. A certain point the tank is punctured and the liquid flows out. To keep the tank at uniform temperature what is the direction of the heat (from the tank or to the tank)?

**Part II**

**Differential Analysis**





---

---

# CHAPTER 8

---

## Differential Analysis

### 8.1 Introduction

The integral analysis has a limited accuracy, which leads to a different approach of differential analysis. The differential analysis allows the flow field investigation in greater detail. In differential analysis, the emphasis is on infinitesimal scale and thus the analysis provides better accuracy<sup>1</sup>. This analysis leads to partial differential equations which are referred to as the Navier-Stokes equations. These equations are named after Claude-Louis Navier-Marie and George Gabriel Stokes. Like many equations they were independently derived by several people. First these equations were derived by Claude-Louis-Marie Navier as it is known in 1827. As usual Simon-Denis Poisson independently, as he done to many other equations or conditions, derived these equations in 1831 for the same arguments as Navier. The foundations for their arguments or motivations are based on a molecular view of how stresses are exerted between fluid layers. Barré de Saint Venant (1843) and George Gabriel Stokes (1845) derived these equation based on the relationship between stress and rate-of-strain (this approach is presented in this book).

Navier-Stokes equations are non-linear and there are more than one possible solution in many cases (if not most cases) e.g. the solution is not unique. A discussion about the “regular” solution is present and a brief discussion about limitations when the solution is applicable. Later in the Chapters on Real Fluid and Turbulence, with a presentation of the “non-regular” solutions will be presented with the associated issues of stability. However even for the “regular” solution the mathematics is very complex. One of the approaches is to reduce the equations by eliminating the viscosity effects. The equations without the viscosity effects are referred to as the ideal flow equations (Euler Equations) which will be discussed in the next chapter. The concepts

---

<sup>1</sup>Which can be view as complementary analysis to the integral analysis.

of the Add Mass and the Add Force, which are easier to discuss when the viscosity is ignored, and will be presented in the Ideal Flow chapter. It has to be pointed out that the Add Mass and Add Force appear regardless to the viscosity. Historically, complexity of the equations, on one hand, leads to approximations and consequently to the ideal flow approximation (equations) and on the other hand experimental solutions of Navier–Stokes equations. The connection between these two ideas or fields was done via introduction of the boundary layer theory by Prandtl which will be discussed as well.

Even for simple situations, there are cases when complying with the boundary conditions leads to a discontinuity (shock or choked flow). These equations cannot satisfy the boundary conditions in other cases and in way the fluid pushes the boundary condition(s) further downstream (choked flow). These issues are discussed in Open Channel Flow and Compressible Flow chapters. Sometimes, the boundary conditions create instability which alters the boundary conditions itself which is known as Interfacial instability. The choked flow is associated with a single phase flow (even the double choked flow) while the Interfacial instability associated with the Multi–Phase flow. This phenomenon is presented in Multi–phase chapter and briefly discussed in this chapter.

### 8.2 Mass Conservation

Fluid flows into and from a three dimensional infinitesimal control volume depicted in Figure 8.1. At a specific time this control volume can be viewed as a system. The mass conservation for this infinitesimal small system is zero thus

$$\frac{D}{Dt} \int_V \rho dV = 0 \quad (8.1)$$

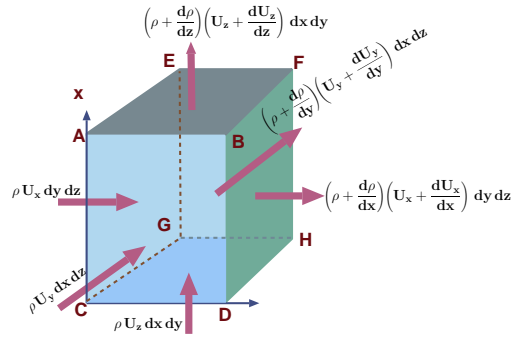

Fig. -8.1. The mass balance on the infinitesimal control volume.

However for a control volume using Reynolds Transport Theorem (RTT), the following can be written

$$\frac{D}{Dt} \int_V \rho dV = \frac{d}{dt} \int_V \rho dV + \int_A U_{rn} \rho dA = 0 \quad (8.2)$$

For a constant control volume, the derivative can enter into the integral (see also for the divergence theorem in the appendix A.1.2) on the right hand side and hence

$$\overbrace{\int_V \frac{d\rho}{dt} dV}^{\frac{d\rho}{dt} dV} + \int_A U_{rn} \rho dA = 0 \quad (8.3)$$

The first term in equation (8.3) for the infinitesimal volume is expressed, neglecting higher order derivatives, as

$$\int_V \frac{d\rho}{dt} dV = \frac{d\rho}{dt} \overbrace{dx dy dz}^{dV} + f \overbrace{\left(\frac{d^2\rho}{dt^2}\right)}^{\sim 0} + \dots \quad (8.4)$$

The second term in the LHS of equation (8.2) is expressed<sup>2</sup> as

$$\int_A U_{rn} \rho dA = \overbrace{dy dz}^{dA_{yz}} [(\rho U_x)|_x - (\rho U_x)|_{x+dx}] + \overbrace{dx dz}^{dA_{xz}} [(\rho U_y)|_y - (\rho U_y)|_{y+dy}] + \overbrace{dx dy}^{dA_{xy}} [(\rho U_z)|_z - (\rho U_z)|_{z+dz}] \quad (8.5)$$

The difference between point  $x$  and  $x + dx$  can be obtained by developing Taylor series as

$$(\rho U_x)|_{x+dx} = (\rho U_x)|_x + \left. \frac{\partial(\rho U_x)}{\partial x} \right|_x dx \quad (8.6)$$

The same can be said for the  $y$  and  $z$  coordinates. It also can be noticed that, for example, the operation, in the  $x$  coordinate, produces additional  $dx$  thus a infinitesimal volume element  $dV$  is obtained for all directions. The combination can be divided by  $dx dy dz$  and simplified by using the definition of the partial derivative in the regular process to be

$$\int_A U_{rn} \rho dA = - \left[ \frac{\partial(\rho U_x)}{\partial x} + \frac{\partial(\rho U_y)}{\partial y} + \frac{\partial(\rho U_z)}{\partial z} \right] \quad (8.7)$$

Combining the first term with the second term results in the continuity equation in Cartesian coordinates as

Continuity in Cartesian Coordinates

$$\frac{\partial\rho}{\partial t} + \frac{\partial\rho U_x}{\partial x} + \frac{\partial\rho U_y}{\partial y} + \frac{\partial\rho U_z}{\partial z} = 0 \quad (8.8)$$

### Cylindrical Coordinates

The same equation can be derived in cylindrical coordinates. The net mass change, as depicted in Figure 8.2, in the control volume is

$$d\dot{m} = \frac{\partial\rho}{\partial t} \overbrace{dr dz r d\theta}^{dv} \quad (8.9)$$

<sup>2</sup>Note that sometime the notation  $dA_{yz}$  also refers to  $dA_x$ .

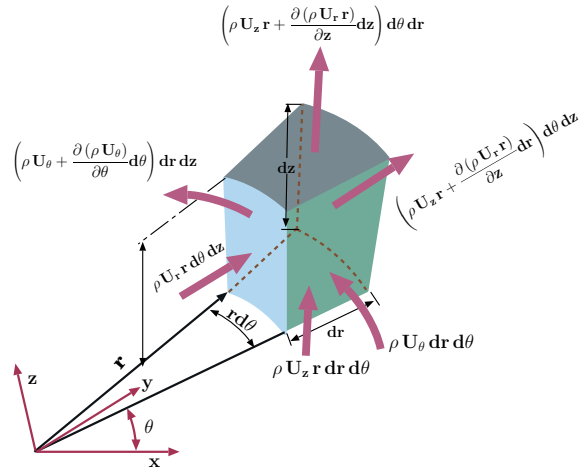

Fig. -8.2. The mass conservation in cylindrical coordinates.

The net mass flow out or in the  $\hat{r}$  direction has an additional term which is the area change compared to the Cartesian coordinates. This change creates a different differential equation with additional complications. The change is

$$\left( \begin{array}{c} \text{flux in } r \\ \text{direction} \end{array} \right) = d\theta dz \left( r \rho U_r - \left( r \rho U_r + \frac{\partial \rho U_r r}{\partial r} dr \right) \right) \quad (8.10)$$

The net flux in the  $r$  direction is then

$$\left( \begin{array}{c} \text{net flux in the} \\ r \text{ direction} \end{array} \right) = d\theta dz \frac{\partial \rho U_r r}{\partial r} dr \quad (8.11)$$

Note<sup>3</sup> that the  $r$  is still inside the derivative since it is a function of  $r$ , e.g. the change of  $r$  with  $r$ . In a similar fashion, the net flux in the  $z$  coordinate be written as

$$\text{net flux in } z \text{ direction} = r d\theta dr \frac{\partial (\rho U_z)}{\partial z} dz \quad (8.12)$$

The net change in the  $\theta$  direction is then

$$\text{net flux in } \theta \text{ direction} = dr dz \frac{\partial \rho U_\theta}{\partial \theta} d\theta \quad (8.13)$$

Combining equations (8.11)–(8.13) and dividing by infinitesimal control volume,  $dr r d\theta dz$ , results in

$$\left( \begin{array}{c} \text{total} \\ \text{net flux} \end{array} \right) = - \left( \frac{1}{r} \frac{\partial (\rho U_r r)}{\partial r} + \frac{\partial \rho U_z r}{\partial z} + \frac{\partial \rho U_\theta}{\partial \theta} \right) \quad (8.14)$$

<sup>3</sup>The mass flow is  $\rho U_r r d\theta dz$  at  $r$  point. Expansion to Taylor series  $\rho U_r r d\theta dz|_{r+dr}$  is obtained by the regular procedure. The mass flow at  $r + dr$  is  $\rho U_r r d\theta dz|_r + d/dr (\rho U_r r d\theta dz) dr + \dots$ . Hence, the  $r$  is “trapped” in the derivative.

Combining equation (8.14) with the change in the control volume (8.9) divided by infinitesimal control volume,  $dr r d\theta dz$  yields

$$\frac{\partial \rho}{\partial t} + \frac{1}{r} \frac{\partial (r \rho U_r)}{\partial r} + \frac{1}{r} \frac{\partial \rho U_\theta}{\partial \theta} + \frac{\partial \rho U_z}{\partial z} = 0 \quad (8.15)$$

Carrying similar operations for the spherical coordinates, the continuity equation becomes

$$\frac{\partial \rho}{\partial t} + \frac{1}{r^2} \frac{\partial (r^2 \rho U_r)}{\partial r} + \frac{1}{r \sin \theta} \frac{\partial (\rho U_\theta \sin \theta)}{\partial \theta} + \frac{1}{r \sin \theta} \frac{\partial \rho U_\phi}{\partial z} = 0 \quad (8.16)$$

The continuity equations (8.8), (8.15) and (8.16) can be expressed in different coordinates. It can be noticed that the second part of these equations is the divergence (see the Appendix A.1.2 page 570). Hence, the continuity equation can be written in a general vector form as

$$\frac{\partial \rho}{\partial t} + \nabla \cdot (\rho \mathbf{U}) = 0 \quad (8.17)$$

— — — — — *Advance material can be skipped* — — — — —

The mass equation can be written in index notation for Cartesian coordinates. The index notation really does not add much to the scientific understanding. However, this writing reduce the amount of writing and potentially can help the thinking about the problem or situation in more conceptual way. The mass equation (see in the appendix for more information on the index notation) written as

$$\frac{\partial \rho}{\partial t} + \frac{\partial (\rho U)_i}{\partial x_i} = 0 \quad (8.18)$$

Where  $i$  is is of the  $i$ ,  $j$ , and  $k$ <sup>4</sup>. Compare to equation (8.8). Again remember that the meaning of repeated index is summation.

— — — — — *End Advance material* — — — — —

The use of these equations is normally combined with other equations (momentum and or energy equations). There are very few cases where this equation is used on its own merit. For academic purposes, several examples are constructed here.

### 8.2.1 Mass Conservation Examples

Example 8.1:

A layer of liquid has an initial height of  $H_0$  with an uniform temperature of  $T_0$ . At

<sup>4</sup>notice the irony the second  $i$  is the direction and first  $i$  is for any one of direction  $x(i)$ ,  $y(j)$ , and  $z(k)$ .

time,  $t_0$ , the upper surface is exposed to temperature  $T_1$  (see Figure 8.3). Assume that

the actual temperature is exponentially approaches to a linear temperature profile as depicted in Figure 8.3. The density is a function of the temperature according to

$$\frac{T - T_0}{T_1 - T_0} = \alpha \left( \frac{\rho - \rho_0}{\rho_1 - \rho_0} \right) \quad (8.1.a)$$

where  $\rho_1$  is the density at the surface and where  $\rho_0$  is the density at the bottom. Assume that the velocity is only a function of the  $y$  coordinate. Calculate the velocity of the liquid. Assume that the velocity at the lower boundary is zero at all times. Neglect the mutual dependency of the temperature and the height.

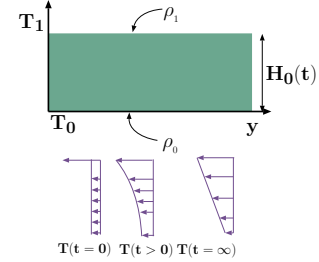

Fig. -8.3. Mass flow due to temperature difference for example 8.1

#### SOLUTION

The situation is unsteady state thus the unsteady state and one dimensional continuity equation has to be used which is

$$\frac{\partial \rho}{\partial t} + \frac{\partial (\rho U_y)}{\partial y} = 0 \quad (8.1.b)$$

with the boundary condition of zero velocity at the lower surface  $U_y(y = 0) = 0$ . The expression that connects the temperature with the space for the final temperature as

$$\frac{T - T_0}{T_1 - T_0} = \alpha \frac{H_0 - y}{H_0} \quad (8.1.c)$$

The exponential decay is  $(1 - e^{-\beta t})$  and thus the combination (with equation (8.1.a)) is

$$\frac{\rho - \rho_0}{\rho_1 - \rho_0} = \alpha \frac{H_0 - y}{H_0} (1 - e^{-\beta t}) \quad (8.1.d)$$

Equation (8.1.d) relates the temperature with the time and the location was given in the question (it is not the solution of any model). It can be noticed that the height  $H_0$  is a function of time. For this question, it is treated as a constant. Substituting the density,  $\rho$ , as a function of time into the governing equation (8.1.b) results in

$$\underbrace{\alpha \beta \left( \frac{H_0 - y}{H_0} \right) e^{-\beta t}}_{\frac{\partial \rho}{\partial t}} + \underbrace{\frac{\partial \left( U_y \alpha \frac{H_0 - y}{H_0} (1 - e^{-\beta t}) \right)}{\partial y}}_{\frac{\partial (\rho U_y)}{\partial y}} = 0 \quad (8.1.e)$$

Equation (8.1.e) is first order ODE with the boundary condition  $U_y(y = 0) = 0$  which can be arranged as

$$\frac{\partial \left( U_y \alpha \frac{H_0 - y}{H_0} (1 - e^{-\beta t}) \right)}{\partial y} = -\alpha \beta \left( \frac{H_0 - y}{H_0} \right) e^{-\beta t} \quad (8.1.f)$$

$U_y$  is a function of the time but not  $y$ . Equation (8.1.f) holds for any time and thus, it can be treated for the solution of equation (8.1.f) as a constant<sup>5</sup>. Hence, the integration with respect to  $y$  yields

$$\left( U_y \alpha \frac{H_0 - y}{H_0} (1 - e^{-\beta t}) \right) = -\alpha \beta \left( \frac{2H_0 - y}{2H_0} \right) e^{-\beta t} y + c \quad (8.1.g)$$

Utilizing the boundary condition  $U_y(y = 0) = 0$  yields

$$\left( U_y \alpha \frac{H_0 - y}{H_0} (1 - e^{-\beta t}) \right) = -\alpha \beta \left( \frac{2H_0 - y}{2H_0} \right) e^{-\beta t} (y - 1) \quad (8.1.h)$$

or the velocity is

$$U_y = \beta \left( \frac{2H_0 - y}{2(H_0 - y)} \right) \frac{e^{-\beta t}}{(1 - e^{-\beta t})} (1 - y) \quad (8.1.i)$$

It can be noticed that indeed the velocity is a function of the time and space  $y$ .

---

End Solution

---

### 8.2.2 Simplified Continuity Equation

A simplified equation can be obtained for a steady state in which the transient term is eliminated as (in a vector form)

$$\nabla \cdot (\rho \mathbf{U}) = 0 \quad (8.19)$$

If the fluid is incompressible then the governing equation is a volume conservation as

$$\nabla \cdot \mathbf{U} = 0 \quad (8.20)$$

Note that this equation appropriate only for a single phase case.

Example 8.2:

*In many coating processes a thin film is created by a continuous process in which liquid injected into a moving belt which carries the material out as exhibited in Figure 8.4.*

---

<sup>5</sup>Since the time can be treated as a constant for  $y$  integration.

The temperature and mass transfer taking place which reduces (or increases) the thickness of the film. For this example, assume that no mass transfer occurs or can be neglected and the main mechanism is heat transfer. Assume that the film temperature is only a function of the distance from the extraction point. Calculate the film velocity field if the density is a function of the temperature. The relationship between the density and the temperature is linear as

$$\frac{\rho - \rho_\infty}{\rho_0 - \rho_\infty} = \alpha \left( \frac{T - T_\infty}{T_0 - T_\infty} \right) \quad (8.11.a)$$

State your assumptions.

#### SOLUTION

This problem is somewhat similar to Example 8.1<sup>6</sup>, however it can be considered as steady state. At any point the governing equation in coordinate system that moving with the belt is

$$\frac{\partial(\rho U_x)}{\partial x} + \frac{\partial(\rho U_y)}{\partial y} = 0 \quad (8.11.b)$$

At first, it can be assumed that the material moves with the belt in the  $x$  direction in the same velocity. This assumption is consistent with the first solution (no stability issues). If the frame of reference was moving with the belt then there is only velocity component in the  $y$  direction<sup>7</sup>. Hence equation (8.11.b) can be written as

$$U_x \frac{\partial \rho}{\partial x} = - \frac{\partial(\rho U_y)}{\partial y} \quad (8.11.c)$$

Where  $U_x$  is the belt velocity.

See the resembles to equation (8.1.b). The solution is similar to the previous Example 8.1 for a general function  $T = F(x)$ .

$$\frac{\partial \rho}{\partial x} = \frac{\alpha}{U_x} \frac{\partial F(x)}{\partial x} (\rho_0 - \rho_\infty) \quad (8.11.d)$$

Substituting this relationship in equation (8.11.d) into the governing equation results in

$$\frac{\partial U_y \rho}{\partial y} = \frac{\alpha}{U_x} \frac{\partial F(x)}{\partial x} (\rho_0 - \rho_\infty) \quad (8.11.e)$$

<sup>6</sup>The presentation of one dimension time dependent problem to two dimensions problems can be traced to heat and mass transfer problems. One of the early pioneers who suggest this idea is Higbie which Higbie's equation named after him. Higbie's idea which was rejected by the scientific establishment. He spend the rest of his life to proof it and ending in a suicide. On personal note, this author Master thesis is extension Higbie's equation.

<sup>7</sup>In reality this assumption is correct only in a certain range. However, the discussion about this point is beyond the scope of this section.

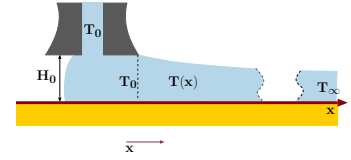

Fig. -8.4. Mass flow in coating process for example 8.2.



The density is expressed by equation (8.II.a) and thus

$$U_y = \frac{\alpha}{\rho U_x} \frac{\partial F(x)}{\partial x} (\rho_0 - \rho_\infty) y + c \quad (8.II.f)$$

Notice that  $\rho$  could “come” out of the derivative (why?) and move into the RHS. Applying the boundary condition  $U_y(t=0) = 0$  results in

$$U_y = \frac{\alpha}{\rho(x) U_x} \frac{\partial F(x)}{\partial x} (\rho_0 - \rho_\infty) y \quad (8.II.g)$$

---

End Solution

---

Example 8.3:

The velocity in a two dimensional field is assumed to be in a steady state. Assume that the density is constant and calculate the vertical velocity ( $y$  component) for the following  $x$  velocity component.

$$U_x = a x^2 + b y^2 \quad (8.III.a)$$

Next, assume the density is also a function of the location in the form of

$$\rho = m e^{x+y} \quad (8.III.b)$$

Where  $m$  is constant. Calculate the velocity field in this case.

#### SOLUTION

The flow field must comply with the mass conservation (8.20) thus

$$2 a x + \frac{\partial U_y}{\partial y} = 0 \quad (8.III.c)$$

Equation (8.III.c) is an ODE with constant coefficients. It can be noted that  $x$  should be treated as a constant parameter for the  $y$  coordinate integration. Thus,

$$U_y = - \int 2 a x + f(x) = -2 x y + f(x) \quad (8.III.d)$$

The integration constant in this case is not really a constant but rather an arbitrary function of  $x$ . Notice the symmetry of the situation. The velocity,  $U_x$  has also arbitrary function in the  $y$  component.

For the second part equation (8.19) is applicable and used as

$$\frac{\partial (a x^2 + b y^2) (m e^{x+y})}{\partial x} + \frac{\partial U_y (m e^{x+y})}{\partial y} = 0 \quad (8.III.e)$$

Taking the derivative of the first term while moving the second part to the other side results in

$$a \left( 2 x + x^2 + \frac{b}{a} y^2 \right) e^{x+y} = - (e^{x+y}) \left( \frac{\partial U_y}{\partial y} + U_y \right) \quad (8.III.f)$$

The exponent can be canceled to further simplify the equation (8.III.f) and switching sides to be

$$\left(\frac{\partial U_y}{\partial y} + U_y\right) = -a \left(2x + x^2 + \frac{b}{a} y^2\right) \quad (8.III.g)$$

Equation (8.III.g) is a first order ODE that can be solved by combination of the homogeneous solution with the private solution (see for an explanation in the Appendix). The homogeneous equation is

$$\left(\frac{\partial U_y}{\partial y} + U_y\right) = 0 \quad (8.III.h)$$

The solution for (8.III.h) is  $U_y = c e^{-y}$  (see for an explanation in the appendix). The private solution is

$$U_y|_{private} = (-b(y^2 - 2y + 2) - ax^2 - 2ax) \quad (8.III.i)$$

The total solution is

$$U_y = c e^{-y} + (-b(y^2 - 2y + 2) - ax^2 - 2ax) \quad (8.III.j)$$

---

End Solution

---

**Example 8.4:**

*Can the following velocities co-exist*

$$U_x = (xt)^2 z \quad U_y = (xt) + (yt) + (zt) \quad U_z = (xt) + (yt) + (zt) \quad (8.IV.a)$$

*in the flow field. Is the flow is incompressible? Is the flow in a steady state condition?*

SOLUTION

Whether the solution is in a steady state or not can be observed from whether the velocity contains time component. Thus, this flow field is not steady state since it contains time component. This continuity equation is checked if the flow incompressible (constant density). The derivative of each component are

$$\frac{\partial U_x}{\partial x} = t^2 z \quad \frac{\partial U_y}{\partial y} = t \quad \frac{\partial U_z}{\partial z} = t \quad (8.IV.b)$$

Hence the gradient or the combination of these derivatives is

$$\nabla U = t^2 z + 2t \quad (8.IV.c)$$

The divergence isn't zero thus this flow, if it exist, must be compressible flow. This flow can exist only for a limit time since over time the divergence is unbounded (a source must exist).

---

End Solution

---

Example 8.5:

Find the density as a function of the time for a given one dimensional flow with  $U_x = x e^{5\alpha y} (\cos(\alpha t))$ . The initial density is  $\rho(t=0) = \rho_0$ .

SOLUTION

This problem is one dimensional unsteady state and for a compressible substance. Hence, the mass conservation is reduced only for one dimensional form as

$$\frac{\partial \rho}{\partial t} + \frac{\partial (U_x \rho)}{\partial x} = 0 \quad (8.V.a)$$

Mathematically speaking, this kind of presentation is possible. However physically there are velocity components in  $y$  and  $z$  directions. In this problem, these physical components are ignored for academic reasons. Equation (8.V.a) is first order partial differential equation which can be converted to an ordinary differential equations when the velocity component,  $U_x$ , is substituted. Using,

$$\frac{\partial U_x}{\partial x} = e^{5\alpha y} (\cos(\alpha t)) \quad (8.V.b)$$

Substituting equation (8.V.b) into equation (8.V.a) and noticing that the density,  $\rho$ , is a function of  $x$  results of

$$\frac{\partial \rho}{\partial t} = -\rho x e^{5\alpha y} (\cos(\alpha t)) - \frac{\partial \rho}{\partial x} e^{5\alpha y} (\cos(\alpha t)) \quad (8.V.c)$$

Equation (8.V.c) can be separated to yield

$$\overbrace{\frac{1}{\cos(\alpha t)} \frac{\partial \rho}{\partial t}}^{f(t)} = \overbrace{-\rho x e^{5\alpha y} - \frac{\partial \rho}{\partial x} e^{5\alpha y}}^{f(y)} \quad (8.V.d)$$

A possible solution is when the left and the right hand sides are equal to a constant. In that case the left hand side is

$$\frac{1}{\cos(\alpha t)} \frac{\partial \rho}{\partial t} = c_1 \quad (8.V.e)$$

The solution of equation (8.V.e) is reduced to ODE and its solution is

$$\rho = \frac{c_1 \sin(\alpha t)}{\alpha} + c_2 \quad (8.V.f)$$

The same can be done for the right hand side as

$$\rho x e^{5\alpha y} + \frac{\partial \rho}{\partial x} e^{5\alpha y} = c_1 \quad (8.V.g)$$

The term  $e^{5\alpha y}$  is always positive, real value, and independent of  $y$  thus equation (8.V.g) becomes

$$\rho x + \frac{\partial \rho}{\partial x} = \frac{c_1}{e^{5\alpha y}} = c_3 \quad (8.V.h)$$

Equation (8.V.h) is a constant coefficients first order ODE which its solution discussed extensively in the appendix. The solution of (8.V.h) is given by

$$\rho = e^{-\frac{x^2}{2}} \left( c - \frac{\overbrace{\sqrt{\pi} i c_3 \operatorname{erf}\left(\frac{ix}{\sqrt{2}}\right)}^{\text{impossible solution}}}{\sqrt{2}} \right) \quad (8.V.i)$$

which indicates that the solution is a complex number thus the constant,  $c_3$ , must be zero and thus the constant,  $c_1$  vanishes as well and the solution contain only the homogeneous part and the private solution is dropped

$$\rho = c_2 e^{-\frac{x^2}{2}} \quad (8.V.j)$$

The solution is the multiplication of equation (8.V.j) by (8.V.f) transferred to

$$\rho = c_2 e^{-\frac{x^2}{2}} \left( \frac{c_1 \sin(\alpha t)}{\alpha} + c_2 \right) \quad (8.V.k)$$

Where the constant,  $c_2$ , is an arbitrary function of the  $y$  coordinate.

---

End Solution

---

## 8.3 Conservation of General Quantity

### 8.3.1 Generalization of Mathematical Approach for Derivations

In this section a general approach for the derivations for conservation of any quantity e.g. scalar, vector or tensor, are presented. Suppose that the property  $\phi$  is under a study which is a function of the time and location as  $\phi(x, y, z, t)$ . The total amount of quantity that exist in arbitrary system is

$$\Phi = \int_{sys} \phi \rho dV \quad (8.21)$$

Where  $\Phi$  is the total quantity of the system which has a volume  $V$  and a surface area of  $A$  which is a function of time. A change with time is

$$\frac{D\Phi}{Dt} = \frac{D}{Dt} \int_{sys} \phi \rho dV \quad (8.22)$$

Using RTT to change the system to a control volume (see equation (5.33)) yields

$$\frac{D}{Dt} \int_{sys} \phi \rho dV = \frac{d}{dt} \int_{cv} \phi \rho dV + \int_A \rho \phi \mathbf{U} \cdot d\mathbf{A} \quad (8.23)$$

The last term on the RHS can be converted using the divergence theorem (see the appendix<sup>8</sup>) from a surface integral into a volume integral (alternatively, the volume integral can be changed to the surface integral) as

$$\int_A \rho \phi \mathbf{U} \cdot d\mathbf{A} = \int_V \nabla \cdot (\rho \phi \mathbf{U}) dV \quad (8.24)$$

Substituting equation (8.24) into equation (8.23) yields

$$\frac{D}{Dt} \int_{sys} \phi \rho dV = \frac{d}{dt} \int_{cv} \phi \rho dV + \int_{cv} \nabla \cdot (\rho \phi \mathbf{U}) dV \quad (8.25)$$

Since the volume of the control volume remains independent of the time, the derivative can enter into the integral and thus combining the two integrals on the RHS results in

$$\frac{D}{Dt} \int_{sys} \phi \rho dV = \int_{cv} \left( \frac{d(\phi \rho)}{dt} + \nabla \cdot (\rho \phi \mathbf{U}) \right) dV \quad (8.26)$$

The definition of equation (8.21) LHS can be changed to simply the derivative of  $\Phi$ . The integral is carried over arbitrary system. For an infinitesimal control volume the change is

$$\frac{D\Phi}{Dt} \cong \left( \frac{d(\phi \rho)}{dt} + \nabla \cdot (\rho \phi \mathbf{U}) \right) \overbrace{dx dy dz}^{dV} \quad (8.27)$$

### 8.3.2 Examples of Several Quantities

#### 8.3.2.1 The General Mass Time Derivative

Using  $\phi = 1$  is the same as dealing with the mass conservation. In that case  $\frac{D\Phi}{Dt} = \frac{D\rho}{Dt}$  which is equal to zero as

$$\int \left( \frac{d \left( \overbrace{1}^{\phi} \rho \right)}{dt} + \nabla \cdot \left( \rho \overbrace{1}^{\phi} \mathbf{U} \right) \right) \overbrace{dx dy dz}^{dV} = 0 \quad (8.28)$$

Using equation (8.21) leads to

$$\frac{D\rho}{Dt} = 0 \longrightarrow \frac{\partial \rho}{\partial t} + \nabla \cdot (\rho \mathbf{U}) = 0 \quad (8.29)$$

Equation (8.29) can be rearranged as

$$\frac{\partial \rho}{\partial t} + \mathbf{U} \nabla \cdot \rho + \rho \nabla \cdot \mathbf{U} = 0 \quad (8.30)$$

<sup>8</sup>These integrals are related to RTT. Basically the divergence theorem relates the flow out (or) in and the sum of the all the changes inside the control volume.

Equation (8.30) can be further rearranged so derivative of the density is equal the divergence of velocity as

$$\frac{1}{\rho} \left( \overbrace{\frac{\partial \rho}{\partial t} + \mathbf{U} \cdot \nabla \rho}^{\text{substantial derivative}} \right) = -\nabla \cdot \mathbf{U} \quad (8.31)$$

Equation (8.31) relates the density rate of change or the volumetric change to the velocity divergence of the flow field. The term in the bracket LHS is referred in the literature as substantial derivative. The substantial derivative represents the change rate of the density at a point which moves with the fluid.

### Acceleration Direct Derivations

One of the important points is to find the fluid particles acceleration. A fluid particle velocity is a function of the location and time. Therefore, it can be written that

$$\mathbf{U}(x, y, z, t) = U_x(x, y, z, t) \hat{i} + U_y(x, y, z, t) \hat{j} + U_z(x, y, z, t) \hat{k} \quad (8.32)$$

Therefore the acceleration will be

$$\frac{D\mathbf{U}}{Dt} = \frac{dU_x}{dt} \hat{i} + \frac{dU_y}{dt} \hat{j} + \frac{dU_z}{dt} \hat{k} \quad (8.33)$$

The velocity components are a function of four variables,  $(x, y, z, \text{ and } t)$ , and hence

$$\frac{DU_x}{Dt} = \frac{\partial U_x}{\partial t} \overbrace{\frac{dt}{dt}}^{=1} + \frac{\partial U_x}{\partial x} \overbrace{\frac{dx}{dt}}^{U_x} + \frac{\partial U_x}{\partial y} \overbrace{\frac{dy}{dt}}^{U_y} + \frac{\partial U_x}{\partial z} \overbrace{\frac{dz}{dt}}^{U_z} \quad (8.34)$$

The acceleration in the  $x$  can be written as

$$\frac{DU_x}{Dt} = \frac{\partial U_x}{\partial t} + U_x \frac{\partial U_x}{\partial x} + U_y \frac{\partial U_x}{\partial y} + U_z \frac{\partial U_x}{\partial z} = \frac{\partial U_x}{\partial t} + (\mathbf{U} \cdot \nabla) U_x \quad (8.35)$$

The same can be developed to the other two coordinates which can be combined (in a vector form) as

$$\frac{d\mathbf{U}}{dt} = \frac{\partial \mathbf{U}}{\partial t} + (\mathbf{U} \cdot \nabla) \mathbf{U} \quad (8.36)$$

or in a more explicit form as

$$\frac{d\mathbf{U}}{dt} = \overbrace{\frac{\partial \mathbf{U}}{\partial t}}^{\text{local acceleration}} + \overbrace{\mathbf{U} \frac{\partial \mathbf{U}}{\partial x} + \mathbf{U} \frac{\partial \mathbf{U}}{\partial y} + \mathbf{U} \frac{\partial \mathbf{U}}{\partial z}}^{\text{convective acceleration}} \quad (8.37)$$

The time derivative referred in the literature as the local acceleration which vanishes when the flow is in a steady state. While the flow is in a steady state there is only convective acceleration of the flow. The flow in a nozzle is an example to flow at steady state but yet has acceleration which flow with a very low velocity can achieve a supersonic flow.

### 8.4 Momentum Conservation

The relationship among the shear stress various components have to be established. The stress is a relationship between the force and area it is acting on or force divided by the area (division of vector by a vector). This division creates a tensor which the physical meaning will be explained here (the mathematical explanation can be found in the mathematical appendix of the book). The area has a direction or orientation which control the results of this division. So it can be written that

$$\boldsymbol{\tau} = f(\mathbf{F}, \mathbf{A}) \tag{8.38}$$

It was shown that in a static case (or in better words, when the shear stresses are absent) it was written

$$\boldsymbol{\tau} = -P\hat{n} \tag{8.39}$$

It also was shown that the pressure has to be continuous. However, these stresses that act on every point and have three components on every surface and depend on the surface orientation. A common approach is to collect the stress in a “standard” orientation and then if needed the stresses can be reorientated to a new direction. The transformation is available because the “standard” surface can be transformed using trigonometrical functions. In Cartesian coordinates on surface in the  $x$  direction the stresses are

$$\boldsymbol{\tau}^{(x)} = \begin{matrix} \tau_{xx} & \tau_{xy} & \tau_{xz} \end{matrix} \tag{8.40}$$

where  $\tau_{xx}$  is the stress acting on surface  $x$  in the  $x$  direction, and  $\tau_{xy}$  is the stress acting on surface  $x$  in the  $y$  direction, similarly for  $\tau_{xz}$ . The notation  $\boldsymbol{\tau}^{(x_i)}$  is used to denote the stresses on  $x_i$  surface. It can be noticed that no mathematical symbols are written between the components. The reason for this omission is that there is no physical meaning for it<sup>9</sup>. Similar “vectors” exist for the  $y$  and  $z$  coordinates which can be written in a matrix form

$$\boldsymbol{\tau} = \begin{pmatrix} \tau_{xx} & \tau_{xy} & \tau_{xz} \\ \tau_{yx} & \tau_{yy} & \tau_{yz} \\ \tau_{zx} & \tau_{zy} & \tau_{zz} \end{pmatrix} \tag{8.41}$$

Suppose that a straight angle tetrahedron is under stress as shown in Figure 8.5. The forces balance in the  $x$  direction excluding the slanted surface is

$$F_x = -\tau_{yx}\delta A_y - \tau_{xx}\delta A_x - \tau_{zx}\delta A_z \tag{8.42}$$

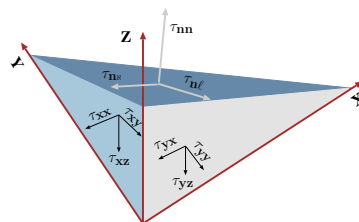

Fig. -8.5. Stress diagram on a tetrahedron shape.

<sup>9</sup>It can be argue that there is physical meaning that does not significant to the understanding of the subject.

where  $\delta A_y$  is the surface area of the tetrahedron in the  $y$  direction,  $\delta A_x$  is the surface area of the tetrahedron in the  $x$  direction and  $\delta A_z$  is the surface area of the tetrahedron in the  $z$  direction. The opposing forces which acting on the slanted surface in the  $x$  direction are

$$F_x = \delta A_n \left( \tau_{nn} \hat{n} \cdot \hat{i} - \tau_{n\ell} \hat{\ell} \cdot \hat{i} - \tau_{n\hat{N}} \hat{\hat{N}} \cdot \hat{i} \right) \quad (8.43)$$

Where here  $\hat{\hat{N}}$ ,  $\hat{\ell}$  and  $\hat{n}$  are the local unit coordinates on  $n$  surface the same can be written in the  $x$ , and  $z$  directions. The transformation matrix is then

$$\begin{pmatrix} F_x \\ F_y \\ F_z \end{pmatrix} = \begin{pmatrix} \hat{n} \cdot \hat{i} & \hat{\ell} \cdot \hat{i} & \hat{\hat{N}} \cdot \hat{i} \\ \hat{n} \cdot \hat{j} & \hat{\ell} \cdot \hat{j} & \hat{\hat{N}} \cdot \hat{j} \\ \hat{n} \cdot \hat{k} & \hat{\ell} \cdot \hat{k} & \hat{\hat{N}} \cdot \hat{k} \end{pmatrix} \delta A_n \quad (8.44)$$

When the tetrahedron is shrunk to a point relationship of the stress on the two sides can be expanded by Taylor series and keeping the first derivative. If the first derivative is neglected (tetrahedron is without acceleration) the two sides are related as

$$-\tau_{yx} \delta A_y - \tau_{xx} \delta A_x - \tau_{zx} \delta A_z = \delta A_n \left( \tau_{nn} \hat{n} \cdot \hat{i} - \tau_{n\ell} \hat{\ell} \cdot \hat{i} - \tau_{n\hat{N}} \hat{\hat{N}} \cdot \hat{i} \right) \quad (8.45)$$

The same can be done for  $y$  and  $z$  directions. The areas are related to each other through angles. These relationships provide the transformation for the different orientations which depends only angles of the orientations. This matrix is referred to as stress tensor and as it can be observed has nine terms.

### The Symmetry of the Stress Tensor

A small liquid cubical has three possible rotation axes. Here only one will be discussed the same conclusions can be drawn on the other direction. The cubical rotation can involve two parts: one distortion and one rotation<sup>10</sup>. A finite angular distortion of infinitesimal cube requires an infinite shear which required for infinite moment. Hence, the rotation of the infinitesimal fluid cube can be viewed as it is done almost as a solid body rotation. Balance of momentum around the  $z$  direction shown in Figure 8.6 is

$$M_z = I_{zz} \frac{d\theta}{dt} \quad (8.46)$$

Where  $M_z$  is the cubic moment around the cubic center and  $I_{zz}$ <sup>11</sup> is the moment of inertia around that center. The momentum can be asserted by the shear stresses which act on it. The shear stress at point  $x$  is  $\tau_{xy}$ . However, the shear stress at point  $x + dx$  is

$$\tau_{xy}|_{x+dx} = \tau_{xy} + \frac{d\tau_{xy}}{dx} dx \quad (8.47)$$

<sup>10</sup>For infinitesimal change the lines can be approximated as straight.

<sup>11</sup>See for the derivations in Example 3.5 for moment of inertia.



The same can be said for  $\tau_{yx}$  for  $y$  direction. The clarity of this analysis can be improved if additional terms are taken, yet it turn out that the results will be the same. The normal body force (gravity) acts through the cubic center of gravity. The moment that created by this action can be neglected (the changes are insignificant). However, for cases that body force, such as the magnetic fields, can create torque. For simplicity and generality, it is assumed that the external body force exerts a torque  $G_T$  per unit volume at the specific location. The body force can exert torque is due to the fact that the body force is not uniform and hence not act through the mass center.

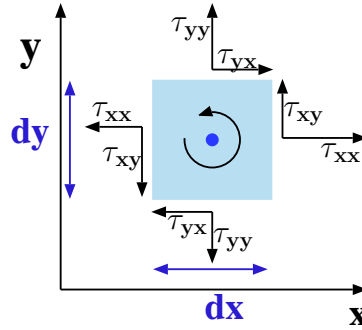

Fig. -8.6. Diagram to analysis the shear stress tensor.

— — — — — Advance material can be skipped — — — — —

The shear stress in the surface direction potentially can result in the torque due to the change in the shear stress<sup>12</sup>. For example,  $\tau_{xx}$  at  $x$  can be expanded as a linear function

$$\tau_{xx} = \tau_{xx}|_y + \frac{d\tau_{xx}}{dy} \Big|_y \eta \tag{8.48}$$

where  $\eta$  is the local coordinate in the  $y$  direction starting at  $y$  and “mostly used” between  $y < \eta < y + dy$ .

The moment that results from this shear force (clockwise positive) is

$$\int_y^{y+dy} \tau_{xx}(\eta) \left( \eta - \frac{dy}{2} \right) d\eta \tag{8.49}$$

Substituting (8.48) into (8.49) results

$$\int_y^{y+dy} \left( \tau_{xx}|_y + \frac{d\tau_{xx}}{dy} \Big|_y \eta \right) \left( \eta - \frac{dy}{2} \right) d\eta \tag{8.50}$$

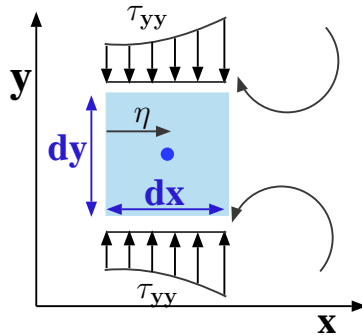

Fig. -8.7. The shear stress creating torque.

The integral of (8.50) isn't zero (non symmetrical function around the center of integration). The reason that this term is

<sup>12</sup>This point bother this author in the completeness of the proof. It can be ignored, but provided to those who wonder why body forces can contribute to the torque while pressure, even though varied, does not. This point is for self convincing since it deals with a “strange” and problematic “animals” of integral of infinitesimal length.

neglected because on the other face of the cubic contributes an identical term but in the opposing direction (see Figure 8.6).

— — — — — *End Advance material* — — — — —

The net torque in the z-direction around the particle's center would then be

$$\begin{aligned} (\tau_{yx}) \frac{dx dy dz}{2} - \left( \tau_{yx} + \frac{\partial \tau_{yx}}{\partial x} \right) \frac{dx dy dz}{2} + (\tau_{xy}) \frac{dx dy dz}{2} - \\ \left( \tau_{xy} + \frac{\partial \tau_{xy}}{\partial x} \right) \frac{dx dy dz}{2} = \overbrace{\rho dx dy dz ((dx)^2 + (dy)^2)}^{I_{zz}} \frac{d\theta}{dt} \end{aligned} \quad (8.51)$$

The actual components which contribute to the moment are

$$G_T + \tau_{xy} - \tau_{xy} + \overbrace{\frac{\partial (\tau_{yx} - \tau_{xy})}{\partial y}}^{\cong 0} = \rho \overbrace{\frac{((dx)^2 + (dy)^2)}{12}}^{\cong 0} \frac{d\theta}{dt} \quad (8.52)$$

which means since that  $dx \rightarrow 0$  and  $dy \rightarrow 0$  that

$$G_T + \tau_{xy} = \tau_{yx} \quad (8.53)$$

This analysis can be done on the other two directions and hence the general conclusion is that

$$G_T + \tau_{ij} = \tau_{ji} \quad (8.54)$$

where  $i$  is one of  $x, y, z$  and the  $j$  is any of the other  $x, y, z$ <sup>13</sup>. For the case of  $G_T = 0$  the stress tensor becomes symmetrical. The gravity is a body force that is considered in many kind of calculations and this force cause a change in symmetry of the stress tensor. However, this change, for almost all practical purposes, can be neglected<sup>14</sup>. The magnetic body forces on the other hand are significant and have to be included in the calculations. If the body forces effect is neglected or do not exist in the problem then regardless the coordinate system orientation

$$\tau_{ij} = \tau_{ji} \quad (i \neq j) \quad (8.55)$$

## 8.5 Derivations of the Momentum Equation

Previously it was shown that equation (6.11) is equivalent to Newton second law for fluids. Equation (6.11) is also applicable for the small infinitesimal cubic. One direction of the vector equation will be derived for  $x$  Cartesian coordinate (see Figure 8.8). Later Newton second law will be used and generalized. For surface forces that acting on the

<sup>13</sup>The index notation is not the main mode of presentation in this book. However, since Potto Project books are used extensively and numerous people asked to include this notation it was added. It is believed that this notation should and can be used only after the physical meaning was "digested."

<sup>14</sup>In the Dimensional Analysis a discussion about this effect hopefully will be presented.

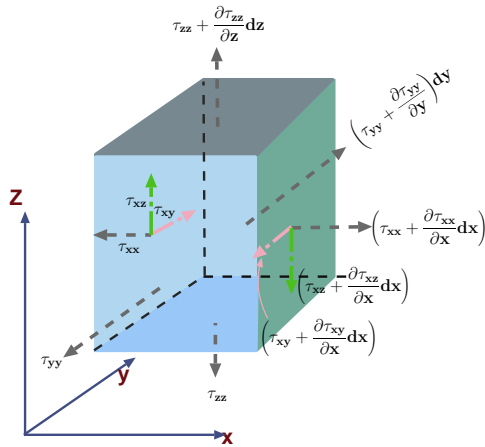

Fig. -8.8. The shear stress at different surfaces. All shear stress shown in surface  $x$  and  $x + dx$ .

cubic are surface forces, gravitation forces (body forces), and internal forces. The body force that acting on infinitesimal cubic in  $x$  direction is

$$\hat{i} \cdot \mathbf{f}_B = \mathbf{f}_{B_x} dx dy dz \tag{8.56}$$

The dot product yields a force in the directing of  $x$ . The surface forces in  $x$  direction on the  $x$  surface on are

$$f_{xx} = \tau_{xx}|_{x+dx} \times \overbrace{dy dz}^{dA_x} - \tau_{xx}|_x \times \overbrace{dy dz}^{dA_x} \tag{8.57}$$

The surface forces in  $x$  direction on the  $y$  surface on are

$$f_{xy} = \tau_{yx}|_{y+dy} \times \overbrace{dx dz}^{dA_y} - \tau_{yx}|_y \times \overbrace{dx dz}^{dA_y} \tag{8.58}$$

The same can be written for the  $z$  direction. The shear stresses can be expanded into Taylor series as

$$\tau_{ix}|_{i+di} = \tau_{ix} + \left. \frac{\partial (\tau_{ix})}{\partial i} \right|_i di + \dots \tag{8.59}$$

where  $i$  in this case is  $x, y,$  or  $z$ . Hence, the total net surface force results from the shear stress in the  $x$  direction is

$$f_x = \left( \frac{\partial \tau_{xx}}{\partial x} + \frac{\partial \tau_{yx}}{\partial y} + \frac{\partial \tau_{zx}}{\partial z} \right) dx dy dz \tag{8.60}$$

after rearrangement equations such as (8.57) and (8.58) transformed into

$$\overbrace{\frac{DU_x}{Dt} \rho dx dy dz}^{\text{internal forces}} = \overbrace{\left( \frac{\partial \tau_{xx}}{\partial x} + \frac{\partial \tau_{yx}}{\partial y} + \frac{\partial \tau_{zx}}{\partial z} \right) dx dy dz}^{\text{surface forces}} + \overbrace{f_{G_x} \rho dx dy dz}^{\text{body forces}} \quad (8.61)$$

equivalent equation (8.61) for  $y$  coordinate is

$$\rho \frac{DU_y}{Dt} = \left( \frac{\partial \tau_{xy}}{\partial x} + \frac{\partial \tau_{yy}}{\partial y} + \frac{\partial \tau_{zy}}{\partial z} \right) + \rho f_{G_y} \quad (8.62)$$

The same can be obtained for the  $z$  component

$$\rho \frac{DU_z}{Dt} = \left( \frac{\partial \tau_{xz}}{\partial x} + \frac{\partial \tau_{yz}}{\partial y} + \frac{\partial \tau_{zz}}{\partial z} \right) + \rho f_{G_z} \quad (8.63)$$

— — — — — *Advance material can be skipped* — — — — —

Generally the component momentum equation is as

$$\rho \frac{DU_i}{Dt} = \left( \frac{\partial \tau_{ii}}{\partial i} + \frac{\partial \tau_{ji}}{\partial j} + \frac{\partial \tau_{ki}}{\partial k} \right) + \rho f_{G_i} \quad (8.64)$$

— — — — — *End Advance material* — — — — —

Where  $i$  is the balance direction and  $j$  and  $k$  are two other coordinates. Equation (8.64) can be written in a vector form which combined all three components into one equation. The advantage of the vector form allows the usage of the different coordinates. The vector form is

$$\rho \frac{DU}{Dt} = \nabla \cdot \boldsymbol{\tau}^{(i)} + \rho \mathbf{f}_G \quad (8.65)$$

where here

$$\boldsymbol{\tau}^{(i)} = \tau_{ix} \hat{i} + \tau_{iy} \hat{j} + \tau_{iz} \hat{k}$$

is part of the shear stress tensor and  $i$  can be any of the  $x, y,$  or  $z$ .

Or in index (Einstein) notation as

$$\rho \frac{DU_i}{Dt} = \frac{\partial \tau_{ji}}{\partial x_i} + \rho f_{G_i} \quad (8.66)$$

— — — — — *End Advance material* — — — — —

Equations (8.61) or (8.62) or (8.63) requires that the stress tensor be defined in term of the velocity/deformation. The relationship between the stress tensor and deformation depends on the classes of materials the stresses acts on. Additionally, the deformation can be viewed as a function of the velocity field. As engineers do in general, the simplest model is assumed which referred as the solid continuum model. In this model the relationship between the (shear) stresses and rate of strains are assumed to be

linear. In solid material, the shear stress yields a fix amount of deformation. In contrast, when applying the shear stress in fluids, the result is a continuous deformation. Furthermore, reduction of the shear stress does not return the material to its original state as in solids. The similarity to solids the increase shear stress in fluids yields larger deformations. Thus this “solid” model is a linear relationship with three main assumptions:

- a. There is no preference in the orientation (also call isentropic fluid),
- b. there is no left over stresses (In other words when the “no shear stress” situation exist the rate of deformation or strain is zero), and
- c. a linear relationship exist between the shear stress and the rate of shear strain.

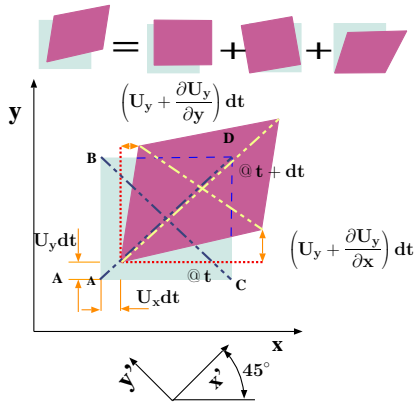

Fig. -8.9. Control volume at  $t$  and  $t + dt$  under continuous angle deformation. Notice the three combinations of the deformation shown by purple color relative to blue color.

At time  $t$ , the control volume is at a square shape and at a location as depicted in Figure 8.9 (by the blue color). At time  $t + dt$  the control volume undergoes three different changes. The control volume moves to a new location, rotates and changes the shape (the purple color in in Figure 8.9). The translational movement is referred to a movement of body without change of the body and without rotation. The rotation is the second movement that referred to a change in of the relative orientation inside the control volume. The third change is the misconfiguration or control volume (deformation). The deformation of the control volume has several components (see the top of Figure 8.9). The shear stress is related to the change in angle of the control volume lower left corner. The angle between  $x$  to the new location of the control volume can be approximate for a small angle as

$$\frac{d\gamma_x}{dt} = \tan \left( \frac{U_y + \frac{dU_y}{dx} dx - U_y}{dx} \right) = \tan \left( \frac{dU_y}{dx} \right) \cong \frac{dU_y}{dx} \quad (8.67)$$

The total angle deformation (two sides  $x$  and  $y$ ) is

$$\frac{D\gamma_{xy}}{Dt} = \frac{dU_y}{dx} + \frac{dU_x}{dy} \quad (8.68)$$

In these derivatives, the symmetry  $\frac{dU_y}{dx} \neq \frac{dU_x}{dy}$  was not assumed and or required because rotation of the control volume. However, under isentropic material it is assumed that

all the shear stresses contribute equally. For the assumption of a linear fluid<sup>15</sup>.

$$\tau_{xy} = \mu \frac{D\gamma_{xy}}{Dt} = \mu \left( \frac{dU_y}{dx} + \frac{dU_x}{dy} \right) \quad (8.69)$$

where,  $\mu$  is the “normal” or “ordinary” viscosity coefficient which relates the linear coefficient of proportionality and shear stress. This deformation angle coefficient is assumed to be a property of the fluid. In a similar fashion it can be written to other directions for  $xz$  as

$$\tau_{xz} = \mu \frac{D\gamma_{xz}}{Dt} = \mu \left( \frac{dU_z}{dx} + \frac{dU_x}{dz} \right) \quad (8.70)$$

and for the directions of  $yz$  as

$$\tau_{yz} = \mu \frac{D\gamma_{yz}}{Dt} = \mu \left( \frac{dU_z}{dy} + \frac{dU_y}{dz} \right) \quad (8.71)$$

Note that the viscosity coefficient (the linear coefficient<sup>16</sup>) is assumed to be the same regardless of the direction. This assumption is referred as isotropic viscosity. It can be noticed at this stage, the relationship for the two of stress tensor parts was established. The only missing thing, at this stage, is the diagonal component which to be dealt below.

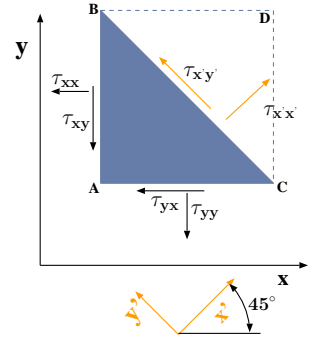

Fig. -8.10. Shear stress at two coordinates in  $45^\circ$  orientations.

— — — — — Advance material can be skipped — — — — —

In general equation (8.69) can be written as

$$\tau_{ij} = \mu \frac{D\gamma_{ij}}{Dt} = \mu \left( \frac{dU_j}{di} + \frac{dU_i}{dj} \right) \quad (8.72)$$

where  $i \neq j$  and  $i = x$  or  $y$  or  $z$ .

— — — — — End Advance material — — — — —

### Normal Stress

The normal stress,  $\tau_{ii}$  (where  $i$  is either  $x, y, z$ ) appears in the shear matrix diagonal. To find the main (or the diagonal) stress the coordinates are rotate by  $45^\circ$ . The diagonal lines (line  $BC$  and line  $AD$  in Figure 8.9) in the control volume move to the new locations. In addition, the sides  $AB$  and  $AC$  rotate in unequal amount which make one diagonal line longer and one diagonal line shorter. The normal shear stress relates to the change in the diagonal line length change. This relationship can be obtained by changing the coordinates orientation as depicted by Figure 8.10. The  $dx$  is

<sup>15</sup>While not marked as important equation this equation is the source of the derivation.

<sup>16</sup>The first assumption was mentioned above.

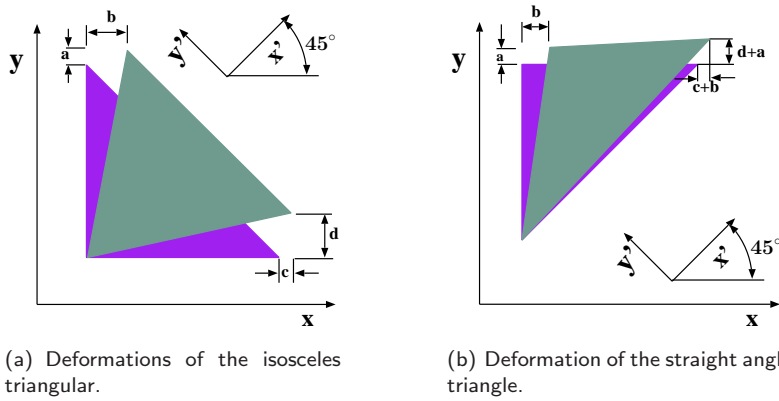

Fig. -8.11. Different triangles deformation for the calculations of the normal stress.

constructed so it equals to  $dy$ . The forces acting in the direction of  $x$  on the element are combination of several terms. For example, on the “ $x$ ” surface (lower surface) and the “ $y$ ” (left) surface, the shear stresses are acting in this direction. It can be noticed that “ $dx$ ” surface is  $\sqrt{2}$  times larger than  $dx$  and  $dy$  surfaces. The force balance in the  $x$  is

$$\underbrace{dy}_{A_x} \tau_{xx} \frac{\cos \theta_x}{\sqrt{2}} + \underbrace{dx}_{A_y} \tau_{yy} \frac{\cos \theta_y}{\sqrt{2}} + \underbrace{dx}_{A_y} \tau_{yx} \frac{\cos \theta_y}{\sqrt{2}} + \underbrace{dy}_{A_x} \tau_{xy} \frac{\cos \theta_x}{\sqrt{2}} = \underbrace{dx\sqrt{2}}_{A_{x'}} \tau_{x'x'} \quad (8.73)$$

dividing by  $dx$  and after some rearrangements utilizing the identity  $\tau_{xy} = \tau_{yx}$  results in

$$\frac{\tau_{xx} + \tau_{yy}}{2} + \tau_{yx} = \tau_{x'x'} \quad (8.74)$$

Setting the similar analysis in the  $y$  results in

$$\frac{\tau_{xx} + \tau_{yy}}{2} - \tau_{yx} = \tau_{y'y'} \quad (8.75)$$

Subtracting (8.75) from (8.74) results in

$$2\tau_{yx} = \tau_{x'x'} - \tau_{y'y'} \quad (8.76)$$

or dividing by 2 equation (8.76) becomes

$$\tau_{yx} = \frac{1}{2} (\tau_{x'x'} - \tau_{y'y'}) \quad (8.77)$$

Equation (8.76) relates the difference between the normal shear stress and the normal shear stresses in  $x, y$  coordinates) and the angular strain rate in the regular  $(x, y$

coordinates). The linear deformations in the  $x$  and  $y$  directions which is rotated  $45^\circ$  relative to the  $x$  and  $y$  axes can be expressed in both coordinates system. The angular strain rate in the  $(x, y)$  is frame related to the strain rates in the  $(x', y')$  frame. Figure 8.11(a) depicts the deformations of the triangular particles between time  $t$  and  $t + dt$ . The small deformations  $a$ ,  $b$ ,  $c$ , and  $d$  in the Figure are related to the incremental linear strains. The rate of strain in the  $x$  direction is

$$d\epsilon_x = \frac{c}{dx} \quad (8.78)$$

The rate of the strain in  $y$  direction is

$$d\epsilon_y = \frac{a}{dx} \quad (8.79)$$

The total change in the deformation angle is related to  $\tan \theta$ , in both sides  $(d/dx + b/dy)$  which in turn is related to combination of the two sides angles. The linear angular deformation in  $xy$  direction is

$$d\gamma_{xy} = \frac{b + d}{dx} \quad (8.80)$$

Here,  $d\epsilon_x$  is the linear strain (increase in length divided by length) of the particle in the  $x$  direction, and  $d\epsilon_y$  is its linear strain in the  $y$ -direction. The linear strain in the  $x'$  direction can be computed by observing Figure 8.11(b). The hypotenuse of the triangle is oriented in the  $x$  direction (again observe Figure 8.11(b)). The original length of the hypotenuse  $\sqrt{2}dx$ . The change in the hypotenuse length is  $\sqrt{(c + b)^2 + (a + d)^2}$ . It can be approximated that the change is about  $45^\circ$  because changes are infinitesimally small. Thus,  $\cos 45^\circ$  or  $\sin 45^\circ$  times the change contribute as first approximation to change. Hence, the ratio strain in the  $x$  direction is

$$d\epsilon_x = \frac{\sqrt{(c + b)^2 + (a + d)^2}}{\sqrt{2}dx} \simeq \frac{\frac{(c + b)}{\sqrt{2}} + \frac{(c + b)}{\sqrt{2}} + \overbrace{f(dx)}^{\sim 0}}{\sqrt{2}dx} \quad (8.81)$$

Equation (8.81) can be interpreted as (using equations (8.78), (8.79), and (8.80)) as

$$d\epsilon_x = \frac{1}{2} \left( \frac{a + b + c + d}{dx} \right) = \frac{1}{2} (d\epsilon_y + d\epsilon_y + d\gamma_{xy}) \quad (8.82)$$

In the same fashion, the strain in  $y$  coordinate can be interpreted to be

$$d\epsilon_y = \frac{1}{2} (d\epsilon_y + d\epsilon_y - d\gamma_{xy}) \quad (8.83)$$

Notice the negative sign before  $d\gamma_{xy}$ . Combining equation (8.82) with equation (8.83) results in

$$d\epsilon_x - d\epsilon_y = d\gamma_{xy} \quad (8.84)$$



Equation (8.84) describing in Lagrangian coordinates a single particle. Changing it to the Eulerian coordinates transforms equation (8.84) into

$$\frac{D\epsilon_{x'}}{Dt} - \frac{D\epsilon_{y'}}{Dt} = \frac{D\gamma_{xy}}{Dt} \tag{8.85}$$

From (8.69) it can be observed that the right hand side of equation (8.85) can be replaced by  $\tau_{xy}/\mu$  to read

$$\frac{D\epsilon_{x'}}{Dt} - \frac{D\epsilon_{y'}}{Dt} = \frac{\tau_{xy}}{\mu} \tag{8.86}$$

From equation (8.76)  $\tau_{xy}$  be substituted and equation (8.86) can be continued and replaced as

$$\frac{D\epsilon_{x'}}{Dt} - \frac{D\epsilon_{y'}}{Dt} = \frac{1}{2\mu} (\tau_{x'x'} - \tau_{y'y'}) \tag{8.87}$$

Figure 8.12 depicts the approximate linear deformation of the element. The linear deformation is the difference between the two sides as

$$\frac{D\epsilon_{x'}}{Dt} = \frac{\partial U_{x'}}{\partial x'} \tag{8.88}$$

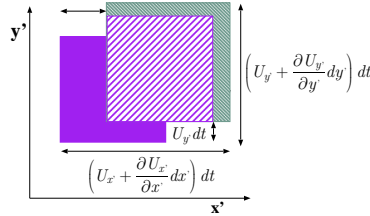

The same way it can written for the  $y'$  coordinate.

$$\frac{D\epsilon_{y'}}{Dt} = \frac{\partial U_{y'}}{\partial y'} \tag{8.89}$$

Fig. -8.12. Linear strain of the element purple denotes  $t$  and blue is for  $t + dt$ . Dashed squares denotes the movement without the linear change.

Equation (8.88) can be written in the  $y'$  and is similar by substituting the coordinates. The rate of strain relations can be substituted by the velocity and equations (8.88) and (8.89) changes into

$$\tau_{x'x'} - \tau_{y'y'} = 2\mu \left( \frac{\partial U_{x'}}{\partial x'} - \frac{\partial U_{y'}}{\partial y'} \right) \tag{8.90}$$

Similar two equations can be obtained in the other two plans. For example in  $y'-z'$  plan one can obtained

$$\tau_{x'x'} - \tau_{z'z'} = 2\mu \left( \frac{\partial U_{x'}}{\partial x'} - \frac{\partial U_{z'}}{\partial z'} \right) \tag{8.91}$$

Adding equations (8.90) and (8.91) results in

$$\overbrace{(3-1)}^2 \tau_{x'x'} - \tau_{y'y'} - \tau_{z'z'} = \overbrace{(6-2)}^4 \mu \frac{\partial U_{x'}}{\partial x'} - 2\mu \left( \frac{\partial U_{y'}}{\partial y'} + \frac{\partial U_{z'}}{\partial z'} \right) \tag{8.92}$$

rearranging equation (8.92) transforms it into

$$3\tau_{x'x'} = \tau_{x'x'} + \tau_{y'y'} + \tau_{z'z'} + 6\mu \frac{\partial U_{x'}}{\partial x'} - 2\mu \left( \frac{\partial U_{x'}}{\partial x'} + \frac{\partial U_{y'}}{\partial y'} + \frac{\partial U_{z'}}{\partial z'} \right) \quad (8.93)$$

Dividing the results by 3 so that one can obtained the following

$$\tau_{x'x'} = \overbrace{\frac{\tau_{x'x'} + \tau_{y'y'} + \tau_{z'z'}}{3}}^{\text{"mechanical" pressure}} + 2\mu \frac{\partial U_{x'}}{\partial x'} - \frac{2}{3}\mu \left( \frac{\partial U_{x'}}{\partial x'} + \frac{\partial U_{y'}}{\partial y'} + \frac{\partial U_{z'}}{\partial z'} \right) \quad (8.94)$$

The "mechanical" pressure,  $P_m$ , is defined as the (negative) average value of pressure in directions of  $x$ - $y$ - $z$ . This pressure is a true scalar value of the flow field since the propriety is averaged or almost<sup>17</sup> invariant to the coordinate transformation. In situations where the main diagonal terms of the stress tensor are not the same in all directions (in some viscous flows) this property can be served as a measure of the local normal stress. The mechanical pressure can be defined as averaging of the normal stress acting on a infinitesimal sphere. It can be shown that this two definitions are "identical" in the limits<sup>18</sup>. With this definition and noticing that the coordinate system  $x$ - $y$  has no special significance and hence equation (8.94) must be valid in any coordinate system thus equation (8.94) can be written as

$$\tau_{xx} = -P_m + 2\mu \frac{\partial U_x}{\partial x} + \frac{2}{3}\mu \nabla \cdot \mathbf{U} \quad (8.95)$$

Again where  $P_m$  is the mechanical pressure and is defined as

**Mechanical Pressure**

$$P_m = -\frac{\tau_{xx} + \tau_{yy} + \tau_{zz}}{3} \quad (8.96)$$

It can be observed that the non main (diagonal) terms of the stress tensor are represented by an equation like (8.72). Commonality engineers like to combined the two difference expressions into one as

$$\tau_{xy} = -\left( P_m + \frac{2}{3}\mu \nabla \cdot \mathbf{U} \right) \overbrace{\delta_{xy}}^{=0} + \mu \left( \frac{\partial U_x}{\partial y} + \frac{\partial U_y}{\partial x} \right) \quad (8.97)$$

or

$$\tau_{xx} = -\left( P_m + \frac{2}{3}\mu \nabla \cdot \mathbf{U} \right) \overbrace{\delta_{xy}}^{=1} + \mu \left( \frac{\partial U_x}{\partial x} + \frac{\partial U_y}{\partial y} \right) \quad (8.98)$$

— — — — — *Advance material can be skipped* — — — — —

<sup>17</sup>It identical only in the limits to the mechanical measurements.

<sup>18</sup>G. K. Batchelor, An Introduction to Fluid Mechanics, Cambridge University Press, 1967, p.141.

or index notation

$$\tau_{ij} = - \left( P_m + \frac{2}{3} \mu \nabla \cdot \mathbf{U} \right) \delta_{ij} + \mu \left( \frac{\partial U_i}{\partial x_j} + \frac{\partial U_j}{\partial x_i} \right) \quad (8.99)$$

— — — — — *End Advance material* — — — — —

where  $\delta_{ij}$  is the Kronecker delta what is  $\delta_{ij} = 1$  when  $i = j$  and  $\delta_{ij} = 0$  otherwise. While this expression has the advantage of compact writing, it does not add any additional information. This expression suggests a new definition of the thermodynamical pressure is

Thermodynamic Pressure

$$P = P_m + \frac{2}{3} \mu \nabla \cdot \mathbf{U} \quad (8.100)$$

### Summary of The Stress Tensor

The above derivations were provided as a long mathematical explanation<sup>19</sup>. To reduced one unknown (the shear stress) equation (8.61) the relationship between the stress tensor and the velocity were to be established. First, connection between  $\tau_{xy}$  and the deformation was built. Then the association between normal stress and perpendicular stress was constructed. Using the coordinates transformation, this association was established. The linkage between the stress in the rotated coordinates to the deformation was established.

### Second Viscosity Coefficient

The coefficient  $2/3\mu$  is experimental and relates to viscosity. However, if the derivations before were to include additional terms, an additional correction will be needed. This correction results in

$$P = P_m + \lambda \nabla \cdot \mathbf{U} \quad (8.101)$$

The value of  $\lambda$  is obtained experimentally. This coefficient is referred in the literature by several terms such as the “expansion viscosity” “second coefficient of viscosity” and “bulk viscosity.” Here the term bulk viscosity will be adapted. The dimension of the bulk viscosity,  $\lambda$ , is similar to the viscosity  $\mu$ . According to second law of thermodynamic derivations (not shown here and are under construction) demonstrate that  $\lambda$  must be positive. The thermodynamic pressure always tends to follow the mechanical pressure during a change. The expansion rate of change and the fluid molecular structure through  $\lambda$  control the difference. Equation (8.101) can be written in terms of the thermodynamic pressure  $P$ , as

$$\tau_{ij} = - \left[ P + \left( \frac{2}{3} \mu - \lambda \right) \nabla \cdot \mathbf{U} \right] \delta_{ij} + \mu \left( \frac{\partial U_i}{\partial x_j} + \frac{\partial U_j}{\partial x_i} \right) \quad (8.102)$$

<sup>19</sup>Since the publishing the version 0.2.9.0 several people ask this author to summarize conceptually the issues. With God help, it will be provide before version 0.3.1

The significance of the difference between the thermodynamic pressure and the mechanical pressure associated with fluid dilation which connected by  $\nabla \cdot \mathbf{U}$ . The physical meaning of  $\nabla \cdot \mathbf{U}$  represents the relative volume rate of change. For simple gas (dilute monatomic gases) it can be shown that  $\lambda$  vanishes. In material such as water,  $\lambda$  is large (3 times  $\mu$ ) but the net effect is small because in that cases  $\nabla \cdot \mathbf{U} \rightarrow 0$ . For complex liquids this coefficient,  $\lambda$ , can be over 100 times larger than  $\mu$ . Clearly for incompressible flow, this coefficient or the whole effect is vanished<sup>20</sup>. In most cases, the total effect of the dilation on the flow is very small. Only in micro fluids and small and molecular scale such as in shock waves this effect has some significance. In fact this effect is so insignificant that there is difficulty in to construct experiments so this effect can be measured. Thus, neglecting this effect results in

$$\tau_{ij} = -P\delta_{ij} + \mu \left( \frac{\partial U_i}{\partial x_j} + \frac{\partial U_j}{\partial x_i} \right) \quad (8.103)$$

To explain equation (8.103), it can be written for specific coordinates. For example, for the  $\tau_{xx}$  it can be written that

$$\tau_{xx} = -P + 2 \frac{\partial U_x}{\partial x} \quad (8.104)$$

and the  $y$  coordinate the equation is

$$\tau_{yy} = -P + 2 \frac{\partial U_y}{\partial y} \quad (8.105)$$

however the mix stress,  $\tau_{xy}$ , is

$$\tau_{xy} = \tau_{yx} = \left( \frac{\partial U_y}{\partial x} + \frac{\partial U_x}{\partial y} \right) \quad (8.106)$$

For the total effect, substitute equation (8.102) into equation (8.61) which results in

$$\rho \left( \frac{DU_x}{Dt} \right) = - \frac{\partial (P + (\frac{2}{3}\mu - \lambda) \nabla \cdot \mathbf{U})}{\partial x} + \mu \left( \frac{\partial^2 U_x}{\partial x^2} + \frac{\partial^2 U_x}{\partial y^2} + \frac{\partial^2 U_x}{\partial z^2} \right) + \mathbf{f}_{B_x} \quad (8.107)$$

or in a vector form as

N-S in stationary Coordinates

$$\rho \frac{D\mathbf{U}}{Dt} = -\nabla P + \left( \frac{1}{3}\mu + \lambda \right) \nabla (\nabla \cdot \mathbf{U}) + \mu \nabla^2 \mathbf{U} + \mathbf{f}_B \quad (8.108)$$

<sup>20</sup>The reason that the effect vanish is because  $\nabla \cdot \mathbf{U} = 0$ .

For in index form as

$$\rho \frac{DU_i}{Dt} = -\frac{\partial}{\partial x_i} \left( P + \left( \frac{2}{3}\mu - \lambda \right) \nabla \cdot \mathbf{U} \right) + \frac{\partial}{\partial x_j} \left( \mu \left( \frac{\partial U_i}{\partial x_j} + \frac{\partial U_j}{\partial x_i} \right) \right) + \mathbf{f}_{Bi} \quad (8.109)$$

For incompressible flow the term  $\nabla \cdot \mathbf{U}$  vanishes, thus equation (8.108) is reduced to

Momentum for Incompressible Flow

$$\rho \frac{D\mathbf{U}}{Dt} = -\nabla P + \mu \nabla^2 \mathbf{U} + \mathbf{f}_B \quad (8.110)$$

or in the index notation it is written

$$\rho \frac{DU_i}{Dt} = -\frac{\partial P}{\partial x_i} + \mu \frac{\partial^2 U_i}{\partial x_j \partial x_j} + \mathbf{f}_{Bi} \quad (8.111)$$

The momentum equation in Cartesian coordinate can be written explicitly for  $x$  coordinate as

$$\rho \left( \frac{\partial U_x}{\partial t} + U_x \frac{\partial U_x}{\partial x} + U_y \frac{\partial U_x}{\partial y} + U_z \frac{\partial U_x}{\partial z} \right) = -\frac{\partial P}{\partial x} + \mu \left( \frac{\partial^2 U_x}{\partial x^2} + \frac{\partial^2 U_x}{\partial y^2} + \frac{\partial^2 U_x}{\partial z^2} \right) + \rho g_x \quad (8.112)$$

Where  $g_x$  is the the body force in the  $x$  direction ( $\hat{i} \cdot \mathbf{g}$ ). In the  $y$  coordinate the momentum equation is

$$\rho \left( \frac{\partial U_y}{\partial t} + U_x \frac{\partial U_y}{\partial x} + U_y \frac{\partial U_y}{\partial y} + U_z \frac{\partial U_y}{\partial z} \right) = -\frac{\partial P}{\partial y} + \mu \left( \frac{\partial^2 U_y}{\partial x^2} + \frac{\partial^2 U_y}{\partial y^2} + \frac{\partial^2 U_y}{\partial z^2} \right) + \rho g_y \quad (8.113)$$

in  $z$  coordinate the momentum equation is

$$\rho \left( \frac{\partial U_z}{\partial t} + U_x \frac{\partial U_z}{\partial x} + U_y \frac{\partial U_z}{\partial y} + U_z \frac{\partial U_z}{\partial z} \right) = -\frac{\partial P}{\partial z} + \mu \left( \frac{\partial^2 U_z}{\partial x^2} + \frac{\partial^2 U_z}{\partial y^2} + \frac{\partial^2 U_z}{\partial z^2} \right) + \rho g_z \quad (8.114)$$

## 8.6 Boundary Conditions and Driving Forces

### 8.6.1 Boundary Conditions Categories

The governing equations that were developed earlier requires some boundary conditions and initial conditions. These conditions described physical situations that are believed or should exist or approximated. These conditions can be categorized by the velocity,

pressure, or in more general terms as the shear stress conditions (mostly at the interface). For this discussion, the shear tensor will be separated into two categories, pressure (at the interface direction) and shear stress (perpendicular to the area). A common velocity condition is that the liquid has the same value as the solid interface velocity. In the literature, this condition is referred as the “no slip” condition. The solid surface is rough thus the liquid particles (or molecules) are slowed to be at the solid surface velocity. This boundary condition was experimentally observed under many conditions yet it is not universal true. The slip condition (as oppose to “no slip” condition) exist in situations where the scale is very small and the velocity is relatively very small. The slip condition is dealing with a difference in the velocity between the solid (or other material) and the fluid media. The difference between the small scale and the large scale is that the slip can be neglected in the large scale while the slip cannot be neglected in the small scale. In another view, the difference in the velocities vanishes as the scale increases. Another condition which affects whether the slip condition exist is how rapidly of the velocity change. The slip condition cannot be ignored in some regions, when the flow is with a strong velocity fluctuations. Mathematically the “no slip” condition is written as

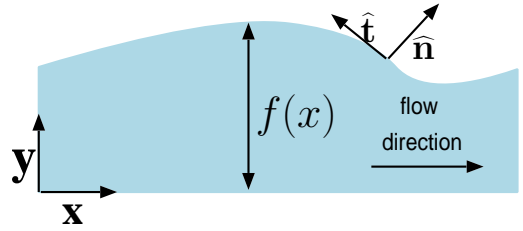

$$\hat{\mathbf{t}} \cdot (\mathbf{U}_{fluid} - \mathbf{U}_{boundary}) = 0 \quad \text{Fig. -8.13. 1-Dimensional free surface describing } \hat{\mathbf{n}} \text{ and } \hat{\mathbf{t}}. \quad (8.115)$$

where  $\hat{\mathbf{n}}$  is referred to the area direction (perpendicular to the area see Figure 8.13). While this condition (8.115) is given in a vector form, it is more common to write this condition as a given velocity at a certain point such as

$$U(\ell) = U_\ell \quad (8.116)$$

Note, the “no slip” condition is applicable to the ideal fluid (“inviscid flows”) because this kind of flow normally deals with large scales. The “slip” condition is written in similar fashion to equation (8.115) as

$$\hat{\mathbf{t}} \cdot (\mathbf{U}_{fluid} - \mathbf{U}_{boundary}) = f(Q, scale, etc) \quad (8.117)$$

As oppose to a given velocity at particular point, a requirement on the acceleration (velocity) can be given in unknown position. The condition (8.115) can be mathematically represented in another way for free surface conditions. To make sure that all the material is accounted for in the control volume (does not cross the free surface), the relative perpendicular velocity at the interface must be zero. The location of the (free) moving boundary can be given as  $f(\hat{\mathbf{r}}, t) = 0$  as the equation which describes the bounding surface. The perpendicular relative velocity at the surface must be zero

and therefore

$$\frac{Df}{Dt} = 0 \quad \text{on the surface } f(\hat{\mathbf{r}}, t) = 0 \quad (8.118)$$

This condition is called the kinematic boundary condition. For example, the free surface in the two dimensional case is represented as  $f(t, x, y)$ . The condition becomes as

$$0 = \frac{\partial f}{\partial t} + U_x \frac{\partial f}{\partial x} + U_y \frac{\partial f}{\partial y} \quad (8.119)$$

The solution of this condition, sometime, is extremely hard to handle because the location isn't given but the derivative given on unknown location. In this book, this condition will not be discussed (at least not plane to be written).

The free surface is a special case of moving surfaces where the surface between two distinct fluids. In reality the interface between these two fluids is not a sharp transition but only approximation (see for the surface theory). There are situations where the transition should be analyzed as a continuous transition between two phases. In other cases, the transition is idealized an almost jump (a few molecules thickness). Furthermore, there are situations where the fluid (above one of the sides) should be considered as weightless material. In these cases the assumptions are that the transition occurs in a sharp line, and the density has a jump while the shear stress are continuous (in some cases continuously approach zero value). While a jump in density does not break any physical laws (at least those present in the solution), the jump in a shear stress (without a jump in density) does break a physical law. A jump in the shear stress creates infinite force on the adjoin thin layer. Off course, this condition cannot be tolerated since infinite velocity (acceleration) is impossible. The jump in shear stress can appear when the density has a jump in density. The jump in the density (between the two fluids) creates a surface tension which offset the jump in the shear stress. This condition is expressed mathematically by equating the shear stress difference to the forces results due to the surface tension. The shear stress difference is

$$\Delta \boldsymbol{\tau}^{(n)} = 0 = \Delta \boldsymbol{\tau}_{\text{surface}}^{\text{upper}(n)} - \Delta \boldsymbol{\tau}_{\text{surface}}^{\text{lower}(n)} \quad (8.120)$$

where the index  $(n)$  indicate that shear stress are normal (in the surface area). If the surface is straight there is no jump in the shear stress. The condition with curved surface are out the scope of this book yet mathematically the condition is given as without explanation as

$$\hat{\mathbf{n}} \cdot \boldsymbol{\tau}^{(n)} = \sigma \left( \frac{1}{R_1} + \frac{1}{R_2} \right) \quad (8.121)$$

$$\hat{\mathbf{t}} \cdot \boldsymbol{\tau}^{(t)} = -\hat{\mathbf{t}} \cdot \nabla \sigma \quad (8.122)$$

where  $\hat{\mathbf{n}}$  is the unit normal and  $\hat{\mathbf{t}}$  is a unit tangent to the surface (notice that direction pointed out of the "center" see Figure 8.13) and  $R_1$  and  $R_2$  are principal radii. One of results of the free surface condition (or in general, the moving surface condition) is

that integration constant is unknown). In some instances, this constant is determined from the volume conservation. In index notation equation (8.121) is written<sup>21</sup> as

$$\tau_{ij}^{(1)} n_j + \sigma n_i \left( \frac{1}{R_1} + \frac{1}{R_2} \right) = \tau_{ij}^{(2)} n_j \quad (8.123)$$

where 1 is the upper surface and 2 is the lower surface. For example in one dimensional<sup>22</sup>

$$\begin{aligned} \hat{\mathbf{n}} &= \frac{(-f'(x), 1)}{\sqrt{1 + (f'(x))^2}} \\ \hat{\mathbf{t}} &= \frac{(1, f'(x))}{\sqrt{1 + (f'(x))^2}} \end{aligned} \quad (8.124)$$

the unit vector is given as two vectors in  $x$  and  $y$  and the radius is given by equation (1.57). The equation is given by

$$\frac{\partial f}{\partial t} + U_x \frac{\partial f}{\partial x} = U_y \quad (8.125)$$

### The Pressure Condition

The second condition that commonality prescribed at the interface is the static pressure at a specific location. The static pressure is measured perpendicular to the flow direction. The last condition is similar to the pressure condition of prescribed shear stress or a relationship to it. In this category include the boundary conditions with issues of surface tension which were discussed earlier. It can be noticed that the boundary conditions that involve the surface tension are of the kind where the condition is given on boundary but no at a specific location.

### Gravity as Driving Force

The body forces, in general and gravity in a particular, are the condition that given on the flow beside the velocity, shear stress (including the surface tension) and the pressure. The gravity is a common body force which is considered in many fluid mechanics problems. The gravity can be considered as a constant force in most cases (see for dimensional analysis for the reasons).

### Shear Stress and Surface Tension as Driving Force

<sup>21</sup>There is no additional benefit in this writing, it just for completeness and can be ignored for most purposes.

<sup>22</sup>A one example of a reference not in particularly important or significant just a random example. Jean, M. Free surface of the steady flow of a Newtonian fluid in a finite channel. Arch. Rational Mech. Anal. 74 (1980), no. 3, 197–217.



If the fluid was solid material, pulling the side will pull all the material. In fluid (mostly liquid) shear stress pulling side (surface) will have limited effect and yet sometime is significant and more rarely dominate. Consider, for example, the case shown in Figure 8.14. The shear stress carry the material as if part of the material was a solid material. For example, in the kerosene lamp the burning occurs at the surface of the lamp top and the liquid is at the bottom. The liquid does not move up due the gravity (actually it is against the gravity) but because the surface tension.



Fig. -8.14. Kerosene lamp.

The physical conditions in Figure 8.14 are used to idealize the flow around an inner rode to understand how to apply the surface tension to the boundary conditions. The fluid surrounds the rode and flows upwards. In that case, the velocity at the surface of the inner rode is zero. The velocity at the outer surface is unknown. The boundary condition at outer surface given by a jump of the shear stress. The outer diameter is depends on the surface tension (the larger surface tension the smaller the liquid diameter). The surface tension is a function of the temperature therefore the gradient in surface tension is result of temperature gradient.

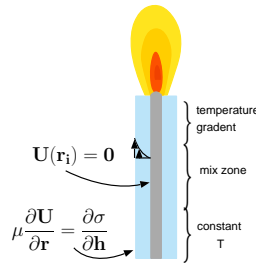

Fig. -8.15. Flow in a kandle with a surface tension gradient.

In this book, this effect is not discussed. However, somewhere downstream the temperature gradient is insignificant. Even in that case, the surface tension gradient remains. It can be noticed that, under the assumption presented here, there are two principal radii of the flow. One radius toward the center of the rode while the other radius is infinite (approximatly). In that case, the contribution due to the curvature is zero in the direction of the flow (see Figure 8.15). The only (almost) propelling source of the flow is the surface gradient ( $\frac{\partial \sigma}{\partial n}$ ).

## 8.7 Examples for Differential Equation (Navier-Stokes)

Examples of an one-dimensional flow driven by the shear stress and pressure are presented. For further enhance the understanding some of the derivations are repeated. First, example dealing with one phase are present. Later, examples with two phase are presented.

### Example 8.6:

*Incompressible liquid flows between two infinite plates from the left to the right (as shown in Figure 8.16). The distance between the plates is  $\ell$ . The static pressure per*

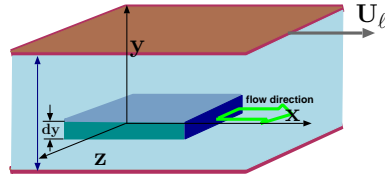

Fig. -8.16. Flow between two plates, top plate is moving at speed of  $U_\ell$  to the right (as positive). The control volume shown in darker colors.

length is given as  $\Delta P^{23}$ . The upper surface is moving in velocity,  $U_\ell$  (The right side is defined as positive).

### SOLUTION

In this example, the mass conservation yields

$$\overbrace{\frac{d}{dt} \int_{cv} \rho dV}^{=0} = - \int_{cv} \rho U_{rn} dA = 0 \quad (8.126)$$

The momentum is not accumulated (steady state and constant density). Further because no change of the momentum thus

$$\int_A \rho U_x U_{rn} dA = 0 \quad (8.127)$$

Thus, the flow in and the flow out are equal. It can concluded that the velocity in and out are the same (for constant density). The momentum conservation leads

$$- \int_{cv} P dA + \int_{cv} \tau_{xy} dA = 0 \quad (8.128)$$

The reaction of the shear stress on the lower surface of control volume based on Newtonian fluid is

$$\tau_{xy} = -\mu \frac{dU}{dy} \quad (8.129)$$

On the upper surface is different by Taylor explanation as

$$\tau_{xy} = \mu \left( \frac{dU}{dy} + \frac{d^2U}{dy^2} dy + \overbrace{\frac{d^3U}{dy^3} dy^2}^{\cong 0} + \dots \right) \quad (8.130)$$

<sup>23</sup>The difference is measured at the bottom point of the plate.

The net effect of these two will be difference between them

$$\mu \left( \frac{dU}{dy} + \frac{d^2U}{dy^2} dy \right) - \mu \frac{dU}{dy} \cong \mu \frac{d^2U}{dy^2} dy \tag{8.131}$$

The assumption is that there is no pressure difference in the  $z$  direction. The only difference in the pressure is in the  $x$  direction and thus

$$P - \left( P + \frac{dP}{dx} dx \right) = - \frac{dP}{dx} dx \tag{8.132}$$

A discussion why  $\frac{\partial P}{\partial y} \sim 0$  will be presented later. The momentum equation in the  $x$  direction (or from equation (8.112)) results (without gravity effects) in

$$- \frac{dP}{dx} = \mu \frac{d^2U}{dy^2} \tag{8.133}$$

Equation (8.133) was constructed under several assumptions which include the direction of the flow, Newtonian fluid. No assumption was imposed on the pressure distribution. Equation (8.133) is a partial differential equation but can be treated as ordinary differential equation in the  $z$  direction of the pressure difference is uniform. In that case, the left hand side is equal to constant. The “standard” boundary conditions is non-vanishing pressure gradient (that is the pressure exist) and velocity of the upper or lower surface or both. It is common to assume that the “no slip” condition on the boundaries condition<sup>24</sup>. The boundaries conditions are

$$\begin{aligned} U_x(y = 0) &= 0 \\ U_x(y = \ell) &= U_\ell \end{aligned} \tag{8.134}$$

The solution of the “ordinary” differential equation (8.133) after the integration becomes

$$U_x = - \frac{1}{2} \frac{dP}{dx} y^2 + c_2 y + c_3 \tag{8.135}$$

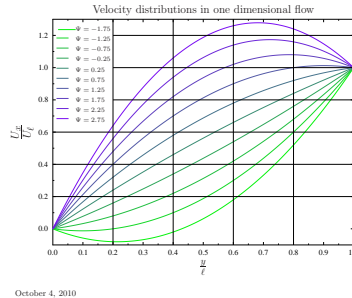

Fig. -8.17. One dimensional flow with a shear between two plates when  $\Psi$  change value between -1.75 green line to 3 the blue line.

<sup>24</sup>A discussion about the boundary will be presented later.

Applying the boundary conditions, equation (8.134) results in

$$U_x(y) = \frac{y}{\ell} \left( \overbrace{\frac{\ell^2}{U_0 2\mu} \frac{dP}{dx}}^{=\Psi} \left(1 - \frac{y}{\ell}\right) \right) + \frac{y}{\ell} \quad (8.136)$$

For the case where the pressure gradient is zero the velocity is linear as was discussed earlier in Chapter 1 (see Figure 8.17). However, if the plates or the boundary conditions do not move the solution is

$$U_x(y) = \left( \frac{\ell^2}{U_0 2\mu} \frac{dP}{dx} \left(1 - \frac{y}{\ell}\right) \right) + \frac{y}{\ell} \quad (8.137)$$

What happen when  $\frac{\partial P}{\partial y} \sim 0$ ?

End Solution

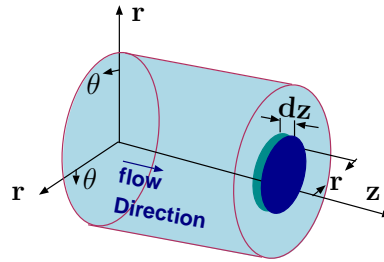

Fig. -8.18. The control volume of liquid element in cylindrical coordinates.

### Cylindrical Coordinates

Similarly the problem of one dimensional flow can be constructed for cylindrical coordinates. The problem is still one dimensional because the flow velocity is a function of (only) radius. This flow referred as Poiseuille flow after Jean Louis Poiseuille a French Physician who investigated blood flow in veins. Thus, Poiseuille studied the flow in a small diameters (he was not familiar with the concept of Reynolds numbers). Rederivation are carried out for a short cut.

The momentum equation for the control volume depicted in the Figure 8.18a is

$$-\int \mathbf{P} dA + \int \boldsymbol{\tau} dA = \int \rho U_z U_{rn} dA \quad (8.138)$$

The shear stress in the front and back surfaces do no act in the  $z$  direction. The shear stress on the circumferential part small dark blue shown in Figure 8.18a is

$$\int \boldsymbol{\tau} dA = \mu \frac{dU_z}{dr} \overbrace{2\pi r dz}^{dA} \quad (8.139)$$

The pressure integral is

$$\int \mathbf{P} dA = (P_{z+dz} - P_z) \pi r^2 = \left( P_z + \frac{\partial P}{\partial z} dz - P_z \right) \pi r^2 = \frac{\partial P}{\partial z} dz \pi r^2 \quad (8.140)$$

The last term is

$$\begin{aligned} \int \rho U_z U_{rn} dA &= \rho \int U_z U_{rn} dA = \\ \rho \left( \int_{z+dz} U_{z+dz}^2 dA - \int_z U_z^2 dA \right) &= \rho \int_z (U_{z+dz}^2 - U_z^2) dA \end{aligned} \quad (8.141)$$

The term  $U_{z+dz}^2 - U_z^2$  is zero because  $U_{z+dz} = U_z$  because mass conservation conservation for any element. Hence, the last term is

$$\int \rho U_z U_{rn} dA = 0 \quad (8.142)$$

Substituting equation (8.139) and (8.140) into equation (8.138) results in

$$\mu \frac{dU_z}{dr} 2\pi r dz = - \frac{\partial P}{\partial z} dz \pi r^2 \quad (8.143)$$

Which shrinks to

$$\frac{2\mu}{r} \frac{dU_z}{dr} = - \frac{\partial P}{\partial z} \quad (8.144)$$

Equation (8.144) is a first order differential equation for which only one boundary condition is needed. The “no slip” condition is assumed

$$U_z(r = R) = 0 \quad (8.145)$$

Where  $R$  is the outer radius of pipe or cylinder. Integrating equation (8.144) results in

$$U_z = - \frac{1}{\mu} \frac{\partial P}{\partial z} r^2 + c_1 \quad (8.146)$$

It can be noticed that asymmetrical element<sup>25</sup> was eliminated due to the smart short cut. The integration constant obtained via the application of the boundary condition which is

$$c_1 = - \frac{1}{\mu} \frac{\partial P}{\partial z} R^2 \quad (8.147)$$

The solution is

$$U_z = \frac{1}{\mu} \frac{\partial P}{\partial z} R^2 \left( 1 - \left( \frac{r}{R} \right)^2 \right) \quad (8.148)$$

While the above analysis provides a solution, it has several deficiencies which include the ability to incorporate different boundary conditions such as flow between centering cylinders.

<sup>25</sup>Asymmetrical element or function is  $-f(x) = f(-x)$

Example 8.7:

A liquid with a constant density is flowing between concentric cylinders as shown in Figure 8.19. Assume that the velocity at the surface of the cylinders is zero calculate the velocity profile. Build the velocity profile when the flow is one directional and viscosity is Newtonian. Calculate the flow rate for a given pressure gradient.

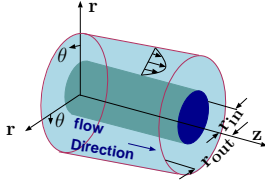

Fig. -8.19. Liquid flow between concentric cylinders for example 8.7.

SOLUTION

After the previous example, the appropriate version of the Navier–Stokes equation will be used. The situation is best suitable to solved in cylindrical coordinates. One of the solution of this problems is one dimensional solution. In fact there is no physical reason why the flow should be only one dimensional. However, it is possible to satisfy the boundary conditions. It turn out that the “simple” solution is the first mode that appear in reality. In this solution will be discussing the flow first mode. For this mode, the flow is assumed to be one dimensional. That is, the velocity isn’t a function of the angle, or z coordinate. Thus only equation in z coordinate is needed. It can be noticed that this case is steady state and also the acceleration (convective acceleration) is zero

$$\rho \left( \overbrace{\frac{\partial U_z}{\partial t}}^{\neq f(t)} + \overbrace{U_r \frac{\partial U_z}{\partial r}}^{=0} + \overbrace{\frac{U_\phi}{r} \frac{\partial U_z}{\partial \phi}}^{=0, U_z \neq f(\phi)} + \overbrace{U_z \frac{\partial U_z}{\partial z}}^{=0} \right) = 0 \tag{8.149}$$

The steady state governing equation then becomes

$$\rho (\emptyset) = 0 = -\frac{\partial P}{\partial z} + \mu \left( \frac{1}{r} \frac{\partial}{\partial r} \left( r \frac{\partial U_z}{\partial r} \right) + \overbrace{\dots}^{=0} \right) + \rho g_z \tag{8.VII.a}$$

The PDE above (8.VII.a) required boundary conditions which are

$$\begin{aligned} U_z (r = r_i) &= 0 \\ U_z (r = r_o) &= 0 \end{aligned} \tag{8.VII.b}$$

Integrating equation (8.VII.a) once results in

$$r \frac{\partial U_z}{\partial r} = \frac{1}{2\mu} \frac{\partial P}{\partial z} r^2 + c_1 \tag{8.VII.c}$$

Dividing equation (8.VII.c) and integrating results for the second times results

$$\frac{\partial U_z}{\partial r} = \frac{1}{2\mu} \frac{\partial P}{\partial z} r + \frac{c_1}{r} \tag{8.VII.d}$$

Integration of equation (8.VII.d) results in

$$U_z = \frac{1}{4\mu} \frac{\partial P}{\partial z} r^2 + c_1 \ln r + c_2 \tag{8.VII.e}$$

Applying the first boundary condition results in

$$0 = \frac{1}{4\mu} \frac{\partial P}{\partial z} r_i^2 + c_1 \ln r_i + c_2 \tag{8.VII.f}$$

applying the second boundary condition yields

$$0 = \frac{1}{4\mu} \frac{\partial P}{\partial z} r_o^2 + c_1 \ln r_o + c_2 \tag{8.VII.g}$$

The solution is

$$\begin{aligned} c_1 &= \frac{1}{4\mu} \ln \left( \frac{r_o}{r_i} \right) \frac{\partial P}{\partial z} (r_o^2 - r_i^2) \\ c_2 &= \frac{1}{4\mu} \ln \left( \frac{r_o}{r_i} \right) \frac{\partial P}{\partial z} (\ln(r_i) r_o^2 - \ln(r_o) r_i^2) \end{aligned} \tag{8.VII.h}$$

The solution is when substituting the constants into equation (8.VII.e) results in

$$\begin{aligned} U_z(r) &= \frac{1}{4\mu} \frac{\partial P}{\partial z} r^2 + \frac{1}{4\mu} \ln \left( \frac{r_o}{r_i} \right) \frac{\partial P}{\partial z} (r_o^2 - r_i^2) \ln r \\ &\quad + \frac{1}{4\mu} \ln \left( \frac{r_o}{r_i} \right) \frac{\partial P}{\partial z} (\ln(r_i) r_o^2 - \ln(r_o) r_i^2) \end{aligned} \tag{8.VII.i}$$

The flow rate is then

$$Q = \int_{r_i}^{r_o} U_z(r) dA \tag{8.VII.j}$$

Or substituting equation (8.VII.i) into equation (8.VII.j) transformed into

$$\begin{aligned} Q &= \int_A \left[ \frac{1}{4\mu} \frac{\partial P}{\partial z} r^2 + \frac{1}{4\mu} \ln \left( \frac{r_o}{r_i} \right) \frac{\partial P}{\partial z} (r_o^2 - r_i^2) \ln r \right. \\ &\quad \left. + \frac{1}{4\mu} \ln \left( \frac{r_o}{r_i} \right) \frac{\partial P}{\partial z} (\ln(r_i) r_o^2 - \ln(r_o) r_i^2) \right] dA \end{aligned} \tag{8.VII.k}$$

A finite integration of the last term in the integrand results in zero because it is constant. The integration of the rest is

$$Q = \left[ \frac{1}{4\mu} \frac{\partial P}{\partial z} \right] \int_{r_i}^{r_o} \left[ r^2 + \ln\left(\frac{r_o}{r_i}\right) (r_o^2 - r_i^2) \ln r \right] 2\pi r dr \quad (8.VII.l)$$

The first integration of the first part of the second square bracket,  $(r^3)$ , is  $1/4 (r_o^4 - r_i^4)$ . The second part, of the second square bracket,  $(-a \times r \ln r)$  can be done by parts to be as

$$a \left( \frac{r^2}{4} - \frac{r^2 \log(r)}{2} \right)$$

Applying all these “techniques” to equation (8.VII.l) results in

$$Q = \left[ \frac{\pi}{2\mu} \frac{\partial P}{\partial z} \right] \left[ \left( \frac{r_o^4}{4} - \frac{r_i^4}{4} \right) + \ln\left(\frac{r_o}{r_i}\right) (r_o^2 - r_i^2) \left( \frac{r_o^2 \ln(r_o)}{2} - \frac{r_o^2}{4} - \frac{r_i^2 \ln(r_i)}{2} + \frac{r_i^2}{4} \right) \right] \quad (8.VII.m)$$

The averaged velocity is obtained by dividing flow rate by the area  $Q/A$ .

$$U_{ave} = \frac{Q}{\pi(r_o^2 - r_i^2)} \quad (8.150)$$

in which the identity of  $(a^4 - b^4)/(a^2 - b^2)$  is  $b^2 + a^2$  and hence

$$U_{ave} = \left[ \frac{1}{2\mu} \frac{\partial P}{\partial z} \right] \left[ \left( \frac{r_o^2}{4} + \frac{r_i^2}{4} \right) + \ln\left(\frac{r_o}{r_i}\right) \left( \frac{r_o^2 \ln(r_o)}{2} - \frac{r_o^2}{4} - \frac{r_i^2 \ln(r_i)}{2} + \frac{r_i^2}{4} \right) \right] \quad (8.VII.n)$$

---

End Solution

---

### Example 8.8:

*For the conteraic velocity profile, at what radius the maximum velocity obtained. Draw the maximum velocity location as a function of the ratio  $r_i/r_o$ .*

The next example deals with the gravity as body force in two dimensional flow. This problem study by Nusselt<sup>26</sup> which developed the basics equations. This problem is related to many industrial process and is fundamental in understanding many industrial processes. Furthermore, this analysis is a building bloc for heat and mass transfer understanding<sup>27</sup>.

<sup>26</sup>German mechanical engineer, Ernst Kraft Wilhelm Nusselt born November 25, 1882 September 1, 1957 in Munchen

<sup>27</sup>Extensive discussion can be found in this author master thesis. Comprehensive discussion about this problem can be found this author Master thesis.



Example 8.9:

In many situations in nature and many industrial processes liquid flows downstream

on inclined plate at  $\theta$  as shown in Figure 8.20. For this example, assume that the gas density is zero (located outside the liquid domain). Assume that “scale” is large enough so that the “no slip” condition prevail at the plate (bottom). For simplicity, assume that the flow is two dimensional. Assume that the flow obtains a steady state after some length (and the acceleration vanished). The dominate force is the gravity. Write the governing equations for this situation. Calculate the velocity profile. Assume that the flow is one dimensional in the  $x$  direction.

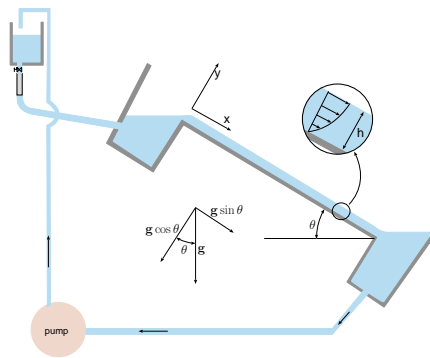

Fig. -8.20. Mass flow due to temperature difference for example 8.1

SOLUTION

This problem is suitable to Cartesian coordinates in which  $x$  coordinate is pointed in the flow direction and  $y$  perpendicular to flow direction (depicted in Figure 8.20). For this system, the gravity in the  $x$  direction is  $g \sin \theta$  while the direction of  $y$  the gravity is  $g \cos \theta$ . The governing in the  $x$  direction is

$$\rho \left( \overbrace{\frac{\partial U_x}{\partial t}}^{\neq f(t)} + U_x \overbrace{\frac{\partial U_x}{\partial x}}^{=0} + \overbrace{U_y}^{=0} \frac{\partial U_x}{\partial y} + \overbrace{U_z}^{-0} \frac{\partial U_x}{\partial z} \right) = - \overbrace{\frac{\partial P}{\partial x}}^{\sim 0} + \mu \left( \overbrace{\frac{\partial^2 U_x}{\partial x^2}}^{=0} + \frac{\partial^2 U_x}{\partial y^2} + \overbrace{\frac{\partial^2 U_x}{\partial z^2}}^{=0} \right) + \rho \overbrace{\frac{g \sin \theta}{g_x}}$$

(8.IX.a)

The first term of the acceleration is zero because the flow is in a steady state. The first term of the convective acceleration is zero under the assumption of this example flow is fully developed and hence not a function of  $x$  (nothing to be “improved”). The second and the third terms in the convective acceleration are zero because the velocity at that direction is zero ( $U_y = U_z = 0$ ). The pressure is almost constant along the  $x$  coordinate. As it will be shown later, the pressure loss in the gas phase (mostly air) is negligible. Hence the pressure at the gas phase is almost constant hence the pressure at the interface in the liquid is constant. The surface has no curvature and hence the pressure at liquid side similar to the gas phase and the only change in liquid is in the  $y$  direction. Fully developed flow means that the first term of the velocity Laplacian is

zero ( $\frac{\partial U_x}{\partial x} \equiv 0$ ). The last term of the velocity Laplacian is zero because no velocity in the  $z$  direction.

Thus, equation (8.IX.a) is reduced to

$$0 = \mu \frac{\partial^2 U_x}{\partial y^2} + \rho g \sin \theta \quad (8.IX.b)$$

With boundary condition of “no slip” at the bottom because the large scale and steady state

$$U_x(y=0) = 0 \quad (8.IX.c)$$

The boundary at the interface is simplified to be

$$\left. \frac{\partial U_x}{\partial y} \right|_{y=0} = \tau_{air} (\sim 0) \quad (8.IX.d)$$

If there is additional requirement, such a specific velocity at the surface, the governing equation can not be sufficient from the mathematical point of view. Integration of equation (8.IX.b) yields

$$\frac{\partial U_x}{\partial y} = \frac{\rho}{\mu} g \sin \theta y + c_1 \quad (8.IX.e)$$

The integration constant can be obtain by applying the condition (8.IX.d) as

$$\tau_{air} = \mu \left. \frac{\partial U_x}{\partial y} \right|_h = -\rho g \sin \theta \underbrace{h}_y + c_1 \mu \quad (8.IX.f)$$

Solving for  $c_1$  results in

$$c_1 = \frac{\tau_{air}}{\mu} + \frac{1}{\underbrace{\nu}_{\frac{\mu}{\rho}}} g \sin \theta h \quad (8.IX.g)$$

The second integration applying the second boundary condition yields  $c_2 = 0$  results in

$$U_x = \frac{g \sin \theta}{\nu} (2 y h - y^2) - \frac{\tau_{air}}{\mu} \quad (8.IX.h)$$

When the shear stress caused by the air is neglected, the velocity profile is

$$U_x = \frac{g \sin \theta}{\nu} (2 h y - y^2) \quad (8.IX.i)$$

The flow rate per unit width is

$$\frac{Q}{W} = \int_A U_x dA = \int_0^h \left( \frac{g \sin \theta}{\nu} (2 h y - y^2) - \frac{\tau_{air}}{\mu} \right) dy \quad (8.IX.j)$$

Where  $W$  here is the width into the page of the flow. Which results in

$$\frac{Q}{W} = \frac{g \sin \theta}{\nu} \frac{2 h^3}{3} - \frac{\tau_{air} h}{\mu} \quad (8.IX.k)$$

The average velocity is then

$$\overline{U}_x = \frac{Q}{h} = \frac{g \sin \theta}{3\nu} \frac{2h^2}{3} - \frac{\tau_{air}}{\mu} \tag{8.IX.1}$$

Note the shear stress at the interface can be positive or negative and hence can increase or decrease the flow rate and the averaged velocity.

End Solution

In the following following example the issue of driving force of the flow through curved interface is examined. The flow in the kerosene lamp is depends on the surface tension. The flow surface is curved and thus pressure is not equal on both sides of the interface.

Example 8.10:

*A simplified flow version the kerosene lump is of liquid moving up on a solid core. Assume that radius of the liquid and solid core are given and the flow is at steady state. Calculate the minimum shear stress that required to operate the lump (alternatively, the maximum height).*

### 8.7.1 Interfacial Instability

In Example 8.9 no requirement was made as for the velocity at the interface (the upper boundary). The vanishing shear stress at the interface was the only requirement was applied. If the air is considered two governing equations must be solved one for the air (gas) phase and one for water (liquid) phase. Two boundary conditions must be satisfied at the interface. For the liquid, the boundary condition of “no slip” at the bottom surface of liquid must be satisfied. Thus, there is total of three boundary conditions<sup>28</sup> to be satisfied. The

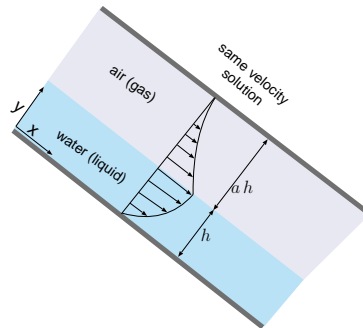

Fig. -8.21. Flow of liquid in partially filled duct.

solution to the differential governing equations provides only two constants. The second domain (the gas phase) provides another equation with two constants but again three boundary conditions need to be satisfied. However, two of the boundary conditions for these equations are identical and thus the six boundary conditions are really only 4 boundary conditions.

<sup>28</sup> The author was hired to do experiments on thin film (gravity flow). These experiments were to study the formation of small and big waves at the interface. The phenomenon is explained by the fact that there is somewhere instability which is transferred into the flow. The experiments were conducted on a solid concrete laboratory and the flow was in a very stable system. No matter how low flow rate was small and big occurred. This explanation bothered this author, thus current explanation was developed to explain the wavy phenomenon occurs.

The governing equation solution<sup>29</sup> for the gas phase ( $h \geq y \geq a$ ) is

$$U_{xg} = \frac{g \sin \theta}{2\nu_g} y^2 + c_1 y + c_2 \quad (8.151)$$

Note, the constants  $c_1$  and  $c_2$  are dimensional which mean that they have physical units ( $c_1 \rightarrow [1/sec]$ ) The governing equation in the liquid phase ( $0 \leq y \leq h$ ) is

$$U_{x\ell} = \frac{g \sin \theta}{2\nu_\ell} y^2 + c_3 y + c_4 \quad (8.152)$$

The gas velocity at the upper interface is vanished thus

$$U_{xg} [(1+a)h] = 0 \quad (8.153)$$

At the interface the “no slip” condition is regularly applied and thus

$$U_{xg}(h) = U_{x\ell}(h) \quad (8.154)$$

Also at the interface (a straight surface), the shear stress must be continuous

$$\mu_g \frac{\partial U_{xg}}{\partial y} = \mu_\ell \frac{\partial U_{x\ell}}{\partial y} \quad (8.155)$$

Assuming “no slip” for the liquid at the bottom boundary as

$$U_{x\ell}(0) = 0 \quad (8.156)$$

The boundary condition (8.153) results in

$$0 = \frac{g \sin \theta}{2\nu_g} h^2 (1+a)^2 + c_1 h (1+a) + c_2 \quad (8.157)$$

The same can be said for boundary condition (8.156) which leads

$$c_4 = 0 \quad (8.158)$$

Applying equation (8.155) yields

$$\overbrace{\frac{\mu_g}{\nu_g}}^{\rho_g} g \sin \theta h + c_1 \mu_g = \overbrace{\frac{\mu_\ell}{\nu_\ell}}^{\rho_\ell} g \sin \theta h + c_3 \mu_\ell \quad (8.159)$$

Combining boundary conditions equation(8.154) with (8.157) results in

$$\frac{g \sin \theta}{2\nu_g} h^2 + c_1 h + c_2 = \frac{g \sin \theta}{2\nu_\ell} h^2 + c_3 h \quad (8.160)$$

<sup>29</sup>This equation results from double integrating of equation (8.IX.b) and substitling  $\nu = \mu/\rho$ .

— — — — — *Advance material can be skipped* — — — — —

The solution of equation (8.157), (8.159) and (8.160) is obtained by computer algebra (see in the code) to be

$$\begin{aligned}
 c_1 &= -\frac{\sin \theta (g h \rho_g (2 \rho_g \nu_\ell \rho_\ell + 1) + a g h \nu_\ell)}{\rho_g (2 a \nu_\ell + 2 \nu_\ell)} \\
 c_2 &= \frac{\sin \theta (g h^2 \rho_g (2 \rho_g \nu_\ell \rho_\ell + 1) - g h^2 \nu_\ell)}{2 \rho_g \nu_\ell} \\
 c_3 &= \frac{\sin \theta (g h \rho_g (2 a \rho_g \nu_\ell \rho_\ell - 1) - a g h \nu_\ell)}{\rho_g (2 a \nu_\ell + 2 \nu_\ell)}
 \end{aligned} \tag{8.161}$$

— — — — — *End Advance material* — — — — —

When solving this kinds of mathematical problem the engineers reduce it to minimum amount of parameters to reduce the labor involve. So equation (8.157) transformed by some simple rearrangement to be

$$(1 + a)^2 = \frac{\overbrace{2 \nu_g c_1}^{C_1}}{g h \sin \theta} + \frac{\overbrace{2 c_2 \nu_g}^{C_2}}{g h^2 \sin \theta} \tag{8.162}$$

And equation (8.159)

$$1 + \frac{\overbrace{\nu_g c_1}^{\frac{1}{2} C_1}}{g h \sin \theta} = \frac{\rho_\ell}{\rho_g} + \frac{\overbrace{\frac{1}{2} \frac{\mu_\ell}{\mu_g} C_3}^{\frac{1}{2} \frac{\mu_\ell}{\mu_g} C_3}}{\mu_g g h \sin \theta} \tag{8.163}$$

and equation (8.160)

$$1 + \frac{2 \nu_g \cancel{h} c_1}{h^{\cancel{2}} g \sin \theta} + \frac{2 \nu_g c_2}{h^2 g \sin \theta} = \frac{\nu_g}{\nu_\ell} + \frac{2 \nu_g \cancel{h} c_3}{g h^{\cancel{2}} \sin \theta} \tag{8.164}$$

Or rearranging equation (8.164)

$$\frac{\nu_g}{\nu_\ell} - 1 = \frac{\overbrace{2 \nu_g c_1}^{C_1}}{h g \sin \theta} + \frac{\overbrace{2 \nu_g c_2}^{C_2}}{h^2 g \sin \theta} - \frac{\overbrace{2 \nu_g c_3}^{C_3}}{g h \sin \theta} \tag{8.165}$$

This presentation provide similarity and it will be shown in the Dimensional analysis chapter better physical understanding of the situation. Equation (8.162) can be written as

$$(1 + a)^2 = C_1 + C_2 \tag{8.166}$$

Further rearranging equation (8.163)

$$\frac{\rho_\ell}{\rho_g} - 1 = \frac{C_1}{2} - \frac{\mu_\ell}{\mu_g} \frac{C_3}{2} \quad (8.167)$$

and equation (8.165)

$$\frac{\nu_g}{\nu_\ell} - 1 = C_1 + C_2 - C_3 \quad (8.168)$$

This process that was shown here is referred as non-dimensionalization<sup>30</sup>. The ratio of the dynamics viscosity can be eliminated from equation (8.168) to be

$$\frac{\mu_g}{\mu_\ell} \frac{\rho_\ell}{\rho_g} - 1 = C_1 + C_2 - C_3 \quad (8.169)$$

The set of equation can be solved for the any ratio of the density and dynamic viscosity. The solution for the constant is

$$C_1 = \frac{\rho_g}{\rho_\ell} - 2 + a^2 + 2a \frac{\mu_g}{\mu_\ell} + 2 \frac{\mu_g}{\mu_\ell} \quad (8.170)$$

$$C_2 = \frac{-\frac{\mu_g}{\mu_\ell} \frac{\rho_\ell}{\rho_g} + a \left( 2 \frac{\mu_g}{\mu_\ell} - 2 \right) + 3 \frac{\mu_g}{\mu_\ell} + a^2 \left( \frac{\mu_g}{\mu_\ell} - 1 \right) - 2}{\frac{\mu_g}{\mu_\ell}} \quad (8.171)$$

$$C_3 = -\frac{\mu_g}{\mu_\ell} \frac{\rho_\ell}{\rho_g} + a^2 + 2a + 2 \quad (8.172)$$

The two different fluids<sup>31</sup> have flow have a solution as long as the distance is finite reasonable similar. What happen when the lighter fluid, mostly the gas, is infinite long. This is one of the source of the instability at the interface. The boundary conditions of flow with infinite depth is that flow at the interface is zero, flow at infinite is zero. The requirement of the shear stress in the infinite is zero as well. There is no way obtain one dimensional solution for such case and there is a component in the  $y$  direction. Combining infinite size domain of one fluid with finite size on the other one side results in unstable interface.

<sup>30</sup>Later it will be move to the Dimensional Chapter

<sup>31</sup>This topic will be covered in dimensional analysis in more extensively. The point here the understanding issue related to boundary condition not per se solution of the problem.

---

---

# CHAPTER 9

---

## Dimensional Analysis

*This chapter is dedicated to my adviser, Dr. E.R.G. Eckert.*

*Genick Bar-Meir*

### 9.1 Introductory Remarks

Dimensional analysis refers to techniques dealing with units or conversion to a unitless system. The definition of dimensional analysis is not consistent in the literature which span over various fields and times. Possible topics that dimensional analysis deals with are consistency of the units, change order of magnitude, applying from the old and known to unknown (see the Book of Ecclesiastes), and creation of group parameters without any dimensions. In this chapter, the focus is on the applying the old to unknown as different scales and the creation of dimensionless groups. These techniques gave birth to dimensional parameters which have a great scientific importance. Since the 1940s<sup>1</sup>, the dimensional analysis is taught and written in all fluid mechanics textbooks. The approach or the technique used in these books is referred to as Buckingham- $\pi$ -theory. The  $\pi$ -theory was coined by Buckingham. However, there is another technique which is referred to in the literature as the Nusselt's method. Both these methods attempt to reduce the number of parameters which affect the problem and reduce the labor in solving the problem. The key in these techniques lays in the fact of consistency of the dimensions of any possible governing equation(s) and the fact that some dimensions are reoccurring. The Buckingham- $\pi$  goes further and no equations are solved and even no knowledge about these equations is required. In Buckingham's technique only the

---

<sup>1</sup>The history of dimensional analysis is complex. Several scientists used this concept before Buckingham and Nusselt (see below history section). Their work culminated at the point of publishing the paper Buckingham's paper and independently constructed by Nusselt. It is interesting to point out that there are several dimensionless numbers that bear Nusselt and his students name, Nusselt number, Schmidt number, Eckert number. There is no known dimensionless number which bears Buckingham name. Buckingham's technique is discussed and studied in Fluid Mechanics while almost completely ignored by Heat and Mass Transfer researchers and their classes. Furthermore, in many advance fluid mechanics classes Nusselt's technique is used and Buckingham's technique is abandoned. Perhaps this fact can be attributed to tremendous influence Nusselt and his students had on the heat transfer field. Even, this author can be accused for being bias as the Eckert's last student. However, this author observed that Nusselt's technique is much more effective as it will demonstrated later.

dimensions or the properties of the problem at hand are analyzed. This author is aware of only a single class of cases where Buckingham's methods is useful and or can solve the problem namely the pendulum class problem (and similar).

The dimensional analysis was independently developed by Nusselt and improved by his students/co workers (Schmidt, Eckert) in which the governing equations are used as well. Thus, more information is put into the problem and thus a better understanding on the dimensionless parameters is extracted. The advantage or disadvantage of these similar methods depend on the point of view. The Buckingham- $\pi$  technique is simpler while Nusselt's technique produces a better result. Sometime, the simplicity of Buckingham's technique yields insufficient knowledge or simply becomes useless. When no governing equations are found, Buckingham's method has usefulness. It can be argued that these situations really do not exist in the Thermo-Fluid field. Nusselt's technique is more cumbersome but more precise and provide more useful information. Both techniques are discussed in this book. The advantage of the Nusselt's technique are: a) compact presentation, b) knowledge what parameters affect the problem, c) easier to extent the solution to more general situations. In very complex problems both techniques suffer from inability to provide a significant information on the effective parameters such multi-phase flow etc.

It has to be recognized that the dimensional analysis provides answer to what group of parameters affecting the problem and not the answer to the problem. In fact, there are fields in thermo-fluid where dimensional analysis, is recognized as useless. For example, the area of multiphase flows there is no solution based on dimensionless parameters (with the exception of the rough solution of Martinelli). In the Buckingham's approach it merely suggests the number of dimensional parameters based on a guess of all parameters affecting the problem. Nusselt's technique provides the form of these dimensionless parameters, and the relative relationship of these parameters.

### 9.1.1 Brief History

The idea of experimentation with a different, rather than the actual, dimension was suggested by several individuals independently. Some attribute it to Newton (1686) who coined the phrase of "great Principle of Similitude." Later, Maxwell a Scottish Physicist played a major role in establishing the basic units of mass, length, and time as building blocks of all other units. Another example, John Smeaton (8 June 1724–28 October 1792) was an English civil and mechanical engineer who study relation between propeller/wind mill and similar devices to the pressure and velocity of the driving forces.

Jean B. J. Fourier (1768-1830) first attempted to formulate the dimensional analysis theory. This idea was extend by William Froude (1810-1871) by relating the modeling of open channel flow and actual body but more importantly the relationship between drag of models to actual ships. While the majority of the contributions were done by thermo-fluid guys the concept of the equivalent or similar propagated to other fields. Aiméem Vaschy, a German Mathematical Physicist (1857–1899), suggested using similarity in electrical engineering and suggested the Norton circuit equivalence theorems. Rayleigh probably was the first one who used dimensional analysis (1872) to obtain



the relationships between the physical quantities (see the question why the sky is blue story).

Osborne Reynolds (1842–1912) was the first to derive and use dimensionless parameters to analyze experimental data. Riabouchunsky<sup>2</sup> proposed of relating temperature by molecules velocity and thus creating dimensionless group with the byproduct of compact solution (solution presented in a compact and simple form).

Buckingham culminated the dimensional analysis and similitude and presented it in a more systematic form. In the about the same time (1915, Wilhelm Nusselt (November 25, 1882 – September 1, 1957), a German engineer, developed the dimensional analysis (proposed the principal parameters) of heat transfer without knowledge about previous work of Buckingham.

### 9.1.2 Theory Behind Dimensional Analysis

In chemistry it was recognized that there are fundamental elements that all the material is made from (the atoms). That is, all the molecules are made from a combination of different atoms. Similarly to this concept, it was recognized that in many physical systems there are basic fundamental units which can describe all the other dimensions or units in the system. For example, isothermal single component systems (which does not undergo phase change, temperature change and observed no magnetic or electrical effect) can be described by just basic four physical units. The units or dimensions are, time, length, mass, quantity of substance (mole). For example, the dimension or the units of force can be constructed utilizing Newton's second law i.e. mass times acceleration  $\rightarrow m a = M L/t^2$ . Increase of degree of freedom, allowing this system to be non-isothermal will increase only by one additional dimension of temperature,  $\theta$ . These five fundamental units are commonly the building blocks for most of the discussion in fluid mechanics (see Table of basic units 9.1).

Table -9.1. Basic Units of Two Common Systems

Standard System			Old System		
Name	Letter	Units	Name	Letter	Units
Mass	$M$	[kg]	Force	$F$	[N]
Length	$L$	[m]	Length	$L$	[m]
Time	$t$	[sec]	Time	$t$	[sec]
Temperature	$\theta$	[°C]	Temperature	$T$	[°C]
Additional Basic Units for Magnetohydrodynamics					
Continued on next page					

<sup>2</sup>Riabouchunsky, Nature Vol 99 p. 591, 1915

Table -9.1. Basic Units of Two Common Systems (continue)

Standard System			Old System		
Name	Letter	Units	Name	Letter	Units
Electric Current	<i>A</i>	[A]mpere	Electric Current	<i>A</i>	[A]mpere
Luminous Intensity	<i>cd</i>	[cd] candle	Luminous Intensity	<i>cd</i>	[cd] candle
Chemical Reactions					
Quantity of substance	$\mathfrak{M}$	<i>mol</i>	Quantity of substance	$\mathfrak{M}$	<i>mol</i>

The choice of these basic units is not unique and several books and researchers suggest a different choice of fundamental units. One common selection is substituting the mass with the force in the previous selection (F, t, L, mol, Temperature). This author is not aware of any discussion on the benefits of one method over the other method. Yet, there are situations in which first method is better than the second one while in other situations, it can be the reverse. In this book, these two selections are presented. Other selections are possible but not common and, at the moment, will not be discussed here.

#### Example 9.1:

What are the units of force when the basic units are: mass, length, time, temperature ( $M, L, t, \theta$ )? What are the units of mass when the basic units are: force, length, time, temperature ( $F, L, t, T$ )? Notice the different notation for the temperature in the two systems of basic units. This notation has no significance but for historical reasons remained in use.

#### SOLUTION

These two systems are related as the questions are the reversed of each other. The connection between the mass and force can be obtained from the simplified Newton's second law  $F = m a$  where  $F$  is the force,  $m$  is the mass, and  $a$  is the acceleration. Thus, the units of force are

$$F = \frac{M L}{t^2} \quad (9.1.a)$$

For the second method the unit of mass are obtain from Equation (9.1.a) as

$$M = \frac{F t^2}{L} \quad (9.1.b)$$

---

End Solution

---

The number of fundamental or basic dimensions determines the number of the combinations which affect the physical<sup>3</sup> situations. The dimensions or units which affect the problem at hand can be reduced because these dimensions are repeating or reoccurring. The Buckingham method is based on the fact that all equations must be consistent with their units. That is the left hand side and the right hand side have to have the same units. Because they have the same units the equations can be divided to create unitless equations. This idea alludes to the fact that these unitless parameters can be found without any knowledge of the governing equations. Thus, the arrangement of the effecting parameters in unitless groups yields the affecting parameters. These unitless parameters are the dimensional parameters. The following trivial example demonstrates the consistency of units

Example 9.2:

*Newton's equation has two terms that related to force  $F = m a + \dot{m} U$ . Where  $F$  is force,  $m$  is the mass,  $a$  is the acceleration and dot above  $\dot{m}$  indicating the mass derivative with respect to time. In particular case, this equation get a form of*

$$F = m a + \gamma \quad (9.11.a)$$

*where  $\gamma$  represent the second term. What are the requirement on equation (9.11.a)?*

SOLUTION

Clearly, the units of  $[F]$ ,  $m a$  and  $\gamma$  have to be same. The units of force are  $[N]$  which is defined by first term of the right hand side. The same units force has to be applied to  $\gamma$  thus it must be in  $[N]$ .

---

End Solution

---

### 9.1.3 Dimensional Parameters Application for Experimental Study

The solutions for any situations which are controlled by the same governing equations with same boundary conditions regardless of the origin the equation. The solutions are similar or identical regardless to the origin of the field no matter if the field is physical, or economical, or biological. The Buckingham's technique implicitly suggested that since the governing equations (in fluid mechanics) are essentially are the same, just knowing the parameters is enough the identify the problem. This idea alludes to connections between similar parameters to similar solution. The non-dimensionalization i.e. operation of reducing the number affecting parameters, has a useful by-product, the analogy in other words, the solution by experiments or other cases. The analogy or similitude refers to understanding one phenomenon from the study of another phenomenon. This technique is employed in many fluid mechanics situations. For example, study of compressible flow (a flow where the density change plays a significant part) can be achieved

<sup>3</sup>The dimensional analysis also applied in economics and other areas and the statement should reflect this fact. However, this book is focused on engineering topics and other fields are not discussed.

by study of surface of open channel flow. The compressible flow is also similar to traffic on the highway. Thus for similar governing equations if the solution exists for one case it is a solution to both cases.

The analogy can be used to conduct experiment in a cheaper way and/or a safer way. Experiments in different scale than actual dimensions can be conducted for cases where the actual dimensions are difficult to handle. For example, study of large air planes can done on small models. On the other situations, larger models are used to study small or fast situations. This author believes that at the present the Buckingham method has extremely limited use for the real world and yet this method is presented in the classes on fluid mechanics. Thus, many examples on the use of this method will be presented in this book. On the other hand, Nusselt's method has a larger practical use in the real world and therefore will be presented for those who need dimensional analysis for the real world. Dimensional analysis is useful also for those who are dealing with the numerical research/calculation. This method supplement knowledge when some parameters should be taken into account and why.

Fitting a rod into a circular hole (see Figure 9.1) is an example how dimensional analysis can be used. To solve this problem, it is required to know two parameters; 1) the rode diameter and 2) the diameter of the hole. Actually, it is required to have only one parameter, the ratio of the rode diameter to the hole diameter. The ratio is a dimensionless number and with this number one can tell that for a ratio larger than one, the rode will not enter the hole;

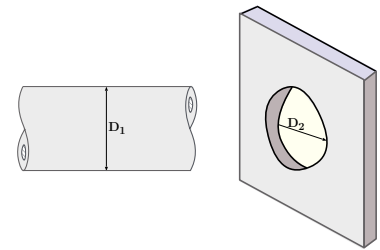

Fig. -9.1. Fitting rod into a hole.

and a ratio smaller than one, the rod is too small. Only when the ratio is equal to one, the rode is said to be fit. This presentation allows one to draw or present the situation by using only one coordinate, the radius ratio. Furthermore, if one wants to deal with tolerances, the dimensional analysis can easily be extended to say that when the ratio is equal from 0.99 to 1.0 the rode is fitting, and etc. If one were to use the two diameters description, further significant information will be needed. In the preceding simplistic example, the advantages are minimal. In many real problems this approach can remove cluttered views and put the problem into focus. Throughout this book the reader will notice that the systems/equations in many cases are converted to a dimensionless form to augment understanding.

#### 9.1.4 The Pendulum Class Problem

The only known problem that dimensional analysis can solve (to some degree) is the pendulum class problem. In this section several examples of the pendulum type problem are presented. The first example is the classic Pendulum problem.

Example 9.3:

Derive the relationship for the gravity [ $g$ ], frequency [ $\omega$ ] and length of pendulum [ $\ell$ ]. Assume that no other parameter including the mass affects the problem. That is, the relationship can be expressed as

$$\omega = f(\ell, g) \tag{9.III.a}$$

Notice in this problem, the real knowledge is provided, however in the real world, this knowledge is not necessarily given or known. Here it is provided because the real solution is already known from standard physics classes.<sup>4</sup>

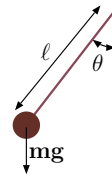

Fig. -9.2. Figure for example 9.3

SOLUTION

The solution technique is based on the assumption that the indexical form is the appropriate form to solve the problem. The Indexical form

$$\omega = C_1 \times \ell^a g^b \tag{9.III.b}$$

The solution functional complexity is limited to the basic combination which has to be in some form of multiplication of  $\ell$  and  $g$  in some power. In other words, the multiplication of  $\ell g$  have to be in the same units of the frequency units. Furthermore, assuming, for example, that a trigonometric function relates  $\ell$  and  $g$  and frequency. For example, if a sin function is used, then the functionality looks like  $\omega = \sin(\ell g)$ . From the units point of view, the result of operation not match i.e. ( $sec \neq \sin(sec)$ ). For that reason the form in equation (9.III.b) is selected. To satisfy equation (9.III.b) the units of every term are examined and summarized the following table.

Table -9.2. Units of the Pendulum Parameters

Parameter	Units	Parameter	Units	Parameter	Units
$\omega$	$t^{-1}$	$\ell$	$L^1$	$g$	$L^1 t^{-2}$

Thus substituting of the Table 9.7 in equation (9.III.b) results in

$$t^{-1} = C_1 (L^1)^a (L^1 t^{-2})^b \implies L^{a+b} t^{-2b} \tag{9.III.c}$$

after further rearrangement by multiply the left hand side by  $L^0$  results in

$$L^0 t^{-1} = C L^{a+b} t^{-2b} \tag{9.III.d}$$

<sup>4</sup>The reader can check if the mass is assumed to affect the problem then, the result is different.

In order to satisfy equation (9.III.d), the following must exist

$$0 = a + b \quad \text{and} \quad -1 = \frac{-2}{b} \quad (9.III.e)$$

The solution of the equations (9.III.e) is  $a = -1/2$  and  $b = -1/2$ . Thus, the solution is in the form of

$$\omega = C_1 \ell^{1/2} g^{-1/2} = C_1 \sqrt{\frac{g}{\ell}} \quad (9.III.f)$$

It can be observed that the value of  $C_1$  is unknown. The pendulum frequency is known to be

$$\omega = \frac{1}{2\pi} \sqrt{\frac{g}{\ell}} \quad (9.III.g)$$

---

End Solution

---

What was found in this example is the form of the solution's equation and frequency. Yet, the functionality e.g. the value of the constant was not found. The constant can be obtained from experiment for plotting  $\omega$  as the abscissa and  $\sqrt{\ell/g}$  as ordinate.

According to some books and researchers, this part is the importance of the dimensional analysis. It can be noticed that the initial guess merely and actually determine the results. If, however, the mass is added to considerations, a different result will be obtained. If the guess is relevant and correct then the functional relationship can be obtained by experiments.

## 9.2 Buckingham- $\pi$ -Theorem

All the physical phenomena that is under the investigation have  $n$  physical effecting parameters such that

$$F_1(q_1, q_2, q_3, \dots, q_n) = 0 \quad (9.1)$$

where  $q_i$  is the " $i$ " parameter effecting the problem. For example, study of the pressure difference created due to a flow in a pipe is a function of several parameters such

$$\Delta P = f(L, D, \mu, \rho, U) \quad (9.2)$$

In this example, the chosen parameters are not necessarily the most important parameters. For example, the viscosity,  $\mu$  can be replaced by dynamic viscosity,  $\nu$ . The choice is made normally as the result of experience and it can be observed that  $\nu$  is a function of  $\mu$  and  $\rho$ . Finding the important parameters is based on "good fortune" or perhaps intuition. In that case, a new function can be defined as

$$F(\Delta P, L, D, \mu, \rho, U) = 0 \quad (9.3)$$

Again as stated before, the study of every individual parameter will create incredible amount of data. However, Buckingham's<sup>5</sup> methods suggested to reduce the number of

<sup>5</sup>E. Buckingham, "Model Experiments and the Forms of Empirical Equations," Transactions of the American Society of Mechanical Engineers, Vol. 37, 1915.

parameters. If independent parameters of same physical situation is  $m$  thus in general it can be written as

$$F_2(\pi_1, \pi_2, \pi_3, \dots, \pi_m) = 0 \quad (9.4)$$

If there are  $n$  variables in a problem and these variables contain  $m$  primary dimensions (for example M, L, T), then the equation relating all the variables will have  $(n-m)$  dimensionless groups.

There are 2 conditions on the dimensionless parameters:

1. Each of the fundamental dimensions must appear in at least one of the  $m$  variables
2. It must not be possible to form a dimensionless group from one of the variables within a recurring set. A recurring set is a group of variables forming a dimensionless group.

In the case of the pressure difference in the pipe (Equation (9.3)) there are 6 variables or  $n = 6$ . The number of the fundamental dimensions is 3 that is  $m = 3$  ([M], [L], [t]) The choice of fundamental or basic units is arbitrary in that any construction of these units is possible. For example, another combination of the basic units is time, force, mass is a proper choice. According to Buckingham's theorem the number of dimensionless groups is  $n - m = 6 - 3 = 3$ . It can be written that one dimensionless parameter is a function of two other parameters such as

$$\pi_1 = f(\pi_2, \pi_3) \quad (9.5)$$

If indeed such a relationship exists, then, the number of parameters that control the problem is reduced and the number of experiments that need to be carried is considerably smaller. Note, the  $\pi$ -theorem does not specify how the parameters should be selected nor what combination is preferred.

### 9.2.1 Construction of the Dimensionless Parameters

In the construction of these parameters it must be realized that every dimensionless parameters has to be independent. The meaning of independent is that one dimensionless parameter is not a multiply or a division of another dimensional parameter. In the above example there are three dimensionless parameters which required of at least one of the physical parameter per each dimensionless parameter. Additionally, to make these dimensionless parameters independent they cannot be multiply or division of each other.

For the pipe problem above,  $\ell$  and  $D$  have the same dimension and therefore both cannot be chosen as they have the same dimension. One possible combination is of  $D$ ,  $U$  and  $\rho$  are chosen as the recurring set. The dimensions of these physical variables are:  $D = [L^1]$ , velocity of  $U = [L t^{-1}]$  and density as  $\rho = [M L^{-3}]$ . Thus, the first term  $D$  can provide the length,  $[L]$ , the second term,  $U$ , can provide the time  $[t]$ , and the third term,  $\rho$  can provide the mass  $[M]$ . The fundamental units,  $L$ ,  $t$ , and  $M$  are length, time and mass respectively. The fundamental units can be written in

terms of the physical units. The first term  $L$  is the described by  $D$  with the units of  $[L]$ . The time,  $[t]$ , can be expressed by  $D/U$ . The mass,  $[M]$ , can be expressed by  $\rho D^3$ . Now the dimensionless groups can be constructed by looking at the remaining physical parameters,  $\Delta P$ ,  $D$  and  $\mu$ . The pressure difference,  $\Delta P$ , has dimensions of  $[M L^{-1} t^{-2}]$  Therefore,  $\Delta P M^{-1} L t^2$  is a dimensionless quantity and these values were calculated just above this line. Thus, the first dimensionless group is

$$\pi_1 = \underbrace{\Delta P}_{[M L^{-1} t^{-2}]} \underbrace{\frac{1}{\rho D^3}}_{[M^{-1}]} \underbrace{D}_{[L]} \underbrace{\frac{D^2}{U^2}}_{[t^2]} = \underbrace{\frac{\Delta P}{\rho U^2}}_{\text{unitless}} \quad (9.6)$$

The second dimensionless group (using  $D$ ) is

$$\pi_2 = \underbrace{\frac{D}{D}}_{[L]} \underbrace{\frac{1}{\ell^{-1}}}_{[L^{-1}]} = \frac{D}{L} \quad (9.7)$$

The third dimensionless group (using  $\mu$  dimension of  $[M L^{-1} t^{-1}]$ ) and therefore dimensionless is

$$\pi_3 = \mu \underbrace{\frac{1}{D^3 \rho}}_{[M^{-1}]} \underbrace{D}_{[L]} \underbrace{\frac{D}{U}}_{[t]} = \frac{\mu}{D U \rho} \quad (9.8)$$

This analysis is not unique and there can be several other possibilities for selecting dimensionless parameters which are “legitimately” correct for this approach.

There are roughly three categories of methods for obtaining the dimensionless parameters. The first one solving it in one shot. This method is simple and useful for a small number of parameters. Yet this method becomes complicated for large number of parameters. The second method, some referred to as the building blocks method, is described above. The third method is by using dimensional matrix which is used mostly by mathematicians and is less useful for engineering purposes.

The second and third methods require to identification of the building blocks. These building blocks are used to construct the dimensionless parameters. There are several requirements on these building blocks which were discussed on page 281. The main point that the building block unit has to contain at least the basic or fundamental unit. This requirement is logical since it is a building block. The last method is mostly used by mathematicians which leads and connects to linear algebra. The fact that this method used is the hall mark that the material was written by mathematician. Here, this material will be introduced for completeness sake with examples and several terms associated with this technique.

### 9.2.2 Basic Units Blocks

In Thermo–Fluid science there are several basic physical quantities which summarized in Table 9.1. In the table contains two additional physical/basic units that appear in



magneto hydrodynamics (not commonly use in fluid mechanics). Many (almost all) of the engineering dimensions used in fluid mechanics can be defined in terms of the four basic physical dimensions  $M$ ,  $L$ ,  $t$  and  $\theta$ . The actual basic units used can be S.I. such as kilograms, meters, seconds and Kelvins/Celsius or English system or any other system. In using basic new basic physical units,  $M$ ,  $L$ ,  $t$ , and  $\theta$  or the old system relieves the discussion from using particular system measurements. The density, for example, units are  $Mass/Length^3$  and in the new system the density will be expressed as  $M/L^3$  while in S.I.  $kg/m^3$  and English system it  $slug/ft^3$ . A common unit used in Fluid Mechanics is the Force, which expressed in SI as Newton [ $N$ ]. The Newton defined as a force which causes a certain acceleration of a specific mass. Thus, in the new system the force it will be defined as  $M L t^{-2}$ . There are many parameters that contains force which is the source reason why the old (or alternative) system use the force instead the mass.

There many physical units which are dimensionless by their original definition. Examples to “naturally” being dimensionless are the angle, strains, ratio of specific heats,  $k$ , friction coefficient,  $f$  and ratio of lengths. The angle represented by a ratio of two sides of a triangle and therefor has no units nor dimensions. Strain is a ratio of the change of length by the length thus has no units.

Quantities used in engineering can be reduced to six basic dimensions which are presented in Table 9.1. The last two are not commonly used in fluid mechanics and temperature is only used sometimes. Many common quantities are presented in the following Table 9.3.

Table -9.3. Physical units for two common systems. Note the second (time) in large size units appear as “s” while in small units as “sec.”

Standard System			Old System		
Name	Letter	Units	Name	Letter	Units
Area	$L^2$	$[m^2]$	Area	$L^2$	$[m^2]$
Volume	$L^3$	$[m^3]$	Volume	$L^3$	$[m^3]$
Angular velocity	$\frac{1}{t}$	$[\frac{1}{sec}]$	Angular velocity	$\frac{1}{t}$	$[\frac{1}{sec}]$
Acceleration	$\frac{L}{t^2}$	$[\frac{m}{sec^2}]$	Acceleration	$\frac{L}{t^2}$	$[\frac{m}{sec^2}]$
Angular acceleration	$\frac{1}{t^2}$	$[\frac{1}{sec^2}]$	Angular acceleration	$\frac{1}{t^2}$	$[\frac{1}{sec^2}]$
Force	$\frac{M L}{t^2}$	$[\frac{kg m}{sec^2}]$	Mass	$\frac{F t^2}{L}$	$[\frac{N s}{m}]$
Density	$\frac{M}{L^3}$	$[\frac{kg}{m^3}]$	Density	$\frac{F t^2}{L^4}$	$[\frac{kg}{m^3}]$

Continued on next page

Table -9.3. Basic Units of Two Common System (continue)

Standard System			Old System		
Name	Letter	Units	Name	Letter	Units
Momentum	$\frac{M L}{t}$	$\left[\frac{kg m}{sec}\right]$	Momentum	$F t$	$[N sec]$
Angular Momentum	$\frac{M L^2}{t}$	$\left[\frac{kg m^2}{sec}\right]$	Angular Momentum	$L F t$	$[m N s]$
Torque	$\frac{M L^2}{t^2}$	$\left[\frac{kg m}{sec^2}\right]$	Torque	$L F$	$[m N]$
Absolute Viscosity	$\frac{M}{L^1 t^1}$	$\left[\frac{kg}{m s}\right]$	Absolute Viscosity	$\frac{t F}{L^2}$	$\left[\frac{N s}{m^2}\right]$
Kinematic Viscosity	$\frac{L^2}{t^1}$	$\left[\frac{m^2}{sec}\right]$	Kinematic Viscosity	$\frac{L^2}{t}$	$\left[\frac{m^3}{sec}\right]$
Volume flow rate	$\frac{L^3}{t^1}$	$[sec]$	Volume flow rate	$\frac{L^3}{t^1}$	$\left[\frac{m^3}{sec}\right]$
Mass flow rate	$\frac{M}{t^1}$	$\left[\frac{kg}{sec}\right]$	Mass flow rate	$\frac{F t}{L^1}$	$\left[\frac{N s}{m}\right]$
Pressure	$\frac{M}{L t^2}$	$\left[\frac{kg}{m sec}\right]$	Pressure	$\frac{F}{L^2}$	$\left[\frac{N}{m^2}\right]$
Surface Tension	$\frac{M}{t^2}$	$\left[\frac{kg}{sec^2}\right]$	Surface Tension	$\frac{F}{L}$	$\left[\frac{N}{m}\right]$
Work or Energy	$\frac{M L^2}{t^2}$	$\left[\frac{kg m^2}{sec^2}\right]$	Work or Energy	$F L$	$[N m]$
Power	$\frac{M L^2}{t^3}$	$\left[\frac{kg m^2}{sec^3}\right]$	Power	$\frac{F L}{t^1}$	$\left[\frac{N m}{sec}\right]$
Thermal Conductivity	$\frac{M L^2}{t^3 \theta}$	$\left[\frac{kg m^2}{s^2 K}\right]$	Thermal Conductivity	$\frac{F}{t T}$	$\left[\frac{N}{m K}\right]$
Specific Heat	$\frac{L^2 \theta^2}{t^2}$	$\left[\frac{m^2}{s^2 K}\right]$	Specific Heat	$\frac{L^2 T^2}{t^2}$	$\left[\frac{m^2}{s^2 K}\right]$
Entropy	$\frac{M L^2}{t^2 \theta}$	$\left[\frac{kg m^2}{s^2 K}\right]$	Entropy	$\frac{F L^2}{T}$	$\left[\frac{kg m^2}{s^2 K}\right]$
Specific Entropy	$\frac{L^2}{t^2 \theta}$	$\left[\frac{m^2}{s^2 K}\right]$	Specific Entropy	$\frac{L^2}{t^2 T}$	$\left[\frac{m^2}{s^2 K}\right]$

Continued on next page

Table -9.3. Basic Units of Two Common System (continue)

Standard System			Old System		
Name	Letter	Units	Name	Letter	Units
Molar Specific Entropy	$\frac{L^2}{t^2 \theta}$	$\left[ \frac{kg\ m^2}{s^2\ K\ mol} \right]$	Molar Specific Entropy	$\frac{L^2}{T\ t^2}$	$\left[ \frac{kg\ m^2}{s^2\ K\ mol} \right]$
Enthalpy	$\frac{M\ L^2}{t^2}$	$\left[ \frac{kg\ m^2}{sec^2} \right]$	Enthalpy	$F\ L$	$[N\ m]$
Specific Enthalpy	$\frac{M^2}{t^2}$	$\left[ \frac{m^2}{sec^2} \right]$	Specific Enthalpy	$\frac{L^2}{t^2}$	$\left[ \frac{m^2}{sec^2} \right]$
Thermodynamic Force	$\frac{M\ L}{t^2\ \mathfrak{M}}$	$\left[ \frac{kg\ m}{sec^2\ mol} \right]$	Thermodynamic Force	$\frac{N}{\mathfrak{M}}$	$\left[ \frac{m^2}{sec^2} \right]$
Catalytic Activity	$\frac{\mathfrak{M}}{t}$	$\left[ \frac{mol}{sec} \right]$	Catalytic Activity	$\frac{\mathfrak{M}}{t}$	$\left[ \frac{mol}{sec} \right]$
heat transfer rate	$\frac{M\ L^2}{t^3}$	$\left[ \frac{kg\ m^2}{sec^2} \right]$	heat transfer rate	$\frac{L\ F}{t}$	$\left[ \frac{m\ N}{sec} \right]$

### 9.2.3 Implementation of Construction of Dimensionless Parameters

#### 9.2.3.1 One Shot Method: Constructing Dimensionless Parameters

In this method, the solution is obtained by assigning the powers to the affecting variables. The results are used to compare the powers on both sides of the equation. Several examples are presented to demonstrate this method.

Example 9.4:

An infinite cylinder is submerged and exposed to an external viscous flow. The researcher intuition suggests that the resistance to flow,  $R$  is a function of the radius  $r$ , the velocity  $U$ , the density,  $\rho$ , and the absolute viscosity  $\mu$ . Based on this limited information construct a relationship of the variables, that is

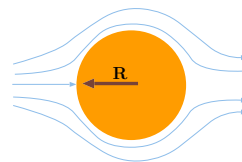

Fig. -9.3. Resistance of infinite cylinder.

$$R = f(r, U, \rho, \mu) \tag{9.IV.a}$$

SOLUTION

The functionality should be in a form of

$$R = f(r^a U^b \rho^c \mu^d) \quad (9.IV.b)$$

The units of the parameters are provided in Table 9.3. Thus substituting the data from the table into equation (9.IV.b) results in

$$\frac{\overbrace{ML}^R}{t^2} = Constant \left( \overbrace{\frac{r}{L}} \right)^a \left( \overbrace{\frac{U}{L}} \right)^b \left( \overbrace{\frac{\rho}{L^3}} \right)^c \left( \overbrace{\frac{\mu}{Lt}} \right)^d \quad (9.IV.c)$$

From equation (9.IV.c) the following requirements can be obtained

$$\begin{aligned} \text{time, } t \quad -2 &= -b - d \\ \text{mass, } M \quad 1 &= c + d \\ \text{length, } L \quad 1 &= a + b - 3c - d \end{aligned} \quad (9.IV.d)$$

In equations (9.IV.c) there are three equations and 4 unknowns. Expressing all the three variables in term of  $d$  to obtain

$$\begin{aligned} a &= 2 - d \\ b &= 2 - d \\ c &= 1 - d \end{aligned} \quad (9.IV.e)$$

Substituting equation (9.IV.e) into equation (9.IV.c) results in

$$R = Constant r^{2-d} U^{2-d} \rho^{1-d} \mu^d = Constant (\rho U^2 r^2) \left( \frac{\mu}{\rho U r} \right)^d \quad (9.IV.f)$$

Or rearranging equation yields

$$\frac{R}{\rho U^2 r^2} = Constant \left( \frac{\mu}{\rho U r} \right)^d \quad (9.IV.g)$$

The relationship between the two sides in equation (9.IV.g) is related to the two dimensionless parameters. In dimensional analysis the functionality is not clearly defined by but rather the function of the parameters. Hence, a simple way, equation (9.IV.g) can be represented as

$$\frac{R}{\rho U^2 r^2} = Constant f \left( \frac{\mu}{\rho U r} \right) \quad (9.IV.h)$$

where the power of  $d$  can be eliminated.

---

End Solution

---

An example of a ship<sup>6</sup> is a typical example where more than one dimensionless is to be constructed. Also introduction of dimensional matrix is presented.

Example 9.5:

*The modern ship today is equipped with a propeller as the main propulsion mechanism. The thrust,  $T$  is known to be a function of the radius,  $r$ , the fluid density,  $\rho$ , relative velocity of the ship to the water,  $U$ , rotation speed, rpm or  $N$ , and fluid viscosity,  $\mu$ . Assume that no other parameter affects the thrust, find the functionality of these parameters and the thrust.*

SOLUTION

The general solution under these assumptions leads to solution of

$$T = C r^a \rho^b U^c N^d \mu^e \quad (9.V.a)$$

It is convenient to arrange the dimensions and basic units in table. This table is referred to in the literature as the Dimensional matrix.

Table -9.4. Dimensional matrix

	<b>T</b>	<b>r</b>	<b><math>\rho</math></b>	<b>U</b>	<b>N</b>	<b><math>\mu</math></b>
M	1	0	1	0	0	1
L	1	1	-3	1	0	-1
t	-2	0	0	-1	-1	-1

Using the matrix results in

$$M L t^{-2} = L^a (L t)^b (M L^{-3})^c (t^{-t})^d (M L^{-1} t^{-t})^e \quad (9.V.b)$$

This matrix leads to three equations.

$$\begin{aligned} \text{Mass, } M & 1 = c + e \\ \text{Length, } L & 1 = a + b + -3c - e \\ \text{time, } t & -2 = -c - d - e \end{aligned} \quad (9.V.c)$$

---

<sup>6</sup>This author who worked as ship engineer during his twenties likes to present material related to ships.

The solution of this system is

$$\begin{aligned} a &= 2 + d - e \\ b &= 2 - d - e \\ c &= 1 - e \end{aligned} \quad (9.V.d)$$

Substituting the solution (9.V.d) into equation (9.V.a) yields

$$T = C r^{(2+d-e)} \rho^{(2-d-e)} U^{(1-e)} N^d \mu^f \quad (9.V.e)$$

Rearranging equation (9.V.e) provides

$$T = C \rho U^2 r^2 \left( \frac{\rho U r}{\mu} \right)^d \left( \frac{r N}{U} \right)^e \quad (9.V.f)$$

From dimensional analysis point of view the units under the power  $d$  and  $e$  are dimensionless. Hence, in general it can be written that

$$\frac{T}{\rho U^2 r^2} = f \left( \frac{\rho U r}{\mu} \right) g \left( \frac{r N}{U} \right) \quad (9.V.g)$$

where  $f$  and  $g$  are arbitrary functions to be determined in experiments. Note the  $rpm$  or  $N$  refers to the rotation in radian per second even though  $rpm$  refers to revolution per minute.

It has to be mentioned that these experiments have to be constructed in such way that the initial conditions and the boundary conditions are somehow "eliminated." In practical purposes the thrust is a function of Reynolds number and several other parameters. In this example, a limited information is provided on which only Reynolds number with an additional dimensionless parameter is mentioned above.

---

End Solution

---

#### Example 9.6:

*The surface wave is a small disturbance propagating in a liquid surface. Assume that this speed for a certain geometry is a function of the surface tension,  $\sigma$ , density,  $\rho$ , and the wave length of the disturbance (or frequency of the disturbance). The flow-in to the chamber or the opening of gate is creating a disturbance. The knowledge when this disturbance is important and is detected by with the time it traveled. The time control of this certain process is critical because the chemical kinetics. The calibration of the process was done with satisfactory results. Technician by mistake releases a chemical which reduces the surface tension by half. Estimate the new speed of the disturbance.*

#### SOLUTION

In the problem the functional analysis was defined as

$$U = f(\sigma, \rho, \lambda) \quad (9.VI.a)$$

Equation (9.VI.a) leads to three equations as

$$\underbrace{\frac{U}{L}}_t = \left( \underbrace{\frac{\rho}{M}}_{L^2} \right)^a \left( \underbrace{\frac{\sigma}{M}}_{t^2} \right)^b \left( \underbrace{\frac{\lambda}{L}}_L \right)^c \quad (9.VI.b)$$

$$\begin{aligned} \text{Mass, } M & \quad a + b = 0 \\ \text{Length, } L & \quad -2a + c = 1 \\ \text{time, } t & \quad -2b = -1 \end{aligned} \quad (9.VI.c)$$

The solution of equation set (9.VI.c) results in

$$U = \sqrt{\frac{\sigma}{\lambda \rho}} \quad (9.VI.d)$$

Hence reduction of the surface tension by half will reduce the disturbance velocity by  $1/\sqrt{2}$ .

---

End Solution

---

#### Example 9.7:

*Eckert number represent the amount of dissipation. Alternative number represents the dissipation, could be constructed as*

$$D_{iss} = \frac{\mu \left( \frac{dU}{dl} \right)^2}{\rho U^2} = \frac{\mu \left( \frac{dU}{dl} \right)^2 \ell}{\rho U^3} \quad (9.VII.a)$$

*Show that this number is dimensionless. What is the physical interpretation it could have? Flow is achieved steady state for a very long two dimensional channel where the upper surface is moving at speed,  $U_{up}$ , and lower is fix. The flow is pure Couette flow i.e. a linear velocity. Developed an expression for dissipation number using the information provided.*

#### SOLUTION

The nominator and denominator have to have the same units.

$$\begin{aligned} \frac{\underbrace{\mu}_{M}}{\underbrace{L}t} \frac{\underbrace{\left( \frac{dU}{dl} \right)^2}_{L^2}}{t^2 \underbrace{L^2}} \underbrace{\ell}_{L} &= \frac{\underbrace{\rho}_{M}}{\underbrace{L^3}} \frac{\underbrace{U^3}_{L^3}}{t^3} \\ \rightsquigarrow \frac{M}{t^3} &= \frac{M}{t^3} \end{aligned} \quad (9.VII.b)$$

The averaged velocity could be represented (there are better methods or choices) of the energy flowing in the channel. The averaged velocity is  $U/2$  and the velocity derivative is  $dU/d\ell = \text{constant} = U/\ell$ . With these value of the Diss number is

$$Diss = \frac{\mu \left(\frac{U}{\ell}\right)^2 \ell}{\rho \frac{U^3}{8}} = \frac{4\mu}{\rho \ell U} \quad (9.VII.c)$$

The results show that Dissipation number is not a function of the velocity. Yet, the energy lost is a function of the velocity square  $E \propto Diss \mu U$ .

---

End Solution

---

### 9.2.3.2 Building Blocks Method: Constructing Dimensional Parameters

Note, as opposed to the previous method, this technique allows one to find a single or several dimensionless parameters without going for the whole calculations of the dimensionless parameters.

Example 9.8:

Assume that the parameters that effects the centrifugal pumps are

$Q$	Pump Flow rate	$\text{rpm or } N$	angular rotation speed
$D$	rotor diameter	$\rho$	liquid density (assuming liquid phase)
$B_T$	Liquid Bulk modulus	$\mu$	liquid viscosity
$\epsilon$	typical roughness of pump surface	$g$	gravity force (body force)
$\Delta P$	Pressure created by the pump		

Construct the functional relationship between the variables. Discuss the physical meaning of these numbers. Discuss which of these dimensionless parameters can be neglected as it is known reasonably.

#### SOLUTION

The functionality can be written as

$$0 = f(D, N, \rho, Q, B_T, \mu, \epsilon, g, \Delta P) \quad (9.VIII.a)$$

The three basic parameters to be used are  $D$  [L],  $\rho$  [M], and  $N$  [t]. There are nine (9) parameters thus the number of dimensionless parameters is  $9 - 3 = 6$ . For simplicity



the *RPM* will be denoted as  $N$ . The first set is to be worked on is  $Q, D, \rho, N$  as

$$\underbrace{\frac{Q}{L^3}}_t = \left( \underbrace{\frac{D}{L}} \right)^a \left( \underbrace{\frac{\rho}{M}}_{L^3} \right)^b \left( \underbrace{\frac{N}{1}}_t \right)^c \quad (9.VIII.b)$$

$$\left. \begin{array}{l} \text{Length, } L \quad a - 3b = 3 \\ \text{Mass, } M \quad b = 0 \\ \text{time, } t \quad -c = -1 \end{array} \right\} \Rightarrow \pi_1 = \frac{Q}{N D^3} \quad (9.VIII.c)$$

For the second term  $B_T$  it follows

$$\underbrace{\frac{B_T}{M}}_{L t^2} = \left( \underbrace{\frac{D}{L}} \right)^a \left( \underbrace{\frac{\rho}{M}}_{L^3} \right)^b \left( \underbrace{\frac{N}{1}}_t \right)^c \quad (9.VIII.d)$$

$$\left. \begin{array}{l} \text{Mass, } M \quad b = 1 \\ \text{Length, } L \quad a - 3b = -1 \\ \text{time, } t \quad -c = -2 \end{array} \right\} \Rightarrow \pi_2 = \frac{B_T}{\rho N^2 D^2} \quad (9.VIII.e)$$

The next term,  $\mu$ ,

$$\underbrace{\frac{\mu}{M}}_{L t} = \left( \underbrace{\frac{D}{L}} \right)^a \left( \underbrace{\frac{\rho}{M}}_{L^3} \right)^b \left( \underbrace{\frac{N}{1}}_t \right)^c \quad (9.VIII.f)$$

$$\left. \begin{array}{l} \text{Mass, } M \quad b = 1 \\ \text{Length, } L \quad a - 3b = -1 \\ \text{time, } t \quad -c = -1 \end{array} \right\} \Rightarrow \pi_3 = \frac{\rho N^2 D^2}{\mu} \quad (9.VIII.g)$$

The next term,  $\epsilon$ ,

$$\underbrace{\frac{\epsilon}{L}} = \left( \underbrace{\frac{D}{L}} \right)^a \left( \underbrace{\frac{\rho}{M}}_{L^3} \right)^b \left( \underbrace{\frac{N}{1}}_t \right)^c \quad (9.VIII.h)$$

$$\left. \begin{array}{l} \text{Mass, } M \quad b = 0 \\ \text{Length, } L \quad a - 3b = 1 \\ \text{time, } t \quad -c = 0 \end{array} \right\} \Rightarrow \pi_4 = \frac{\epsilon}{D} \quad (9.VIII.i)$$

The next term,  $g$ ,

$$\underbrace{\frac{g}{L}}_{t^2} = \left( \underbrace{\frac{D}{L}} \right)^a \left( \underbrace{\frac{\rho}{M}}_{L^3} \right)^b \left( \underbrace{\frac{N}{1}}_t \right)^c \quad (9.VIII.j)$$

$$\left. \begin{array}{l} \text{Mass, } M \quad b = 0 \\ \text{Length, } L \quad a - 3b = 1 \\ \text{time, } t \quad -c = -2 \end{array} \right\} \Rightarrow \pi_5 = \frac{g}{DN^2} \quad (9.VIII.k)$$

The next term,  $\Delta P$ , (similar to  $B_T$ )

$$\underbrace{\frac{\Delta P}{L}}_{t^2} = \left( \underbrace{\frac{D}{L}} \right)^a \left( \underbrace{\frac{\rho}{M}}_{L^3} \right)^b \left( \underbrace{\frac{N}{1}}_t \right)^c \quad (9.VIII.l)$$

$$\left. \begin{array}{l} \text{Mass, } M \quad b = 1 \\ \text{Length, } L \quad a - 3b = -1 \\ \text{time, } t \quad -c = -2 \end{array} \right\} \Rightarrow \pi_6 = \frac{\Delta P}{\rho N^2 D^2} \quad (9.VIII.m)$$

The first dimensionless parameter  $\pi_1$  represents the dimensionless flow rate. The second number represents the importance of the compressibility of the liquid in the pump. Some argue that this parameter is similar to Mach number (speed of disturbance to speed of sound). The third parameter is similar to Reynolds number since the combination  $ND$  can be interpreted as velocity. The fourth number represents the production quality (mostly made by some casting process<sup>7</sup>). The fifth dimensionless parameter is related to the ratio of the body forces to gravity forces. The last number represent the “effectiveness” of pump or can be viewed as dimensionless pressure obtained from the pump.

In practice, the roughness is similar to similar size pump and can be neglected. However, if completely different size of pumps are compared then this number must be considered. In cases where the compressibility of the liquid can be neglected or the pressure increase is relatively insignificant, the second dimensionless parameter can be neglected.

A pump is a device that intends to increase the pressure. The increase of the pressure involves energy inserted to to system. This energy is divided to a useful energy ( pressure increase) and to overcome the losses in the system. These losses has several components which includes the friction in the system, change order of the flow and “ideal flow” loss. The most dominate loss in pump is loss of order, also know as turbulence (not covered yet this book.). If this physical phenomenon is accepted

<sup>7</sup>The modern production is made by die casting process. The reader is referred to “Fundamentals of die casting design,” Genick Bar–Meir, Potto Project, 1999 to learn more.

than the resistance is neglected and the fourth parameter is removed. In that case the functional relationship can be written as

$$\frac{\Delta P}{N^2, D^2} = f\left(\frac{Q}{N D^3}\right) \quad (9.VIII.n)$$

---

End Solution

---

### 9.2.3.3 Mathematical Method: Constructing Dimensional Parameters

*Advance material can be skipped*

under construction please ignore for time being

In the progression of the development of the technique the new evolution is the mathematical method. It can be noticed that in the previous technique the same matrix was constructed with different vector solution (the right hand side of the equation). This fact is the source to improve the previous method. However, it has to be cautioned that this technique is overkill in most cases. Actually, this author is not aware for any case this technique has any advantage over the “building block” technique.

In the following hypothetical example demonstrates the reason for the reduction of variables. Assume that water is used to transport uniform grains of gold. The total amount grains of gold is to be determined per unit length. For this analysis it is assumed that grains of gold grains are uniformly distributed. The following parameters and their dimensions are considered:

*Table -9.5. Units and Parameters of gold grains*

Parameters	Units	Dimension	Remarks
grains amount	q	$M/L$	total grains per unit length
cross section area	A	$L^2$	pipe cross section
grains per volume	gr	$grains/L^3$	count of grain per V
grain weight	e	$M/grain$	count of grain per V

Notice that *grains* and *grain* are the same units for this discussion. Accordingly, the dimensional matrix can be constructed as

Table -9.6. gold grain dimensional matrix

	<b>q</b>	<b>A</b>	<b>gr</b>	<b>e</b>
M	1	0	0	1
L	1	2	3	0
grain	0	0	1	-1

In this case the total number variables are 4 and number basic units are 3. Thus, the total of one dimensional parameter.

End ignore section

— — — — — *End Advance material* — — — — —

### 9.2.4 Similarity and Similitude

One of dimensional analysis is the key point is the concept that the solution can be obtained by conducting experiments on similar but not identical systems. The analysis here suggests and demonstrates<sup>8</sup> that the solution is based on several dimensionless numbers. Hence, constructing experiments of the situation where the same dimensionless parameters obtains could, in theory, yield a solution to problem at hand. Thus, knowing what are dimensionless parameters should provide the knowledge of constructing the experiments.

In this section deals with these similarities which in the literature some refer as analogy or similitude. It is hard to obtain complete similarity. Hence, there is discussion how similar the model is to the prototype. It is common to differentiate between three kinds of similarities: geometric, kinetics, and dynamic. This characterization started because historical reasons and it, some times, has merit especially when applying Buckingham's method. In Nusselt's method this differentiation is less important.

#### Geometric Similarity

One of the logical part of dimensional analysis is how the experiences should be similar to actual body they are supposed to represent. This logical conclusion is an add-on and this author is not aware of any proof to this requirement based on Buckingham's methods. Ironically, this conclusion is based on Nusselt's method which calls for the same dimensionless boundary conditions. Again, Nusselt's method, sometimes or even often, requires similarity because the requirements to the boundary conditions. Here<sup>9</sup> this postulated idea is adapted.

<sup>8</sup>This statement is too strong. It has to be recognized that the results are as good as the guessing which in most cases is poor.

<sup>9</sup>Because this book intend to help students to pass their exams, this book present what most instructors required. It well established that this over-strict requirement and under Nusselt's method it can be overcome.

Under this idea the prototype area has to be square of the actual model or

$$\frac{A_p}{A_m} = \left( \frac{\ell_{1\text{prototype}}}{\ell_{1\text{model}}} \right)^2 = \left( \frac{\ell_{2p}}{\ell_{2m}} \right)^2 \quad (9.9)$$

where  $\ell_1$  and  $\ell_2$  are the typical dimensions in two different directions and subscript  $p$  refers to the prototype and  $m$  to the model. Under the same argument the volumes change with the cubes of lengths.

In some situations, the model faces inability to match two or more dimensionless parameters. In that case, the solution is to sacrifice the geometric similarity to minimize the undesirable effects. For example, river modeling requires to distort vertical scales to eliminate the influence of surface tension or bed roughness or sedimentation.

### Kinematic Similarity

The perfect kinetics similarity is obtained when there are geometrical similarity and the motions of the fluid above the objects are the same. If this similarity is not possible, then the desire to achieve a motion "picture" which is characterized by ratios of corresponding velocities and accelerations is the same throughout the actual flow field. It is common in the literature, to discuss the situations there the model and prototype are similar but the velocities are different by a different scaling factor.

The geometrical similarity aside the shapes and counters of the object it also can requires surface roughness and erosion of surfaces of mobile surfaces or sedimentation of particles surface tensions. These impose demands require a minimum on the friction velocity. In some cases the minimum velocity can be  $U_{min} = \sqrt{\tau_w/\rho}$ . For example, there is no way achieve low Reynolds number with thin film flow.

### Dynamics Similarity

The dynamic similarity has many confusing and conflicting definitions in the literature. Here this term refers to similarity of the forces. It follows, based on Newton's second law, that this requires that similarity in the accelerations and masses between the model and prototype. It was shown that the solution is a function of several typical dimensionless parameters. One of such dimensionless parameter is the Froude number. The solution for the model and the prototype are the same, since both cases have the same Froude number. Hence it can be written that

$$\left( \frac{U^2}{g\ell} \right)_m = \left( \frac{U^2}{g\ell} \right)_p \quad (9.10)$$

It can be noticed that  $t \sim \ell/U$  thus equation (9.10) can be written as

$$\left( \frac{U}{gt} \right)_m = \left( \frac{U}{gt} \right)_p \quad (9.11)$$

and noticing that  $a \propto U/t$

$$\left( \frac{a}{g} \right)_m = \left( \frac{a}{g} \right)_p \quad (9.12)$$

and  $a \propto F/m$  and  $m = \rho \ell^3$  hence  $a = F/\rho \ell^3$ . Substituting into equation (9.12) yields

$$\left(\frac{F}{\rho \ell^3}\right)_m = \left(\frac{F}{\rho \ell^3}\right)_p \implies \frac{F_p}{F_m} = \frac{(\rho \ell^3)_p}{(\rho \ell^3)_m} \quad (9.13)$$

In this manipulation, it was shown that the ratio of the forces in the model and forces in the prototype is related to ratio of the dimensions and the density of the same systems. While in Buckingham's methods these hand waiving are not precise, the fact remains that there is a strong correlation between these forces. The above analysis was dealing with the forces related to gravity. A discussion about force related the viscous forces is similar and is presented for the completeness.

The Reynolds numbers is a common part of Navier–Stokes equations and if the solution of the prototype and for model to be same, the Reynolds numbers have to be same.

$$Re_m = Re_p \implies \left(\frac{\rho U \ell}{\mu}\right)_m = \left(\frac{\rho U \ell}{\mu}\right)_p \quad (9.14)$$

Utilizing the relationship  $U \propto \ell/t$  transforms equation (9.14) into

$$\left(\frac{\rho \ell^2}{\mu t}\right)_m = \left(\frac{\rho \ell^2}{\mu t}\right)_p \quad (9.15)$$

multiplying by the length on both side of the fraction by  $\ell U$  as

$$\left(\frac{\rho \ell^3 U}{\mu t \ell U}\right)_m = \left(\frac{\rho \ell^3 U}{\mu t \ell U}\right)_p \implies \frac{(\rho \ell^3 U/t)_m}{(\rho \ell^3 U/t)_p} = \frac{(\mu \ell U)_m}{(\mu \ell U)_p} \quad (9.16)$$

Noticing that  $U/t$  is the acceleration and  $\rho \ell$  is the mass thus the forces on the right hand side are proportional if the  $Re$  number are the same. In this analysis/discussion, it is assumed that a linear relationship exist. However, the Navier–Stokes equations are not linear and hence this assumption is excessive and this assumption can produce another source of inaccuracy.

While this explanation is a poor practice for the real world, it common to provide questions in exams and other tests on this issue. This section is provide to this purpose.

#### Example 9.9:

*The liquid height rises in a tube due to the surface tension,  $\sigma$  is  $h$ . Assume that this height is a function of the body force (gravity,  $g$ ), fluid density,  $\rho$ , radius,  $r$ , and the contact angle  $\theta$ . Using Buckingham's theorem develop the relationship of the parameters. In experimental with a diameter 0.001 [m] and surface tension of 73 milli-Newtons/meter and contact angle of  $75^\circ$  a height is 0.01 [m] was obtained. In another situation, the surface tension is 146 milli-Newtons/meter, the diameter is 0.02 [m] and the contact angle and density remain the same. Estimate the height.*

SOLUTION

It was given that the height is a function of several parameters such

$$h = f(\sigma, \rho, g, \theta, r) \quad (9.IX.a)$$

There are 6 parameters in the problem and the 3 basic parameters  $[L, M, t]$ . Thus the number of dimensionless groups is  $(6-3=3)$ . In Buckingham's methods it is either that the angle isn't considered or the angle is dimensionless group by itself. Five parameters are left to form the next two dimensionless groups.

One technique that was suggested is the possibility to use three parameters which contain the basic parameters  $[M, L, t]$  and with them form a new group with each of the left over parameters. In this case, density,  $\rho$  for  $[M]$  and  $d$  for  $[L]$  and gravity,  $g$  for time  $[t]$ . For the surface tension,  $\sigma$  it becomes

$$\left[ \frac{\rho}{M L^{-3}} \right]^a \left[ \frac{r}{L} \right]^b \left[ \frac{g}{L t^{-2}} \right]^c \left[ \frac{\sigma}{M t^{-2}} \right]^1 = M^0 L^0 t^0 \quad (9.IX.b)$$

Equation (9.IX.b) leads to three equations which are

$$\begin{aligned} \text{Mass, } M & \quad a + 1 = 0 \\ \text{Length, } L & \quad -3a + b + c = 0 \\ \text{time, } t & \quad -2c - 2 = 0 \end{aligned} \quad (9.IX.c)$$

the solution is  $a = -1$   $b = -2$   $c = -1$  Thus the dimensionless group is  $\frac{\sigma}{\rho r^2 g}$ . The third group obtained under the same procedure to be  $h/r$ .

In the second part the calculations for the estimated of height based on the new ratios. From the above analysis the functional dependency can be written as

$$\frac{h}{d} = f\left(\frac{\sigma}{\rho r^2 g}, \theta\right) \quad (9.IX.d)$$

which leads to the same angle and the same dimensional number. Hence,

$$\frac{h_1}{d_1} = \frac{h_2}{d_2} = f\left(\frac{\sigma}{\rho r^2 g}, \theta\right) \quad (9.IX.e)$$

Since the dimensionless parameters remain the same, the ratio of height and radius must be remain the same. Hence,

$$h_2 = \frac{h_1 d_2}{d_1} = \frac{0.01 \times 0.002}{0.001} = 0.002 \quad (9.IX.f)$$

### 9.3 Nusselt's Technique

The Nusselt's method is a bit more labor intensive, in that the governing equations with the boundary and initial conditions are used to determine the dimensionless parameters. In this method, the boundary conditions together with the governing equations are taken into account as opposed to Buckingham's method. A common mistake is to ignore the boundary conditions or initial conditions. The parameters that results from this process are the dimensional parameters which control the problems. An example comparing the Buckingham's method with Nusselt's method is presented.

In this method, the governing equations, initial condition and boundary conditions are normalized resulting in a creation of dimensionless parameters which govern the solution. It is recommended, when the reader is out in the real world to simply abandon Buckingham's method all together. This point can be illustrated by example of flow over inclined plane. For comparison reasons Buckingham's method presented and later the results are compared with the results from Nusselt's method.

Example 9.10:

*Utilize the Buckingham's method to analyze a two dimensional flow in incline plane. Assume that the flow infinitely long and thus flow can be analyzed per width which is a function of several parameters. The potential parameters are the angle of inclination,  $\theta$ , liquid viscosity,  $\nu$ , gravity,  $g$ , the height of the liquid,  $h$ , the density,  $\rho$ , and liquid velocity,  $U$ . Assume that the flow is not affected by the surface tension (liquid),  $\sigma$ . You furthermore are to assume that the flow is stable. Develop the relationship between the flow to the other parameters.*

#### SOLUTION

Under the assumptions in the example presentation leads to following

$$\dot{m} = f(\theta, \nu, g, \rho, U) \quad (9.17)$$

The number of basic units is three while the number of the parameters is six thus the difference is  $6 - 3 = 3$ . Those groups (or the work on the groups creation) further can be reduced the because angle  $\theta$  is dimensionless. The units of parameters can be obtained in Table 9.3 and summarized in the following table.

Table -9.7. Units of the Pendulum Parameters

Parameter	Units	Parameter	Units	Parameter	Units
$\nu$	$L^2t^{-1}$	$g$	$L^1t^{-2}$	$U$	$L^1t^{-1}$
$\dot{m}$	$Mt^{-1}L^{-1}$	$\theta$	none	$\rho$	$ML^3$



The basic units are chosen as for the time,  $U$ , for the mass,  $\rho$ , and for the length  $g$ . Utilizing the building blocks technique provides

$$\underbrace{\frac{\dot{m}}{tL}} = \left( \underbrace{\frac{\rho}{L^3}} \right)^a \left( \underbrace{\frac{g}{t^2}} \right)^b \left( \underbrace{\frac{U}{L}} \right)^c \quad (9.X.a)$$

The equations obtained from equation (9.X.a) are

$$\left. \begin{array}{l} \text{Mass, } M \quad \quad \quad a = 1 \\ \text{Length, } L \quad -3a + b + c = -1 \\ \text{time, } t \quad \quad \quad -2b - c = -1 \end{array} \right\} \Rightarrow \pi_1 = \frac{\dot{m}g}{\rho U^3} \quad (9.X.b)$$

$$\underbrace{\frac{\nu}{L^2}} = \left( \underbrace{\frac{\rho}{L^3}} \right)^a \left( \underbrace{\frac{g}{t^2}} \right)^b \left( \underbrace{\frac{U}{L}} \right)^c \quad (9.X.c)$$

The equations obtained from equation (9.X.a) are

$$\left. \begin{array}{l} \text{Mass, } M \quad \quad \quad a = 0 \\ \text{Length, } L \quad -3a + b + c = 2 \\ \text{time, } t \quad \quad \quad -2b - c = -1 \end{array} \right\} \Rightarrow \pi_2 = \frac{\nu g}{U^3} \quad (9.X.d)$$

Thus governing equation and adding the angle can be written as

$$0 = f \left( \frac{\dot{m}g}{\rho U^3}, \frac{\nu g}{U^3}, \theta \right) \quad (9.X.e)$$

The conclusion from this analysis are that the number of controlling parameters totaled in three and that the initial conditions and boundaries are irrelevant.

---

End Solution

A small note, it is well established that the combination of angle gravity or effective body force is significant to the results. Hence, this analysis misses, at the very least, the issue of the combination of the angle gravity. Nusselt's analysis requires that the governing equations along with the boundary and initial conditions to be written. While the analytical solution for this situation exist, the parameters that effect the problem are the focus of this discussion.

In Chapter 8, the Navier–Stokes equations were developed. These equations along with the energy, mass or the chemical species of the system, and second laws governed almost all cases in thermo–fluid mechanics. This author is not aware of a compelling

reason that this fact<sup>10</sup> should be used in this chapter. The two dimensional NS equation can be obtained from equation (8.IX.a) as

$$\rho \left( \frac{\partial U_x}{\partial t} + U_x \frac{\partial U_x}{\partial x} + U_y \frac{\partial U_x}{\partial y} + U_z \frac{\partial U_x}{\partial z} \right) = -\frac{\partial P}{\partial x} + \mu \left( \frac{\partial^2 U_x}{\partial x^2} + \frac{\partial^2 U_x}{\partial y^2} + \frac{\partial^2 U_x}{\partial z^2} \right) + \rho g \sin \theta \quad (9.18)$$

and

$$\rho \left( \frac{\partial U_y}{\partial t} + U_x \frac{\partial U_y}{\partial x} + U_y \frac{\partial U_y}{\partial y} + U_z \frac{\partial U_y}{\partial z} \right) = -\frac{\partial P}{\partial y} + \mu \left( \frac{\partial^2 U_y}{\partial x^2} + \frac{\partial^2 U_y}{\partial y^2} + \frac{\partial^2 U_y}{\partial z^2} \right) + \rho g \sin \theta \quad (9.19)$$

With boundary conditions

$$\begin{aligned} U_x(y=0) &= U_0 x f(x) \\ \frac{\partial U_x}{\partial x}(y=h) &= \tau_0 f(x) \end{aligned} \quad (9.20)$$

The value  $U_0 x$  and  $\tau_0$  are the characteristic and maximum values of the velocity or the shear stress, respectively. and the initial condition of

$$U_x(x=0) = U_{0y} f(y) \quad (9.21)$$

where  $U_{0y}$  is characteristic initial velocity.

These sets of equations (9.18)–(9.21) need to be converted to dimensionless equations. It can be noticed that the boundary and initial conditions are provided in a special form where the representative velocity multiply a function. Any function can be presented by this form.

In the process of transforming the equations into a dimensionless form associated with some intelligent guess work. However, no assumption is made or required about whether or not the velocity, in the  $y$  direction. The only exception is that the  $y$  component of the velocity vanished on the boundary. No assumption is required about the acceleration or the pressure gradient etc.

The boundary conditions have typical velocities which can be used. The velocity is selected according to the situation or the needed velocity. For example, if the effect of the initial condition is under investigation than the characteristic of that velocity should be used. Otherwise the velocity at the bottom should be used. In that case, the

<sup>10</sup>In economics and several other areas, there are no governing equations established for the field nor there is necessarily concept of conservation of something. However, writing the governing equations will yield dimensionless parameters as good as the initial guess.

boundary conditions are

$$\begin{aligned}\frac{U_x(y=0)}{U_{0x}} &= f(x) \\ \mu \frac{\partial U_x}{\partial x}(y=h) &= \tau_0 g(x)\end{aligned}\tag{9.22}$$

Now it is very convenient to define several new variables:

$$\bar{U} = \frac{U_x(\bar{x})}{U_{0x}}\tag{9.23}$$

where :

$$\bar{x} = \frac{x}{h} \quad \bar{y} = \frac{y}{h}$$

The length  $h$  is chosen as the characteristic length since no other length is provided. It can be noticed that because the units consistency, the characteristic length can be used for "normalization" (see Example 9.11). Using these definitions the boundary and initial conditions becomes

$$\begin{aligned}\frac{\bar{U}_x(\bar{y}=0)}{U_{0x}} &= f'(\bar{x}) \\ \frac{h \mu}{U_{0x}} \frac{\partial \bar{U}_x}{\partial \bar{x}}(\bar{y}=1) &= \tau_0 g'(\bar{x})\end{aligned}\tag{9.24}$$

It commonly suggested to arrange the second part of equation (9.24) as

$$\frac{\partial \bar{U}_x}{\partial \bar{x}}(\bar{y}=1) = \frac{\tau_0 U_{0x}}{h \mu} g'(\bar{x})\tag{9.25}$$

Where new dimensionless parameter, the shear stress number is defined as

$$\bar{\tau}_0 = \frac{\tau_0 U_{0x}}{h \mu}\tag{9.26}$$

With the new definition equation (9.25) transformed into

$$\frac{\partial \bar{U}_x}{\partial \bar{x}}(\bar{y}=1) = \bar{\tau}_0 g'(\bar{x})\tag{9.27}$$

**Example 9.11:**

*Non-dimensionalize the following boundary condition. What are the units of the coefficient in front of the variables,  $x$ . What are relationship of the typical velocity,  $U_0$  to  $U_{max}$ ?*

$$U_x(y=h) = U_0 (a x^2 + b \exp(x))\tag{9.XI.a}$$

SOLUTION

The coefficients  $a$  and  $b$  multiply different terms and therefore must have different units. The results must be unitless thus  $a$

$$L^0 = a \overbrace{L^2}^{x^2} \implies a = \left[ \frac{1}{L^2} \right] \quad (9.XI.b)$$

From equation (9.XI.b) it clear the conversion of the first term is  $U_x = ah^2\bar{x}$ . The exponent appears a bit more complicated as

$$L^0 = b \exp\left(h \frac{x}{h}\right) = b \exp(h) \exp\left(\frac{x}{h}\right) = b \exp(h) \exp(\bar{x}) \quad (9.XI.c)$$

Hence defining

$$\bar{b} = \frac{1}{\exp h} \quad (9.XI.d)$$

With the new coefficients for both terms and noticing that  $y = h \implies \bar{y} = 1$  now can be written as

$$\frac{U_x(\bar{y} = 1)}{U_0} = \overbrace{ah^2}^{\bar{a}} x^2 + \overbrace{b \exp(h)}^{\bar{b}} \exp(\bar{x}) = \bar{a} \bar{x}^2 + \bar{b} \exp \bar{x} \quad (9.XI.e)$$

Where  $\bar{a}$  and  $\bar{b}$  are the transformed coefficients in the dimensionless presentation.

---

End Solution

After the boundary conditions the initial condition can undergo the non-dimensional process. The initial condition (9.21) utilizing the previous definitions transformed into

$$\frac{U_x(\bar{x} = 0)}{U_{0x}} = \frac{U_{0y}}{U_{0x}} f(\bar{y}) \quad (9.28)$$

Notice the new dimensionless group of the velocity ratio as results of the boundary condition. This dimensionless number was and cannot be obtained using the Buckingham's technique. The physical significance of this number is an indication to the "penetration" of the initial (condition) velocity.

The main part of the analysis if conversion of the governing equation into a dimensionless form uses previous definition with additional definitions. The dimensionless time is defined as  $\bar{t} = tU_{0x}/h$ . This definition based on the characteristic time of  $h/U_{0x}$ . Thus, the derivative with respect to time is

$$\frac{\partial U_x}{\partial t} = \frac{\partial \overbrace{U_x}^{\frac{U_x}{U_{0x}}}}{\partial \underbrace{\bar{t}}_{\frac{t U_{0x}}{h}}} U_{0x} = \frac{U_{0x}^2}{h} \frac{\partial \bar{U}_x}{\partial \bar{t}} \quad (9.29)$$

Notice that the coefficient has units of acceleration. The second term

$$U_x \frac{\partial U_x}{\partial x} = \overbrace{\frac{U_x}{U_{0x}}} \overbrace{U_{0x}} \frac{\partial}{\partial \underbrace{\frac{x}{h}}} \overbrace{\frac{U_x}{U_{0x}}} \overbrace{U_{0x}} = \frac{U_{0x}^2}{h} \overline{U_x} \frac{\partial \overline{U_x}}{\partial \overline{x}} \quad (9.30)$$

The pressure is normalized by the same initial pressure or the static pressure as  $(P - P_\infty) / (P_0 - P_\infty)$  and hence

$$\frac{\partial P}{\partial x} = \frac{\partial}{\partial \overline{x} h} \overbrace{\frac{P - P_\infty}{P_0 - P_\infty}} \overbrace{(P_0 - P_\infty)} = \frac{(P_0 - P_\infty)}{h} \frac{\partial \overline{P}}{\partial \overline{x}} \quad (9.31)$$

The second derivative of velocity looks like

$$\frac{\partial^2 U_x}{\partial x^2} = \frac{\partial}{\partial (\overline{x} h)} \frac{\partial (\overline{U_x} U_{0x})}{\partial (\overline{x} h)} = \frac{U_{0x}}{h^2} \frac{\partial^2 \overline{U_x}}{\partial \overline{x}^2} \quad (9.32)$$

The last term is the gravity  $g$  which is left for the later stage. Substituting all terms and dividing by density,  $\rho$  result in

$$\begin{aligned} \frac{U_{0x}^2}{h} \left( \frac{\partial \overline{U_x}}{\partial \overline{t}} + \overline{U_x} \frac{\partial \overline{U_x}}{\partial \overline{x}} + \overline{U_y} \frac{\partial \overline{U_x}}{\partial \overline{y}} + \overline{U_z} \frac{\partial \overline{U_x}}{\partial \overline{z}} \right) = \\ - \frac{P_0 - P_\infty}{h \rho} \frac{\partial \overline{P}}{\partial \overline{x}} + \frac{U_{0x} \mu}{h^2 \rho} \left( \frac{\partial^2 U_x}{\partial x^2} + \frac{\partial^2 U_x}{\partial y^2} + \frac{\partial^2 U_x}{\partial z^2} \right) + \frac{\rho g}{\rho} \sin \theta \end{aligned} \quad (9.33)$$

Dividing equation (9.33) by  $U_{0x}^2/h$  yields

$$\begin{aligned} \left( \frac{\partial \overline{U_x}}{\partial \overline{t}} + \overline{U_x} \frac{\partial \overline{U_x}}{\partial \overline{x}} + \overline{U_y} \frac{\partial \overline{U_x}}{\partial \overline{y}} + \overline{U_z} \frac{\partial \overline{U_x}}{\partial \overline{z}} \right) = \\ - \frac{P_0 - P_\infty}{U_{0x}^2 \rho} \frac{\partial \overline{P}}{\partial \overline{x}} + \frac{\mu}{U_{0x} h \rho} \left( \frac{\partial^2 U_x}{\partial x^2} + \frac{\partial^2 U_x}{\partial y^2} + \frac{\partial^2 U_x}{\partial z^2} \right) + \frac{g h}{U_{0x}^2} \sin \theta \end{aligned} \quad (9.34)$$

Defining "initial" dimensionless parameters as

$$Re = \frac{U_{0x} h \rho}{\mu} \quad Fr = \frac{U_{0x}}{\sqrt{g h}} \quad Eu = \frac{P_0 - P_\infty}{U_{0x}^2 \rho} \quad (9.35)$$

Substituting definition of equation (9.35) into equation (9.36) yields

$$\begin{aligned} \left( \frac{\partial \overline{U_x}}{\partial \overline{t}} + \overline{U_x} \frac{\partial \overline{U_x}}{\partial \overline{x}} + \overline{U_y} \frac{\partial \overline{U_x}}{\partial \overline{y}} + \overline{U_z} \frac{\partial \overline{U_x}}{\partial \overline{z}} \right) = \\ - Eu \frac{\partial \overline{P}}{\partial \overline{x}} + \frac{1}{Re} \left( \frac{\partial^2 U_x}{\partial x^2} + \frac{\partial^2 U_x}{\partial y^2} + \frac{\partial^2 U_x}{\partial z^2} \right) + \frac{1}{Fr^2} \sin \theta \end{aligned} \quad (9.36)$$

Equation (9.36) show one common possibility of a dimensionless presentation of governing equation. The significance of the large and small value of the dimensionless parameters will be discuss later in the book. Without actually solving the problem, Nusselt's method provides several more parameters that were not obtained by the block method. The solution of the governing equation is a function of all the parameters present in that equation and boundaries condition as well the initial condition. Thus, the solution is

$$U_x = f\left(\bar{x}, \bar{y}, Eu, Re, Fr, \theta, \bar{\tau}_0, f_u, f_\tau, \frac{U_{0y}}{U_{0x}}\right) \quad (9.37)$$

The values of  $\bar{x}$ ,  $\bar{y}$  depend on  $h$  and hence the value of  $h$  is an important parameter.

It can be noticed with Buckingham's method, the number of parameters obtained was only three (3) while Nusselt's method yields 12 dimensionless parameters. This is a very significant difference between the two methods. In fact, there are numerous examples in the literature that showing people doing experiments based on Buckingham's methods. In these experiments, major parameters are ignored rendering these experiments useless in many cases and deceiving.

### Common Transformations

Fluid mechanics in particular and Thermo–Fluid field in general have several common transformations that appear in boundary conditions, initial conditions and equations<sup>11</sup>. It recognized that not all the possibilities can presented in the example shown above. Several common boundary conditions which were not discussed in the above example are presented below. As an initial matter, the results of the non dimensional transformation depends on the selection of what and how is nondimensionalization carried. This section of these parameters depends on what is investigated. Thus, one of the general nondimensionalization of the Navier–Stokes and energy equations will be discussed at end of this chapter.

Boundary conditions are divided into several categories such as a given value to the function<sup>12</sup>, given derivative (Neumann b.c.), mixed condition, and complex conditions. The first and second categories were discussed to some degree earlier and will be expanded later. The third and fourth categories were not discussed previously. The non–dimensionalization of the boundary conditions of the first category requires finding and diving the boundary conditions by a typical or a characteristic value. The second category involves the nondimensionalization of the derivative. In general, this process involve dividing the function by a typical value and the same for length variable (e.g.  $x$ ) as

$$\frac{\partial U}{\partial x} = \frac{\ell}{U_0} \frac{\partial \left(\frac{U}{U_0}\right)}{\partial \left(\frac{x}{\ell}\right)} = \frac{\ell}{U_0} \frac{\partial \bar{U}}{\partial \bar{x}} \quad (9.38)$$

<sup>11</sup>Many of these tricks spread in many places and fields. This author is not aware of a collection of this kind of transforms.

<sup>12</sup>The mathematicians like to call Dirichlet conditions

In the Thermo-Fluid field and others, the governing equation can be of higher order than second order<sup>13</sup>. It can be noticed that the degree of the derivative boundary condition cannot exceed the derivative degree of the governing equation (e.g. second order equation has at most the second order differential boundary condition.). In general "nth" order differential equation leads to

$$\frac{\partial^n U}{\partial x^n} = \frac{U_0}{\ell^n} \frac{\partial^n \left( \frac{U}{U_0} \right)}{\partial \left( \frac{x}{\ell} \right)^n} = \frac{U_0}{\ell^n} \frac{\partial^n \bar{U}}{\partial \bar{x}^n} \quad (9.39)$$

The third kind of boundary condition is the mix condition. This category includes combination of the function with its derivative. For example a typical heat balance at liquid solid interface reads

$$h(T_0 - T) = -k \frac{\partial T}{\partial x} \quad (9.40)$$

This kind of boundary condition, since derivative of constant is zero, translated to

$$h \cancel{(T_0 - T_{max})} \left( \frac{T_0 - T}{T_0 - T_{max}} \right) = - \frac{k \cancel{(T_0 - T_{max})}}{\ell} \frac{-\partial \left( \frac{T - T_0}{T_0 - T_{max}} \right)}{\partial \left( \frac{x}{\ell} \right)} \quad (9.41)$$

or

$$\left( \frac{T_0 - T}{T_0 - T_{max}} \right) = \frac{k}{h \ell} \frac{\partial \left( \frac{T - T_0}{T_0 - T_{max}} \right)}{\partial \left( \frac{x}{\ell} \right)} \implies \Theta = \frac{1}{Nu} \frac{\partial \Theta}{\partial \bar{x}} \quad (9.42)$$

Where Nusselt Number and the dimensionless temperature are defined as

$$Nu = \frac{h \ell}{k} \quad \Theta = \frac{T - T_0}{T_0 - T_{max}} \quad (9.43)$$

and  $T_{max}$  is the maximum or reference temperature of the system.

The last category is dealing with some non-linear conditions of the function with its derivative. For example,

$$\Delta P \approx \sigma \left( \frac{1}{r_1} + \frac{1}{r_2} \right) = \frac{\sigma}{r_1} \frac{r_1 + r_2}{r_2} \quad (9.44)$$

Where  $r_1$  and  $r_2$  are the typical principal radii of the free surface curvature, and,  $\sigma$ , is the surface tension between the gas (or liquid) and the other phase. The surface geometry (or the radii) is determined by several factors which include the liquid movement

<sup>13</sup>This author aware of fifth order partial differential governing equations in some cases. Thus, the highest derivative can be fifth order derivative.

instabilities etc chapters of the problem at hand. This boundary condition (9.45) can be rearranged to be

$$\frac{\Delta P r_1}{\sigma} \approx \frac{r_1 + r_2}{r_2} \implies Av \approx \frac{r_1 + r_2}{r_2} \quad (9.45)$$

Where  $Av$  is Av number . The Av number represents the geometrical characteristics combined with the material properties. The boundary condition (9.45) can be transferred into

$$\frac{\Delta P r_1}{\sigma} = Av \quad (9.46)$$

Where  $\Delta P$  is the pressure difference between the two phases (normally between the liquid and gas phase).

One of advantage of Nusselt's method is the Object–Oriented nature which allows one to add additional dimensionless parameters for addition “degree of freedom.” It is common assumption, to initially assume, that liquid is incompressible. If greater accuracy is needed than this assumption is removed. In that case, a new dimensionless parameters is introduced as the ratio of the density to a reference density as

$$\bar{\rho} = \frac{\rho}{\rho_0} \quad (9.47)$$

In case of ideal gas model with isentropic flow this assumption becomes

$$\bar{\rho} = \frac{\rho}{\rho_0} = \left( \frac{P_0}{P} \right)^{\frac{1}{n}} \quad (9.48)$$

The power  $n$  depends on the gas properties.

### Characteristics Values

Normally, the characteristics values are determined by physical values e.g. The diameter of cylinder as a typical length. There are several situations where the characteristic length, velocity, for example, are determined by the physical properties of the fluid(s). The characteristic velocity can determined from  $U_0 = \sqrt{2P_0/\rho}$ . The characteristic length can be determined from ratio of  $\ell = \Delta P/\sigma$ .

Example 9.12:

*One idea of renewable energy is to use and to utilize the high concentration of of brine water such as in the Salt Lake and the Salt Sea (in Israel). This process requires analysis the mass transfer process. The governing equation is non-linear and this example provides opportunity to study nondimensionalizing of this kind of equation. The conversion of the species yields a governing nonlinear equation<sup>14</sup> for such process is*

$$U_0 \frac{\partial C_A}{\partial x} = \frac{\partial}{\partial y} \frac{D_{AB}}{(1 - X_A)} \frac{\partial C_A}{\partial y} \quad (9.XII.a)$$



Where the concentration,  $C_A$  is defined as the molar density i.e. the number of moles per volume. The molar fraction,  $X_A$  is defined as the molar fraction of species  $A$  divide by the total amount of material (in moles). The diffusivity coefficient,  $D_{AB}$  is defined as penetration of species  $A$  into the material. What are the units of the diffusivity coefficient? The boundary conditions of this partial differential equation are given by

$$\frac{\partial C_A}{\partial y}(y = \infty) = 0 \quad (9.XII.b)$$

$$C_A(y = 0) = C_e \quad (9.XII.c)$$

Where  $C_e$  is the equilibrium concentration. The initial condition is

$$C_A(x = 0) = C_0 \quad (9.XII.d)$$

Select dimensionless parameters so that the governing equation and boundary and initial condition can be presented in a dimensionless form. There is no need to discuss the physical significance of the problem.

#### SOLUTION

This governing equation requires to work with dimension associated with mass transfer and chemical reactions, the "mole." However, the units should not cause confusion or fear since it appear on both sides of the governing equation. Hence, this unit will be canceled. Now the units are compared to make sure that diffusion coefficient is kept the units on both sides the same. From units point of view, equation (9.XII.a) can be written (when the concentration is simply ignored) as

$$\underbrace{\frac{U}{L}}_{\cancel{L}} \underbrace{\frac{\partial C}{\partial x}}_{\cancel{L}} = \underbrace{\frac{\partial}{\partial y}}_{\cancel{L}} \underbrace{\frac{D_{AB}}{(1-X)}}_{\cancel{1}} \underbrace{\frac{\partial C}{\partial y}}_{\cancel{L}} \quad (9.XII.e)$$

It can be noticed that  $X$  is unitless parameter because two same quantities are divided.

$$\frac{1}{t} = \frac{1}{L^2} D_{AB} \implies D_{AB} = \frac{L^2}{t} \quad (9.XII.f)$$

Hence the units of diffusion coefficient are typically given by  $[m^2/sec]$  (it also can be observed that based on Fick's laws of diffusion it has the same units).

The potential of possibilities of dimensionless parameter is large. Typically, dimensionless parameters are presented as ratio of two quantities. In addition to that, in heat and mass transfer (also in pressure driven flow etc.) the relative or reference to certain point has to accounted for. The boundary and initial conditions here provides

<sup>14</sup>More information how this equation was derived can be found in Bar-Meir (Meyerson), Genick "Hygroscopic absorption to falling films: The effects of the concentration level" M.S. Thesis Tel-Aviv Univ. (Israel). Dept. of Fluid Mechanics and Heat Transfer 12/1991.

the potential of the “driving force” for the mass flow or mass transfer. Hence, the potential definition is

$$\Phi = \frac{C_A - C_0}{C_e - C_0} \quad (9.XII.g)$$

With almost “standard” transformation

$$\bar{x} = \frac{x}{\ell} \quad \bar{y} = \frac{y}{\ell} \quad (9.XII.h)$$

Hence the derivative of  $\Phi$  with respect to time is

$$\frac{\partial \Phi}{\partial \bar{x}} = \frac{\partial \frac{C_A - C_0}{C_e - C_0}}{\partial \frac{x}{\ell}} = \frac{\ell}{C_e - C_0} \frac{\partial (C_A - C_0)}{\partial x} = \frac{\ell}{C_e - C_0} \frac{\partial C_A}{\partial x} \quad (9.XII.i)$$

In general a derivative with respect to  $\bar{x}$  or  $\bar{y}$  leave yields multiplication of  $\ell$ . Hence, equation (9.XII.a) transformed into

$$\begin{aligned} U_0 \frac{(\cancel{C_e - C_0})}{\ell} \frac{\partial \Phi}{\partial \bar{x}} &= \frac{1}{\ell} \frac{\partial}{\partial \bar{y}} \frac{D_{AB}}{(1 - X_A)} \frac{(\cancel{C_e - C_0})}{\ell} \frac{\partial \Phi}{\partial \bar{y}} \\ \rightsquigarrow U_0 \frac{\partial \Phi}{\partial \bar{x}} &= \frac{1}{\ell^2} \frac{\partial}{\partial \bar{y}} \frac{D_{AB}}{(1 - X_A)} \frac{\partial \Phi}{\partial \bar{y}} \end{aligned} \quad (9.XII.j)$$

Equation (9.XII.j) like non-dimensionalized and proper version. However, the term  $X_A$ , while is dimensionless, is not proper. Yet,  $X_A$  is a function of  $\Phi$  because it contains  $C_A$ . Hence, this term,  $X_A$  has to be converted or presented by  $\Phi$ . Using the definition of  $X_A$  it can be written as

$$X_A = \frac{C_A}{C} = (C_e - C_0) \frac{C_A - C_0}{C_e - C_0} \frac{1}{C} \quad (9.XII.k)$$

Thus the transformation in equation (9.XII.l) another unexpected dimensionless parameter as

$$X_A = \Phi \frac{C_e - C_0}{C} \quad (9.XII.l)$$

Thus number,  $\frac{C_e - C_0}{C}$  was not expected and it represent ratio of the driving force to the height of the concentration which was not possible to attend by Buckingham’s method.

---

End Solution

## 9.4 Summary of Dimensionless Numbers

This section summarizes all the major dimensionless parameters which are commonly used in the fluid mechanics field.

Table -9.8. Common Dimensionless Parameters of Thermo-Fluid in the Field

Name	Symbol	Equation	Interpretation	Application
<b>Archimede Number</b>	$Ar$	$\frac{g \ell^3 \rho_f (\rho - \rho_f)}{\mu^2}$	$\frac{\text{buoyancy forces}}{\text{viscous force}}$	in nature and force convection
<b>Atwood Number</b>	$A$	$\frac{(\rho_a - \rho_b)}{\rho_a + \rho_b}$	$\frac{\text{buoyancy forces}}{\text{"penetration" force}}$	in stability of liquid layer $a$ over $b$ Rayleigh Taylor instability etc.
<b>Bond Number</b>	$Bo$	$\frac{\rho g \ell^2}{\sigma}$	$\frac{\text{gravity forces}}{\text{surface tension force}}$	in open channel flow, thin film flow
<b>Brinkman Number</b>	$Br$	$\frac{\mu U^2}{k \Delta T}$	$\frac{\text{heat dissipation}}{\text{heat conduction}}$	during dissipation problems
<b>Capillary Number</b>	$Ca$	$\frac{\mu U}{\sigma}$	$\frac{\text{viscous force}}{\text{surface tension force}}$	For small $Re$ and surface tension involve problem
<b>Cauchy Number</b>	$Ca_u$	$\frac{\rho U^2}{E}$	$\frac{\text{inertia force}}{\text{elastic force}}$	For large $Re$ and surface tension involve problem
<b>Cavitation Number</b>	$\sigma$	$\frac{P_l - P_v}{\frac{1}{2} \rho U^2}$	$\frac{\text{pressure difference}}{\text{inertia energy}}$	pressure difference to vapor pressure to the potential of phase change (mostly to gas)
<b>Courant Number</b>	$Co$	$\frac{\Delta t U}{\Delta x}$	$\frac{\text{wave distance}}{\text{Typical Distance}}$	A requirement in numerical schematic to achieve stability)
<b>Dean Number</b>	$D$	$\frac{Re}{\sqrt{R/h}}$	$\frac{\text{inertia forces}}{\text{viscous deviation forces}}$	related to radius of channel with width $h$ stability
<b>Deborah Number<sup>15</sup></b>	$De$	$\frac{t_c}{t_p}$	$\frac{\text{stress relaxation time}}{\text{observation time}}$	the ratio of the fluidity of material primary used in rheology
<b>Drag Coefficient</b>	$C_D$	$\frac{D}{\frac{1}{2} \rho U^2 A}$	$\frac{\text{drag force}}{\text{inertia effects}}$	Aerodynamics, hydrodynamics, note this coefficient has many definitions
<b>Eckert Number</b>	$Ec$	$\frac{U^2}{C_p \Delta T}$	$\frac{\text{inertia effects}}{\text{thermal effects}}$	during dissipation problems

Continued on next page

Table -9.8. Common Dimensionless Parameters of Fluid Mechanics (continue)

Standard System				
Name	Symbol	Equation	Interpretation	Application
<b>Ekman Number</b>	$Ek$	$\frac{\nu}{2\ell^2 \omega}$	<u>viscous forces</u> <u>Coriolis forces</u>	geophysical flow like atmospheric flow
<b>Euler Number</b>	$Eu$	$\frac{P_0 - P_\infty}{\frac{1}{2} \rho U^2}$	<u>pressure potential effects</u> <u>inertia effects</u>	potential of resistance problems
<b>Froude Number</b>	$Fr$	$\frac{U}{\sqrt{g\ell}}$	<u>inertia effects</u> <u>gravitational effects</u>	open channel flow and two phase flow
<b>Galileo Number</b>	$Ga$	$\frac{\rho g \ell^3}{\mu^2}$	<u>gravitational effects</u> <u>viscous effects</u>	open channel flow and two phase flow
<b>Grashof Number</b>	$Gr$	$\frac{\beta \Delta T g \ell^3 \rho^2}{\mu^2}$	<u>buoyancy effects</u> <u>viscous effects</u>	natural convection
<b>Knudsen Number</b>	$Kn$	$\frac{\lambda}{\ell}$	<u>LMFP</u> <u>characteristic length</u>	length of mean free path, LMFP, to characteristic length
<b>Laplace Constant</b>	$La$	$\sqrt{\frac{2\sigma}{g(\rho_1 - \rho_2)}}$	<u>surface force</u> <u>gravity effects</u>	liquid raise, surface tension problem, also ref:Capillary constant
<b>Lift Coefficient</b>	$C_L$	$\frac{L}{\frac{1}{2} \rho U^2 A}$	<u>lift force</u> <u>inertia effects</u>	Aerodynamics, hydrodynamics, note this coefficient has many definitions
<b>Mach Number</b>	$M$	$\frac{U}{c}$	<u>velocity</u> <u>sound speed</u>	compressibility and propagation of disturbances
<b>Marangoni Number</b>	$Ma$	$\frac{d\sigma}{dT} \frac{\ell \Delta T}{\nu \alpha}$	<u>"thermal" surface tension</u> <u>viscous force</u>	surface tension caused by thermal gradient
<b>Morton Number</b>	$Mo$	$\frac{g \mu_c^4 \Delta \rho}{\rho_c^2 \sigma^3}$	<u>viscous force</u> <u>surface tension force</u>	bubble and drop flow
<b>Ozer Number</b>	$Oz$	$\frac{c_D^2 P_{max}}{\left(\frac{\rho}{Q_{max}}\right)^2}$	<u>"maximum" supply</u> <u>"maximum" demand</u>	supply and demand analysis such pump & pipe system, economy

Continued on next page

Table -9.8. Common Dimensionless Parameters of Fluid Mechanics (continue)

Standard System				
Name	Symbol	Equation	Interpretation	Application
<b>Prandtl Number</b>	$Pr$	$\frac{\nu}{\alpha}$	$\frac{\text{viscous diffusion rate}}{\text{thermal diffusion rate}}$	Prandtl is fluid property important in flow due to thermal forces
<b>Reynolds Number</b>	$Re$	$\frac{\rho U \ell}{\mu}$	$\frac{\text{inertia forces}}{\text{viscous forces}}$	In most fluid mechanics issues
<b>Rossby Number</b>	$Ro$	$\frac{U}{\omega \ell_0}$	$\frac{\text{inertia forces}}{\text{Coriolis forces}}$	In rotating fluids
<b>Shear Number</b>	$Sn$	$\frac{\tau_c \ell_c}{\mu_c U_c}$	$\frac{\text{actual shear}}{\text{"potential" shear}}$	shear flow
<b>Stokes Number</b>	$Stk$	$\frac{t_p}{t_K}$	$\frac{\text{particle relaxation time}}{\text{Kolmogorov time}}$	In aerosol flow dealing with penetration of particles
<b>Strouhal Number</b>	$St$	$\frac{\omega \ell}{U}$	$\frac{\text{"unsteady" effects}}{\text{inertia effect}}$	The effects of natural or forced frequency in all the field that is how much the "unsteadiness" of the flow is
<b>Taylor Number</b>	$Ta$	$\frac{\rho^2 \omega_i^2 \ell^4}{\mu^4}$	$\frac{\text{centrifugal forces}}{\text{viscous forces}}$	Stability of rotating cylinders Notice $\ell$ has special definition
<b>Weber Number</b>	$We$	$\frac{\rho U^2 \ell}{\sigma}$	$\frac{\text{inertia force}}{\text{surface tension force}}$	For large $Re$ and surface tension involve problem

The dimensional parameters that were used in the construction of the dimensionless parameters in Table 10.2 are the characteristics of the system. Therefore there are several definition of Reynolds number. In fact, in the study of the physical situations often people refers to local  $Re$  number and the global  $Re$  number. Keeping this point in mind, there several typical dimensions which need to be mentioned. The typical body force is the gravity  $g$  which has a direction to center of Earth. The elasticity  $E$  in case of liquid phase is  $B_T$ , in case of solid phase is Young modulus. The typical length is denoted as  $\ell$  and in many cases it is referred to as the diameter or the radius. The

<sup>15</sup>This number is named by Reiner, M. (1964), "The Deborah Number", Physics Today 17 (1): 62, doi:10.1063/1.3051374. Reiner, a civil engineer who is considered the father of Rheology, named this parameter because theological reasons perhaps since he was living in Israel.

density,  $\rho$  is referred to the characteristic density or density at infinity. The area,  $A$  in drag and lift coefficients is referred normally to projected area.

The frequency  $\omega$  or  $f$  is referred to as the “unsteadiness” of the system. Generally, the periodic effect is enforced by the boundary conditions or the initial conditions. In other situations, the physics itself instores or forces periodic instability. For example, flow around cylinder at first looks like symmetrical situation. And indeed in a low Reynolds number it is a steady state. However after a certain value of Reynolds number, vortexes are created in an infinite parade and this phenomenon is called Von Karman vortex street (see Figure 9.4) which named after Von Karman. These vortexes are created in a non-symmetrical way and hence create an unsteady situation. When Reynolds number increases, these vortexes are mixed and the flow becomes turbulent which, can be considered a steady state<sup>16</sup>.



Fig. -9.4. Oscillating Von Karman Vortex Street.

The pressure  $P$  is the pressure at infinity or when the velocity is at rest.  $c$  is the speed of sound of the fluid at rest or characteristic value. The value of the viscosity,  $\mu$  is typically some kind averaged value. The inability to define a fix value leads also to new dimensionless numbers which represent the deviations of these properties.

### 9.4.1 The Significance of these Dimensionless Numbers

Reynolds number, named in the honor of Reynolds, represents the ratio of the momentum forces to the viscous forces. Historically, this number was one of the first numbers to be introduced to fluid mechanics. This number determines, in many cases, the flow regime.

Example 9.13:

*Eckert number<sup>17</sup> determines whether the role of the momentum energy is transferred to thermal energy is significant to affect the flow. This effect is important in situations where high speed is involved. This fact suggests that Eckert number is related to Mach number. Determine this relationship and under what circumstances this relationship is true.*

SOLUTION

<sup>16</sup>This is an example where the more unsteady the situation becomes the situation can be analyzed as a steady state because averages have a significant importance.

<sup>17</sup>This example is based on Bird, Lightfoot and Stuart “Transport Phenomena”.

In Table 10.2 Mach and Eckert numbers are defined as

$$Ec = \frac{U^2}{C_p \Delta T} \quad M = \frac{U}{\sqrt{\frac{P}{\rho}}} \quad (9.XIII.a)$$

The material which obeys the ideal flow model<sup>18</sup> ( $P/\rho = RT$  and  $P = C_1 \rho^k$ ) can be written that

$$M = U \left/ \sqrt{\frac{P}{\rho}} \right. = \frac{U}{\sqrt{k RT}} \quad (9.XIII.b)$$

For the comparison, the reference temperature used to be equal to zero. Thus Eckert number can be written as

$$\sqrt{Ec} = \frac{U}{\sqrt{C_p T}} = \frac{U}{\sqrt{\left(\frac{Rk}{k-1}\right) T}} = \frac{\sqrt{k-1} U}{\sqrt{k RT}} = \sqrt{k-1} M \quad (9.XIII.c)$$

The Eckert number and Mach number are related under ideal gas model and isentropic relationship.

---

End Solution

---

Brinkman number measures of the importance of the viscous heating relative the conductive heat transfer. This number is important in cases when a large velocity change occurs over short distances such as lubricant, supersonic flow in rocket mechanics creating large heat effect in the head due to large velocity (in many place it is a combination of Eckert number with Brinkman number. The Mach number is based on different equations depending on the property of the medium in which pressure disturbance moves through. Cauchy number and Mach number are related as well and see Example 9.15 for explanation.

Example 9.14:

*For historical reason some fields prefer to use certain numbers and not other ones. For example in Mechanical engineers prefer to use the combination  $Re$  and  $We$  number while Chemical engineers prefers to use the combination of  $Re$  and the Capillary number. While in some instances this combination is justified, other cases it is arbitrary. Show what the relationship between these dimensionless numbers.*

SOLUTION

The definitions of these number in Table 10.2

$$We = \frac{\rho U^2 \ell}{\sigma} \quad Re = \frac{\rho U \ell}{\mu} \quad Ca = \frac{\mu U}{\sigma} = \frac{U}{\frac{\sigma}{\mu}} \quad (9.XIV.a)$$

---

<sup>18</sup>See for more details <http://www.potto.org/gasDynamics/node70.html>

Dividing Weber number by Reynolds number yields

$$\frac{We}{Re} = \frac{\frac{\rho U^2 \ell}{\sigma}}{\frac{\rho U \ell}{\mu}} = \frac{U}{\frac{\sigma}{\mu}} = Ca \quad (9.XIV.b)$$

---

End Solution

---

Euler number is named after Leonhard Euler (1707 1783), a German Physicist who pioneered so many fields that it is hard to say what and where are his greatest contributions. Eulers number and Cavitation number are essentially the same with the exception that these numbers represent different driving pressure differences. This difference from dimensional analysis is minimal. Furthermore, Euler number is referred to as the pressure coefficient,  $C_p$ . This confusion arises in dimensional analysis because historical reasons and the main focus area. The cavitation number is used in the study of cavitation phenomena while Euler number is mainly used in calculation of resistances.

Example 9.15:

*Explained under what conditions and what are relationship between the Mach number and Cauchy number?*

SOLUTION

Cauchy number is defined as

$$Cau = \frac{\rho U^2}{E} \quad (9.XV.a)$$

The square root of Cauchy number is

$$\sqrt{Cau} = \frac{U}{\sqrt{\frac{E}{\rho}}} \quad (9.XV.b)$$

In the liquid phase the speed of sound is approximated as

$$c = \frac{E}{\rho} \quad (9.XV.c)$$

Using equation (9.XV.b) transforms equation (9.XV.a) into

$$\sqrt{Cau} = \frac{U}{c} = M \quad (9.49)$$

Thus the square root of  $Cau$  is equal to Mach number in the liquid phase. In the solid phase equation (9.XV.c) is less accurate and speed of sound depends on the direction of the grains. However, as first approximation, this analysis can be applied also to the solid phase.

---

End Solution

---



### 9.4.2 Relationship Between Dimensionless Numbers

The Dimensionless numbers since many of them have formulated in a certain field tend to be duplicated. For example, the Bond number is referred in Europe as Eotvos number. In addition to the above confusion, many dimensional numbers expressed the same things under certain conditions. For example, Mach number and Eckert Number under certain circumstances are same.

Example 9.16:

*Galileo Number is a dimensionless number which represents the ratio of gravitational forces and viscous forces in the system as*

$$Ga = \frac{\rho^2 g \ell^3}{\mu^2} \quad (9.XVI.a)$$

*The definition of Reynolds number has viscous forces and the definition of Froude number has gravitational forces. What are the relation between these numbers?*

Example 9.17:

*Laplace Number is another dimensionless number that appears in fluid mechanics which related to Capillary number. The Laplace number definition is*

$$La = \frac{\rho \sigma \ell}{\mu^2} \quad (9.XVII.a)$$

*Show what are the relationships between Reynolds number, Weber number and Laplace number.*

Example 9.18:

*The Rotating Froude Number is a somewhat a similar number to the regular Froude number. This number is defined as*

$$Fr_R = \frac{\omega^2 \ell}{g} \quad (9.XVIII.a)$$

*What is the relationship between two Froude numbers?*

Example 9.19:

*Ohnesorge Number is another dimensionless parameter that deals with surface tension and is similar to Capillary number and it is defined as*

$$Oh = \frac{\mu}{\sqrt{\rho \sigma \ell}} \quad (9.XIX.a)$$

*Defined Oh in term of We and Re numbers.*

### 9.4.3 Examples for Dimensional Analysis

Example 9.20:

The similarity of pumps is determined by comparing several dimensional numbers among them are Reynolds number, Euler number, Rossby number etc. Assume that the only numbers which affect the flow are Reynolds and Euler number. The flow rate of the imaginary pump is  $0.25 \text{ [m}^3/\text{sec]}$  and pressure increase for this flow rate is  $2 \text{ [Bar]}$  with  $2500 \text{ [kw]}$ . Due to increase of demand, it is suggested to replace the pump with a 4 times larger pump. What is the new estimated flow rate, pressure increase, and power consumption?

SOLUTION

It provided that the Reynolds number controls the situation. The density and viscosity remains the same and hence

$$Re_m = Re_p \implies U_m D_m = U_p D_p \implies U_p = \frac{D_m}{D_p} U_m \quad (9.XX.a)$$

It can be noticed that initial situation is considered as the model and while the new pump is the prototype. The new flow rate,  $Q$ , depends on the ratio of the area and velocity as

$$\frac{Q_p}{Q_m} = \frac{A_p U_p}{A_m U_m} \implies Q_p = Q_m \frac{A_p U_p}{A_m U_m} = Q_m \frac{D_p^2 U_p}{D_m^2 U_m} \quad (9.XX.b)$$

Thus the prototype flow rate is

$$Q_p = Q_m \left( \frac{D_p}{D_m} \right)^3 = 0.25 \times 4^3 = 16 \left[ \frac{\text{m}^3}{\text{sec}} \right] \quad (9.XX.c)$$

The new pressure is obtain by comparing the Euler number as

$$Eu_p = Eu_m \implies \left( \frac{\Delta P}{\frac{1}{2} \rho U^2} \right)_p = \left( \frac{\Delta P}{\frac{1}{2} \rho U^2} \right)_m \quad (9.XX.d)$$

Rearranging equation (9.XX.d) provides

$$\frac{(\Delta P)_p}{(\Delta P)_m} = \frac{(\rho U^2)_p}{(\rho U^2)_m} = \frac{(U^2)_p}{(U^2)_m} \quad (9.XX.e)$$

Utilizing equation (9.XX.a)

$$\Delta P_p = \Delta P_m \left( \frac{D_p}{D_m} \right)^2 \quad (9.XX.f)$$

The power can be obtained from the following

$$\dot{W} = \frac{F \ell}{t} = F U = P A U \quad (9.XX.g)$$

In this analysis, it is assumed that pressure is uniform in the cross section. This assumption is appropriate because only the secondary flows in the radial direction (to be discussed in this book section on pumps.). Hence, the ratio of power between the two pump can be written as

$$\frac{\dot{W}_p}{\dot{W}_m} = \frac{(PAU)_p}{(PAU)_m} \quad (9.XX.h)$$

Utilizing equations above in this ratio leads to

$$\frac{\dot{W}_p}{\dot{W}_m} = \overbrace{\left(\frac{D_p}{D_m}\right)^2}^{P_p/P_m} \overbrace{\left(\frac{D_p}{D_m}\right)^2}^{A_p/A_m} \overbrace{\left(\frac{D_p}{D_m}\right)}^{U_p/U_m} = \left(\frac{D_p}{D_m}\right)^5 \quad (9.XX.i)$$

---

End Solution

---

#### Example 9.21:

*The flow resistance to flow of the water in a pipe is to be simulated by flow of air. Estimate the pressure loss ratio if Reynolds number remains constant. This kind of study appears in the industry in which the compressibility of the air is ignored. However, the air is a compressible substance that flows the ideal gas model. Water is a substance that can be considered incompressible flow for relatively small pressure change. Estimate the error using the averaged properties of the air.*

#### SOLUTION

For the first part, the Reynolds number is the single controlling parameter which affects the pressure loss. Thus it can be written that the Euler number is function of the Reynolds number.

$$Eu = f(Re) \quad (9.XXI.a)$$

Thus, to have a similar situation the Reynolds and Euler have to be same.

$$Re_p = Re_m \quad Eu_m = Eu_p \quad (9.XXI.b)$$

Hence,

$$\frac{U_m}{U_p} = \frac{\ell_p}{\ell_m} \frac{\rho}{\rho_m} \frac{\mu_p}{\mu_m} \quad (9.XXI.c)$$

and for Euler number

$$\frac{\Delta P_m}{\Delta P_p} = \frac{\rho_m}{\rho_p} \frac{U_m}{U_p} \quad (9.XXI.d)$$

and utilizing equation (9.XXI.c) yields

$$\frac{\Delta P_m}{\Delta P_p} = \left(\frac{\ell_p}{\ell_m}\right)^2 \left(\frac{\mu_m}{\mu_p}\right)^2 \left(\frac{\rho_p}{\rho_m}\right) \quad (9.XXI.e)$$

Inserting the numerical values results in

$$\frac{\Delta P_m}{\Delta P_p} = 1 \times 1000 \times \quad (9.XXI.f)$$

It can be noticed that the density of the air changes considerably hence the calculations produce a considerable error which can render the calculations useless (a typical problem of Buckingham's method). Assuming a new variable that effect the problem, air density variation. If that variable is introduced into problem, air can be used to simulate water flow. However as a first approximation, the air properties are calculated based on the averaged values between the entrance and exit values. If the pressure reduction is a function of pressure reduction (iterative process).

to be continue

---

End Solution

---

Example 9.22:

*A device operating on a surface of a liquid to study using a model with a ratio 1:20. What should be ratio of kinematic viscosity between the model and prototype so that Froude and Reynolds numbers remain the same. Assume that body force remains the same and velocity is reduced by half.*

SOLUTION

The requirement is that Reynolds

$$Re_m = Re_p \implies \left( \frac{U \ell}{\nu} \right)_p = \left( \frac{U \ell}{\nu} \right)_m \quad (9.XXII.a)$$

The Froude needs to be similar so

$$Fr_m = Fr_p \implies \left( \frac{U}{\sqrt{g \ell}} \right)_p = \left( \frac{U}{\sqrt{g \ell}} \right)_m \quad (9.XXII.b)$$

dividing equation (9.XXII.a) by equation (9.XXII.b) results in

$$\left( \frac{U \ell}{\nu} \right)_p / \left( \frac{U}{\sqrt{g \ell}} \right)_p = \left( \frac{U \ell}{\nu} \right)_m / \left( \frac{U}{\sqrt{g \ell}} \right)_m \quad (9.XXII.c)$$

or

$$\left( \frac{\ell \sqrt{g \ell}}{\nu} \right)_p = \left( \frac{\ell \sqrt{g \ell}}{\nu} \right)_m \quad (9.XXII.d)$$

If the body force<sup>19</sup>,  $g$ , The kinematic viscosity ratio is then

$$\frac{\nu_p}{\nu_m} = \left( \frac{\ell_m}{\ell_p} \right)^{3/2} = (1/20)^{3/2} \quad (9.XXII.e)$$

---

<sup>19</sup>The body force does not necessarily have to be the gravity.

It can be noticed that this can be achieved using Ohnesorge Number like this presentation.

---

End Solution

---

## 9.5 Summary

The two dimensional analysis methods or approaches were presented in this chapter. Buckingham's  $\pi$  technique is a quick "fix approach" which allow rough estimates and relationship between model and prototype. Nusselt's approach provides an heavy duties approach to examine what dimensionless parameters effect the problem. It can be shown that these two techniques in some situations provide almost similar solution. In other cases, these technique proves different and even conflicting results. The dimensional analysis technique provides a way to simplify models (solving the governing equation by experimental means) and to predict effecting parameters.

## 9.6 Appendix summary of Dimensionless Form of Navier–Stokes Equations

In a vector form Navier–Stokes equations can be written and later can be transformed into dimensionless form which will yield dimensionless parameters. First, the typical or characteristics values of scaling parameters has to be presented and appear in the following table

Parameter Symbol	Parameter Description	Units
$h$	characteristic length	$[L]$
$U_0$	characteristic velocity	$\left[\frac{L}{t}\right]$
$f$	characteristic frequency	$\left[\frac{1}{t}\right]$
$\rho_0$	characteristic density	$\left[\frac{M}{L^3}\right]$
$P_{max} - P_\infty$	maximum pressure drive	$\left[\frac{M}{L t^2}\right]$

Basic non–dimensional form of the parameters

$$\begin{aligned}
 \tilde{t} &= ft & \tilde{\mathbf{r}} &= \frac{\mathbf{r}}{h} & \tilde{\mathbf{U}} &= \frac{\mathbf{U}}{U_0} \\
 \tilde{\mathbf{P}} &= \frac{\mathbf{P} - P_\infty}{P_{max} - P_\infty} & \tilde{\nabla} &= h \nabla & \tilde{\rho} &= \frac{\rho}{\rho_0}
 \end{aligned} \tag{9.50}$$

For the Continuity Equation (8.17) for non-compressible substance can be transformed into

$$\frac{\partial \rho}{\partial t} + \nabla \cdot (\rho \mathbf{U}) = 0 \quad (9.51)$$

For the N-S equation, every additive term has primary dimensions  $m^1 L^{-2} t^{-2}$ . To non dimensionalization, we multiply every term by  $L/(V^2)$ , which has primary dimensions  $m^{-1} L^2 t^2$ , so that the dimensions cancel.

Using these definitions equation (8.111) results in

$$\frac{f h}{U_0} \frac{\partial \tilde{\mathbf{U}}}{\partial \tilde{t}} + (\tilde{\mathbf{U}} \cdot \tilde{\nabla}) \tilde{\mathbf{U}} = - \left( \frac{P_{max} - P_{\infty}}{\rho \tilde{\mathbf{U}}^2} \right) \tilde{\nabla} \tilde{P} + \frac{1}{\tilde{\mathbf{U}}^2} \tilde{f}_g + \frac{1}{\rho \tilde{\mathbf{U}} h} \tilde{\nabla}^2 \tilde{\mathbf{U}} \quad (9.52)$$

Or after using the definition of the dimensionless parameters as

$$St \frac{\partial \tilde{\mathbf{U}}}{\partial \tilde{t}} + (\tilde{\mathbf{U}} \cdot \tilde{\nabla}) \tilde{\mathbf{U}} = -Eu \tilde{\nabla} \tilde{P} + \frac{1}{Fr^2} \tilde{f}_g + \frac{1}{Re} \tilde{\nabla}^2 \tilde{\mathbf{U}} \quad (9.53)$$

The definition of Froude number is not consistent in the literature. In some places  $Fr$  is defined as the square of  $Fr = U^2/g h$ .

The Strouhal number is named after Vincenz Strouhal (1850 1922), who used this parameter in his study of "singing wires." This parameter is important in unsteady, oscillating flow problems in which the frequency of the oscillation is important.

Example 9.23:

A device is accelerated linearly by a constant value  $\mathbf{B}$ . Write a new N-S and continuity equations for incompressible substance in the a coordinate system attached to the body. Using these equations developed new dimensionless equations so the new "Froude number" will contain or "swallow" by the new acceleration. Measurement has shown that the acceleration to be constant with small sinusoidal on top the constant such away as

$$\mathbf{a} = \mathbf{B} + \epsilon \sin \left( \frac{f}{2\pi} \right) \quad (9.XXIII.a)$$

Suggest a dimensionless parameter that will take this change into account.

## Supplemental Problems

1. An airplane wing of chord length 3 [m] moves through still air at 15°C and 1 [Bar] and at a speed of 15 [m/sec]. What is the air velocity for a 1:20 scale model to achieve dynamic similarity between model and prototype? Assume that in the model the air has the same pressure and temperature as that in prototype. If the air is considered as compressible, what velocity is required for pressure is 1.5[bar] and temperature 20°C? What is the required velocity of the air in the model test when the medium is made of water to keep the dynamic similarity?

9.6. APPENDIX SUMMARY OF DIMENSIONLESS FORM OF NAVIER-STOKES EQUATIONS 321

2. An airplane 100[m] long is tested by 1 [m] model. If the airplane velocity is 120 [m/s] and velocity at the wind-tunnel is 60 [m/s], calculate the model and the airplane Reynolds numbers. You can assume that both model and prototype working conditions are the same (1[Bar] and 60°C).
3. What is the pipe diameter for oil flowing at speed of 1[m/sec] to obtain dynamic similarity with a pipe for water flowing at 3 [m/sec] in a 0.02[m] pipe. State your assumptions.
4. The pressure drop for water flowing at 1 [m/sec] in a pipe was measured to be 1 [Bar]. The pipe is 0.05 [m] diameter and 100 [m] in length. What should be velocity of Castor oil to get the same Reynolds number? What would be pressure drop in that case?





---

# BIBLIOGRAPHY

- [1] Buckingham, E. On physically similar systems; illustrations of the use of dimensional equations. *Phys. Rev.* 4, 345-376 (1914).
- [2] Buckingham, E. The principle of similitude. *Nature* 96, 396-397 (1915).
- [3] Buckingham, E. Model experiments and the forms of empirical equations. *Trans. A.S.M.E.* 37, 263-296 (1915).
- [4] Görtler, H. Zur Geschichte des pi-Theorems. *ZAMM* 55, 3-8 (1975). (On the history of the pi theorem, in German.)
- [5] *Dimensional Analysis and Theory of Models* by Henry L. Langhaar (John Wiley & Sons, Inc., 1951, but also apparently Krieger Publishing Co., 1980, ).

## **A micro-biography of Edgar Buckingham**

Edgar Buckingham (1867-1940) was educated at Harvard and Leipzig, and worked at the (US) National Bureau of Standards (now the National Institute of Standards and Technology, or NIST) 1905–1937. His fields of expertise included soil physics, gas properties, acoustics, fluid mechanics, and black-body radiation.



---

---

# CHAPTER 10

---

## Inviscid Flow or Potential Flow

### *10.1 Introduction*

The mathematical complication of the Navier–Stokes equations suggests that a simplified approach can be employed. N–S equations are a second non–linear partial equations. Hence, the simplest step will be to neglect the second order terms (second derivative). From a physical point of view, the second order term represents the viscosity effects. The neglect of the second order is justified when the coefficient in front of this term, after non–dimensionalizing, is approaching zero. This coefficient in front of this term is  $1/Re$  where  $Re$  is Reynold's number. A large Reynolds number means that the coefficient is approaching zero. Reynold's number represents the ratio of inertia forces to viscous forces. There are regions where the inertia forces are significantly larger than the viscous flow.

Experimental observations show that when the flow field region is away from a solid body, the inviscid flow is an appropriate model to approximate the flow. In this way, the viscosity effects can be viewed as a mechanism in which the information is transferred from the solid body into depth of the flow field. Thus, in a very close proximity to the solid body, the region must be considered as viscous flow. Additionally, the flow far away from the body is an inviscid flow. The connection between these regions was proposed by Prandtl and it is referred as the boundary layer.

The motivations or benefits for such analysis are more than the reduction of mathematical complexity. As it was indicated earlier, this analysis provides an adequate solution for some regions. Furthermore the Potential Flow analysis provides several concepts that obscured by other effects. These flow patterns or pressure gradients reveal several “laws” such as Bernoulli's theorem, vortex/lift etc which will be expanded. There are several unique concepts which appear in potential flow such as Add Mass, Add Force, and Add Moment of Inertia otherwise they are obscured with inviscid flow.

These aspects are very important in certain regions which can be evaluated using dimensional analysis. The determination of what regions or their boundaries is a question of experience or results of a sophisticated dimensional analysis which will be discussed later.

The inviscid flow is applied to incompressible flow as well to compressible flow. However, the main emphasis here is on incompressible flow because the simplicity. The expansion will be suggested when possible.

### 10.1.1 Inviscid Momentum Equations

The Naiver–Stokes equations (equation (8.112), (8.113) and (8.114)) under the discussion above reduced to

Euler Equations in Cartesian Coordinates

$$\begin{aligned} \rho \left( \frac{\partial U_x}{\partial t} + U_x \frac{\partial U_x}{\partial x} + U_y \frac{\partial U_x}{\partial y} + U_z \frac{\partial U_x}{\partial z} \right) &= -\frac{\partial P}{\partial x} + \rho g_x \\ \rho \left( \frac{\partial U_y}{\partial t} + U_x \frac{\partial U_y}{\partial x} + U_y \frac{\partial U_y}{\partial y} + U_z \frac{\partial U_y}{\partial z} \right) &= -\frac{\partial P}{\partial y} + \rho g_y \\ \rho \left( \frac{\partial U_z}{\partial t} + U_x \frac{\partial U_z}{\partial x} + U_y \frac{\partial U_z}{\partial y} + U_z \frac{\partial U_z}{\partial z} \right) &= -\frac{\partial P}{\partial z} + \rho g_z \end{aligned} \quad (10.1)$$

These equations (10.1) are known as Euler's equations in Cartesian Coordinates. Euler equations can be written in a vector form as

$$\rho \frac{D\mathbf{U}}{Dt} = -\nabla P - \nabla \rho \mathbf{g} \ell \quad (10.2)$$

where  $\ell$  represents the distance from a reference point. Where the  $D\mathbf{U}/Dt$  is the material derivative or the substantial derivative. The substantial derivative, in Cartesian Coordinates, is

$$\begin{aligned} \frac{D\mathbf{U}}{Dt} &= \mathbf{i} \left( \frac{\partial U_x}{\partial t} + U_x \frac{\partial U_x}{\partial x} + U_y \frac{\partial U_x}{\partial y} + U_z \frac{\partial U_x}{\partial z} \right) \\ &+ \mathbf{j} \left( \frac{\partial U_y}{\partial t} + U_x \frac{\partial U_y}{\partial x} + U_y \frac{\partial U_y}{\partial y} + U_z \frac{\partial U_y}{\partial z} \right) \\ &+ \mathbf{k} \left( \frac{\partial U_z}{\partial t} + U_x \frac{\partial U_z}{\partial x} + U_y \frac{\partial U_z}{\partial y} + U_z \frac{\partial U_z}{\partial z} \right) \end{aligned} \quad (10.3)$$

In the following derivations, the identity of the partial derivative is used

$$U_i \frac{\partial U_i}{\partial i} = \frac{1}{2} \frac{\partial (U_i)^2}{\partial i} \quad (10.4)$$

where in this case  $i$  is  $x$ ,  $y$ , and  $z$ . The convective term (not time derivatives) in  $x$  direction of equation (10.3) can be manipulated as

$$\begin{aligned}
 U_x \frac{\partial U_x}{\partial x} + U_y \frac{\partial U_x}{\partial y} + U_z \frac{\partial U_x}{\partial z} &= \frac{1}{2} \frac{\partial (U_x)^2}{\partial x} + \\
 &\underbrace{U_y \frac{\partial U_y}{\partial x}}_{\substack{=0 \\ \frac{1}{2} \frac{\partial (U_y)^2}{\partial x}}} + \underbrace{U_y \left( \frac{\partial U_x}{\partial y} - \frac{\partial U_y}{\partial x} \right)}_{\text{blue}} + \underbrace{U_z \frac{\partial U_z}{\partial x}}_{\substack{=0 \\ \frac{1}{2} \frac{\partial (U_z)^2}{\partial x}}} + \underbrace{U_z \left( \frac{\partial U_x}{\partial z} - \frac{\partial U_z}{\partial x} \right)}_{\text{red-violet}} + U_z \frac{\partial U_x}{\partial z} \quad (10.5)
 \end{aligned}$$

It can be noticed that equation (10.5) several terms were added and subtracted according to equation (10.4). These two groups are marked with the underbrace and equal to zero. The two terms in blue of equation (10.5) can be combined (see for the overbrace). The same can be done for the two terms in the red–violet color. Hence, equation (10.5) by combining all the “green” terms can be transformed into

$$\begin{aligned}
 U_x \frac{\partial U_x}{\partial x} + U_y \frac{\partial U_x}{\partial y} + U_z \frac{\partial U_x}{\partial z} &= \frac{1}{2} \frac{\partial (U_x)^2}{\partial x} + \frac{1}{2} \frac{\partial (U_y)^2}{\partial x} + \frac{1}{2} \frac{\partial (U_z)^2}{\partial x} + \\
 &U_y \left( \frac{\partial U_x}{\partial y} - \frac{\partial U_y}{\partial x} \right) + U_z \left( \frac{\partial U_x}{\partial z} - \frac{\partial U_z}{\partial x} \right) \quad (10.6)
 \end{aligned}$$

The, “green” terms, all the velocity components can be combined because of the Pythagorean theorem to form

$$\frac{1}{2} \frac{\partial (U_x)^2}{\partial x} + \frac{1}{2} \frac{\partial (U_y)^2}{\partial x} + \frac{1}{2} \frac{\partial (U_z)^2}{\partial x} = \frac{\partial (\mathbf{U})^2}{\partial x} \quad (10.7)$$

Hence, equation (10.6) can be written as

$$\begin{aligned}
 U_x \frac{\partial U_x}{\partial x} + U_y \frac{\partial U_x}{\partial y} + U_z \frac{\partial U_x}{\partial z} &= \frac{\partial (\mathbf{U})^2}{\partial x} \\
 &+ U_y \left( \frac{\partial U_x}{\partial y} - \frac{\partial U_y}{\partial x} \right) + U_z \left( \frac{\partial U_x}{\partial z} - \frac{\partial U_z}{\partial x} \right) \quad (10.8)
 \end{aligned}$$

In the same fashion equation for  $y$  direction can be written as

$$\begin{aligned}
 U_x \frac{\partial U_y}{\partial x} + U_y \frac{\partial U_y}{\partial y} + U_z \frac{\partial U_y}{\partial z} &= \frac{\partial (\mathbf{U})^2}{\partial y} \\
 &+ U_x \left( \frac{\partial U_y}{\partial x} - \frac{\partial U_x}{\partial y} \right) + U_z \left( \frac{\partial U_y}{\partial z} - \frac{\partial U_z}{\partial y} \right) \quad (10.9)
 \end{aligned}$$

and for the  $z$  direction as

$$U_x \frac{\partial U_z}{\partial x} + U_y \frac{\partial U_z}{\partial y} + U_z \frac{\partial U_z}{\partial z} = \frac{\partial (\mathbf{U})^2}{\partial y} + U_x \left( \frac{\partial U_z}{\partial x} - \frac{\partial U_x}{\partial z} \right) + U_y \left( \frac{\partial U_z}{\partial y} - \frac{\partial U_y}{\partial z} \right) \quad (10.10)$$

Hence equation (10.3) can be written as

$$\begin{aligned} \frac{\mathbf{D}\mathbf{U}}{\mathbf{D}t} &= \mathbf{i} \left( \frac{\partial U_x}{\partial t} + \frac{\partial (\mathbf{U})^2}{\partial x} + U_y \left( \frac{\partial U_x}{\partial y} - \frac{\partial U_y}{\partial x} \right) + U_z \left( \frac{\partial U_x}{\partial z} - \frac{\partial U_z}{\partial x} \right) \right) \\ &+ \mathbf{j} \left( \frac{\partial U_y}{\partial t} + \frac{\partial (\mathbf{U})^2}{\partial y} + U_x \left( \frac{\partial U_y}{\partial x} - \frac{\partial U_x}{\partial y} \right) + U_z \left( \frac{\partial U_y}{\partial z} - \frac{\partial U_z}{\partial y} \right) \right) \\ &+ \mathbf{k} \left( \frac{\partial U_z}{\partial t} + \frac{\partial (\mathbf{U})^2}{\partial z} + U_x \left( \frac{\partial U_z}{\partial x} - \frac{\partial U_x}{\partial z} \right) + U_y \left( \frac{\partial U_z}{\partial y} - \frac{\partial U_y}{\partial z} \right) \right) \end{aligned} \quad (10.11)$$

All the time derivatives can be combined also the derivative of the velocity square (notice the color coding) as

$$\begin{aligned} \frac{\mathbf{D}\mathbf{U}}{\mathbf{D}t} &= \frac{\partial \mathbf{U}}{\partial t} + \nabla (\mathbf{U})^2 + \mathbf{i} \left( U_y \left( \frac{\partial U_x}{\partial y} - \frac{\partial U_y}{\partial x} \right) + U_z \left( \frac{\partial U_x}{\partial z} - \frac{\partial U_z}{\partial x} \right) \right) \\ &+ \mathbf{j} \left( U_x \left( \frac{\partial U_y}{\partial x} - \frac{\partial U_x}{\partial y} \right) + U_z \left( \frac{\partial U_y}{\partial z} - \frac{\partial U_z}{\partial y} \right) \right) \\ &+ \mathbf{k} \left( U_x \left( \frac{\partial U_z}{\partial x} - \frac{\partial U_x}{\partial z} \right) + U_y \left( \frac{\partial U_z}{\partial y} - \frac{\partial U_y}{\partial z} \right) \right) \end{aligned} \quad (10.12)$$

Using vector notation the terms in the parenthesis can be represent as

$$\begin{aligned} \text{curl } \mathbf{U} = \nabla \times \mathbf{U} &= \mathbf{i} \left( \frac{\partial U_z}{\partial y} - \frac{\partial U_y}{\partial z} \right) + \mathbf{j} \left( \frac{\partial U_x}{\partial z} - \frac{\partial U_z}{\partial x} \right) \\ &+ \mathbf{k} \left( \frac{\partial U_y}{\partial x} - \frac{\partial U_x}{\partial y} \right) \end{aligned} \quad (10.13)$$

With the identity in (10.13) can be extend as

$$\begin{aligned} \mathbf{U} \times \nabla \times \mathbf{U} = & -\mathbf{i} \left( U_y \left( \frac{\partial U_x}{\partial y} - \frac{\partial U_y}{\partial x} \right) + U_z \left( \frac{\partial U_x}{\partial z} - \frac{\partial U_z}{\partial x} \right) \right) \\ & -\mathbf{j} \left( U_x \left( \frac{\partial U_y}{\partial x} - \frac{\partial U_x}{\partial y} \right) + U_z \left( \frac{\partial U_y}{\partial z} - \frac{\partial U_z}{\partial y} \right) \right) \\ & -\mathbf{k} \left( U_x \left( \frac{\partial U_z}{\partial x} - \frac{\partial U_x}{\partial z} \right) + U_y \left( \frac{\partial U_z}{\partial y} - \frac{\partial U_y}{\partial z} \right) \right) \quad (10.14) \end{aligned}$$

The identity described in equation (10.14) is substituted into equation (10.12) to obtain the form of

$$\frac{D\mathbf{U}}{Dt} = \frac{\partial \mathbf{U}}{\partial t} + \nabla (\mathbf{U})^2 - \mathbf{U} \times \nabla \times \mathbf{U} \quad (10.15)$$

Finally substituting equation (10.15) into the Euler equation to obtain a more convenient form as

$$\rho \left( \frac{\partial \mathbf{U}}{\partial t} + \nabla (\mathbf{U})^2 - \mathbf{U} \times \nabla \times \mathbf{U} \right) = -\nabla P - \nabla \rho \mathbf{g} \ell \quad (10.16)$$

A common assumption that employed in an isothermal flow is that density,  $\rho$ , is a mere function of the static pressure,  $\rho = \rho(P)$ . According to this idea, the density is constant when the pressure is constant. The mathematical interpretation of the pressure gradient can be written as

$$\nabla P = \frac{dP}{dn} \hat{\mathbf{n}} \quad (10.17)$$

where  $\hat{\mathbf{n}}$  is an unit vector normal to surface of constant property and the derivative  $d/dn$  refers to the derivative in the direction of  $\hat{\mathbf{n}}$ . Dividing equation (10.17) by the density,  $\rho$ , yields

$$\frac{\nabla P}{\rho} = \frac{1}{dn} \frac{dP}{\rho} \hat{\mathbf{n}} = \frac{1}{dn} \overbrace{d \int}^{\text{zero net effect}} \left( \frac{dP}{\rho} \right) \hat{\mathbf{n}} = \frac{d}{dn} \int \left( \frac{dP}{\rho} \right) \hat{\mathbf{n}} = \nabla \int \left( \frac{dP}{\rho} \right) \quad (10.18)$$

It can be noticed that taking a derivative after integration cancel both effects. The derivative in the direction of  $\hat{\mathbf{n}}$  is the gradient. This function is normal to the constant of pressure,  $P$ , and therefore  $\int (dP/\rho)$  is function of the mere pressure.

Substituting equation (10.18) into equation (10.16) and collecting all terms under the gradient yields

$$\frac{\partial \mathbf{U}}{\partial t} + \nabla \left( \frac{\mathbf{U}^2}{2} + \mathbf{g} \ell + \int \left( \frac{dP}{\rho} \right) \right) = \mathbf{U} \times \nabla \times \mathbf{U} \quad (10.19)$$

The quantity  $\nabla \times \mathbf{U}$  is referred in the literature as the vorticity and it represents the rotation of the liquid.

$$\boldsymbol{\Omega} \equiv \nabla \times \mathbf{U} \quad (10.20)$$

The definition (10.20) substituted into equation (10.19) provides

Euler Equation or Inviscid Flow
$\frac{\partial \mathbf{U}}{\partial t} + \nabla \left( \frac{U^2}{2} + \mathbf{g} \ell + \int \left( \frac{dP}{\rho} \right) \right) = \mathbf{U} \times \boldsymbol{\Omega}$

(10.21)

One of the fundamental condition is referred to as irrotational flow. In this flow, the vorticity is zero in the entire flow field. Hence, equation (10.21) under irrotational flow reduced into

Bernoulli Equation
$\frac{\partial \mathbf{U}}{\partial t} + \nabla \left( \frac{U^2}{2} + \mathbf{g} \ell + \int \left( \frac{dP}{\rho} \right) \right) = 0$

(10.22)

For steady state condition equation (10.24) is further reduced when the time derivative drops and carry the integration (to cancel the gradient) to became

Steady State Bernoulli Equation
$\frac{U^2}{2} + \mathbf{g} \ell + \int \left( \frac{dP}{\rho} \right) = c$

(10.23)

It has to be emphasized that the symbol  $\ell$  denotes the length in the direction of the body force. For the special case where the density is constant, the Bernoulli equation is reduced to

Constant Density Steady State Bernoulli Equation
$\frac{U^2}{2} + \mathbf{g} \ell + \frac{P}{\rho} = c$

(10.24)

The streamline is a line tangent to velocity vector. For the unsteady state the streamline change their location or position. The direction derivative along the streamline depends the direction of the streamline. The direction of the tangent is

$$\hat{\ell} = \frac{\mathbf{U}}{U} \quad (10.25)$$

Multiplying equation (10.21) by the unit direction of the streamline as a dot product results in

$$\frac{\mathbf{U}}{U} \cdot \frac{\partial \mathbf{U}}{\partial t} + \frac{\mathbf{U}}{U} \cdot \nabla \left( \frac{U^2}{2} + \mathbf{g} \ell + \int \left( \frac{dP}{\rho} \right) \right) = \frac{\mathbf{U}}{U} \cdot \mathbf{U} \times \boldsymbol{\Omega} \quad (10.26)$$



The partial derivative of any vector,  $\mathbf{\Upsilon}$ , with respect to time is the same direction as the unit vector. Hence, the product of multiplication of the partial derivative with an unit vector is

$$\frac{\partial \mathbf{\Upsilon}}{\partial \ell} \cdot \left( \frac{\mathbf{\Upsilon}}{\Upsilon} \right) = \frac{\partial \Upsilon}{\partial \ell} \quad (10.27)$$

where  $\mathbf{\Upsilon}$  is any vector and  $\Upsilon$  its magnitude. The right hand side of equation (10.26)  $\mathbf{U} \times \boldsymbol{\Omega}$  is perpendicular to both vectors  $\mathbf{U}$  and  $\boldsymbol{\Omega}$ . Hence, the dot product of vector  $\mathbf{U}$  with a vector perpendicular to itself must be zero. Thus equation (10.26) becomes

$$\frac{\partial \mathbf{U}}{\partial t} + \overbrace{\frac{d}{d\ell}}^{\mathbf{U} \cdot \nabla} \left( \frac{\mathbf{U}^2}{2} + \mathbf{g}\ell + \int \left( \frac{dP}{\rho} \right) \right) = \overbrace{\mathbf{U} \cdot \mathbf{U} \times \boldsymbol{\Omega}}^{=0} \quad (10.28)$$

or

$$\frac{\partial \mathbf{U}}{\partial t} + \frac{d}{d\ell} \left( \frac{\mathbf{U}^2}{2} + \mathbf{g}\ell + \int \left( \frac{dP}{\rho} \right) \right) = 0 \quad (10.29)$$

The first time derivative of equation (10.28) can be manipulated as it was done before to get into derivative as

$$\frac{\partial \mathbf{U}}{\partial t} = \frac{d}{d\ell} \int \frac{\partial \mathbf{U}}{\partial t} d\ell \quad (10.30)$$

Substituting into equation (10.28) writes

$$\frac{d}{d\ell} \left( \frac{\partial \mathbf{U}}{\partial t} + \frac{\mathbf{U}^2}{2} + \mathbf{g}\ell + \int \left( \frac{dP}{\rho} \right) \right) = 0 \quad (10.31)$$

The integration with respect or along stream line, " $\ell$ " is a function of time (similar integration with respect  $x$  is a function of  $y$ .) and hence equation (10.28) becomes

Bernoulli On A Streamline

$$\frac{\partial \mathbf{U}}{\partial t} + \frac{\mathbf{U}^2}{2} + \mathbf{g}\ell + \int \left( \frac{dP}{\rho} \right) = f(t) \quad (10.32)$$

In these derivations two cases were analyzed the first case, for irrotational Bernoulli's equation is applied any where in the flow field. This requirement means that the flow field must obey  $\mathbf{U} \times \boldsymbol{\Upsilon}$ . The second requirement regardless whether the flow is irrotational or not, must be along a streamline where the value is only function of the time and not location. The confusion transpires because these two cases are referred as the Bernoulli equation while they refer to two different conditions or situations<sup>1</sup>. For both Bernoulli equations the viscosity must be zero.

<sup>1</sup>It is interesting to point out that these equations were developed by Euler but credited to the last D. Bernoulli. A discussion on this point can be found in Hunter's book at Rouse, Hunter, and Simon Ince. History of hydraulics. Vol. 214. Ann Arbor, MI: Iowa Institute of Hydraulic Research, State University of Iowa, 1957.

## 10.2 Potential Flow Function

The two different Bernoulli equations suggest that some mathematical manipulations can provide several points of understating. These mathematical methods are known as potential flow. The potential flow is defined as the gradient of the scalar function (thus it is a vector) is the following

$$\mathbf{U} \equiv \nabla\phi \quad (10.33)$$

The potential function is three dimensional and time dependent in the most expanded case. The vorticity was supposed to be zero for the first Bernoulli equation. According to the definition of the vorticity it has to be

$$\Omega = \nabla \times \mathbf{U} = \nabla \times \nabla\phi \quad (10.34)$$

The above identity is shown to be zero for continuous function as

$$\begin{aligned} \nabla \times \overbrace{\left( \mathbf{i} \frac{\partial\phi}{\partial x} + \mathbf{j} \frac{\partial\phi}{\partial y} + \mathbf{k} \frac{\partial\phi}{\partial z} \right)}^{\nabla\phi} &= \mathbf{i} \left( \frac{\partial^2\phi}{\partial y\partial z} - \frac{\partial^2\phi}{\partial z\partial y} \right) \\ &+ \mathbf{j} \left( \frac{\partial^2\phi}{\partial z\partial x} - \frac{\partial^2\phi}{\partial x\partial z} \right) + \mathbf{k} \left( \frac{\partial^2\phi}{\partial y\partial x} - \frac{\partial^2\phi}{\partial x\partial y} \right) \end{aligned} \quad (10.35)$$

According to Clairaut's theorem (or Schwarz's theorem)<sup>2</sup> the mixed derivatives are identical  $\partial_{xy} = \partial_{yx}$ . Hence every potential flow is irrotational flow. On the reverse side, it can be shown that if the flow is irrotational then there is a potential function that satisfies the equation (10.33) which describes the flow. Thus, every irrotational flow is potential flow and conversely. In these two terms are interchangeably and no difference should be assumed.

Substituting equation (10.33) into (10.24) results in

$$\frac{\partial\nabla\phi}{\partial t} + \nabla \left( \frac{(\nabla\phi)^2}{2} + \mathbf{g}\ell + \int \left( \frac{dP}{\rho} \right) \right) = 0 \quad (10.36)$$

It can be noticed that the order derivation can be changed so

$$\frac{\partial\nabla\phi}{\partial t} = \nabla \frac{\partial\phi}{\partial t} \quad (10.37)$$

Hence, equation (10.36) can be written as

$$\nabla \left( \frac{\partial\phi}{\partial t} + \frac{(\nabla\phi)^2}{2} + \mathbf{g}\ell + \int \left( \frac{dP}{\rho} \right) \right) = 0 \quad (10.38)$$

<sup>2</sup>Hazewinkel, Michiel, ed. (2001), "Partial derivative", Encyclopedia of Mathematics, Springer, ISBN 978-1-55608-010-4

The integration with respect the space and not time results in the

Euler Equation or Inviscid Flow

$$\frac{\partial \phi}{\partial t} + \frac{(\nabla \phi)^2}{2} + \mathbf{g} \ell + \int \left( \frac{dP}{\rho} \right) = f(t) \quad (10.39)$$

Example 10.1:

The potential function is given by  $\phi = x^2 - y^4 + 5$ . Calculate the velocity component in Cartesian Coordinates.

SOLUTION

The velocity can be obtained by applying gradient on the potential  $U = \nabla \phi$  as

$$\begin{aligned} V_x &= \frac{\partial \phi}{\partial x} = 2x \\ V_y &= \frac{\partial \phi}{\partial y} = -4y^3 \\ V_z &= \frac{\partial \phi}{\partial z} = 0 \end{aligned} \quad (10.1.a)$$

---

End Solution

### 10.2.1 Streamline and Stream function

The streamline was mentioned in the earlier section and now the focus is on this issue. A streamline is a line that represent the collection of all the point where the velocity is tangent to the velocity vector. Equation (10.25) represents the unit vector. The total differential is made of three components as

$$\hat{\ell} = \hat{\mathbf{i}} \frac{U_x}{U} + \hat{\mathbf{j}} \frac{U_y}{U} + \hat{\mathbf{k}} \frac{U_z}{U} = \hat{\mathbf{i}} \frac{dx}{d\ell} + \hat{\mathbf{j}} \frac{dy}{d\ell} + \hat{\mathbf{k}} \frac{dz}{d\ell} \quad (10.40)$$

It can be noticed that  $dx/d\ell$  is  $x$  component of the unit vector in the direction of  $x$ . The discussion proceed from equation (10.40) that

$$\frac{U_x}{dx} = \frac{U_y}{dy} = \frac{U_z}{dz} \quad (10.41)$$

Equation (10.41) suggests a system of three ordinary differential equations as a way to find the stream function. For example, in the  $x$ - $y$  plane the ordinary differential equation is

$$\frac{dy}{dx} = \frac{U_y}{U_x} \quad (10.42)$$

Example 10.2:

What are stream lines that should be obtained in Example 10.1.

SOLUTION

Utilizing equation (10.42) results in

$$\frac{dy}{dx} = \frac{U_y}{U_x} = \frac{-4y^3}{2x} \quad (10.11.a)$$

The solution of the non-linear ordinary differential obtained by separation of variables as

$$-\frac{dy}{2y^3} = \frac{dx}{2x} \quad (10.11.b)$$

The solution of equation streamLineSimple:separation is obtained by integration as

$$\frac{1}{4y^2} = \ln x + C \quad (10.11.c)$$

End Solution

From the discussion above it follows that streamlines are continuous if the velocity field is continuous. Hence, several streamlines can be drawn in the field as shown in Figure 10.1. If two streamlines (blue) are close an arbitrary line (brown line) can be drawn to connect these lines. A unit vector (cyan) can be drawn perpendicular to the brown line. The velocity vector is almost parallel (tangent) to the streamline (since the streamlines are very close) to both streamlines. Depending on the orientation of the connecting line (brown line) the direction of the unit vector is determined. Denoting a stream function as  $\psi$  which in the two dimensional case is only function of  $x, y$ , that is

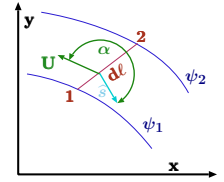

Fig. -10.1. Streamlines to explain stream function.

$$\psi = f(x, y) \implies d\psi = \frac{\partial\psi}{\partial x} dx + \frac{\partial\psi}{\partial y} dy \quad (10.43)$$

In this stage, no meaning is assigned to the stream function. The differential of stream function is defined as

$$d\psi = \mathbf{U} \cdot \hat{s} d\ell \quad (10.44)$$

The term  $d\ell$  refers to a small straight element line connecting two streamlines close to each other. It could be viewed as a function as some representing the accumulative of the velocity. The physical meaning is needed to be connected with the previous discussion of the two dimensional function. If direction of the  $\ell$  is chosen in a such away that it is in the direction of  $x$  as shown in Figure 10.2(a). In that case the  $\hat{s}$  in

the direction of  $-\hat{j}$  as shown in the Figure 10.2(a). In this case, the stream function differential is

$$d\psi = \frac{\partial\psi}{\partial x} dx + \frac{\partial\psi}{\partial y} dy = (\hat{i}U_x + \hat{j}U_y) \cdot \left( -\hat{j} \right) \frac{d\ell}{dx} = -U_y dx \quad (10.45)$$

In this case, the conclusion is that

$$\frac{\partial\psi}{\partial x} = -U_y \quad (10.46)$$

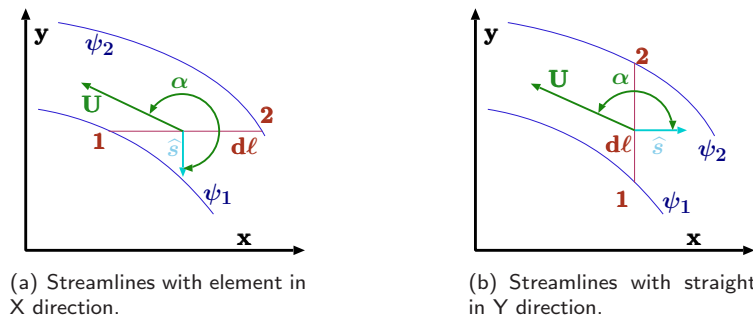

Fig. -10.2. Streamlines with different element in different direction to explain stream function.

On the other hand, if  $d\ell$  in the  $y$  direction as shown in Figure 10.16(b) then  $\hat{s} = \hat{i}$  as shown in the Figure.

$$d\psi = \frac{\partial\psi}{\partial x} dx + \frac{\partial\psi}{\partial y} dy = (\hat{i}U_x + \hat{j}U_y) \cdot \left( \hat{i} \right) \frac{d\ell}{dy} = U_x dy \quad (10.47)$$

In this case the conclusion is the

$$\frac{\partial\psi}{\partial y} = U_x \quad (10.48)$$

Thus, substituting equation (10.46) and (10.48) into (10.43) yields

$$U_x dy - U_y dx = 0 \quad (10.49)$$

It follows that the requirement on  $U_x$  and  $U_y$  have to satisfy the above equation which leads to the conclusion that the full differential is equal to zero. Hence, the function must be constant  $\psi = 0$ .

It also can be observed that the continuity equation can be represented by the stream function. The continuity equation is

$$\frac{\partial \mathbf{U}_x}{\partial x} + \frac{\partial \mathbf{U}_y}{\partial y} = 0 \quad (10.50)$$

Substituting for the velocity components the stream function equation (10.46) and (10.46) yields

$$\frac{\partial^2 \psi}{\partial x \partial y} - \frac{\partial^2 \psi}{\partial y \partial x} = 0 \quad (10.51)$$

In addition the flow rate,  $\dot{Q}$  can be calculated across a line. It can be noticed that flow rate can be calculated as the integral of the perpendicular component of the velocity or the perpendicular component of the cross line as

$$\dot{Q} = \int_1^2 \mathbf{U} \cdot \hat{s} \, dl \quad (10.52)$$

According the definition  $d\psi$  it is

$$\dot{Q} = \int_1^2 \mathbf{U} \cdot \hat{s} \, dl = \int_1^2 d\psi = \psi_2 - \psi_1 \quad (10.53)$$

Hence the flow rate is represented by the value of the stream function. The difference between two stream functions is the actual flow rate.

In this discussion, the choice of the coordinates orientation was arbitrary. Hence equations (10.46) and (10.48) are orientation dependent. The natural direction is the shortest distance between two streamlines. The change between two streamlines is

$$d\psi = \mathbf{U} \cdot \hat{n} \, dn \implies d\psi = U \, dn \implies \frac{d\psi}{dn} = U \quad (10.54)$$

where  $dn$  is  $dl$  perpendicular to streamline (the shortest possible  $dl$ ).

The stream function properties can be summarized to satisfy the continuity equation, and the difference two stream functions represent the flow rate. A by-product of the previous conclusion is that the stream function is constant along the stream line. This conclusion also can be deduced from the fact no flow can cross the streamline.

## 10.2.2 Compressible Flow Stream Function

The stream function can be defined also for the compressible flow substances and steady state. The continuity equation is used as the base for the derivations. The continuity equation for compressible substance is

$$\frac{\partial \rho \mathbf{U}_x}{\partial x} + \frac{\partial \rho \mathbf{U}_y}{\partial y} = 0 \quad (10.55)$$

To absorb the density, dimensionless density is inserted into the definition of the stream function as

$$\frac{\partial\psi}{\partial y} = \frac{\rho U_x}{\rho_0} \quad (10.56)$$

and

$$\frac{\partial\psi}{\partial x} = -\frac{\rho U_y}{\rho_0} \quad (10.57)$$

Where  $\rho_0$  is the density at a location or a reference density. Note that the new stream function is not identical to the previous definition and they cannot be combined.

The stream function, as it was shown earlier, describes (constant) stream lines. Using the same argument in which equation (10.46) and equation (10.48) were developed leads to equation (10.49) and there is no difference between compressible flow and incompressible flow case. Substituting equations (10.56) and (10.57) into equation (10.49) yields

$$\left( \frac{\partial\psi}{\partial y} dy + \frac{\partial\psi}{\partial x} dx \right) \frac{\rho_0}{\rho} = \frac{\rho_0}{\rho} d\psi \quad (10.58)$$

Equation suggests that the stream function should be redefined so that similar expressions to incompressible flow can be developed for the compressible flow as

$$d\psi = \frac{\rho_0}{\rho} \mathbf{U} \cdot \hat{s} d\ell \quad (10.59)$$

With the new definition, the flow crossing the line 1 to 2, utilizing the new definition of (10.59) is

$$\dot{m} = \int_1^2 \rho \mathbf{U} \cdot \hat{s} d\ell = \rho_0 \int_1^2 d\psi = \rho_0 (\psi_2 - \psi_1) \quad (10.60)$$

### 10.2.2.1 Stream Function in a Three Dimensions

Pure three dimensional stream functions exist physically but at present there is no known way to represent them mathematically. One of the ways that was suggested by Yih in 1957<sup>34</sup> suggested using two stream functions to represent the three dimensional flow. The only exception is a stream function for three dimensional flow exists but only for axisymmetric flow i.e the flow properties remains constant in one of the direction (say z axis).

— — — — — *Advance material can be skipped* — — — — —

The three dimensional representation is based on the fact the continuity equation must be satisfied. In this case it will be discussed only for incompressible flow. The

<sup>3</sup>C.S. Yih "Stream Functions in Three-Dimensional Flows," La houille blanche, Vol 12. 3 1957

<sup>4</sup> Giese, J.H. 1951. "Stream Functions for Three-Dimensional Flows", J. Math. Phys., Vol.30, pp. 31-35.

$\nabla \mathbf{U} = 0$  and vector identity of  $\nabla \cdot \nabla \mathbf{U} = 0$  where in this case  $\mathbf{U}$  is any vector. As opposed to two dimensional case, the stream function is defined as a vector function as

$$\mathbf{B} = \psi \nabla \xi \quad (10.61)$$

The idea behind this definition is to build stream function based on two scalar functions one provide the “direction” and one provides the the magnitude. In that case, the velocity (to satisfy the continuity equation)

$$\mathbf{U} = \nabla \times (\psi \nabla \chi) \quad (10.62)$$

where  $\psi$  and  $\chi$  are scalar functions. Note while  $\psi$  is used here is not the same stream functions that were used in previous cases. The velocity can be obtained by expanding equation (10.62) to obtained

$$\mathbf{U} = \nabla \psi \times \nabla \chi + \psi \overbrace{\nabla \times (\nabla \chi)}^{=0} \quad (10.63)$$

The second term is zero for any operation of scalar function and hence equation (10.63) becomes

$$\mathbf{U} = \nabla \psi \times \nabla \chi \quad (10.64)$$

These derivations demonstrates that the velocity is orthogonal to two gradient vectors. In another words, the velocity is tangent to the surfaces defined by  $\psi = \text{constant}$  and  $\chi = \text{constant}$ . Hence, these functions,  $\psi$  and  $\chi$  are possible stream functions in three dimensions fields. It can be shown that the flow rate is

$$\dot{Q} = (\psi_2 - \psi_1) (\chi - \chi_1) \quad (10.65)$$

The answer to the question whether this method is useful and effective is that in some limited situations it could help. In fact, very few research papers deals this method and currently there is not analytical alternative. Hence, this method will not be expanded here.

— — — — — *End Advance material* — — — — —

### 10.2.3 The Connection Between the Stream Function and the Potential Function

For this discussion, the situation of two dimensional incompressible is assumed. It was shown that

$$U_x = \frac{\partial \phi}{\partial x} = \frac{\partial \psi}{\partial y} \quad (10.66)$$

and

$$U_y = \frac{\partial \phi}{\partial y} = -\frac{\partial \psi}{\partial x} \quad (10.67)$$



These equations (10.66) and (10.67) are referred to as the Cauchy–Riemann equations.

Definition of the potential function is based on the gradient operator as  $U = \nabla\phi$  thus derivative in arbitrary direction can be written as

$$\frac{d\phi}{ds} = \nabla\phi \cdot \hat{s} = U \cdot \hat{s} \tag{10.68}$$

where  $ds$  is arbitrary direction and  $\hat{s}$  is unit vector in that direction. If  $s$  is selected in the streamline direction, the change in the potential function represent the change in streamline direction. Choosing element in the direction normal of the streamline and denoting it as  $dn$  and choosing the sign to possible in the same direction of the stream function it follows that

$$U = \frac{d\phi}{ds} \tag{10.69}$$

If the derivative of the stream function is chosen in the direction of the flow then as in was shown in equation (10.54). It summarized as

$$\frac{d\phi}{ds} = \frac{d\psi}{dn} \tag{10.70}$$

There are several conclusions that can be drawn from the derivations above. The conclusion from equation (10.70) that the stream line are orthogonal to potential lines. Since the streamline represent constant value of stream function it follows that the potential lines are constant as well. The line of constant value of the potential are referred as potential lines.

In Figure 10.4 describes almost a standard case of stream lines and potential lines.

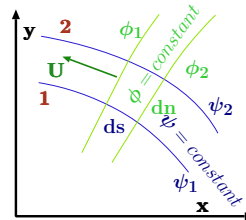

Fig. -10.3. Constant Stream lines and Constant Potential lines.

**Example 10.3:**

A two dimensional stream function is given as  $\psi = x^4 - y^2$ . Calculate the expression for the potential function  $\phi$  (constant value) and sketch the streamlines lines (of constant value).

SOLUTION

Utilizing the differential equation (10.66) and (10.67) to

$$\frac{\partial\phi}{\partial x} = \frac{\partial\psi}{\partial y} = -2y \tag{10.III.a}$$

Integrating with respect to  $x$  to obtain

$$\phi = -2xy + f(y) \tag{10.III.b}$$

<sup>5</sup>This Figure was part of a project by Eliezer Bar-Meir to learn GLE graphic programming language.

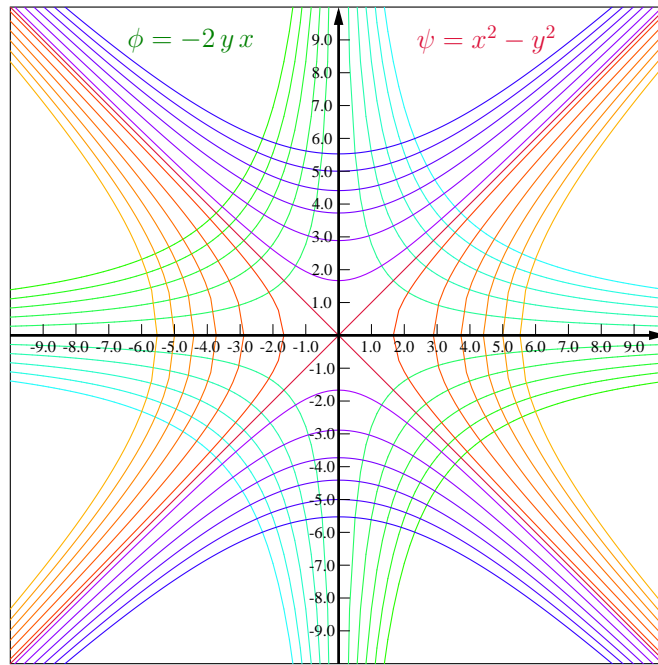

Fig. -10.4. Stream lines and potential lines are drawn as drawn for two dimensional flow. The green to green-turquoise color are the potential lines. Note that opposing quadrants (first and third quadrants) have the same colors. The constant is larger as the color approaches the turquoise color. Note there is no constant equal to zero while for the stream lines the constant can be zero. The stream line are described by the orange to blue lines. The orange lines describe positive constant while the purple lines to blue describe negative constants. The crimson line are for zero constants.<sup>5</sup>

where  $f(y)$  is arbitrary function of  $y$ . Utilizing the other relationship ((10.66)) leads

$$\frac{\partial \phi}{\partial y} = -2x + \frac{df(y)}{dy} = -\frac{\partial \psi}{\partial x} = -4x^3 \quad (10.71)$$

Therefore

$$\frac{df(y)}{dy} = 2x - 4x^3 \quad (10.72)$$

After the integration the function  $\phi$  is

$$\phi = (2x - 4x^3)y + c \quad (10.III.c)$$

The results are shown in Figure

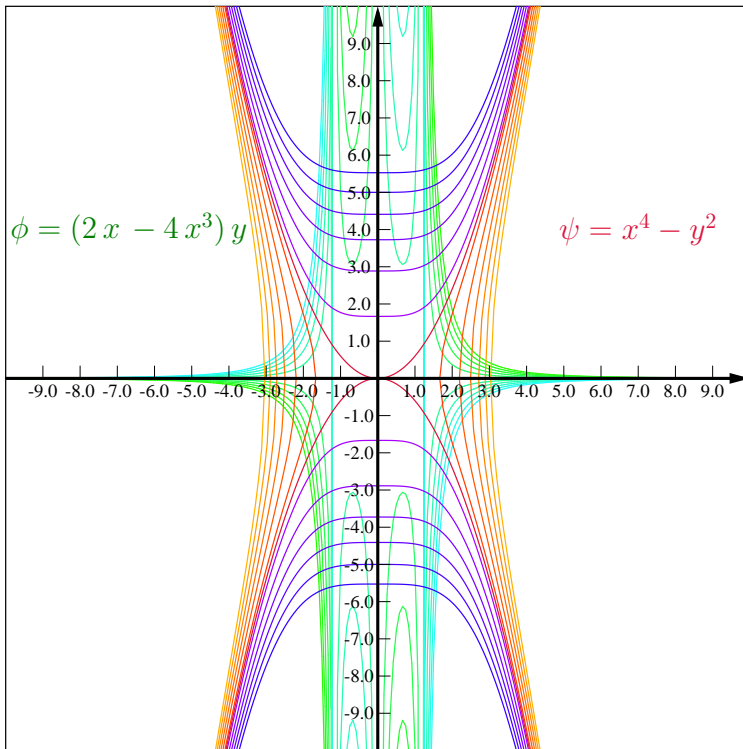

Fig. -10.5. Stream lines and potential lines for Example 10.3.

### 10.2.3.1 Existences of Stream Functions

The potential function in order to exist has to have demised vorticity. For two dimensional flow the vorticity, mathematically, is demised when

$$\frac{\partial U_x}{\partial y} - \frac{\partial U_y}{\partial x} = 0 \quad (10.73)$$

The stream function can satisfy this condition when

Stream Function Requirements
$\frac{\partial}{\partial y} \left( \frac{\partial \psi}{\partial y} \right) + \frac{\partial}{\partial x} \left( \frac{\partial \psi}{\partial x} \right) = 0 \implies \frac{\partial^2 \psi}{\partial y^2} + \frac{\partial^2 \psi}{\partial x^2} = 0 \quad (10.74)$

**Example 10.4:**

Is there a potential based on the following stream function

$$\psi = 3x^5 - 2y \quad (10.IV.a)$$

SOLUTION

Equation (10.74) dictates what are the requirements on the stream function. According to this equation the following must be zero

$$\frac{\partial^2 \psi}{\partial y^2} + \frac{\partial^2 \psi}{\partial x^2} \stackrel{?}{=} 0 \quad (10.IV.b)$$

In this case it is

$$0 \stackrel{?}{=} 0 + 60x^3 \quad (10.IV.c)$$

Since  $x^3$  is only zero at  $x = 0$  the requirement is fulfilled and therefore this function cannot be appropriate stream function.

---

End Solution

---

### 10.3 Potential Flow Functions Inventory

This section describes several simple scenarios of the flow field. These flow fields will be described and exhibits utilization of the potential and stream functions. These flow fields can be combined by utilizing superimposing principle.

#### Uniform Flow

The trivial flow is the uniform flow in which the fluid field moves directly and uniformly from one side to another side. This flow is further simplified, that is the coordinates system aligned with to flow so the  $x$ -coordinate in the direction of the flow. In this case the velocity is given by

$$\begin{aligned} U_x &= U_0 \\ U_y &= 0 \end{aligned} \quad (10.75)$$

and according to definitions in this chapter

$$U_x = \frac{\partial \phi}{\partial x} = \frac{\partial \psi}{\partial y} = U_0 \quad (10.76)$$

Hence, it can be obtained that

$$\begin{aligned} \phi &= U_0 x + f_y(y) \\ \psi &= U_0 x + f_x(x) \end{aligned} \quad (10.77)$$

where  $f_y(y)$  is arbitrary function of the  $y$  and  $f_x(x)$  is arbitrary function of  $x$ . In the same time these function have to satisfy the condition

$$U_y = \frac{\partial \phi}{\partial x} \quad \text{and} \quad -\frac{\partial \psi}{\partial x} = 0 \quad (10.78)$$

This condition dictates that

$$\frac{d f_y(y)}{d y} = 0 \quad (10.79)$$

$$\frac{d f_x(x)}{d x} = 0$$

Hence

$$f_y(y) = \text{constant} \implies \phi = U_0 x + \text{constant} \quad (10.80a)$$

$$f_x(x) = \text{constant} \implies \psi = U_0 y + \text{constant} \quad (10.80b)$$

These lines can be exhibits for various constants as shown in Figure below.

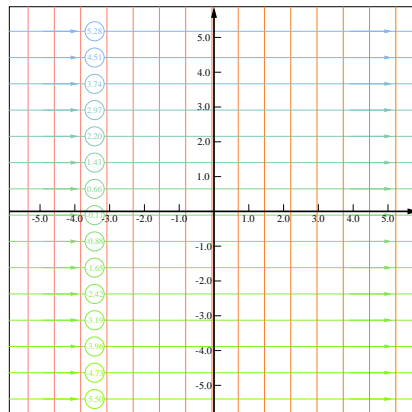

Fig. -10.6. Uniform Flow Streamlines and Potential Lines.

### Line Source and Sink Flow

Another typical flow is a flow from a point or a line in a two dimensional field. This flow is only an idealization of the flow into a single point. Clearly this kind of flow cannot exist because the velocity approaches infinity at the singular point of the source. Yet this idea has its usefulness and is commonly used by many engineers. This idea can be combined with other flow fields and provide a more realistic situation.

The volumetric flow rate (two dimensional)  $\dot{Q}$  denotes the flow rate out or in to control volume into the source or sink. The flow rate is shown in Figure 10.7 is constant for every potential line. The flow rate can be determined by

$$\dot{Q} = 2 \pi r U_r \quad (10.81)$$

Where  $\dot{Q}$  is the volumetric flow rate,  $r$  is distance from the origin and  $U_r$  is the velocity pointing out or into the origin depending whether origin has source or sink. The relationship between the potential function to velocity dictates that

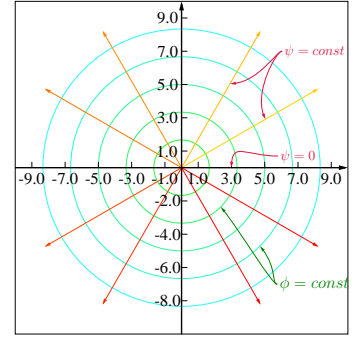

Fig. -10.7. Streamlines and Potential lines due to Source or sink.

$$\nabla \phi = \mathbf{U} = U \hat{\mathbf{r}} = \frac{\dot{Q}}{2 \pi r} \hat{\mathbf{r}} \quad (10.82)$$

Explicitly writing the gradient in cylindrical coordinate results as

$$\frac{\partial \phi}{\partial r} \hat{\mathbf{r}} + \frac{1}{r} \frac{\partial \phi}{\partial \theta} \hat{\boldsymbol{\theta}} + \frac{\partial \phi}{\partial z} \hat{\mathbf{z}} = \frac{\dot{Q}}{2 \pi r} \hat{\mathbf{r}} + 0 \hat{\boldsymbol{\theta}} + 0 \hat{\mathbf{z}} \quad (10.83)$$

Equation (10.83) the gradient components must satisfy the following

$$\begin{aligned} \frac{\partial \phi}{\partial r} &= \frac{\dot{Q}}{2 \pi r} \hat{\mathbf{r}} \\ \frac{\partial \phi}{\partial z} &= \frac{\partial \phi}{\partial \theta} = 0 \end{aligned} \quad (10.84)$$

The integration of equation results in

$$\phi - \phi_0 = \frac{\dot{Q}}{2 \pi r} \ln \frac{r}{r_0} \quad (10.85)$$

where  $r_0$  is the radius at a known point and  $\phi_0$  is the potential at that point. The stream function can be obtained by similar equations that were used or Cartesian coordinates. In the same fashion it can be written that

$$d\psi = \mathbf{U} \cdot \hat{\mathbf{s}} d\ell \quad (10.86)$$

Where in this case  $d\ell = r d\theta$  (the shortest distance between two adjoining stream lines is perpendicular to both lines) and hence equation (10.87) is

$$d\psi = \mathbf{U} \cdot r d\theta \hat{\mathbf{r}} = \frac{\dot{Q}}{2 \pi r} r d\theta = \frac{\dot{Q}}{2 \pi} d\theta \quad (10.87)$$

Note that the direction of  $\mathbf{U}$  and  $\hat{\mathbf{r}}$  is identical. The integration of equation (10.87) yields

$$\psi - \psi_0 = \frac{\dot{Q}}{2\pi r} (\theta - \theta_0) \tag{10.88}$$

It traditionally chosen that the stream function  $\psi_0$  is zero at  $\theta = 0$ . This operation is possible because the integration constant and the arbitrary reference.

In the case of the sink rather than the source, the velocity is in the opposite direction. Hence the flow rate is negative and the same equations obtained.

$$\phi - \phi_0 = -\frac{\dot{Q}}{2\pi r} \ln \frac{r}{r_0} \tag{10.89}$$

$$\psi - \psi_0 = -\frac{\dot{Q}}{2\pi r} (\theta - \theta_0) \tag{10.90}$$

**Free Vortex Flow**

As opposed to the radial flow direction (which was discussed under the source and sink) the flow in the tangential direction is referred to as the free vortex flow. Another typical name for this kind of flow is the potential vortex flow. The flow is circulating the origin or another point. The velocity is only a function of the distance from the radius as

$$U_\theta = f(r) \tag{10.91}$$

And in vector notation the flow is

$$\mathbf{U} = \hat{\boldsymbol{\theta}} f(r) \tag{10.92}$$

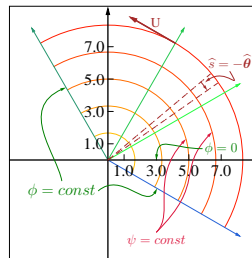

Fig. -10.8. Two dimensional Vortex free flow. In the diagram exhibits part the circle to explain the stream lines and potential lines.

The fundamental aspect of the potential flow is that this flow must be irrotational flow. The gradient of the potential in cylindrical coordinates is

$$\mathbf{U} = \nabla\phi = \frac{\partial\phi}{\partial r} \hat{\mathbf{r}} + \frac{1}{r} \frac{\partial\phi}{\partial\theta} \hat{\boldsymbol{\theta}} \tag{10.93}$$

Hence, equation (10.93) dictates that

$$\begin{aligned} \frac{1}{r} \frac{\partial\phi}{\partial\theta} &= f(r) \\ \frac{\partial\phi}{\partial r} &= 0 \end{aligned} \tag{10.94}$$

From these equations it can be seen that

$$\phi = \phi(\theta) \quad (10.95)$$

and

$$\frac{\partial \phi}{\partial \theta} = r f(r) \quad (10.96)$$

Equation (10.96) states that the potential function depends on the angle,  $\theta$  while it also a function of the radius. The only what the above requirement is obtained when the derivative of  $\phi$  and the equation are equal to a constant. Thus,

$$r f(r) = c \implies f(r) = \frac{c}{r} \quad (10.97)$$

$$\frac{\partial \phi}{\partial \theta} = c \implies \phi - \phi_0 = c_1 (\theta - \theta_0)$$

It can be observed from equation (10.96) that the velocity varies inversely with the radius. This variation is referred in the literature as the natural vortex as oppose to forced vortex where the velocity varies in any different functionality. It has to be noted that forced vortex flow is not potential flow.

The stream function can be found in the "standard" way as

$$d\psi = \mathbf{U} \cdot \hat{s} dr$$

It can be observed, in this case, from Figure 10.8 that  $\hat{s} = -\hat{\theta}$  hence

$$d\psi = \hat{\theta} \frac{c_1}{r} \cdot (-\hat{\theta}) dr = -c_1 \frac{dr}{r} \quad (10.98)$$

Thus,

$$\psi - \psi_0 = -c_1 \ln \left( \frac{r}{r_0} \right) \quad (10.99)$$

The source point or the origin of the source is a singular point of the stream function and there it cannot be properly defined. Equation (10.97) dictates that velocity at the origin is infinity. This is similar to natural situations such as tornadoes, hurricanes, and whirlpools where the velocity approaches a very large value near the core. In these situations the pressure becomes very low as the velocity increases. Since the pressure cannot attain a negative value or even approach zero value, the physical situation changes. At the core of these phenomena a relative zone of calm is obtained.

### The Circulation Concept

In the construction of the potential flow or the inviscid flow researchers discover an important concept of circulation. This term is mathematically defined as a closed path



integral around area (in two dimensional flow) of the velocity along the path. The circulation is denoted as  $\Gamma$  and defined as

$$\Gamma = \oint \mathbf{U}_s ds \tag{10.100}$$

Where the velocity  $\mathbf{U}_s$  represents the velocity component in the direction of the path. The symbol  $\oint$  indicating that the integral is over a close path.

Mathematically to obtain the integral the velocity component in the direction of the path has to be chosen and it can be defined as

$$\Gamma = \oint_C \mathbf{U} \cdot \widehat{\mathbf{ds}} \tag{10.101}$$

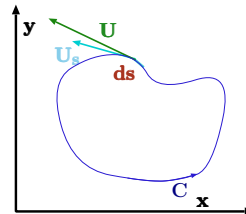

Fig. -10.9. Circulation path to illustrate various calculations.

Substituting the definition potential function into equation (10.101) provides

$$\Gamma = \oint_C \nabla\phi \cdot \widehat{\mathbf{ds}} \tag{10.102}$$

And using some mathematical manipulations yields

$$\Gamma = \oint_C \underbrace{\nabla\phi \cdot \widehat{\mathbf{s}}}_{\frac{d\phi}{ds}} ds = \oint_C d\phi \tag{10.103}$$

The integration of equation (10.103) results in

$$\Gamma = \int_C d\phi = \phi_2(\text{starting point}) - \phi_1(\text{starting point}) \tag{10.104}$$

Unless the potential function is dual or multi value, the difference between the two points is zero. In fact this what is expected from the close path integral. However, in a free vortex situation the situation is different. The integral in that case is the integral around a circular path which is

$$\Gamma = \oint \mathbf{U} \cdot \widehat{\mathbf{ds}} = \oint \frac{c_1}{r} r d\theta = c_1 2\pi \tag{10.105}$$

In this case the circulation,  $\Gamma$  is not vanishing. In this example, the potential function  $\phi$  is a multiple value as potential function the potential function with a single value.

**Example 10.5:**

Calculate the circulation of the source on the path of the circle around the origin with radius  $a$  for a source of a given strength.

SOLUTION

The circulation can be carried by the integration

$$\Gamma = \oint \overbrace{\mathbf{U} \cdot \mathbf{i}}^{=0} r d\theta ds = 0 \quad (10.V.a)$$

Since the velocity is perpendicular to the path at every point on the path, the integral identically is zero.

---

End Solution

---

Thus, there are two kinds of potential functions one where there are single value and those with multi value. The free vortex is the cases where the circulation add the value of the potential function every rotation. Hence, it can be concluded that the potential function of vortex is multi value which increases by the same amount every time,  $c_1 2\pi$ . In this case value at  $\theta = 0$  is different because the potential function did not circulate or encompass a singular point. In the other cases, every additional enclosing adds to the value of potential function a value.

*It was found that the circulation,  $\Gamma$  is zero when there is no singular point within the region inside the path.*

For the free vortex the integration constant can be found if the circulation is known as

$$c_1 = \frac{\Gamma}{2\pi} \quad (10.106)$$

In the literature, the term  $\Gamma$  is, some times, referred to as the “strength” of the vortex. The common form of the stream function and potential function is in the form of

$$\phi = \frac{\Gamma}{2\pi} (\theta - \theta_0) + \phi_0 \quad (10.107a)$$

$$\psi = \frac{\Gamma}{2\pi} \ln\left(\frac{r}{r_0}\right) + \psi_0 \quad (10.107b)$$

**Superposition of Flows**

For incompressible flow and two dimensional the continuity equation reads

$$\nabla \cdot \mathbf{U} = \nabla \cdot \nabla \phi = \nabla^2 \phi = \frac{\partial^2 \phi}{\partial x^2} + \frac{\partial^2 \phi}{\partial y^2} = 0 \quad (10.108)$$

The potential function must satisfy the Laplace’s equation which is a linear partial differential equation. The velocity perpendicular to a solid boundary must be zero

(boundary must be solid) and hence it dictates the boundary conditions on the potential equation. From mathematical point of view this boundary condition as

$$\mathbf{U}_n = \frac{d\phi}{dn} = \nabla\phi \cdot \hat{\mathbf{n}} = 0 \quad (10.109)$$

In this case,  $\hat{\mathbf{n}}$  represents the unit vector normal to the surface.

A solution to certain boundary condition with certain configuration geometry and shape is a velocity flow field which can be described by the potential function,  $\phi$ . If such function exist it can be denoted as  $\phi_1$ . If another velocity flow field exists which describes, or is, the solutions to a different boundary condition(s) it is denoted as  $\phi_2$ . The Laplacian of first potential is zero,  $\nabla^2\phi_1 = 0$  and the same is true for the second one  $\nabla^2\phi_2 = 0$ . Hence, it can be written that

$$\overbrace{\nabla^2\phi_1}^{=0} + \overbrace{\nabla^2\phi_2}^{=0} = 0 \quad (10.110)$$

Since the Laplace mathematical operator is linear the two potential can be combined as

$$\nabla^2(\phi_1 + \phi_2) = 0 \quad (10.111)$$

The boundary conditions can be also treated in the same fashion. On a solid boundary condition for both functions is zero hence

$$\frac{d\phi_1}{dn} = \frac{d\phi_2}{dn} = 0 \quad (10.112)$$

and the normal derivative is linear operator and thus

$$\frac{d(\phi_1 + \phi_2)}{dn} = 0 \quad (10.113)$$

It can be observed that the combined new potential function create a new velocity field. In fact it can be written that

$$\mathbf{U} = \nabla(\phi_1 + \phi_2) = \nabla\phi_1 + \nabla\phi_2 = \mathbf{U}_1 + \mathbf{U}_2 \quad (10.114)$$

The velocities  $\mathbf{U}_1$  and  $\mathbf{U}_2$  are obtained from  $\phi_1$  and  $\phi_2$  respectively. Hence, the superposition of the solutions is the characteristic of the potential flow.

### Source and Sink Flow or Doublet Flow

In the potential flow, there is a special case where the source and sink are combined since it represents a special and useful shape. A source is located at point B which is  $r_0$  from the origin on the positive  $x$  coordinate. The flow rate from the source is  $Q_0$  and the potential function is

$$Q_1 = \frac{Q_0}{2\pi} \ln\left(\frac{r_B}{r_0}\right) \quad (10.115)$$

The sink is at the same distance but at the negative side of the  $x$  coordinate and hence it can be represented by the potential function

$$Q_1 = -\frac{Q_0}{2\pi} \ln\left(\frac{r_A}{r_0}\right) \quad (10.116)$$

The description is depicted on Figure 10.10. The distances,  $r_A$  and  $r_B$  are defined from the points  $A$  and  $B$  respectively. The potential of the source and the sink is

$$\phi = \frac{Q_0}{2\pi} (\ln r_A - \ln r_B) \quad (10.117)$$

In this case, it is more convenient to represent the situation utilizing the cylindrical coordinates. The Law of Cosines for the right triangle ( $OBR$ ) this cases reads

$$r_B^2 = r^2 + r_0^2 - 2r r_0 \cos\theta \quad (10.118)$$

In the same manner it applied to the left triangle as

$$r_A^2 = r^2 + r_0^2 + 2r r_0 \cos\theta \quad (10.119)$$

Therefore, equation (10.117) can be written as

$$\phi = -\frac{Q_0}{2\pi} \frac{1}{2} \ln \left( \frac{\frac{r^2 + r_0^2}{2r r_0 \cos\theta} + 1}{\frac{r^2 + r_0^2}{2r r_0 \cos\theta} - 1} \right) \quad (10.120)$$

It can be shown that the following the identity exist

— — — — *Caution: mathematical details which can be skipped* — — — —

$$\coth^{-1}(\xi) = \frac{1}{2} \ln \left( \frac{\xi + 1}{\xi - 1} \right) \quad (10.121)$$

where  $\xi$  is a dummy variable. Hence, substituting into equation (10.120) the identity of equation (10.121) results in

$$\phi = -\frac{Q_0}{2\pi} \coth^{-1} \left( \frac{r^2 + r_0^2}{2r r_0 \cos\theta} \right) \quad (10.122)$$

The several following stages are more of a mathematical nature which provide minimal contribution to physical understanding but are provide to interested reader. The manipulations are easier with an implicit solution and thus

$$\coth \left( -\frac{2\pi\phi}{Q} \right) = \frac{r^2 + r_0^2}{2r r_0 \cos\theta} \quad (10.123)$$

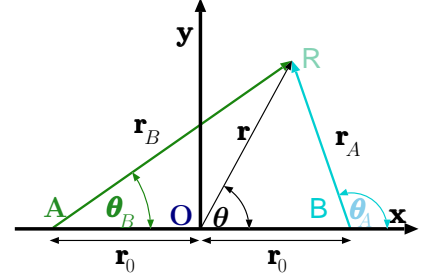

Fig. -10.10. Combination of the Source and Sink located at a distance  $r_0$  from the origin on the  $x$  coordinate. The source is on the right.

Equation (10.123), when noticing that the  $\cos \theta \coth(-x) = -\coth(x)$ , can be written as

$$-2 r_0 r \cos \theta \coth \left( \frac{2 \pi \phi}{Q} \right) = r^2 + r_0^2 \tag{10.124}$$

In Cartesian coordinates equation (10.124) can be written as

$$-2 r_0 \overbrace{x}^{r \cos \theta} \coth \left( -\frac{2 \pi \phi}{Q} \right) = x^2 + y^2 + r_0^2 \tag{10.125}$$

Equation (10.125) can be rearranged by the left hand side to right as and moving  $r_0^2$  to left side result in

$$-r_0^2 = 2 r_0 \overbrace{x}^{r \cos \theta} \coth \left( \frac{2 \pi \phi}{Q} \right) + x^2 + y^2 \tag{10.126}$$

Add to both sides  $r_0^2 \coth^2 \frac{2 \pi \phi}{Q_0}$  transfers equation (10.126)

$$r_0^2 \coth^2 \frac{2 \pi \phi}{Q_0} - r_0^2 = r_0^2 \coth^2 \frac{2 \pi \phi}{Q_0} + 2 r_0 \overbrace{x}^{r \cos \theta} \coth \left( \frac{2 \pi \phi}{Q} \right) + x^2 + y^2 \tag{10.127}$$

The hyperbolic identity<sup>6</sup> can be written as

$$r_0^2 \operatorname{csch}^2 \frac{2 \pi \phi}{Q_0} = r_0^2 \coth^2 \frac{2 \pi \phi}{Q_0} + 2 r_0 \overbrace{x}^{r \cos \theta} \coth \left( \frac{2 \pi \phi}{Q} \right) + x^2 + y^2 \tag{10.128}$$

— — — — — *End Caution: mathematical details* — — — — —

It can be noticed that first three term on the right hand side are actually quadratic and can be written as

$$r_0^2 \operatorname{csch}^2 \frac{2 \pi \phi}{Q_0} = \left( r_0 \coth \frac{2 \pi \phi}{Q_0} + x \right)^2 + y^2 \tag{10.129}$$

equation (10.129) represents a circle with a radius  $r_0 \operatorname{csch} \frac{2 \pi \phi}{Q_0}$  and a center at  $\pm r_0 \coth \left( \frac{2 \pi \phi}{Q_0} \right)$ .

The potential lines depicted on Figure 10.11.

For the drawing purposes equation (10.129) is transformed into a dimensionless form as

$$\left( \coth \frac{2 \pi \phi}{Q_0} + \frac{x}{r_0} \right)^2 + \left( \frac{y}{r_0} \right)^2 = \operatorname{csch}^2 \frac{2 \pi \phi}{Q_0} \tag{10.130}$$

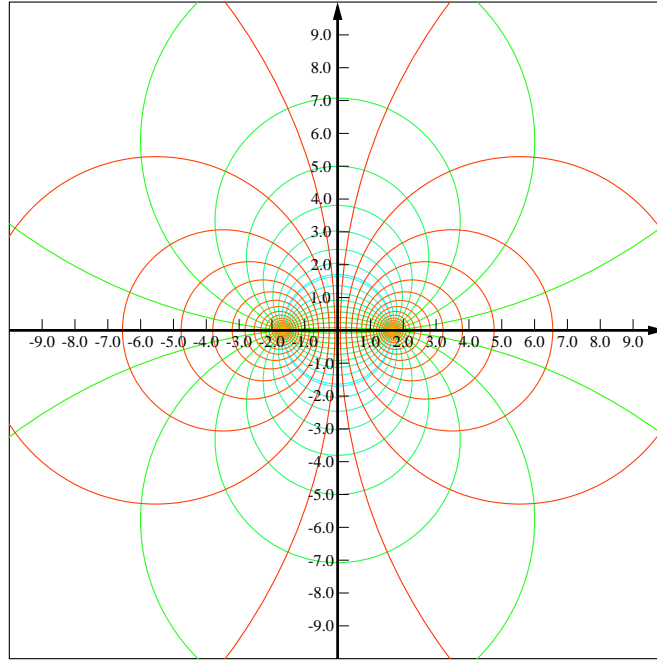

Fig. -10.11. Stream and Potential line for a source and sink. It can be noticed that stream line (in blue to green) and the potential line are in orange to crimson. This figure is relative distances of  $x/r_0$  and  $y/r_0$ . The parameter that change is  $2\pi\phi/Q_0$  and  $2\pi\psi/Q_0$ . Notice that for give larger of  $\phi$  the circles are smaller.

Notice that the stream function has the same dimensions as the source/sink flow rate.

The stream lines can be obtained by utilizing similar procedure. The double stream function is made from the combination of the source and sink because stream functions can be added up. Hence,

$$\psi = \psi_1 + \psi_2 = \frac{Q_0}{2\pi} (\theta_1 - \theta_2) \quad (10.131)$$

The angle  $\theta_1$  and  $\theta_2$  shown in Figure 10.11 related other geometrical parameters as

$$\theta_1 = \tan^{-1} \frac{y}{x - r_0} \quad (10.132)$$

$\coth^2(x) - 1 = \frac{\cosh^2(x)}{\sinh^2(x)} - 1 = \frac{\cosh^2(x) - \sinh^2(x)}{\sinh^2(x)}$  and since by the definitions  $\cosh^2(x) - \sinh^2(x) = 1$  the identity is proved.

and

$$\theta_2 = \tan^{-1} \frac{y}{x + r_0} \quad (10.133)$$

The stream function becomes

$$\psi = \frac{Q_0}{2\pi} \left( \tan^{-1} \frac{y}{x - r_0} - \tan^{-1} \frac{y}{x + r_0} \right) \quad (10.134)$$

*Caution: mathematical details which can be skipped*

Rearranging equation (10.134) yields

$$\frac{2\pi\psi}{Q_0} = \tan^{-1} \frac{y}{x - r_0} - \tan^{-1} \frac{y}{x + r_0} \quad (10.135)$$

Utilizing the identity  $\tan^{-1} u + \tan^{-1} v = \tan^{-1} \left( \frac{u+v}{1-uv} \right)$ <sup>7</sup> Equation (10.135) transfers to

$$\tan \frac{2\pi\psi}{Q_0} = \frac{\frac{y}{x - r_0} - \frac{y}{x + r_0}}{1 + \frac{y^2}{x^2 - r_0^2}} \quad (10.136)$$

As in the potential function cases, Several manipulations to convert the equation (10.136) form so it can be represented in a "standard" geometrical shapes are done before to potential function. Reversing and finding the common denominator provide

$$\cot \frac{2\pi\psi}{Q_0} = \frac{\frac{x^2 - r_0^2 + y^2}{x^2 - r_0^2}}{\frac{y(x + r_0) - y(x - r_0)}{x^2 - r_0^2}} = \frac{x^2 - r_0^2 + y^2}{\underbrace{y(x + r_0) + y(x - r_0)}_{2yr_0}} \quad (10.137)$$

or

$$x^2 + y^2 - r_0^2 = 2r_0 y \cot \frac{2\pi\psi}{Q_0} \quad (10.138)$$

*End Caution: mathematical details*

Equation (10.138) can be rearranged, into a typical circular representation as

$$x^2 + \left( y - r_0 \cot \frac{2\pi\psi}{Q_0} \right)^2 = \left( r_0 \csc \frac{2\pi\psi}{Q_0} \right)^2 \quad (10.139)$$

<sup>7</sup>This identity is derived from the geometrical identity of  $\tan(\alpha + \beta) = \frac{\tan \alpha + \tan \beta}{1 - \tan \alpha \tan \beta}$  by simple defining that  $u = \tan^{-1} \alpha$  and  $v = \tan^{-1} \beta$ .

Equation (10.139) describes circles with center on the  $y$  coordinates at  $y = r_0 \cot \frac{2\pi\psi}{Q_0}$ . It can be noticed that these circles are orthogonal to the circle that represents the potential lines. For the drawing it is convenient to write equation (10.139) in dimensionless form as

$$\left(\frac{x}{r_0}\right)^2 + \left(\frac{y}{r_0} - \cot \frac{2\pi\psi}{Q_0}\right)^2 = \left(\csc \frac{2\pi\psi}{Q_0}\right)^2 \quad (10.140)$$

### Dipole Flow

It was found that when the distance between the sink and source shrinks to zero a new possibility is created which provides benefits to new understanding. The new combination is referred to as the dipole. Even though, the construction of source/sink to a single location (as the radius is reduced to zero) the new "creature" has direction as opposed to the scalar characteristics of source and sink. First the potential function and stream function will be presented. The potential function is

$$\lim_{r_0 \rightarrow 0} \phi = -\frac{Q_0}{2\pi} \frac{1}{2} \ln \left( \frac{r^2 + r_0^2 - 2r r_0 \cos \theta}{r^2 + r_0^2 + 2r r_0 \cos \theta} \right) \quad (10.141)$$

To determine the value of the quantity in equation (10.141) the L'Hopital's rule will be used. First the appropriate form will be derived so the technique can be used.

— *Caution: mathematical details which can be skipped* —

Multiplying and dividing equation (10.141) by  $2r_0$  yields

$$\lim_{r_0 \rightarrow 0} \phi = \underbrace{\frac{Q_0 2r_0}{2\pi}}_{1^{st} \text{ part}} \underbrace{\frac{1}{2r_0} \ln \left( \frac{r^2 + r_0^2 - 2r r_0 \cos \theta}{r^2 + r_0^2 + 2r r_0 \cos \theta} \right)}_{2^{nd} \text{ part}} \quad (10.142)$$

Equation (10.142) has two parts. The first part,  $(Q_0 2r_0)/2\pi$ , which is a function of  $Q_0$  and  $r_0$  and the second part which is a function of  $r_0$ . While reducing  $r_0$  to zero, the flow increases in such way that the combination of  $Q_0 r_0$  is constant. Hence, the second part has to be examined and arranged for this purpose.

$$\lim_{r_0 \rightarrow 0} \frac{\ln \left( \frac{r^2 + r_0^2 - 2r r_0 \cos \theta}{r^2 + r_0^2 + 2r r_0 \cos \theta} \right)}{4r_0} \quad (10.143)$$

It can be noticed that the ratio in the natural logarithm approach one  $r_0 \rightarrow 0$ . The L'Hopital's rule can be applied because the situation of nature of  $0/0$ . The numerator can be found using a short cut<sup>8</sup>

<sup>8</sup> In general the derivative  $\ln \frac{f(\xi)}{g(\xi)}$  is done by derivative of the natural logarithm with fraction inside. The general form of this derivative is

$$\frac{d}{d\xi} \ln \frac{f(\xi)}{g(\xi)} = \frac{g(\xi)}{f(\xi)} \frac{d}{d\xi} \left( \frac{f(\xi)}{g(\xi)} \right)$$



— — — — — *End Caution: mathematical details* — — — — —

at

$$\lim_{r_0 \rightarrow 0} \frac{\frac{2r_0^0 - 2r \cos \theta}{r^2 + r_0^2 - 2r r_0 \cos \theta} - \frac{2r_0^0 + 2r \cos \theta}{r^2 + r_0^2 + 2r r_0 \cos \theta}}{4} = -\frac{\cos \theta}{r} \quad (10.144)$$

Combining the first and part with the second part results in

$$\phi = -\frac{Q_0 r_0 \cos \theta}{\pi r} \quad (10.145)$$

After the potential function was established the attention can be turned into the stream function. To establish the stream function, the continuity equation in cylindrical is used which is

$$\nabla \cdot \mathbf{U} = \frac{1}{r} \left( \frac{\partial r U_r}{\partial r} + \frac{\partial U_\theta}{\partial \theta} \right)$$

The transformation of equations (10.46) and (10.48) to cylindrical coordinates results in

$$U_r = \frac{1}{r} \frac{\partial \psi}{\partial \theta} \quad (10.146a)$$

$$U_\theta = -\frac{\partial \psi}{\partial r} \quad (10.146b)$$

The relationship for the potential function of the cylindrical coordinates was determined before an appear the relationship (10.66) and (10.67) in cylindrical coordinates to be

$$U_r = \frac{\partial \phi}{\partial r} \quad \text{and} \quad (10.147a)$$

The internal derivative is done by the quotient rule and using the prime notation as

$$\left( \ln \frac{f(\xi)}{g(\xi)} \right)' = \frac{g(\xi)}{f(\xi)} \left( \frac{f(\xi)(g(\xi))' - g(\xi)(f(\xi))'}{(g(\xi))^2} \right)$$

by canceling the various parts (notice the color coding). First canceling the square (the red color) and breaking to two fractions and in the first one canceling the numerator (green color) second one canceling the denominator (cyan color), one can obtain

$$\left( \ln \frac{f(\xi)}{g(\xi)} \right)' = \frac{\cancel{g(\xi)}}{\cancel{f(\xi)}} \left( \frac{\cancel{f(\xi)}(g(\xi))' - \cancel{g(\xi)}(f(\xi))'}{\cancel{(g(\xi))^2}} \right) = \frac{(g(\xi))'}{g(\xi)} - \frac{(f(\xi))'}{f(\xi)}$$

$$U_\theta = \frac{1}{r} \frac{\partial \phi}{\partial \theta} \quad (10.147b)$$

Thus the relationships that were obtained before for Cartesian coordinates is written in cylindrical coordinates as

$$\frac{\partial \phi}{\partial r} = \frac{1}{r} \frac{\partial \psi}{\partial \theta} \quad (10.148a)$$

$$\frac{1}{r} \frac{\partial \phi}{\partial \theta} = - \frac{\partial \psi}{\partial r} \quad (10.148b)$$

In the case of the dipole, the knowledge of the potential function is used to obtain the stream function. The derivative of the potential function as respect to the radius is

$$\frac{\partial \phi}{\partial r} = \frac{Q_0}{2\pi} \frac{\cos \theta}{r^2} \frac{1}{r} \frac{\partial \psi}{\partial \theta} \quad (10.149)$$

And

$$\frac{1}{r} \frac{\partial \phi}{\partial \theta} = \frac{Q_0}{2\pi} \frac{\sin \theta}{r^2} - \frac{\partial \psi}{\partial r} \quad (10.150)$$

From equation (10.149) after integration with respect to  $\theta$  one can obtain

$$\psi = \frac{Q_0}{2\pi r} \sin \theta + f(r) \quad (10.151)$$

and from equation (10.150) one can obtain that

$$- \frac{\partial \psi}{\partial r} = \frac{Q_0}{2\pi r^2} \sin \theta + f'(r) \quad (10.152)$$

The only way that these conditions co-exist is  $f(r)$  to be constant and thus  $f'(r)$  is zero. The general solution of the stream function is then

$$\psi = \frac{Q_0 \sin \theta}{2\pi r} \quad (10.153)$$

— — — — — *Caution: mathematical details which can be skipped* — — — — —

The potential function and stream function describe the circles as following: In equation (10.153) it can be recognized that  $r = \sqrt{x^2 + y^2}$ . Thus, multiply equation (10.153) by  $r$  and some rearrangement yield

$$\frac{2\pi \psi}{Q_0} \left( \overbrace{x^2 + y^2}^{r^2} \right) = \overbrace{r \sin \theta}^y \quad (10.154)$$

Further rearranging equation (10.154) provides

$$\left( \overbrace{x^2 + y^2}^{r^2} \right) = \frac{Q_0}{2\pi\psi} \overbrace{y}^{r \sin \theta} - \overbrace{\left( \frac{Q_0}{2\pi\psi} \right)^2 + \left( \frac{Q_0}{2\pi\psi} \right)^2}^{=0} \quad (10.155)$$

and converting to the standard equation of circles as

$$\overbrace{y^2 - \frac{Q_0}{2\pi\psi} y + \left( \frac{Q_0}{2\pi\psi} \right)^2}^{y - \frac{Q_0}{2\pi\psi}} + x^2 = \left( \frac{Q_0}{2\pi\psi} \right)^2 \quad (10.156)$$

— — — — — *End Caution: mathematical details* — — — — —

The equation (10.153) (or (10.156)) represents a circle with a radius of  $\frac{Q_0}{2\pi\psi}$  with location at  $x = 0$  and  $y = \pm \frac{Q_0}{2\pi\psi}$ . The identical derivations can be done for the potential function. It can be noticed that the difference between the functions results from difference of  $r \sin \theta$  the instead of the term is  $r \cos \theta$ . Thus, the potential functions are made from circles that the centers are at same distance as their radius from origin on the  $x$  coordinate. It can be noticed that the stream function and the potential function can have positive and negative values and hence there are family on both sides of coordinates. Figure 10.12 displays the stream functions (cyan to green color) and potential functions (gold to crimson color). Notice the larger the value of the stream function the smaller the circle and the same for the potential functions.

It must be noted that in the derivations above it was assumed that the sink is on the left and source is on the right. Clear similar results will obtained if the sink and source were oriented differently. Hence the dipole (even though) potential and stream functions are scalar functions have a direction. In this stage this topic will not be treated but must be kept in question form.

**Example 10.6:**

*This academic example is provided mostly for practice of the mathematics. Built the stream function of dipole with angle. Start with a source and a sink distance  $r$  from origin on the line with a angle  $\beta$  from  $x$  coordinates. Let the distance shrink to zero. Write the stream function.*

### 10.3.1 Flow Around a Circular Cylinder

After several elements of the potential flow were built earlier, the first use of these elements can be demonstrated. Perhaps the most celebrated and useful example is the flow past a cylinder which this section will be dealing with. The stream function made by superimposing a uniform flow and a doublet is

$$\psi = U_0 y + \frac{Q_0 \sin \theta}{2\pi r} = U_0 r \sin \theta + \frac{Q_0 r \sin \theta}{2\pi r^2} \quad (10.157)$$

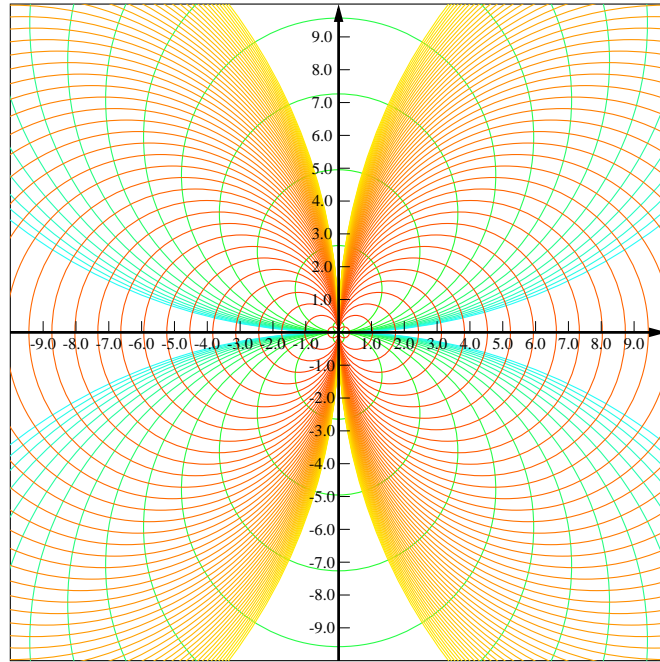

Fig. -10.12. Stream lines and Potential lines for Doublet. The potential lines are in gold color to crimson while the stream lines are cyan to green color. Notice the smaller value of the stream function translates the smaller circle. The drawing were made for the constant to be one (1) and direct value can be obtained by simply multiplying.

Or after some arrangement equation (10.157) becomes

$$\psi = U_0 r \sin \theta \left( 1 + \frac{Q_0}{2U_0 \pi r^2} \right) \quad (10.158)$$

Denoting  $\frac{Q_0}{2U_0 \pi}$  as  $-a^2$  transforms equation (10.158) to

$$\psi = U_0 r \sin \theta \left( 1 - \frac{a^2}{r^2} \right) \quad (10.159)$$

The stream function for  $\psi = 0$  is

$$0 = U_0 r \sin \theta \left( 1 - \frac{a^2}{r^2} \right) \quad (10.160)$$

This value is obtained when  $\theta = 0$  or  $\theta = \pi$  and/or  $r = a$ . The stream line that is defined by radius  $r = a$  describes a circle with a radius  $a$  with a center in the origin.

The other two lines are the horizontal coordinates. The flow does not cross any stream line, hence the stream line represented by  $r = a$  can represent a cylindrical solid body.

For the case where  $\psi \neq 0$  the stream function can be any value. Multiplying equation (10.159) by  $r$  and dividing by  $U_0 a^2$  and some rearranging yields

$$\frac{r}{a} \frac{\psi}{a U_0} = \left(\frac{r}{a}\right)^2 \sin \theta - \sin \theta \quad (10.161)$$

It is convenient, to go through the regular dimensionalizing process as

$$\bar{r} \bar{\psi} = (\bar{r})^2 \sin \theta - \sin \theta \quad \text{or} \quad \bar{r}^2 - \frac{\bar{\psi}}{\sin \theta} \bar{r} - 1 = 0 \quad (10.162)$$

The radius for other streamlines can found or calculated for a given angle and given value of the stream function. The radius is given by

$$\bar{r} = \frac{\frac{\bar{\psi}}{\sin \theta} \pm \sqrt{\left(\frac{\bar{\psi}}{\sin \theta}\right)^2 + 4}}{2} \quad (10.163)$$

It can be observed that the plus sign must be used for radius with positive values (there are no physical radii which negative absolute value). The various value of the stream function can be chosen and drawn. For example, choosing the value of the stream function as multiply of  $\bar{\psi} = 2n$  (where  $n$  can be any real number) results in

$$\bar{r} = \frac{\frac{2n}{\sin \theta} \pm \sqrt{\left(\frac{2n}{\sin \theta}\right)^2 + 4}}{2} = n \csc(\theta) + \sqrt{n^2 \csc^2(\theta) + 1} \quad (10.164)$$

The various values for of the stream function are represented by the ratios  $n$ . For example for  $n = 1$  the (actual) radius as a function the angle can be written as

$$r = a \left( \csc(\theta) + \sqrt{\csc^2(\theta) + 1} \right) \quad (10.165)$$

The value  $\csc(\theta)$  for  $\theta = 0$  and  $\theta = \pi$  is equal to infinity ( $\infty$ ) and for values of  $\csc(\theta = \pi/2) = 1$ . Similar every line can be evaluated. The lines are drawn in Figure 10.13.

The velocity of this flow field can be found by using the equations that were developed so far. The radial velocity is

$$U_r = \frac{1}{r} \frac{\partial \psi}{\partial \theta} = U_0 \cos \theta \left( 1 - \frac{a^2}{r^2} \right) \quad (10.166)$$

The tangential velocity is

$$U_\theta = -\frac{\partial \psi}{\partial r} = U_0 \sin \theta \left( 1 + \frac{a^2}{r^2} \right) \quad (10.167)$$

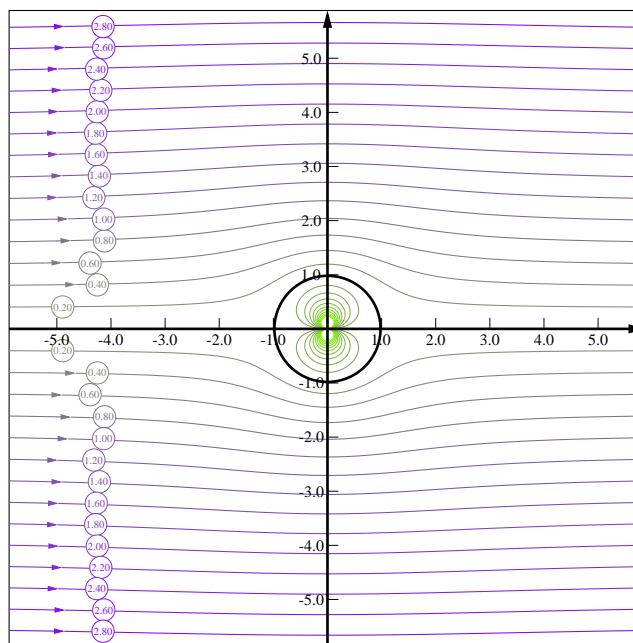

Fig. -10.13. Stream function of uniform flow plus doublet results in solid body with flow around it. Stream function ( $n$  and not  $\psi$ ) starts from -2.0 (green line) to 3 the (purple line). The negative streamlines lines are inside the solid body. The arrows are calculated by trapping the  $y$  for given  $\psi$  around the end points. Hence, the slight difference between the arrow and the line. The more negative the stream function the smaller the counter. The larger positive stream function the further away the line form the  $x$  coordinate. It can be noticed closer the "solid body" the lines are more curved. The GLE code is attached in the source code to this book. The value of  $n$  is the bubbles.

#### Example 10.7:

A sink is placed in a uniform flow field from the left to right. Describe flow field by the stream lines. Find the shape of the solid body described by this flow.

#### SOLUTION

The stream function for uniform flow is given by equation (10.80b) and the stream by equation (10.90) (with positive sign because it is source). Hence the stream function is

$$\psi = U_0 r \sin \theta + \frac{\dot{Q}}{2\pi} \theta \quad (10.VII.a)$$

For  $\psi = 0$  equation (10.VII.a) becomes

$$r = -\frac{\dot{Q}\theta}{2\pi U_0 \sin\theta} \tag{10.VII.b}$$

or in for any value of stream function,  $\psi$  as

$$r = \frac{\psi}{U_0 \sin\theta} - \frac{\dot{Q}\theta}{2\pi U_0 \sin\theta} \tag{10.VII.c}$$

The long cigar shape resulted from the combination of the uniform flow with the source is presented in Figure 10.14. The black line represents the solid body that created and show two different kind of flows. The exterior and the interior flow represent the external flow outside and the inside the black line represents the flow on the enclosed body.

The black line divides the streamline, which separates the fluid coming from the uniform source the flow due to the inside source. Thus, these flows represent a flow around semi-infinite solid body and flow from a source in enclosed body.

The width of the body at infinity for incompressible flow can be determined by the condition that the flow rate must be the same. The velocity can be obtained from the stream function.

Substituting into (10.VII.b) as

$$\underbrace{r \sin\theta}_y = -\frac{\dot{Q}\theta}{2\pi U_0} \tag{10.VII.d}$$

An noticing that at  $\theta = \pi$  is on the right hand side (opposite to your the intuition) of the solid body (or infinity). Hence equation (10.VII.d) can be written as

$$y = \frac{\dot{Q}\pi}{2\pi U_0} = \frac{\dot{Q}}{2U_0} \tag{10.VII.e}$$

It can be noticed that sign in front of  $y$  is accounted for and thus removed from the equation. To check if this analysis is consistent with the continuity equation, the velocity at infinity must be  $U = U_0$  because the velocity due to the source is reduced as  $\sim 1/r$ . Hence, the source flow rate must be balanced (see for the integral mass conservation) flow rate at infinity hence

$$Q = U_0 2y = U_0 2 \frac{Q_0}{2U_0} = Q_0 \tag{10.VII.f}$$

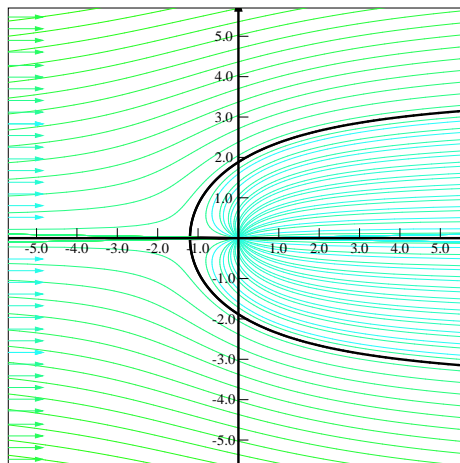

Fig. -10.14. Source in the Uniform Flow.

The stagnation point can be seen from Figure 10.14 by ascertaining the location where the velocity is zero. Due to the symmetry the location is on “solid” body on the  $x$ -coordinate at some distance from the origin. This distance can be found by looking the combined velocities as

$$U_0 = \frac{Q_0}{2\pi r} \implies r = \frac{Q_0}{2\pi U_0} \quad (10.VII.g)$$

---

End Solution

---

### Pressure Distribution

One advantage of the inviscid flow approach is the ability to have good estimates of the pressure and velocity distribution. These two (pressure and velocity distribution) are related via the Bernoulli's equation. The explanation and use is based on a specific example and for a specific information.

To illustrate this point the velocity distribution consider a doublet in uniform flow which was examined earlier. The velocity field is a function of  $x, y$  and hence to answer questions such as the location where the highest velocity or the highest velocity itself is required to find the maximum point. This operation is a standard operation in mathematics. However, in this case the observation of Figure 10.13 suggests that the height velocity is at the the line of the  $y$ -coordinate. The fundamental reason for the above conclusion is that the area symmetry around  $y$  coordinate and the fact that cross area shrink.

The radial velocity is zero on the  $y$ -coordinate (due the symmetry and similar arguments) is zero. The tangential velocity on the “solid” body is

$$U_\theta = -2U_0 \sin \theta \quad (10.168)$$

The maximum velocity occurs at

$$\frac{dU_\theta}{d\theta} = -2U_0 \cos \theta = 0 \quad (10.169)$$

The angle  $\pi/2$  and  $3\pi/2$  are satisfying equation (10.169). The velocity as function of the radius is

$$U_\theta = \pm U_0 \left( 1 + \frac{a^2}{r^2} \right) \quad (10.170)$$

Where the negative sign is for  $\theta = \pi/2$  and the positive sign for  $\theta = 3\pi/2$ . That is the velocity on surface of the “solid body” is the highest. The velocity profile at specific angles is presented in Figure (10.15).

Beside the velocity field, the pressure distribution is a common knowledge needed for many engineering tasks. The Euler number is a dimensionless number representing

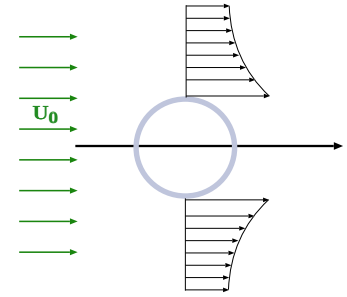

Fig. -10.15. Velocity field around a doublet in uniform velocity.



the pressure and is defined as

$$Eu = \frac{P_0 - P_\infty}{\frac{1}{2} \rho U_0^2} \quad (10.171)$$

In inviscid flow (Euler's equations) as a sub set of Naiver–Stokes equations the energy conserved hence (see for discussion on Bernoulli equation),

$$P_0 = P + \frac{1}{2} \rho U^2 \quad \text{or} \quad P_0 - P = \frac{1}{2} \rho U^2 \quad (10.172)$$

Dividing equation (10.172) by  $U_0^2$  yields

$$\frac{P_0 - P}{U_0^2} = \frac{1}{2} \rho \frac{U^2}{U_0^2} \implies \frac{P_0 - P}{\frac{1}{2} \rho U_0^2} = \frac{U^2}{U_0^2} \quad (10.173)$$

The velocity on the surface of the "solid" body is given by equation (10.168) Hence,

$$\frac{P_0 - P}{\frac{1}{2} \rho U_0^2} = 4 \sin^2 \theta \quad (10.174)$$

It is interesting to point that integration of the pressure results in no lift and no resistance to the flow. This "surprising" conclusion can be provided by carrying the integration of around the "solid" body and taking the  $x$  or  $y$  component depending if lift or drag is calculated. Additionally, it can be noticed that symmetry plays a major role which one side cancels the other side.

### 10.3.1.1 Adding Circulation to a Cylinder

The cylinder discussed in the previous sections was made from a dipole in a uniform flow field. It was demonstrated that in the potential flow has no resistance, and no lift due to symmetry of the pressure distribution. Thus, it was suggested that by adding an additional component that it would change the symmetry but not change the shape and hence it would provide the representation of a cylinder with lift. It turned out that this idea yields a better understanding of the one primary reason of lift. This result was verified by the experimental evidence.

The linear characteristic (superposition principle) provides by adding the stream function of the free vortex to the previous stream function for the case. The stream function in this case (see equation (10.159)) is

$$\psi = U_0 r \sin \theta \left( 1 - \left( \frac{r}{a} \right)^2 \right) + \frac{\Gamma}{2\pi} \ln \frac{a}{r} \quad (10.175)$$

It can be noticed that this stream function (10.175) on the body is equal to  $\psi(r = a) = 0$ . Hence, the shape of the body remains a circle. The corresponding radial velocity in cylindrical coordinates (unchanged) and is

$$U_r = \frac{1}{r} \frac{\partial \psi}{\partial \theta} = U_0 \cos \theta \left( 1 - \left( \frac{a}{r} \right)^2 \right) \quad (10.176)$$

The tangential velocity is changed (add velocity at the top and reduce velocity at the bottom or vice versa depending of the sign of the  $\Gamma$ ) to be

$$U_\theta = -\frac{\partial\psi}{\partial r} = U_0 \sin\theta \left(1 + \left(\frac{a}{r}\right)^2\right) + \frac{\Gamma}{2\pi r} \quad (10.177)$$

As it was stated before, examination of the stream function  $\psi = 0$  is constructed. As it was constructed and discussed earlier it was observed that the location of stagnation stream function is on  $r = a$ . On this line, equation (10.175) can be written as

$$0 = U_0 r \sin\theta \left(1 - \left(\frac{a}{r}\right)^2\right) + \frac{\Gamma}{2\pi} \ln \frac{a}{r} \quad (10.178)$$

or

$$\begin{aligned} \sin\theta &= -\frac{\frac{\Gamma}{2\pi} \ln \frac{r}{a}}{U_0 r \left(1 - \left(\frac{a}{r}\right)^2\right)} = \frac{\Gamma}{4\pi U_0} \frac{\frac{2 \ln \frac{a}{r}}{a}}{\frac{r}{a} \left(1 - \left(\frac{a}{r}\right)^2\right)} = \\ &= \frac{\Gamma}{4\pi U_0} \frac{r}{a} \frac{\ln \left(\frac{a}{r}\right)^2}{1 - \left(\frac{a}{r}\right)^2} = \frac{\Gamma}{4\pi U_0} \frac{\ln \left(\frac{1}{\bar{r}}\right)^2}{1 - \left(\frac{1}{\bar{r}}\right)^2} \quad (10.179) \end{aligned}$$

At the point  $r = a$  the ratio in the box is approaching 0/0 and to examine what happen to it L'Hopital's rule can be applied. The examination can be simplified by denoting  $\xi = (a/r)^2 = \bar{r}$  and noticing that  $\xi = 1$  at that point and hence

$$\lim_{\xi \rightarrow 1} \frac{\ln \xi}{1 - \xi} = \lim_{\xi \rightarrow 1} \frac{\frac{1}{\xi}}{-1} = -1 \quad (10.180)$$

Hence, the relationship expressed in equation (10.178) as

$$\sin\theta = \frac{-\Gamma}{4\pi U_0 a} \quad (10.181)$$

This condition (10.181) limits the value of maximum circulation on the body due to the maximum value of sin function. The doublet strength maximum strength can be The condition

$$|\Gamma| \leq 4\pi U_0 a \quad (10.182)$$

The value of doublet strength determines the stagnation points (which were moved by the free vortex so to speak). For example, the stagnation points for the

value  $\Gamma = -2\sqrt{2-\sqrt{3}}\pi U_0 a$  can be evaluated as

$$\sin \theta = \frac{\overbrace{2\sqrt{2-\sqrt{3}}\pi U_0 a}^{-\Gamma}}{4\pi U_0 a} = \frac{\sqrt{2-\sqrt{3}}}{2} \quad (10.183)$$

The solution for equation (theta,  $\theta$ ) (10.183) is  $15^\circ$  or  $\pi/12$  and  $165^\circ$  or  $11\pi/12$ . For various stagnation points can be found in similar way.

The rest of the points of the stagnation stream lines are found from the equation (10.179). For the previous example with specific value of the ratio,  $\bar{\Gamma}$  as

$$\sin \theta = \frac{\sqrt{2-\sqrt{3}}a}{2r} \frac{\ln\left(\frac{a}{r}\right)^2}{1-\left(\frac{a}{r}\right)^2} \quad (10.184)$$

There is a special point where the two points are merging 0 and  $\pi$ .

For all other points stream function can be calculated from equation (10.175) can be written as

$$\frac{\psi}{U_0 a} = \frac{r}{a} \sin \theta \left(1 - \left(\frac{a}{r}\right)^2\right) + \frac{\Gamma}{2\pi U_0 a} \ln \frac{r}{a} \quad (10.185)$$

or in a previous dimensionless form plus multiply by  $\bar{r}$  as

$$\frac{\bar{r}\bar{\psi}}{\sin \theta} = \bar{r}^2 \left(1 - \left(\frac{1}{\bar{r}}\right)^2\right) + \frac{\bar{\Gamma}\bar{r}}{2\pi U_0 a \sin \theta} \ln \bar{r} \quad (10.186)$$

After some rearrangement of moving the left hand side to right and denoting  $\bar{\Gamma} = \frac{\Gamma}{4\pi U_0 a}$  along with the previous definition of  $\bar{\psi} = 2n$  equation (10.186) becomes

$$0 = \bar{r}^2 - \frac{\bar{r}\bar{\psi}}{\sin \theta} - 1 + \frac{2\bar{\Gamma}\bar{r} \ln \bar{r}}{\sin \theta} \quad (10.187)$$

Note the sign in front the last term with the  $\Gamma$  is changed because the ratio in the logarithm is reversed.

The stagnation line occur when  $n = 0$  hence equation (10.187) satisfied for all  $\bar{r} = 1$  regardless to value of the  $\theta$ . However, these are not the only solutions. To obtain the solution equation (stagnation line) (10.187) is rearranged as

$$\theta = \sin^{-1} \left( \frac{2\bar{\Gamma}\bar{r} \ln \bar{r}}{1 - \bar{r}^2} \right) \quad (10.188)$$

Equation (10.187) has three roots (sometime only one) in the most zone and parameters. One roots is in the vicinity of zero. The second roots is around the one

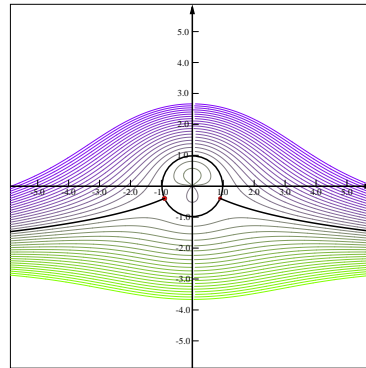

(a) Streamlines of doublet in uniform field with stagnation point on the body.  $\Gamma = 0.2$  for this figure.

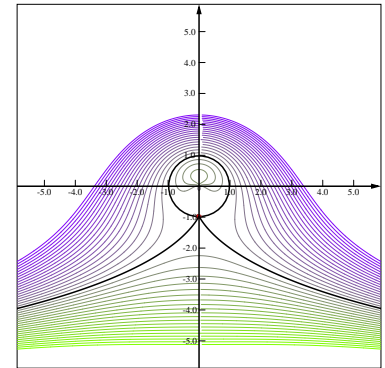

(b) Boundary case for streamlines of doublet in uniform field merged stagnation points.

Fig. -10.16. Doublet in a uniform flow with Vortex in various conditions. Typical condition for the dimensionless Vortex below one and dimensionless vortex equal to one. The figures were generated by the GLE and the program will be available on the on-line version of the book.

(1). The third and the largest root which has the physical meaning is obtained when the dominate term  $\bar{r}^2$  "takes" control.

The results are shown in Figure 10.16. Figure 10.16(a) depicts the stream lines when the dimensionless vortex is below one. Figure 10.16(b) depicts the limiting case where the dimensionless vortex is exactly one. Once the dimensionless vortex exceeds one, the stagnation points do touch the solid body.

#### Example 10.8:

*This question is more as a project for students of Fluid Mechanics or Aerodynamics. The stream lines can be calculated in two ways. The first way is for the given  $n$ , the radius can be calculated from equation (10.187). The second is by calculating the angle for given  $r$  from equation (10.188). Examine the code (attached with the source code) that was used in generating Figures 10.16 and describe or write the algorithm what was used. What is the "dead" radius zones?*

#### Example 10.9:

*Expand the GLE provided code to cover the case where the dimensionless vortex is over one (1).*

### Pressure Distribution Around the solid Body

The interesting part of the above analysis is to find or express the pressure around the body. With this expression the resistance and the lift can be calculated. The body reacts to static pressure, as opposed to dynamic pressure, and hence this part of the

pressure needed to be evaluated. For this process the Bernoulli's equation is utilized and can be written as

$$P_\theta = P_0 - \frac{1}{2}\rho(U_r^2 + U_\theta^2) \quad (10.189)$$

It can be noticed that the two cylindrical components were accounted for. The radial component is zero (no flow cross the stream line) and hence the total velocity is the tangential velocity (see equation (10.177) where  $r = a$ ) which can be written as

$$U_\theta = 2U_0 \sin \theta + \frac{\Gamma}{2\pi a} \quad (10.190)$$

Thus, the pressure on the cylinder can be written as

$$P = P_0 - \frac{1}{2}\rho \left( 4U_0^2 \sin^2 \theta + \frac{2U_0 \Gamma \sin \theta}{\pi a} + \frac{\Gamma^2}{4\pi^2 a^2} \right) \quad (10.191)$$

Equation (10.191) is a parabolic equation with respect to  $\theta$  ( $\sin \theta$ ). The symmetry dictates that D'Alembert's paradox is valid i.e that there is no resistance to the flow. However, in this case there is no symmetry around  $x$  coordinate (see Figure 10.16). The distortion of the symmetry around  $x$  coordinate contribute to lift and expected. The lift can be calculated from the integral around the solid body (stream line) and taking only the  $y$  component. The force elements is

$$dF = -\mathbf{j} \cdot P \mathbf{n} dA \quad (10.192)$$

where in this case  $\mathbf{j}$  is the vertical unit vector in the downward direction, and the infinitesimal area has direction which here is broken into in the value  $dA$  and the standard direction  $\mathbf{n}$ . To carry the integration the unit vector  $\mathbf{n}$  is written as

$$\mathbf{n} = \mathbf{i} \cos \theta + \mathbf{j} \sin \theta \quad (10.193)$$

The reason for definition or split (10.193) to take into account only the the vertical component. Using the above derivation leads to

$$\mathbf{j} \cdot \mathbf{n} = \sin \theta \quad (10.194)$$

The lift per unit length will be

$$L = - \int_0^{2\pi} \left[ P_0 - \frac{1}{2}\rho \left( 4U_0^2 \sin^2 \theta + \frac{2U_0 \Gamma \sin \theta}{\pi a} + \frac{\Gamma^2}{4\pi^2 a^2} \right) \right] \overbrace{\sin \theta}^{eq.(10.194)} a d\theta \quad (10.195)$$

Integration of the  $\sin \theta$  in power of odd number between 0 and  $2\pi$  is zero. Hence the only term that left from the integration (10.195) is

$$L = -\frac{\rho U_0 \Gamma}{\pi a} \int_0^{2\pi} \sin^2 \theta d\theta = U_0 \rho \Gamma \quad (10.196)$$

The lift created by the circulating referred as the Magnus effect which name after a Jewish scientist who live in Germany who discover or observed this phenomenon. In fact, physicists and engineers dismiss this phenomenon is “optical illusion.” However, the physical explanation is based on the viscosity and the vortex is the mechanism that was found to transfer the viscosity to inviscid flow.

In certain ranges the simultaneously translate and rotation movement causes the lift of the moving object. This can be observed in a thrown ball with spin over 1000 rpm and speed in over 5 m/sec. In these parameters, the ball is moving in curved line to the target. To understand the reason for this curving, the schematic if the ball is drawn (Figure 10.17). The ball is moving to the right and rotating counter clockwise. The velocity at the top of the ball is reduced due to the rotation while the velocity at the bottom of the ball is increased. According to Bernoulli’s equation, reduction or increase of the velocity changes the static pressure. Hence, the static pressure is not symmetrical and it causes a force perpendicular to the ball movement. It can be noticed the direction of the rotation changes the direction of the forces. In addition to the change of the pressure, the resistance changes because it is a function of the velocity. In many ranges the increase of the velocity increase the resistance. Hence, there are two different velocities at the top and bottom. The resistance, as a function of the velocity, is different on the bottom as compared to the top. These two different mechanisms cause the ball to move in perpendicular direction to the flow direction.

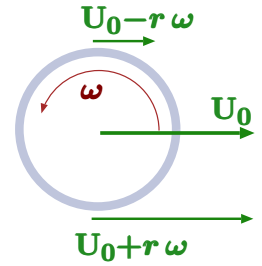

Fig. -10.17. Schematic to explain Magnus’s effect.

The circulation mimics the Magnus’s effect and hence it is used in representative flow. In the above discussion it was used for body of perfect circular shape. However, it was observed that bodies with a very complicated shape such as airplane wing, the lift can be represented by of vortex. This idea was suggested independently by the German Martin Wilhelm Kutta from the numerical method of Runge–Kutta and by the Russian Nikolay Yegorovich Zhukovsky (Joukowski). Zhukovsky suggest that the dimensionless nature of vortex is controlling the any shape. The extension can be done by defining the circulation as

$$\Gamma = \oint_C \mathbf{U} \cdot d\mathbf{s} = \oint_C U \cos \theta ds \tag{10.197}$$

KuttaJoukowski theorem refers to the equation

$$L = -\rho_\infty U_\infty \Gamma, \tag{10.198}$$

The circulation of a ball or cylinder is easy to imagine. Yet a typical air plane do not rotate. Perhaps, the representation of inviscid flow of with vortex can represent the viscous flow. For example flow airplane wing will have typical stream line such as shown in Figure 10.18. However, the viscous

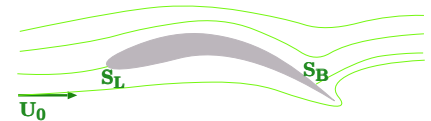

Fig. -10.18. Wing in a typical uniform flow.

flow does not behaves in this fashion especially at the trailing part of the wing. The flow around the wing sheds vortexes because the sharp turn of the flow. The sheds vortexes existence is like the free vortexes since integral including these vortexes can be included in the calculations of the circulation (see equation 10.197).

## 10.4 Conforming Mapping

### 10.4.1 Complex Potential and Complex Velocity

The definition of Cauchy–Riemann equations can lead to the definition of the complex potential  $F(z)$  as following

$$F(z) = \phi(x, y) + i\psi(x, y) \quad (10.199)$$

where  $z = x + iy$ . This definition based on the hope that  $F$  is differentiable and continuous<sup>9</sup> or in other words analytical. In that case a derivative with respect to  $z$  when  $z$  is real number is

$$\frac{dF}{dz} = \frac{dF}{dx} = \frac{d\phi}{dx} + i \frac{d\psi}{dx} \quad (10.200)$$

On the other hand, the derivative with respect to the  $z$  that occurs when  $z$  is pure imaginary number then

$$\frac{dF}{dz} = \frac{1}{i} \frac{dF}{dy} = -i \frac{dF}{dy} = -\frac{d\phi}{dy} + \frac{d\psi}{dy} \quad (10.201)$$

Equations (10.200) and (10.201) show that the derivative with respect to  $z$  depends on the orientation of  $z$ . It is desired that the derivative with respect  $z$  will be independent of the orientation. Hence, the requirement is that the result in both equations must be identical. Hence,

$$\frac{\partial\phi}{\partial x} = \frac{\partial\psi}{\partial y} \quad (10.202)$$

$$\frac{\partial\phi}{\partial y} = -\frac{\partial\psi}{\partial x} \quad (10.203)$$

In fact, the reverse also can be proved that if the Cauchy–Riemann equations condition exists it implies that the complex derivative also must be exist.

Hence, using the complex number guarantees that the Laplacian of the stream function and the potential function must be satisfied (why?). While this method cannot be generalized three dimensions it provides good education purposes and benefits for specific cases. One major advantage of this method is the complex number technique

<sup>9</sup>An analytic function is a function that is locally given by a convergent power series.

can be used without the need to solve differential equation. The derivative of the  $F$  is independent of the orientation of the  $z$  and the complex velocity can be defined as

$$W(z) = \frac{dF}{dz} \quad (10.204)$$

This also can be defined regardless as the direction as

$$W(z) = \frac{dF}{dx} = \frac{\partial\phi}{\partial x} + i \frac{\partial\psi}{\partial x} \quad (10.205)$$

Using the definition that were used for the potential and the stream functions, one can obtain that

$$\frac{dF}{dz} = U_x - i U_y \quad (10.206)$$

The characteristic complex number when multiplied by the conjugate, the results in a real number (hence can be view as scalar) such as

$$W \bar{W} = (U_x - i U_y) (U_x + i U_y) = U_x^2 + U_y^2 \quad (10.207)$$

In Bernoulli's equation the summation of the squares appear and so in equation (10.207). Hence, this multiplication of the complex velocity by its conjugate needs velocity for relationship of pressure–velocity.

The complex numbers sometimes are easier to handle using polar coordinates in such case like finding roots etc. From the Figure the following geometrical transformation can be written

$$U_x = U_r \cos \theta - U_\theta \sin \theta \quad (10.208)$$

and

$$U_y = U_r \sin \theta + U_\theta \cos \theta \quad (10.209)$$

Using the above expression in the complex velocity yields

$$W = (U_r \cos \theta - U_\theta \sin \theta) - i (U_r \sin \theta + U_\theta \cos \theta) \quad (10.210)$$

Combining the  $r$  and  $\theta$  component separately

$$W = U_r (\cos \theta - i \sin \theta) - U_\theta (\cos \theta - i \sin \theta) \quad (10.211)$$

It can be noticed the Euler identity can be used in this case to express the terms that, are multiplying the velocity and since they are similar to obtain

$$W = (U_r - i U_\theta) e^{-i\theta} \quad (10.212)$$

### Uniform Flow



The uniform flow is revisited here with a connection to the complex numbers presentation. In the previous section, the uniform flow was present as the flow from the left to right. Here, this presentation will be expanded. The connection between the mathematical presentation to the physical flow is weak at best and experience is required. One can consider the flow that described by the function

$$F(z) = cz = c(x + i) \quad (10.213)$$

The the complex flow is

$$W = \frac{dF}{dz} = c \quad (10.214)$$

The complex velocity was found to be represented as

$$W = c = U_x - iU_y \quad (10.215)$$

There are three extreme cases that need to be examined. The first case is when  $c$  is a real number. In that case, it requires that  $U_x = c$  which is exactly the case that was presented earlier. The case the constant is imaginary resulting in

$$U_x - iU_y = -ic \quad (10.216)$$

When it was chosen that the constant value is negative it yields

$$U_y = c \quad (10.217)$$

This kind of flow is when the direction is upward and was not discussed in the standard presentation earlier. The third case, the constant is a complex number. In that case, the complex number is present in either polar coordinate for convenience or in Cartesian coordinate to be as

$$F(z) = ce^{-i\theta} z \quad (10.218)$$

The complex velocity will be then

$$W(z) = c \cos \theta - ic \sin \theta \quad (10.219)$$

Hence the component of the velocity are

$$\begin{aligned} U_x &= c \cos \theta \\ U_y &= c \sin \theta \end{aligned} \quad (10.220)$$

This flow is the generalized uniform flow where the flow is in arbitrary angle with the coordinates. In general the uniform flow is described in two-dimensional field as

$$F(z) = U_0 e^{-i\theta} z \quad (10.221)$$

This flow contains two extremes cases discussed earlier horizontal and vertical flow.

### Flow in a Sector

The uniform flow presentation seem to be just repeat of what was done in the presentation without the complex numbers. In sector flow is an example where the complex number presentation starts to shine. The sector flow is referred to as a flow in sector. Sector is a flow in opening with specific angle. The potential is defined as

$$F(z) = U_0 z^n \quad (10.222)$$

where  $n \geq 1$  the relationship between the  $n$  and opening angle will be established in this development. The polar represented is used in this derivations as  $z = r e^{i\theta}$  and substituting into equation (10.222) provides

$$F(z) = U_0 r^n \cos(n\theta) + i U_0 r^n \sin(n\theta) \quad (10.223)$$

The potential function is

$$\phi = U_0 r^n \cos(n\theta) \quad (10.224)$$

and the stream function is

$$\psi = U_0 r^n \sin(n\theta) \quad (10.225)$$

The stream function is zero in two extreme cases: one when the  $\theta = 0$  and two when  $\theta = \pi/n$ . The stream line where  $\psi = 0$  are radial lines at the angles and  $\theta = 0$  and  $\theta = \pi/n$ . The zone between these two line the streamline are defined by the equation of  $\psi = U_0 r^n \sin(n\theta)$ . The complex velocity can be defined as the velocity along these lines and is

$$\begin{aligned} W(z) &= n U_0 z^{n-1} = n U_0 r^{n-1} e^{i(n-1)\theta} = \\ &= n U_0 r^{n-1} \cos(n\theta) + i n U_0 r^{n-1} \sin(n\theta) e^{i\theta} \end{aligned} \quad (10.226)$$

Thus the velocity components are

$$U_r = n U_0 r^{n-1} \cos(n\theta) \quad (10.227)$$

and

$$U_\theta = -n U_0 r^{n-1} \sin(n\theta) \quad (10.228)$$

It can be observed that the radial velocity is positive in the range of  $0 < \theta < \frac{\pi}{2n}$  while it is negative in the range  $\frac{\pi}{2n} < \theta < \frac{\pi}{n}$ . The tangential velocity is negative in the  $0 < \theta < \frac{\pi}{2n}$  while it is positive in the range  $\frac{\pi}{2n} < \theta < \frac{\pi}{n}$ .

In the above discussion it was established the relationship between the sector angle and the power  $n$ . For  $n$  the flow became uniform and increased of the value of

the power,  $n$  reduce the sector. For example if  $n = 2$  the flow is in a right angle sector. Generally the potential of shape corner is given by

$$F(z) = U_0 z^n \quad (10.229)$$

### Flow Around a Sharp Edge

It can be observed that when  $n < 1$  the angle is larger than  $\pi$  this case of flow around sharp corner. This kind of flow creates a significant acceleration that will be dealt in some length in compressible flow under the chapter of Prandtl-Meyer Flow. Here it is assumed that the flow is ideal and there is continuation in the flow and large accelerations are possible.

There is a specific situation where there is a turn around a flat plate. In this extreme case is when the value of  $n < 0.5$ . In that case, the flow turn around the  $2\pi$  angle. In that extreme case the complex potential function is

$$F(z) = c\sqrt{z} \quad (10.230)$$

If the value of  $c$  is taken as real the angle must be limited within the standard  $360^\circ$  and the explicit potential in polar coordinates is

$$F(z) = c\sqrt{r} e^{0.5i\theta} \quad (10.231)$$

The the potential function is

$$\phi = c\sqrt{r} \cos \frac{\theta}{2} \quad (10.232)$$

The stream function is

$$\psi = c\sqrt{r} \sin \frac{\theta}{2} \quad (10.233)$$

The streamlines are along the part the sin zero which occur at  $\theta = 0$  and  $\theta = 2\pi$ .

## 10.5 Unsteady State Bernoulli in Accelerated Coordinates

### 10.6 Questions

1) The potential function is given by

$$\phi = x^5 - 3xy^3 \quad (\text{Question 10.a})$$

Determine the the velocity components of this potential function. Calculate the stream function and sketch the stream function.

2) A Wheel-type flow is a flow describe by the equation

$$U_\theta = U_0 \frac{r}{r_0} \quad (\text{Question 10.b})$$

Where radial velocity is zero  $U_r = 0$  and  $r_0$  is typical dimension in this case. Demonstrate that such flow can be potential flow. Calculate the vorticity in this case.

3) The stream line function is given by the equation

$$\psi = U_0 x + \frac{Q_0}{2\pi} \cot^{-1} \frac{x}{y} \quad (\text{Question 10.c})$$

Calculate the Cartesian components of the velocity field. Sketch the stream line and the stagnation points of the flow.

Table -10.1. Simple Solution to Laplaces' Equation

Name	Stream Function	Potential Function	Complex Potential
	$\psi$	$\phi$	$F(z)$
<b>Uniform Flow in <math>x</math></b>	$U_0 y$	$U_0 x$	$U_0 z$
<b>Source</b>	$\frac{Q}{2\pi} \theta$	$\frac{Q}{2\pi} \ln r$	$\frac{Q}{2\pi} \ln z$
<b>Sink</b>	$-\frac{Q}{2\pi} \theta$	$-\frac{Q}{2\pi} \ln r$	$-\frac{Q}{2\pi} \ln z$
<b>Vortex</b>	$-\frac{\Gamma}{2\pi} \ln r$	$\frac{\Gamma}{2\pi} \theta$	$-\frac{i\Gamma}{2\pi} \ln z$
<b>Doublet</b>	$-\frac{\Gamma}{2\pi} \ln r$	$-\frac{Q}{2\pi} \ln r$	$-\frac{Q}{2\pi} \ln z$
<b>Dipole</b>	$-\frac{\Gamma}{2\pi} \ln r$	$-\frac{Q}{2\pi} \ln r$	$-\frac{Q}{2\pi} \ln z$
<b>Sector Flow</b>	$-\frac{\Gamma}{2\pi} \ln r$	$-\frac{Q}{2\pi} \ln r$	$-\frac{Q}{2\pi} \ln z$

Table -10.2. Axisymmetrical 3-D Flow

Name	Stream Function	Potential Function
<b>Uniform Flow in <math>z</math> direction</b>	$U_0 z = U_0 r \cos \theta$	$\frac{U_0}{2}$
Continued on next page		

Table -10.2. Dimensionless Parameters of Fluid Mechanics (continue)

Standard System		
Name	Stream Function $\psi$	Potential Function $\phi$
Source	$-\frac{Q \cos \theta}{4 \pi} \theta$	$-\frac{Q \cos \theta}{4 \pi} \ln r$
Sink	$\frac{Q \cos \theta}{4 \pi} \theta$	$\frac{Q \cos \theta}{4 \pi} \ln r$
Doublet	$\frac{\Gamma}{4 \pi r} \sin^2 \theta$	$-\frac{\Gamma \cos \theta}{4 \pi r^2}$



---

---

# CHAPTER 11

---

## Compressible Flow One Dimensional

### *11.1 What is Compressible Flow?*

This Chapter deals with an introduction to the flow of compressible substances (gases). The main difference between compressible flow and “almost” incompressible flow is not the fact that compressibility has to be considered. Rather, the difference is in two phenomena that do not exist in incompressible flow. The first phenomenon is the very sharp discontinuity (jump) in the flow in properties. The second phenomenon is the choking of the flow. Choking is referred to as the situation where downstream conditions, which are beyond a critical value(s), doesn't affect the flow.

The shock wave and choking are not intuitive for most people. However, one has to realize that **intuition** is really a condition where one uses his past experiences to predict other situations. Here one has to build his intuition tool for future use. Thus, not only engineers but other disciplines will be able use this “intuition” in design, understanding and even research.

### *11.2 Why Compressible Flow is Important?*

Compressible flow appears in many natural and many technological processes. Compressible flow deals, including many different material such as natural gas, nitrogen and helium, etc not such only air. For instance, the flow of natural gas in a pipe system, a common method of heating in the U.S., should be considered a compressible flow. These processes include flow of gas in the exhaust system of an internal combustion engine. The above flows that were mentioned are called internal flows. Compressible flow also includes flow around bodies such as the wings of an airplane, and is categorized

as external flow.

These processes include situations not expected to have a compressible flow, such as manufacturing process such as the die casting, injection molding. The die casting process is a process in which liquid metal, mostly aluminum, is injected into a mold to obtain a near final shape. The air is displaced by the liquid metal in a very rapid manner, in a matter of milliseconds, therefore the compressibility has to be taken into account.

Clearly, mechanical or aero engineers are not the only ones who have to deal with some aspects of compressible flow. Even manufacturing engineers have to deal with many situations where the compressibility or compressible flow understating is essential for adequate design. Another example, control engineers who are using pneumatic systems must consider compressible flow aspects of the substances used. The compressible flow unique phenomena also appear in zoology (bird fly), geological systems, biological system (human body) etc. These systems require consideration of the unique phenomena of compressible flow.

In this Chapter, a greater emphasis is on the internal flow while the external flow is treated to some extent in the next Chapter. It is recognized that the basic fluid mechanics class has a limited time devoted to these topics. Additional information (such as historical background) can be found in "Fundamentals of Compressible Flow" by the same author on Potto Project web site.

### 11.3 Speed of Sound

Most of compressible flow occurs at relative high velocity as compare to the speed of sound. Hence, the speed of sound has to discussed initially. Outside the ideal gas, limited other situations will be discussed.

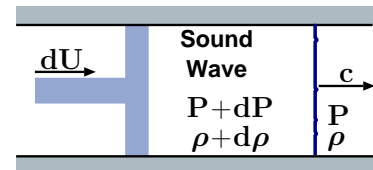

Fig. -11.1. A very slow moving piston in a still gas.

#### 11.3.1 Introduction

People had recognized for several hundred years that sound is a variation of pressure. What is the speed of the small disturbance travel in a "quiet" medium? This velocity is referred to as the speed of sound and is discussed first.

To answer this question consider a piston moving from the left to the right at a relatively small velocity (see Figure 11.1). The information that the piston is moving passes through a single "pressure pulse." It is assumed that if the velocity of the piston is infinitesimally small, the pulse will be infinitesimally small. Thus, the pressure and density can be assumed

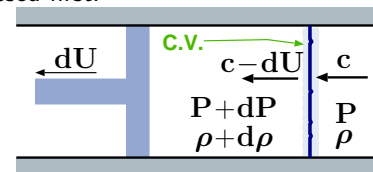

Fig. -11.2. Stationary sound wave and gas moves relative to the pulse.



to be continuous. In the control volume it is convenient to look at a control volume which is attached to a pressure pulse (see Figure 11.2). Applying the mass balance yields

$$\rho c = (\rho + d\rho)(c - dU) \quad (11.1)$$

or when the higher term  $dU d\rho$  is neglected yields

$$\rho dU = c d\rho \implies dU = \frac{cd\rho}{\rho} \quad (11.2)$$

From the energy equation (Bernoulli's equation), assuming isentropic flow and neglecting the gravity results

$$\frac{(c - dU)^2 - c^2}{2} + \frac{dP}{\rho} = 0 \quad (11.3)$$

neglecting second term ( $dU^2$ ) yield

$$-cdU + \frac{dP}{\rho} = 0 \quad (11.4)$$

Substituting the expression for  $dU$  from equation (11.2) into equation (11.4) yields

Sound Speed

$$c^2 \left( \frac{d\rho}{\rho} \right) = \frac{dP}{\rho} \implies c^2 = \frac{dP}{d\rho} \quad (11.5)$$

An expression is needed to represent the right hand side of equation (11.5). For an ideal gas,  $P$  is a function of two independent variables. Here, it is considered that  $P = P(\rho, s)$  where  $s$  is the entropy. The full differential of the pressure can be expressed as follows:

$$dP = \left. \frac{\partial P}{\partial \rho} \right|_s d\rho + \left. \frac{\partial P}{\partial s} \right|_\rho ds \quad (11.6)$$

In the derivations for the speed of sound it was assumed that the flow is isentropic, therefore it can be written

$$\frac{dP}{d\rho} = \left. \frac{\partial P}{\partial \rho} \right|_s \quad (11.7)$$

Note that the equation (11.5) can be obtained by utilizing the momentum equation instead of the energy equation.

#### Example 11.1:

*Demonstrate that equation (11.5) can be derived from the momentum equation.*

SOLUTION

The momentum equation written for the control volume shown in Figure (11.2) is

$$\underbrace{\sum F}_{(P + dP) - P} = \underbrace{\int_{cs} U (\rho U dA)}_{(\rho + d\rho)(c - dU)^2 - \rho c^2} \quad (11.8)$$

Neglecting all the relative small terms results in

$$dP = (\rho + d\rho) \left( c^2 - \cancel{2cdU} + \cancel{dU^2} \right) - \rho c^2 \quad (11.9)$$

And finally it becomes

$$dP = c^2 d\rho \quad (11.10)$$

This yields the same equation as (11.5).

---

End Solution

---

### 11.3.2 Speed of Sound in Ideal and Perfect Gases

The speed of sound can be obtained easily for the equation of state for an ideal gas (also perfect gas as a sub set) because of a simple mathematical expression. The pressure for an ideal gas can be expressed as a simple function of density,  $\rho$ , and a function “molecular structure” or ratio of specific heats,  $k$  namely

$$P = constant \times \rho^k \quad (11.11)$$

and hence

$$\begin{aligned} c &= \sqrt{\frac{dP}{d\rho}} = k \times constant \times \rho^{k-1} = k \times \frac{\overbrace{constant \times \rho^k}^P}{\rho} \\ &= k \times \frac{P}{\rho} \end{aligned} \quad (11.12)$$

Remember that  $P/\rho$  is defined for an ideal gas as  $RT$ , and equation (11.12) can be written as

$$\boxed{\text{Ideal Gas Speed Sound}} \quad c = \sqrt{k RT} \quad (11.13)$$

**Example 11.2:**

Calculate the speed of sound in water vapor at 20[bar] and 350°C, (a) utilizes the steam table (b) assuming ideal gas.

SOLUTION

The solution can be estimated by using the data from steam table<sup>1</sup>

$$c \sim \sqrt{\frac{\Delta P}{\Delta \rho}}_{s=\text{constant}} \quad (11.14)$$

$$\text{At } 20[\text{bar}] \text{ and } 350^\circ\text{C: } s = 6.9563 \left[ \frac{\text{kJ}}{\text{K kg}} \right] \quad \rho = 6.61376 \left[ \frac{\text{kg}}{\text{m}^3} \right]$$

$$\text{At } 18[\text{bar}] \text{ and } 350^\circ\text{C: } s = 7.0100 \left[ \frac{\text{kJ}}{\text{K kg}} \right] \quad \rho = 6.46956 \left[ \frac{\text{kg}}{\text{m}^3} \right]$$

$$\text{At } 18[\text{bar}] \text{ and } 300^\circ\text{C: } s = 6.8226 \left[ \frac{\text{kJ}}{\text{K kg}} \right] \quad \rho = 7.13216 \left[ \frac{\text{kg}}{\text{m}^3} \right]$$

After interpretation of the temperature:

$$\text{At } 18[\text{bar}] \text{ and } 335.7^\circ\text{C: } s \sim 6.9563 \left[ \frac{\text{kJ}}{\text{K kg}} \right] \quad \rho \sim 6.94199 \left[ \frac{\text{kg}}{\text{m}^3} \right]$$

and substituting into the equation yields

$$c = \sqrt{\frac{200000}{0.32823}} = 780.5 \left[ \frac{\text{m}}{\text{sec}} \right] \quad (11.15)$$

for ideal gas assumption (data taken from Van Wylen and Sontag, Classical Thermodynamics, table A 8.)

$$c = \sqrt{kRT} \sim \sqrt{1.327 \times 461 \times (350 + 273)} \sim 771.5 \left[ \frac{\text{m}}{\text{sec}} \right]$$

Note that a better approximation can be done with a steam table, and it ...

---

End Solution

### 11.3.3 Speed of Sound in Almost Incompressible Liquid

Every liquid in reality has a small and important compressible aspect. The ratio of the change in the fractional volume to pressure or compression is referred to as the bulk modulus of the material. For example, the average bulk modulus for water is  $2.2 \times 10^9 \text{ N/m}^2$ . At a depth of about 4,000 meters, the pressure is about  $4 \times 10^7 \text{ N/m}^2$ . The fractional volume change is only about 1.8% even under this pressure nevertheless it is a change.

The compressibility of the substance is the reciprocal of the bulk modulus. The amount of compression of almost all liquids is seen to be very small as given in the Book "Fundamentals of Compressible Flow." The mathematical definition of bulk modulus as following

$$B_T = \rho \frac{dP}{d\rho} \quad (11.16)$$

<sup>1</sup>This data is taken from Van Wylen and Sontag "Fundamentals of Classical Thermodynamics" 2nd edition

In physical terms can be written as

$$c = \sqrt{\frac{\text{elastic property}}{\text{inertial property}}} = \sqrt{\frac{B_T}{\rho}} \quad (11.17)$$

For example for water

$$c = \sqrt{\frac{2.2 \times 10^9 \text{ N/m}^2}{1000 \text{ kg/m}^3}} = 1493 \text{ m/s}$$

This value agrees well with the measured speed of sound in water, 1482 m/s at 20°C. A list with various typical velocities for different liquids can be found in "Fundamentals of Compressible Flow" by by this author. The interesting topic of sound in variable compressible liquid also discussed in the above book. It can be shown that velocity in solid and and slightly compressible liquid is expressed by In summary, the speed of sound in liquids is about 3 to 5 relative to the speed of sound in gases.

### 11.3.4 Speed of Sound in Solids

The situation with solids is considerably more complicated, with different speeds in different directions, in different kinds of geometries, and differences between transverse and longitudinal waves. Nevertheless, the speed of sound in solids is larger than in liquids and definitely larger than in gases.

Young's Modulus for a representative value for the bulk modulus for steel is  $160 \times 10^9 \text{ N/m}^2$ . A list of materials with their typical velocity can be found in the above book.

Speed of sound in solid of steel, using a general tabulated value for the bulk modulus, gives a sound speed for structural steel of

$$c = \sqrt{\frac{E}{\rho}} = \sqrt{\frac{160 \times 10^9 \text{ N/m}^2}{7860 \text{ Kg/m}^3}} = 4512 \text{ m/s}$$

Compared to one tabulated value the example values for stainless steel lays between the speed for longitudinal and transverse waves.

### 11.3.5 The Dimensional Effect of the Speed of Sound

What is the significance of the speed of sound? This speed of sound determines what regime the flow will be. In Chapter 9 that Mach number was described as important parameter. It will be shown later in this Chapter that when Mach number is around 0.25-0.3 a significant change occur in the situation of flow. To demonstrate this point,

consider a two dimensional situation where a particle is moving from the left to the right. A particle movement creates a pressure change which travels toward outside in equal speed relative to the particle. Figure 11.3 depicts an object with three different relative velocities. Figure 11.3(a) demonstrates that the whole surroundings is influenced by the object (depicted by red color). While Figure 11.3 (b) that there small zone a head object that is "aware" if the object arriving. In Figure 11.3 (c) the zone that aware of the object is practically zero.

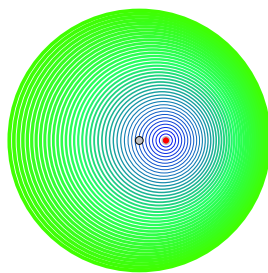

(a) Object travels at 0.005 of the speed of sound

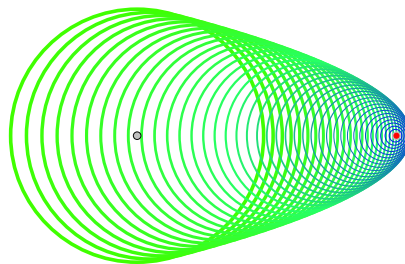

(b) Object travels at 0.05 of the speed of sound

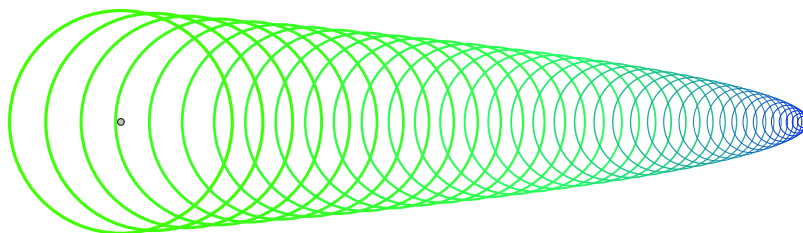

(c) Object travels at 0.15 of the speed of sound

*Fig. -11.3. Moving object at three relative velocities. The gray point in the first circle is the initial point the object. The final point is marked by red circled with gray filled. Notice that the circle line thickness is increase with the time i.e the more green wider circle line thickness. The transition from the blue fresher lines to the green older lines is properly marked.*

In fact, when the object velocity is about or larger than the speed of sound then the object arrive to location where the fluid does not aware or informed about the object. The reason that in gas the compressibility plays significant role is because the ratio of the object or fluid velocity compared to speed of sound. In gases the speed of sound is smaller as compare to liquid and defentdly to solid. Hence, gases are media where compressibility effect must be considered in realtionshp compressibility. There are some how defined the Mach cone as the shape of object movement approaching to one. This shape has angle and it related to Mach angle.

## 11.4 Isentropic Flow

In this section a discussion on a steady state flow through a smooth and without an abrupt area change which include converging–diverging nozzle is presented. The isentropic flow models are important because of two main reasons: One, it provides the information about the trends and important parameters. Two, the correction factors can be introduced later to account for deviations from the ideal state.

### 11.4.1 Stagnation State for Ideal Gas Model

It is assumed that the flow is quasi one–dimensional (that is the fluid flows mainly in one dimension). Figure (11.4) describes a gas flow through a converging–diverging nozzle. It has been found that a theoretical state known as the stagnation state is very useful in simplifying the solution and treatment of the flow. The stagnation state is a theoretical state in which the flow is brought into a complete motionless conditions in isentropic process without other forces (e.g. gravity force). Several properties that can be represented by this theoretical process which include temperature, pressure, and density et cetera and denoted by the subscript “0.”

First, the stagnation temperature is calculated. The energy conservation can be written as

$$h + \frac{U^2}{2} = h_0 \quad (11.18)$$

Perfect gas is an ideal gas with a constant heat capacity,  $C_p$ . For perfect gas equation (11.18) is simplified into

$$C_p T + \frac{U^2}{2} = C_p T_0 \quad (11.19)$$

$T_0$  is denoted as the stagnation temperature. Recalling from thermodynamic the relationship for perfect gas  $R = C_p - C_v$  and denoting  $k \equiv C_p \div C_v$  then the thermodynamics relationship obtains the form

$$C_p = \frac{k R}{k - 1} \quad (11.20)$$

and where  $R$  is the specific constant. Dividing equation (11.19) by  $(C_p T)$  yields

$$1 + \frac{U^2}{2 C_p T} = \frac{T_0}{T} \quad (11.21)$$

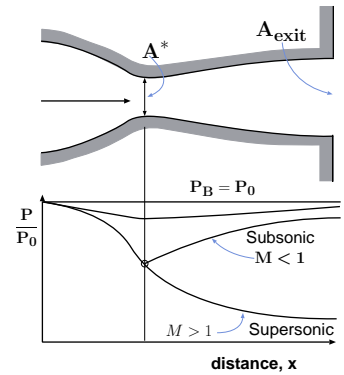

Fig. -11.4. Flow of a compressible substance (gas) through a converging–diverging nozzle.

Now, substituting  $c^2 = k R T$  or  $T = c^2/k R$  equation (11.21) changes into

$$1 + \frac{k R U^2}{2 C_p c^2} = \frac{T_0}{T} \tag{11.22}$$

By utilizing the definition of  $k$  by equation (2.24) and inserting it into equation (11.22) yields

$$1 + \frac{k - 1}{2} \frac{U^2}{c^2} = \frac{T_0}{T} \tag{11.23}$$

It very useful to convert equation (11.22) into a dimensionless form and denote Mach number as the ratio of velocity to speed of sound as

**Mach Number Definition**

$$M \equiv \frac{U}{c} \tag{11.24}$$

Inserting the definition of Mach number (11.24) into equation (11.23) reads

**Isentropic Temperature relationship**

$$\frac{T_0}{T} = 1 + \frac{k - 1}{2} M^2 \tag{11.25}$$

The usefulness of Mach number and equation (11.25) can be demonstrated by the following simple example. In this example a gas flows through a tube (see Figure 11.5) of any shape can be expressed as a function of only the stagnation temperature as opposed to the function of the temperatures and velocities.

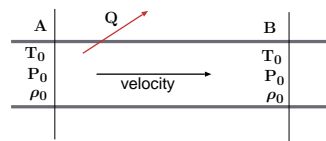

Fig. -11.5. Perfect gas flows through a tube

The definition of the stagnation state provides the advantage of compact writing. For example, writing the energy equation for the tube shown in Figure (11.5) can be reduced to

$$\dot{Q} = C_p (T_{0B} - T_{0A}) \dot{m} \tag{11.26}$$

The ratio of stagnation pressure to the static pressure can be expressed as the function of the temperature ratio because of the isentropic relationship as

**Isentropic Pressure Definition**

$$\frac{P_0}{P} = \left( \frac{T_0}{T} \right)^{\frac{k}{k-1}} = \left( 1 + \frac{k - 1}{2} M^2 \right)^{\frac{k}{k-1}} \tag{11.27}$$

In the same manner the relationship for the density ratio is

**Isentropic Density**

$$\frac{\rho_0}{\rho} = \left(\frac{T_0}{T}\right)^{\frac{1}{k-1}} = \left(1 + \frac{k-1}{2} M^2\right)^{\frac{1}{k-1}} \quad (11.28)$$

New useful definitions are introduced for the case when  $M = 1$  and denoted by superscript “\*.” The special cases of ratio of the star values to stagnation values are dependent only on the heat ratio as the following:

**Star Relationship**

$$\begin{aligned} \frac{T^*}{T_0} &= \frac{c^{*2}}{c_0^2} \\ \frac{V_2}{V_1} &= \left(\frac{T_1}{T_2}\right)^{\frac{1}{k-1}} = \left(\frac{\rho_1}{\rho_2}\right) = \left(\frac{P_1}{P_2}\right)^{\frac{1}{k}} \\ \frac{P^*}{P_0} &= \left(\frac{2}{k+1}\right)^{\frac{k}{k-1}} \\ \frac{\rho^*}{\rho_0} &= \left(\frac{2}{k+1}\right)^{\frac{1}{k-1}} \end{aligned} \quad (11.29)$$

Using all the definitions above relationship between the stagnation properties to star speed of sound are

$$c^* = \sqrt{k R \frac{2T_0}{k+2}} \quad (11.30)$$

### 11.4.2 Isentropic Converging-Diverging Flow in Cross Section

The important sub case in this chapter is the flow in a converging-diverging nozzle. The control volume is shown in Figure (11.7). There are two models that assume variable area flow: First is isentropic and adiabatic model. Second is isentropic and isothermal model. Here only the first model will be described. Clearly, the stagnation temperature,  $T_0$ , is constant through the adiabatic flow because there isn't heat transfer. Therefore, the stagnation pressure is also constant through the flow because the flow isentropic. Conversely, in mathematical terms, equation (11.25) and equation (11.27) are the same. If the right hand side is constant for one variable, it

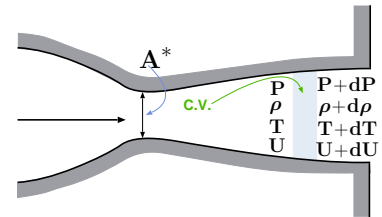

Fig. -11.7. Control volume inside a converging-diverging nozzle.



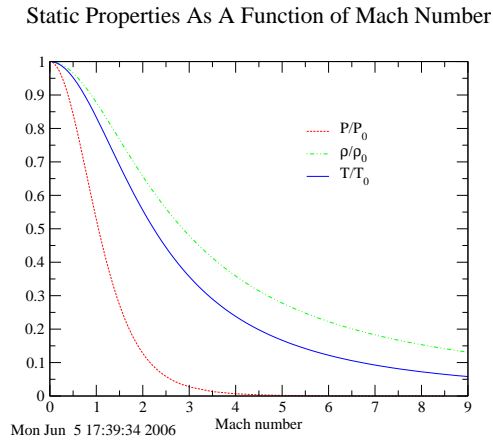

Fig. -11.6. The stagnation properties as a function of the Mach number,  $k=1.4$ .

is constant for the other. In the same vein, the stagnation density is constant through the flow. Thus, knowing the Mach number or the temperature will provide all that is needed to find the other properties. The only properties that need to be connected are the cross section area and the Mach number. Examination of the relation between properties can then be carried out.

### 11.4.3 The Properties in the Adiabatic Nozzle

When there is no external work and heat transfer, the energy equation, reads

$$dh + U dU = 0 \quad (11.31)$$

Differentiation of continuity equation,  $\rho AU = \dot{m} = \text{constant}$ , and dividing by the continuity equation reads

$$\frac{d\rho}{\rho} + \frac{dA}{A} + \frac{dU}{U} = 0 \quad (11.32)$$

The thermodynamic relationship between the properties can be expressed as

$$T ds = dh - \frac{dP}{\rho} \quad (11.33)$$

For isentropic process  $ds \equiv 0$  and combining equations (11.31) with (11.33) yields

$$\frac{dP}{\rho} + U dU = 0 \quad (11.34)$$

Differentiation of the equation state (perfect gas),  $P = \rho RT$ , and dividing the results by the equation of state ( $\rho RT$ ) yields

$$\frac{dP}{P} = \frac{d\rho}{\rho} + \frac{dT}{T} \quad (11.35)$$

Obtaining an expression for  $dU/U$  from the mass balance equation (11.32) and using it in equation (11.34) reads

$$\frac{dP}{\rho} - U^2 \overbrace{\left[ \frac{dA}{A} + \frac{d\rho}{\rho} \right]}^{\frac{dU}{U}} = 0 \quad (11.36)$$

Rearranging equation (11.36) so that the density,  $\rho$ , can be replaced by the static pressure,  $dP/\rho$  yields

$$\frac{dP}{\rho} = U^2 \left( \frac{dA}{A} + \frac{d\rho}{\rho} \frac{dP}{dP} \right) = U^2 \left( \frac{dA}{A} + \overbrace{\frac{d\rho}{dP} \frac{dP}{\rho}}^{\frac{1}{c^2}} \right) \quad (11.37)$$

Recalling that  $dP/d\rho = c^2$  and substitute the speed of sound into equation (11.37) to obtain

$$\frac{dP}{\rho} \left[ 1 - \left( \frac{U}{c} \right)^2 \right] = U^2 \frac{dA}{A} \quad (11.38)$$

Or in a dimensionless form

$$\frac{dP}{\rho} (1 - M^2) = U^2 \frac{dA}{A} \quad (11.39)$$

Equation (11.39) is a differential equation for the pressure as a function of the cross section area. It is convenient to rearrange equation (11.39) to obtain a variables separation form of

$$dP = \frac{\rho U^2}{A} \frac{dA}{1 - M^2} \quad (11.40)$$

#### 11.4.3.1 The pressure Mach number relationship

Before going further in the mathematical derivations it is worth looking at the physical meaning of equation (11.40). The term  $\rho U^2/A$  is always positive (because all the three terms can be only positive). Now, it can be observed that  $dP$  can be positive or negative depending on the  $dA$  and Mach number. The meaning of the sign change for the pressure differential is that the pressure can increase or decrease. It can be observed

that the critical Mach number is one. If the Mach number is larger than one than  $dP$  has opposite sign of  $dA$ . If Mach number is smaller than one  $dP$  and  $dA$  have the same sign. For the subsonic branch  $M < 1$  the term  $1/(1 - M^2)$  is positive hence

$$\begin{aligned}dA > 0 &\implies dP > 0 \\dA < 0 &\implies dP < 0\end{aligned}$$

From these observations the trends are similar to those in incompressible fluid. An increase in area results in an increase of the static pressure (converting the dynamic pressure to a static pressure). Conversely, if the area decreases (as a function of  $x$ ) the pressure decreases. Note that the pressure decrease is larger in compressible flow compared to incompressible flow.

For the supersonic branch  $M > 1$ , the phenomenon is different. For  $M > 1$  the term  $1/1 - M^2$  is negative and change the character of the equation.

$$\begin{aligned}dA > 0 &\implies dP < 0 \\dA < 0 &\implies dP > 0\end{aligned}$$

This behavior is opposite to incompressible flow behavior.

For the special case of  $M = 1$  (sonic flow) the value of the term  $1 - M^2 = 0$  thus mathematically  $dP \rightarrow \infty$  or  $dA = 0$ . Since physically  $dP$  can increase only in a finite amount it must that  $dA = 0$ . It must also be noted that when  $M = 1$  occurs only when  $dA = 0$ . However, the opposite, not necessarily means that when  $dA = 0$  that  $M = 1$ . In that case, it is possible that  $dM = 0$  thus the diverging side is in the subsonic branch and the flow isn't choked.

The relationship between the velocity and the pressure can be observed from equation (11.34) by solving it for  $dU$ .

$$dU = -\frac{dP}{P U} \quad (11.41)$$

From equation (11.41) it is obvious that  $dU$  has an opposite sign to  $dP$  (since the term  $PU$  is positive). Hence the pressure increases when the velocity decreases and vice versa.

From the speed of sound, one can observe that the density,  $\rho$ , increases with pressure and vice versa (see equation (11.42)).

$$d\rho = \frac{1}{c^2} dP \quad (11.42)$$

It can be noted that in the derivations of the above equations (11.41 - 11.42), the equation of state was not used. Thus, the equations are applicable for any gas (perfect or imperfect gas).

The second law (isentropic relationship) dictates that  $ds = 0$  and from thermodynamics

$$ds = 0 = C_p \frac{dT}{T} - R \frac{dP}{P}$$

and for perfect gas

$$\frac{dT}{T} = \frac{k-1}{k} \frac{dP}{P} \quad (11.43)$$

Thus, the temperature varies in the same way that pressure does.

The relationship between the Mach number and the temperature can be obtained by utilizing the fact that the process is assumed to be adiabatic  $dT_0 = 0$ . Differentiation of equation (11.25), the relationship between the temperature and the stagnation temperature becomes

$$dT_0 = 0 = dT \left( 1 + \frac{k-1}{2} M^2 \right) + T(k-1)M dM \quad (11.44)$$

and simplifying equation (11.44) yields

$$\frac{dT}{T} = - \frac{(k-1) M dM}{1 + \frac{k-1}{2} M^2} \quad (11.45)$$

#### 11.4.3.2 Relationship Between the Mach Number and Cross Section Area

The equations used in the solution are energy (11.45), second law (11.43), state (11.35), mass (11.32)<sup>2</sup>. Note, equation (11.39) isn't the solution but demonstration of certain properties of the pressure profile.

The relationship between temperature and the cross section area can be obtained by utilizing the relationship between the pressure and temperature (11.43) and the relationship of pressure with cross section area (11.39). First stage equation (11.45) is combined with equation (11.43) and becomes

$$\frac{(k-1)}{k} \frac{dP}{P} = - \frac{(k-1) M dM}{1 + \frac{k-1}{2} M^2} \quad (11.46)$$

Combining equation (11.46) with equation (11.39) yields

$$\frac{1}{k} \frac{\rho U^2}{A} \frac{dA}{1-M^2} = - \frac{M dM}{1 + \frac{k-1}{2} M^2} \quad (11.47)$$

The following identify,  $\rho U^2 = k M P$  can be proved as

$$k M^2 P = k \frac{\overbrace{U^2}^{M^2}}{c^2} \overbrace{\rho R T}^P = k \frac{U^2}{k R T} \overbrace{\rho R T}^P = \rho U^2 \quad (11.48)$$

<sup>2</sup>The momentum equation is not used normally in isentropic process, why?

Using the identity in equation (11.48) changes equation (11.47) into

$$\frac{dA}{A} = \frac{M^2 - 1}{M \left( 1 + \frac{k-1}{2} M^2 \right)} dM \quad (11.49)$$

Equation (11.49) is very important because it relates the geometry (area) with the relative velocity (Mach number). In equation (11.49), the factors  $M \left( 1 + \frac{k-1}{2} M^2 \right)$  and  $A$  are positive regardless of the values of  $M$  or  $A$ . Therefore, the only factor that affects relationship between the cross area and the Mach number is  $M^2 - 1$ . For  $M < 1$  the Mach number is varied opposite to the cross section area. In the case of  $M > 1$  the Mach number increases with the cross section area and vice versa. The special case is when  $M = 1$  which requires that  $dA = 0$ . This condition imposes that internal<sup>3</sup> flow has to pass a converging-diverging device to obtain supersonic velocity. This minimum area is referred to as "throat."

Again, the opposite conclusion that when  $dA = 0$  implies that  $M = 1$  is not correct because possibility of  $dM = 0$ . In subsonic flow branch, from the mathematical point of view: on one hand, a decrease of the cross section increases the velocity and the Mach number, on the other hand, an increase of the cross section decreases the velocity and Mach number (see Figure (11.8)).

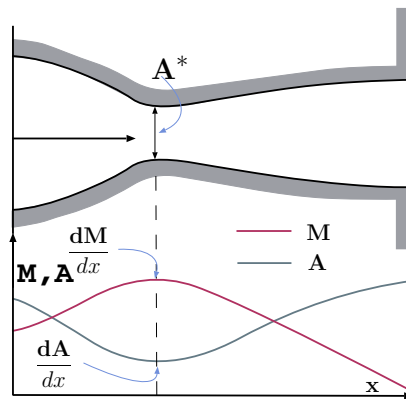

Fig. -11.8. The relationship between the cross section and the Mach number on the subsonic branch

#### 11.4.4 Isentropic Flow Examples

Example 11.3:

Air is allowed to flow from a reservoir with temperature of  $21^\circ\text{C}$  and with pressure of  $5[\text{MPa}]$  through a tube. It was measured that air mass flow rate is  $1[\text{kg}/\text{sec}]$ . At some point on the tube static pressure was measured to be  $3[\text{MPa}]$ . Assume that process is isentropic and neglect the velocity at the reservoir, calculate the Mach number, velocity, and the cross section area at that point where the static pressure was measured. Assume that the ratio of specific heat is  $k = C_p/C_v = 1.4$ .

#### SOLUTION

The stagnation conditions at the reservoir will be maintained throughout the tube because the process is isentropic. Hence the stagnation temperature can be written

<sup>3</sup>This condition does not impose any restrictions for external flow. In external flow, an object can be moved in arbitrary speed.

$T_0 = \text{constant}$  and  $P_0 = \text{constant}$  and both of them are known (the condition at the reservoir). For the point where the static pressure is known, the Mach number can be calculated by utilizing the pressure ratio. With the known Mach number, the temperature, and velocity can be calculated. Finally, the cross section can be calculated with all these information.

In the point where the static pressure known

$$\bar{P} = \frac{P}{P_0} = \frac{3[\text{MPa}]}{5[\text{MPa}]} = 0.6$$

From Table (11.2) or from Figure (11.6) or utilizing the enclosed program, Potto-GDC, or simply using the equations shows that

M	$\frac{T}{T_0}$	$\frac{\rho}{\rho_0}$	$\frac{A}{A^*}$	$\frac{P}{P_0}$	$\frac{A \times P}{A^* \times P_0}$	$\frac{F}{F^*}$
0.88639	0.86420	0.69428	1.0115	0.60000	0.60693	0.53105

With these values the static temperature and the density can be calculated.

$$T = 0.86420338 \times (273 + 21) = 254.076K$$

$$\rho = \frac{\rho}{\rho_0} \frac{P_0}{RT_0} = 0.69428839 \times \frac{5 \times 10^6 [\text{Pa}]}{287.0 \left[ \frac{\text{J}}{\text{kgK}} \right] \times 294 [\text{K}]}$$

$$= 41.1416 \left[ \frac{\text{kg}}{\text{m}^3} \right]$$

The velocity at that point is

$$U = M \sqrt{k R T} = 0.88638317 \times \sqrt{1.4 \times 287 \times 294} = 304 [\text{m/sec}]$$

The tube area can be obtained from the mass conservation as

$$A = \frac{\dot{m}}{\rho U} = 8.26 \times 10^{-5} [\text{m}^2]$$

For a circular tube the diameter is about 1[cm].

---

End Solution

---

#### Example 11.4:

The Mach number at point A on tube is measured to be  $M = 2^4$  and the static pressure is  $2[\text{Bar}]^5$ . Downstream at point B the pressure was measured to be  $1.5[\text{Bar}]$ . Calculate the Mach number at point B under the isentropic flow assumption. Also, estimate the temperature at point B. Assume that the specific heat ratio  $k = 1.4$  and assume a perfect gas model.

<sup>5</sup>This pressure is about two atmospheres with temperature of  $250[\text{K}]$

SOLUTION

With the known Mach number at point A all the ratios of the static properties to total (stagnation) properties can be calculated. Therefore, the stagnation pressure at point A is known and stagnation temperature can be calculated.

At  $M = 2$  (supersonic flow) the ratios are

M	$\frac{T}{T_0}$	$\frac{\rho}{\rho_0}$	$\frac{A}{A^*}$	$\frac{P}{P_0}$	$\frac{A \times P}{A^* \times P_0}$	$\frac{F}{F^*}$
2.0000	0.55556	0.23005	1.6875	0.12780	0.21567	0.59309

With this information the pressure at point B can be expressed as

$$\frac{P_A}{P_0} = \underbrace{\frac{P_B}{P_0}}_{11.2 @ M=2} \times \frac{P_A}{P_B} = 0.12780453 \times \frac{2.0}{1.5} = 0.17040604$$

The corresponding Mach number for this pressure ratio is 1.8137788 and  $T_B = 0.60315132 \frac{P_B}{P_0} = 0.17040879$ . The stagnation temperature can be "bypassed" to calculate the temperature at point B

$$T_B = T_A \times \underbrace{\frac{T_0}{T_A}}_{M=2} \times \underbrace{\frac{T_B}{T_0}}_{M=1.81..} = 250[K] \times \frac{1}{0.55555556} \times 0.60315132 \simeq 271.42[K]$$

---

End Solution

**Example 11.5:**

Gas flows through a converging-diverging duct. At point "A" the cross section area is 50 [cm<sup>2</sup>] and the Mach number was measured to be 0.4. At point B in the duct the cross section area is 40 [cm<sup>2</sup>]. Find the Mach number at point B. Assume that the flow is isentropic and the gas specific heat ratio is 1.4.

SOLUTION

To obtain the Mach number at point B by finding the ratio of the area to the critical area. This relationship can be obtained by

$$\frac{A_B}{A^*} = \frac{A_B}{A_A} \times \frac{A_A}{A^*} = \frac{40}{50} \times \underbrace{1.59014}_{\text{from the Table 11.2}} = 1.272112$$

<sup>5</sup>Well, this question is for academic purposes, there is no known way for the author to directly measure the Mach number. The best approximation is by using inserted cone for supersonic flow and measure the oblique shock. Here it is subsonic and this technique is not suitable.

With the value of  $\frac{A}{A^*}$  from the Table (11.2) or from Potto-GDC two solutions can be obtained. The two possible solutions: the first supersonic  $M = 1.6265306$  and second subsonic  $M = 0.53884934$ . Both solution are possible and acceptable. The supersonic branch solution is possible only if there where a transition at throat where  $M=1$ .

M	$\frac{T}{T_0}$	$\frac{\rho}{\rho_0}$	$\frac{A}{A^*}$	$\frac{P}{P_0}$	$\frac{A \times P}{A^* \times P_0}$
1.6266	0.65396	0.34585	1.2721	0.22617	0.28772
0.53887	0.94511	0.86838	1.2721	0.82071	1.0440

---

End Solution

---

#### Example 11.6:

*Engineer needs to redesign a syringe for medical applications. They complained that the syringe is "hard to push." The engineer analyzes the flow and conclude that the flow is choke. Upon this fact, what engineer should do with the syringe; increase the pushing diameter or decrease the diameter? Explain.*

#### SOLUTION

This problem is a typical to compressible flow in the sense the solution is opposite the regular intuition. The diameter should be decreased. The pressure in the choke flow in the syringe is past the critical pressure ratio. Hence, the force is a function of the cross area of the syringe. So, to decrease the force one should decrease the area.

---

End Solution

---

### 11.4.5 Mass Flow Rate (Number)

One of the important engineering parameters is the mass flow rate which for ideal gas is

$$\dot{m} = \rho U A = \frac{P}{RT} U A \quad (11.50)$$

This parameter is studied here, to examine the maximum flow rate and to see what is the effect of the compressibility on the flow rate. The area ratio as a function of the Mach number needed to be established, specifically and explicitly the relationship for the choked flow. The area ratio is defined as the ratio of the cross section at any point to the throat area (the narrow area). It is convenient to rearrange the equation (11.50) to be expressed in terms of the stagnation properties as

$$\frac{\dot{m}}{A} = \frac{P}{P_0} \frac{P_0 U}{\sqrt{k R T}} \sqrt{\frac{k}{R}} \sqrt{\frac{T_0}{T}} \frac{1}{\sqrt{T_0}} = \frac{P_0}{\sqrt{T_0}} M \sqrt{\frac{k}{R}} \frac{P}{P_0} \sqrt{\frac{T_0}{T}} \quad (11.51)$$



Expressing the temperature in terms of Mach number in equation (11.51) results in

$$\frac{\dot{m}}{A} = \left( \frac{k M P_0}{\sqrt{k R T_0}} \right) \left( 1 + \frac{k-1}{2} M^2 \right)^{-\frac{k+1}{2(k-1)}} \quad (11.52)$$

It can be noted that equation (11.52) holds everywhere in the converging-diverging duct and this statement also true for the throat. The throat area can be denoted as by  $A^*$ . It can be noticed that at the throat when the flow is choked or in other words  $M = 1$  and that the stagnation conditions (i.e. temperature, pressure) do not change. Hence equation (11.52) obtained the form

$$\frac{\dot{m}}{A^*} = \left( \frac{\sqrt{k} P_0}{\sqrt{R T_0}} \right) \left( 1 + \frac{k-1}{2} \right)^{-\frac{k+1}{2(k-1)}} \quad (11.53)$$

Since the mass flow rate is constant in the duct, dividing equations (11.53) by equation (11.52) yields

**Mass Flow Rate Ratio**

$$\frac{A}{A^*} = \frac{1}{M} \left( \frac{1 + \frac{k-1}{2} M^2}{\frac{k+1}{2}} \right)^{-\frac{k+1}{2(k-1)}} \quad (11.54)$$

Equation (11.54) relates the Mach number at any point to the cross section area ratio.

The maximum flow rate can be expressed either by taking the derivative of equation (11.53) in with respect to  $M$  and equating to zero. Carrying this calculation results at  $M = 1$ .

$$\left( \frac{\dot{m}}{A^*} \right)_{max} \frac{P_0}{\sqrt{T_0}} = \sqrt{\frac{k}{R}} \left( \frac{k+1}{2} \right)^{-\frac{k+1}{2(k-1)}} \quad (11.55)$$

For specific heat ratio,  $k = 1.4$

$$\left( \frac{\dot{m}}{A^*} \right)_{max} \frac{P_0}{\sqrt{T_0}} \sim \frac{0.68473}{\sqrt{R}} \quad (11.56)$$

The maximum flow rate for air ( $R = 287 \text{ J/kgK}$ ) becomes,

$$\frac{\dot{m} \sqrt{T_0}}{A^* P_0} = 0.040418 \quad (11.57)$$

Equation (11.57) is known as Fliegner's Formula on the name of one of the first engineers who observed experimentally the choking phenomenon. It can be noticed that Fliegner's equation can lead to definition of the Fliegner's Number.

$$\frac{\dot{m} \sqrt{T_0}}{A^* P_0} = \frac{\overbrace{\dot{m} \sqrt{k R T_0}}^{c_0}}{\sqrt{k R A^* P_0}} = \frac{1}{\sqrt{R}} \frac{\overbrace{\dot{m} c_0}^{Fn}}{A^* P_0} \frac{1}{\sqrt{k}} \quad (11.58)$$

The definition of Fliegner's number ( $F_n$ ) is

$$F_n \equiv \frac{\sqrt{R} \dot{m} c_0}{\sqrt{R} A^* P_0} \quad (11.59)$$

Utilizing Fliegner's number definition and substituting it into equation (11.53) results in

Fliegner's Number

$$F_n = k M \left( 1 + \frac{k-1}{2} M^2 \right)^{-\frac{k+1}{2(k-1)}} \quad (11.60)$$

and the maximum point for  $F_n$  at  $M = 1$  is

$$F_n = k \left( \frac{k+1}{2} \right)^{-\frac{k+1}{2(k-1)}} \quad (11.61)$$

**Example 11.7:**

Why  $F_n$  is zero at Mach equal to zero? Prove Fliegner number,  $F_n$  is maximum at  $M = 1$ .

**Example 11.8:**

The pitot tube measured the temperature of a flow which was found to be  $300^\circ\text{C}$ . The static pressure was measured to be 2 [Bar]. The flow rate is 1 [kg/sec] and area of the conduct is 0.001 [ $\text{m}^2$ ]. Calculate the Mach number, the velocity of the stream, and stagnation pressure. Assume perfect gas model with  $k=1.42$ .

SOLUTION

This exactly the case discussed above in which the the ratio of mass flow rate to the area is given along with the stagnation temperature and static pressure. Utilizing equation (??) will provide the solution.

$$\frac{R T_0}{P^2} \left( \frac{\dot{m}}{A} \right)^2 = \frac{287 \times 373}{200,000^2} \times \left( \frac{1}{0.001} \right)^2 = 2.676275 \quad (11.VIII.a)$$

According to Table 11.1 the Mach number is about  $M = 0.74 \dots$  (the exact number does not appear here demonstrate the simplicity of the solution). The Velocity can be obtained from the

$$U = M c = M \sqrt{k R T} \quad (11.VIII.b)$$

The only unknown the equation (11.VIII.b) is the temperature. However, the temperature can be obtained from knowing the Mach number with the "regular" table. Utilizing the regular table or Potto GDC one obtained.

M	$\frac{T}{T_0}$	$\frac{\rho}{\rho_0}$	$\frac{A}{A^*}$	$\frac{P}{P_0}$	$\frac{A \times P}{A^* \times P_0}$	$\frac{F}{F^*}$
0.74000	0.89686	0.77169	1.0677	0.69210	0.73898	0.54281

The temperature is then

$$T = (287 + 300) \times 0.89686 \sim 526.45K \sim 239.4^\circ\text{C} \quad (11.VIII.c)$$

Hence the velocity is

$$U = 0.74 \times \sqrt{1.42 \times 287 \times 526.45} \sim 342.76[m/sec] \quad (11.VIII.d)$$

In the same way the static pressure is

$$P_0 = P \left/ \frac{P}{P_0} \right. \sim 2/0.692 \sim 2.89[Bar] \quad (11.VIII.e)$$

The usage of Table 11.1 is only approximation and the exact value can be obtained utilizing Potto GDC.

---

End Solution

---

#### Example 11.9:

Calculate the Mach number for flow with given stagnation pressure of 2 [Bar] and 27° C. It is given that the mass flow rate is 1 [kg/sec] and the cross section area is 0.01[m<sup>2</sup>]. Assume that the specific heat ratios,  $k = 1.4$ .

#### SOLUTION

To solve this problem, the ratio in equation (??) has to be found.

$$\left( \frac{A^* P_0}{A P} \right)^2 = \frac{RT}{P_0^2} \left( \frac{\dot{m}}{A} \right)^2 = \frac{287 \times 300}{200000^2} \left( \frac{1}{0.01} \right)^2 \sim 0.021525 \quad (11.IX.a)$$

This mean that  $\frac{A^* P_0}{A P} \sim 0.1467$ . In the table it translate into

M	$\frac{T}{T_0}$	$\frac{\rho}{\rho_0}$	$\frac{A}{A^*}$	$\frac{P}{P_0}$	$\frac{A \times P}{A^* \times P_0}$	$\frac{F}{F^*}$
0.08486	0.99856	0.99641	6.8487	0.99497	6.8143	2.8679

---

End Solution

---

Table -11.1. Fliegner's number and other parameters as a function of Mach number

M	Fn	$\hat{\rho}$	$\left( \frac{P_0 A^*}{A P} \right)^2$	$\frac{RT_0}{P^2} \left( \frac{\dot{m}}{A} \right)^2$	$\frac{1}{R \rho_0 P} \left( \frac{\dot{m}}{A} \right)^2$	$\frac{1}{R \rho_0^2 T} \left( \frac{\dot{m}}{A} \right)^2$
0.00	1.4E-06	1.000	0.0	0.0	0.0	0.0
0.05	0.070106	1.000	0.00747	2.62E-05	0.00352	0.00351
0.10	0.14084	1.000	0.029920	0.000424	0.014268	0.014197

Table -11.1. Fliegner's number and other parameters as function of Mach number (continue)

M	Fn	$\hat{\rho}$	$\left(\frac{P_0 A^*}{AP}\right)^2$	$\frac{RT_0}{P^2} \left(\frac{\dot{m}}{A}\right)^2$	$\frac{1}{R\rho_0 P} \left(\frac{\dot{m}}{A}\right)^2$	$\frac{1}{R\rho_0^2 T} \left(\frac{\dot{m}}{A}\right)^2$
0.20	0.28677	1.001	0.12039	0.00707	0.060404	0.059212
0.21	0.30185	1.001	0.13284	0.00865	0.067111	0.065654
0.22	0.31703	1.001	0.14592	0.010476	0.074254	0.072487
0.23	0.33233	1.002	0.15963	0.012593	0.081847	0.079722
0.24	0.34775	1.002	0.17397	0.015027	0.089910	0.087372
0.25	0.36329	1.003	0.18896	0.017813	0.098460	0.095449
0.26	0.37896	1.003	0.20458	0.020986	0.10752	0.10397
0.27	0.39478	1.003	0.22085	0.024585	0.11710	0.11294
0.28	0.41073	1.004	0.23777	0.028651	0.12724	0.12239
0.29	0.42683	1.005	0.25535	0.033229	0.13796	0.13232
0.30	0.44309	1.005	0.27358	0.038365	0.14927	0.14276
0.31	0.45951	1.006	0.29247	0.044110	0.16121	0.15372
0.32	0.47609	1.007	0.31203	0.050518	0.17381	0.16522
0.33	0.49285	1.008	0.33226	0.057647	0.18709	0.17728
0.34	0.50978	1.009	0.35316	0.065557	0.20109	0.18992
0.35	0.52690	1.011	0.37474	0.074314	0.21584	0.20316
0.36	0.54422	1.012	0.39701	0.083989	0.23137	0.21703
0.37	0.56172	1.013	0.41997	0.094654	0.24773	0.23155
0.38	0.57944	1.015	0.44363	0.10639	0.26495	0.24674
0.39	0.59736	1.017	0.46798	0.11928	0.28307	0.26264
0.40	0.61550	1.019	0.49305	0.13342	0.30214	0.27926
0.41	0.63386	1.021	0.51882	0.14889	0.32220	0.29663
0.42	0.65246	1.023	0.54531	0.16581	0.34330	0.31480
0.43	0.67129	1.026	0.57253	0.18428	0.36550	0.33378
0.44	0.69036	1.028	0.60047	0.20442	0.38884	0.35361

Table -11.1. Fliegner's number and other parameters as function of Mach number (continue)

M	Fn	$\hat{\rho}$	$\left(\frac{P_0 A^*}{AP}\right)^2$	$\frac{RT_0}{P^2} \left(\frac{\dot{m}}{A}\right)^2$	$\frac{1}{R\rho_0 P} \left(\frac{\dot{m}}{A}\right)^2$	$\frac{1}{R\rho_0^2 T} \left(\frac{\dot{m}}{A}\right)^2$
0.45	0.70969	1.031	0.62915	0.22634	0.41338	0.37432
0.46	0.72927	1.035	0.65857	0.25018	0.43919	0.39596
0.47	0.74912	1.038	0.68875	0.27608	0.46633	0.41855
0.48	0.76924	1.042	0.71967	0.30418	0.49485	0.44215
0.49	0.78965	1.046	0.75136	0.33465	0.52485	0.46677
0.50	0.81034	1.050	0.78382	0.36764	0.55637	0.49249
0.51	0.83132	1.055	0.81706	0.40333	0.58952	0.51932
0.52	0.85261	1.060	0.85107	0.44192	0.62436	0.54733
0.53	0.87421	1.065	0.88588	0.48360	0.66098	0.57656
0.54	0.89613	1.071	0.92149	0.52858	0.69948	0.60706
0.55	0.91838	1.077	0.95791	0.57709	0.73995	0.63889
0.56	0.94096	1.083	0.99514	0.62936	0.78250	0.67210
0.57	0.96389	1.090	1.033	0.68565	0.82722	0.70675
0.58	0.98717	1.097	1.072	0.74624	0.87424	0.74290
0.59	1.011	1.105	1.112	0.81139	0.92366	0.78062
0.60	1.035	1.113	1.152	0.88142	0.97562	0.81996
0.61	1.059	1.122	1.194	0.95665	1.030	0.86101
0.62	1.084	1.131	1.236	1.037	1.088	0.90382
0.63	1.109	1.141	1.279	1.124	1.148	0.94848
0.64	1.135	1.151	1.323	1.217	1.212	0.99507
0.65	1.161	1.162	1.368	1.317	1.278	1.044
0.66	1.187	1.173	1.414	1.423	1.349	1.094
0.67	1.214	1.185	1.461	1.538	1.422	1.147
0.68	1.241	1.198	1.508	1.660	1.500	1.202
0.69	1.269	1.211	1.557	1.791	1.582	1.260

Table -11.1. Fliegner's number and other parameters as function of Mach number (continue)

M	Fn	$\hat{\rho}$	$\left(\frac{P_0 A^*}{AP}\right)^2$	$\frac{RT_0}{P^2} \left(\frac{\dot{m}}{A}\right)^2$	$\frac{1}{R\rho_0 P} \left(\frac{\dot{m}}{A}\right)^2$	$\frac{1}{R\rho_0^2 T} \left(\frac{\dot{m}}{A}\right)^2$
0.70	1.297	1.225	1.607	1.931	1.667	1.320
0.71	1.326	1.240	1.657	2.081	1.758	1.382
0.72	1.355	1.255	1.708	2.241	1.853	1.448
0.73	1.385	1.271	1.761	2.412	1.953	1.516
0.74	1.415	1.288	1.814	2.595	2.058	1.587
0.75	1.446	1.305	1.869	2.790	2.168	1.661
0.76	1.477	1.324	1.924	2.998	2.284	1.738
0.77	1.509	1.343	1.980	3.220	2.407	1.819
0.78	1.541	1.362	2.038	3.457	2.536	1.903
0.79	1.574	1.383	2.096	3.709	2.671	1.991
0.80	1.607	1.405	2.156	3.979	2.813	2.082
0.81	1.642	1.427	2.216	4.266	2.963	2.177
0.82	1.676	1.450	2.278	4.571	3.121	2.277
0.83	1.712	1.474	2.340	4.897	3.287	2.381
0.84	1.747	1.500	2.404	5.244	3.462	2.489
0.85	1.784	1.526	2.469	5.613	3.646	2.602
0.86	1.821	1.553	2.535	6.006	3.840	2.720
0.87	1.859	1.581	2.602	6.424	4.043	2.842
0.88	1.898	1.610	2.670	6.869	4.258	2.971
0.89	1.937	1.640	2.740	7.342	4.484	3.104
0.90	1.977	1.671	2.810	7.846	4.721	3.244
0.91	2.018	1.703	2.882	8.381	4.972	3.389
0.92	2.059	1.736	2.955	8.949	5.235	3.541
0.93	2.101	1.771	3.029	9.554	5.513	3.699
0.94	2.144	1.806	3.105	10.20	5.805	3.865

Table -11.1. Fliegner's number and other parameters as function of Mach number (continue)

M	Fn	$\hat{\rho}$	$\left(\frac{P_0 A^*}{AP}\right)^2$	$\frac{RT_0}{P^2} \left(\frac{\dot{m}}{A}\right)^2$	$\frac{1}{R\rho_0 P} \left(\frac{\dot{m}}{A}\right)^2$	$\frac{1}{R\rho_0^2 T} \left(\frac{\dot{m}}{A}\right)^2$
0.95	2.188	1.843	3.181	10.88	6.112	4.037
0.96	2.233	1.881	3.259	11.60	6.436	4.217
0.97	2.278	1.920	3.338	12.37	6.777	4.404
0.98	2.324	1.961	3.419	13.19	7.136	4.600
0.99	2.371	2.003	3.500	14.06	7.515	4.804
1.00	2.419	2.046	3.583	14.98	7.913	5.016

**Example 11.10:**

A gas flows in the tube with mass flow rate of 0.1 [kg/sec] and tube cross section is 0.001[m<sup>2</sup>]. The temperature at chamber supplying the pressure to tube is 27°C. At some point the static pressure was measured to be 1.5[Bar]. Calculate for that point the Mach number, the velocity, and the stagnation pressure. Assume that the process is isentropic,  $k = 1.3$ ,  $R = 287$ [j/kgK].

SOLUTION

The first thing that need to be done is to find the mass flow per area and it is

$$\frac{\dot{m}}{A} = 0.1/0.001 = 100.0[\text{kg}/\text{sec}/\text{m}^2]$$

It can be noticed that the total temperature is 300K and the static pressure is 1.5[Bar]. It is fortunate that Potto-GDC exist and it can be just plug into it and it provide that

M	$\frac{T}{T_0}$	$\frac{\rho}{\rho_0}$	$\frac{A}{A^*}$	$\frac{P}{P_0}$	$\frac{A \times P}{A^* \times P_0}$	$\frac{F}{F^*}$
0.17124	0.99562	0.98548	3.4757	0.98116	3.4102	1.5392

The velocity can be calculated as

$$U = M c = \sqrt{k R T} M = 0.17 \times \sqrt{1.3 \times 287 \times 300} \times \sim 56.87[\text{m}/\text{sec}]$$

The stagnation pressure is

$$P_0 = \frac{P}{P/P_0} = 1.5/0.98116 = 1.5288[\text{Bar}]$$

---

End Solution

**11.4.6 Isentropic Tables**

Table -11.2. Isentropic Table  $k = 1.4$ 

M	$\frac{T}{T_0}$	$\frac{\rho}{\rho_0}$	$\frac{A}{A^*}$	$\frac{P}{P_0}$	$\frac{A \times P}{A^* \times P_0}$	$\frac{F}{F^*}$
0.00	1.00000	1.00000	5.8E+5	1.0000	5.8E + 5	2.4E+5
0.05	0.99950	0.99875	11.59	0.99825	11.57	4.838
0.10	0.99800	0.99502	5.822	0.99303	5.781	2.443
0.20	0.99206	0.98028	2.964	0.97250	2.882	1.268
0.30	0.98232	0.95638	2.035	0.93947	1.912	0.89699
0.40	0.96899	0.92427	1.590	0.89561	1.424	0.72632
0.50	0.95238	0.88517	1.340	0.84302	1.130	0.63535
0.60	0.93284	0.84045	1.188	0.78400	0.93155	0.58377
0.70	0.91075	0.79158	1.094	0.72093	0.78896	0.55425
0.80	0.88652	0.73999	1.038	0.65602	0.68110	0.53807
0.90	0.86059	0.68704	1.009	0.59126	0.59650	0.53039
0.95	0.00328	1.061	1.002	1.044	0.95781	1.017
0.96	0.00206	1.049	1.001	1.035	0.96633	1.013
0.97	0.00113	1.036	1.001	1.026	0.97481	1.01
0.98	0.000495	1.024	1.0	1.017	0.98325	1.007
0.99	0.000121	1.012	1.0	1.008	0.99165	1.003
1.00	0.83333	0.63394	1.000	0.52828	0.52828	0.52828
1.1	0.80515	0.58170	1.008	0.46835	0.47207	0.52989
1.2	0.77640	0.53114	1.030	0.41238	0.42493	0.53399
1.3	0.74738	0.48290	1.066	0.36091	0.38484	0.53974
1.4	0.71839	0.43742	1.115	0.31424	0.35036	0.54655
1.5	0.68966	0.39498	1.176	0.27240	0.32039	0.55401
1.6	0.66138	0.35573	1.250	0.23527	0.29414	0.56182
1.7	0.63371	0.31969	1.338	0.20259	0.27099	0.56976
1.8	0.60680	0.28682	1.439	0.17404	0.25044	0.57768



Table -11.2. Isentropic Table  $k=1.4$  (continue)

M	$\frac{T}{T_0}$	$\frac{\rho}{\rho_0}$	$\frac{A}{A^*}$	$\frac{P}{P_0}$	$\frac{A \times P}{A^* \times P_0}$	$\frac{F}{F^*}$
1.9	0.58072	0.25699	1.555	0.14924	0.23211	0.58549
2.0	0.55556	0.23005	1.688	0.12780	0.21567	0.59309
2.5	0.44444	0.13169	2.637	0.058528	0.15432	0.62693
3.0	0.35714	0.076226	4.235	0.027224	0.11528	0.65326
3.5	0.28986	0.045233	6.790	0.013111	0.089018	0.67320
4.0	0.23810	0.027662	10.72	0.00659	0.070595	0.68830
4.5	0.19802	0.017449	16.56	0.00346	0.057227	0.69983
5.0	0.16667	0.011340	25.00	0.00189	0.047251	0.70876
5.5	0.14184	0.00758	36.87	0.00107	0.039628	0.71578
6.0	0.12195	0.00519	53.18	0.000633	0.033682	0.72136
6.5	0.10582	0.00364	75.13	0.000385	0.028962	0.72586
7.0	0.092593	0.00261	1.0E+2	0.000242	0.025156	0.72953
7.5	0.081633	0.00190	1.4E+2	0.000155	0.022046	0.73257
8.0	0.072464	0.00141	1.9E+2	0.000102	0.019473	0.73510
8.5	0.064725	0.00107	2.5E+2	6.90E-5	0.017321	0.73723
9.0	0.058140	0.000815	3.3E+2	4.74E-5	0.015504	0.73903
9.5	0.052493	0.000631	4.2E+2	3.31E-5	0.013957	0.74058
10.0	0.047619	0.000495	5.4E+2	2.36E-5	0.012628	0.74192

(Largest tables in the world can be found in Potto Gas Tables at [www.potto.org](http://www.potto.org))

### 11.4.7 The Impulse Function

One of the functions that is used in calculating the forces is the Impulse function. The Impulse function is denoted here as  $F$ , but in the literature some denote this function as  $I$ . To explain the motivation for using this definition consider the calculation of the net forces that acting on section shown in Figure (11.9). To calculate the net forces acting in

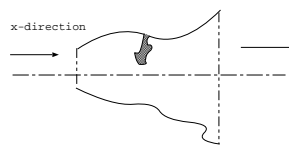

Fig. -11.9. Schematic to explain the significances of the Impulse function.

the  $x$ -direction the momentum equation has to be applied

$$F_{net} = \dot{m}(U_2 - U_1) + P_2A_2 - P_1A_1 \quad (11.62)$$

The net force is denoted here as  $F_{net}$ . The mass conservation also can be applied to our control volume

$$\dot{m} = \rho_1A_1U_1 = \rho_2A_2U_2 \quad (11.63)$$

Combining equation (11.62) with equation (11.63) and by utilizing the identity in equation (11.48) results in

$$F_{net} = kP_2A_2M_2^2 - kP_1A_1M_1^2 + P_2A_2 - P_1A_1 \quad (11.64)$$

Rearranging equation (11.64) and dividing it by  $P_0A^*$  results in

$$\frac{F_{net}}{P_0A^*} = \frac{\overbrace{P_2A_2}^{f(M_2)}}{P_0A^*} \frac{\overbrace{(1 + kM_2^2)}^{f(M_2)}}{(1 + kM_2^2)} - \frac{\overbrace{P_1A_1}^{f(M_1)}}{P_0A^*} \frac{\overbrace{(1 + kM_1^2)}^{f(M_1)}}{(1 + kM_1^2)} \quad (11.65)$$

Examining equation (11.65) shows that the right hand side is only a function of Mach number and specific heat ratio,  $k$ . Hence, if the right hand side is only a function of the Mach number and  $k$  than the left hand side must be function of only the same parameters,  $M$  and  $k$ . Defining a function that depends only on the Mach number creates the convenience for calculating the net forces acting on any device. Thus, defining the Impulse function as

$$F = PA(1 + kM^2) \quad (11.66)$$

In the Impulse function when  $F(M = 1)$  is denoted as  $F^*$

$$F^* = P^*A^*(1 + k) \quad (11.67)$$

The ratio of the Impulse function is defined as

$$\frac{F}{F^*} = \frac{P_1A_1}{P^*A^*} \frac{(1 + kM_1^2)}{(1 + k)} = \frac{1}{\underbrace{\frac{P_1}{P_0}}_{\left(\frac{2}{k+1}\right)^{\frac{k}{k-1}}}} \frac{\overbrace{P_1A_1}^{\text{see function (11.65)}}}{P_0A^*} \frac{1}{(1 + k)} \quad (11.68)$$

This ratio is different only in a coefficient from the ratio defined in equation (11.65) which makes the ratio a function of  $k$  and the Mach number. Hence, the net force is

$$F_{net} = P_0A^*(1 + k) \left(\frac{k + 1}{2}\right)^{\frac{k}{k-1}} \left(\frac{F_2}{F^*} - \frac{F_1}{F^*}\right) \quad (11.69)$$

To demonstrate the usefulness of the this function consider a simple situation of the flow through a converging nozzle.

Example 11.11:

Consider a flow of gas into a converging nozzle with a mass flow rate of  $1\text{[kg/sec]}$  and the entrance area is  $0.009\text{[m}^2\text{]}$  and the exit area is  $0.003\text{[m}^2\text{]}$ . The stagnation temperature is  $400\text{K}$  and the pressure at point 2 was measured as  $5\text{[Bar]}$ . Calculate the net force acting on the nozzle and pressure at point 1.

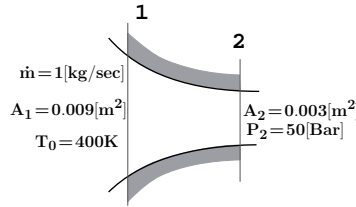

Fig. -11.10. Schematic of a flow of a compressible substance (gas) through a converging nozzle for example (11.11)

SOLUTION

The solution is obtained by getting the data for the Mach number. To obtain the Mach number, the ratio of  $P_1 A_1 / A^* P_0$  is needed to be calculated. To obtain this ratio the denominator is needed to be obtained. Utilizing Fliegner's equation (11.57), provides the following

$$A^* P_0 = \frac{\dot{m} \sqrt{RT}}{0.058} = \frac{1.0 \times \sqrt{400 \times 287}}{0.058} \sim 70061.76\text{[N]}$$

and

$$\frac{A_2 P_2}{A^* P_0} = \frac{500000 \times 0.003}{70061.76} \sim 2.1$$

M	$\frac{T}{T_0}$	$\frac{\rho}{\rho_0}$	$\frac{A}{A^*}$	$\frac{P}{P_0}$	$\frac{A \times P}{A^* \times P_0}$	$\frac{F}{F^*}$
0.27353	0.98526	0.96355	2.2121	0.94934	2.1000	0.96666

With the area ratio of  $\frac{A}{A^*} = 2.2121$  the area ratio of at point 1 can be calculated.

$$\frac{A_1}{A^*} = \frac{A_2}{A^*} \frac{A_1}{A_2} = 2.2121 \times \frac{0.009}{0.003} = 5.2227$$

And utilizing again Potto-GDC provides

M	$\frac{T}{T_0}$	$\frac{\rho}{\rho_0}$	$\frac{A}{A^*}$	$\frac{P}{P_0}$	$\frac{A \times P}{A^* \times P_0}$	$\frac{F}{F^*}$
0.11164	0.99751	0.99380	5.2227	0.99132	5.1774	2.1949

The pressure at point 1 is

$$P_1 = P_2 \frac{P_0}{P_2} \frac{P_1}{P_0} = 5.0 \times \frac{0.94934}{0.99380} \sim 4.776\text{[Bar]}$$

The net force is obtained by utilizing equation (11.69)

$$\begin{aligned}
 F_{net} &= P_2 A_2 \frac{P_0 A^*}{P_2 A_2} (1+k) \left( \frac{k+1}{2} \right)^{\frac{k}{k-1}} \left( \frac{F_2}{F^*} - \frac{F_1}{F^*} \right) \\
 &= 500000 \times \frac{1}{2.1} \times 2.4 \times 1.2^{3.5} \times (2.1949 - 0.96666) \sim 614 [kN]
 \end{aligned}$$

---

End Solution

---

## 11.5 Normal Shock

In this section the relationships between the two sides of normal shock are presented. In this discussion, the flow is assumed to be in a steady state, and the thickness of the shock is assumed to be very small. A shock can occur in at least two different mechanisms. The first is when a large difference (above a small minimum value) between the two sides of a membrane, and when the membrane bursts (see the discussion about the shock tube).

Of course, the shock travels from the high pressure

to the low pressure side. The second is when many sound waves “run into” each other and accumulate (some refer to it as “coalescing”) into a large difference, which is the shock wave. In fact, the sound wave can be viewed as an extremely weak shock. In the speed of sound analysis, it was assumed the medium is continuous, without any abrupt changes. This assumption is no longer valid in the case of a shock. Here, the relationship for a perfect gas is constructed.

In Figure 11.11 a control volume for this analysis is shown, and the gas flows from left to right. The conditions, to the left and to the right of the shock, are assumed to be uniform<sup>6</sup>. The conditions to the right of the shock wave are uniform, but different from the left side. The transition in the shock is abrupt and in a very narrow width. Therefore, the increase of the entropy is fundamental to the phenomenon and the understanding of it.

It is further assumed that there is no friction or heat loss at the shock (because the heat transfer is negligible due to the fact that it occurs on a relatively small surface). It is customary in this field to denote  $x$  as the upstream condition and  $y$  as the downstream condition.

The mass flow rate is constant from the two sides of the shock and therefore the mass balance is reduced to

$$\rho_x U_x = \rho_y U_y \quad (11.70)$$

---

<sup>6</sup>Clearly the change in the shock is so significant compared to the changes in medium before and after the shock that the changes in the mediums (flow) can be considered uniform.

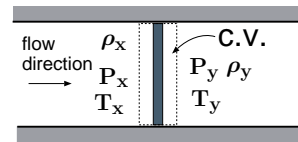

Fig. -11.11. A shock wave inside a tube, but it can also be viewed as a one-dimensional shock wave.

In a shock wave, the momentum is the quantity that remains constant because there are no external forces. Thus, it can be written that

$$P_x - P_y = (\rho_x U_y^2 - \rho_y U_x^2) \quad (11.71)$$

The process is adiabatic, or nearly adiabatic, and therefore the energy equation can be written as

$$C_p T_x + \frac{U_x^2}{2} = C_p T_y + \frac{U_y^2}{2} \quad (11.72)$$

The equation of state for perfect gas reads

$$P = \rho R T \quad (11.73)$$

If the conditions upstream are known, then there are four unknown conditions downstream. A system of four unknowns and four equations is solvable. Nevertheless, one can note that there are two solutions because of the quadratic of equation (11.72). These two possible solutions refer to the direction of the flow. Physics dictates that there is only one possible solution. One cannot deduce the direction of the flow from the pressure on both sides of the shock wave. The only tool that brings us to the direction of the flow is the second law of thermodynamics. This law dictates the direction of the flow, and as it will be shown, the gas flows from a supersonic flow to a subsonic flow. Mathematically, the second law is expressed by the entropy. For the adiabatic process, the entropy must increase. In mathematical terms, it can be written as follows:

$$s_y - s_x > 0 \quad (11.74)$$

Note that the greater-equal signs were not used. The reason is that the process is irreversible, and therefore no equality can exist. Mathematically, the parameters are  $P, T, U$ , and  $\rho$ , which are needed to be solved. For ideal gas, equation (11.74) is

$$\ln \left( \frac{T_y}{T_x} \right) - (k - 1) \frac{P_y}{P_x} > 0 \quad (11.75)$$

It can also be noticed that entropy,  $s$ , can be expressed as a function of the other parameters. These equations can be viewed as two different subsets of equations. The first set is the energy, continuity, and state equations, and the second set is the momentum, continuity, and state equations. The solution of every set of these equations produces one additional degree of freedom, which will produce a range of possible solutions. Thus, one can have a whole range of solutions. In the first case, the energy equation is used, producing various resistance to the flow. This case is called Fanno flow, and Section 11.7 deals extensively with this topic. Instead of solving all the equations that were presented, one can solve only four (4) equations (including the second law), which will require additional parameters. If the energy, continuity, and state equations are solved for the arbitrary value of the  $T_y$ , a parabola in the  $T - s$  diagram will be obtained. On the other hand, when the momentum equation is solved instead of the

energy equation, the degree of freedom is now energy, i.e., the energy amount “added” to the shock. This situation is similar to a frictionless flow with the addition of heat, and this flow is known as Rayleigh flow. This flow is dealt with in greater detail in Section (11.9).

Since the shock has no heat transfer (a special case of Rayleigh flow) and there isn't essentially any momentum transfer (a special case of Fanno flow), the intersection of these two curves is what really happened in the shock. The entropy increases from point  $x$  to point  $y$ .

### 11.5.1 Solution of the Governing Equations

Equations (11.70), (11.71), and (11.72) can be converted into a dimensionless form. The reason that dimensionless forms are heavily used in this book is because by doing so it simplifies and clarifies the solution. It can also be noted that in many cases the dimensionless equations set is more easily solved.

From the continuity equation (11.70) substituting for density,  $\rho$ , the equation of state yields

$$\frac{P_x}{RT_x} U_x = \frac{P_y}{RT_y} U_y \quad (11.76)$$

Squaring equation (11.76) results in

$$\frac{P_x^2}{R^2 T_x^2} U_x^2 = \frac{P_y^2}{R^2 T_y^2} U_y^2 \quad (11.77)$$

Multiplying the two sides by the ratio of the specific heat,  $k$ , provides a way to obtain the speed of sound definition/equation for perfect gas,  $c^2 = kRT$  to be used for the Mach number definition, as follows:

$$\frac{P_x^2}{T_x \underbrace{kRT_x}_{c_x^2}} U_x^2 = \frac{P_y^2}{T_y \underbrace{kRT_y}_{c_y^2}} U_y^2 \quad (11.78)$$

Note that the speed of sound is different on the sides of the shock. Utilizing the definition of Mach number results in

$$\frac{P_x^2}{T_x} M_x^2 = \frac{P_y^2}{T_y} M_y^2 \quad (11.79)$$

Rearranging equation (11.79) results in

$$\frac{T_y}{T_x} = \left( \frac{P_y}{P_x} \right)^2 \left( \frac{M_y}{M_x} \right)^2 \quad (11.80)$$

Energy equation (11.72) can be converted to a dimensionless form which can be expressed as

$$T_y \left( 1 + \frac{k-1}{2} M_y^2 \right) = T_x \left( 1 + \frac{k-1}{2} M_x^2 \right) \quad (11.81)$$

It can also be observed that equation (11.81) means that the stagnation temperature is the same,  $T_{0y} = T_{0x}$ . Under the perfect gas model,  $\rho U^2$  is identical to  $k P M^2$  because

$$\rho U^2 = \frac{\overbrace{P}^{\rho}}{RT} \left( \overbrace{\frac{U^2}{k RT}}^{M^2} \right) k RT = k P M^2 \quad (11.82)$$

Using the identity (11.82) transforms the momentum equation (11.71) into

$$P_x + k P_x M_x^2 = P_y + k P_y M_y^2 \quad (11.83)$$

Rearranging equation (11.83) yields

$$\frac{P_y}{P_x} = \frac{1 + k M_x^2}{1 + k M_y^2} \quad (11.84)$$

The pressure ratio in equation (11.84) can be interpreted as the loss of the static pressure. The loss of the total pressure ratio can be expressed by utilizing the relationship between the pressure and total pressure (see equation (11.27)) as

$$\frac{P_{0y}}{P_{0x}} = \frac{P_y \left( 1 + \frac{k-1}{2} M_y^2 \right)^{\frac{k}{k-1}}}{P_x \left( 1 + \frac{k-1}{2} M_x^2 \right)^{\frac{k}{k-1}}} \quad (11.85)$$

The relationship between  $M_x$  and  $M_y$  is needed to be solved from the above set of equations. This relationship can be obtained from the combination of mass, momentum, and energy equations. From equation (11.81) (energy) and equation (11.80) (mass) the temperature ratio can be eliminated.

$$\left( \frac{P_y M_y}{P_x M_x} \right)^2 = \frac{1 + \frac{k-1}{2} M_x^2}{1 + \frac{k-1}{2} M_y^2} \quad (11.86)$$

Combining the results of (11.86) with equation (11.84) results in

$$\left(\frac{1+kM_x^2}{1+kM_y^2}\right)^2 = \left(\frac{M_x}{M_y}\right)^2 \frac{1+\frac{k-1}{2}M_x^2}{1+\frac{k-1}{2}M_y^2} \quad (11.87)$$

Equation (11.87) is a symmetrical equation in the sense that if  $M_y$  is substituted with  $M_x$  and  $M_x$  substituted with  $M_y$  the equation remains the same. Thus, one solution is

$$M_y = M_x \quad (11.88)$$

It can be observed that equation (11.87) is biquadratic. According to the Gauss Biquadratic Reciprocity Theorem this kind of equation has a real solution in a certain range<sup>7</sup> which will be discussed later. The solution can be obtained by rewriting equation (11.87) as a polynomial (fourth order). It is also possible to cross-multiply equation (11.87) and divide it by  $(M_x^2 - M_y^2)$  results in

$$1 + \frac{k-1}{2}(M_y^2 + M_x^2) - kM_y^2M_x^2 = 0 \quad (11.89)$$

Equation (11.89) becomes

Shock Solution

$$M_y^2 = \frac{M_x^2 + \frac{2}{k-1}}{\frac{2k}{k-1}M_x^2 - 1} \quad (11.90)$$

The first solution (11.88) is the trivial solution in which the two sides are identical and no shock wave occurs. Clearly, in this case, the pressure and the temperature from both sides of the nonexistent shock are the same, i.e.  $T_x = T_y$ ,  $P_x = P_y$ . The second solution is where the shock wave occurs.

The pressure ratio between the two sides can now be as a function of only a single Mach number, for example,  $M_x$ . Utilizing equation (11.84) and equation (11.90) provides the pressure ratio as only a function of the upstream Mach number as

$$\frac{P_y}{P_x} = \frac{2k}{k+1}M_x^2 - \frac{k-1}{k+1} \quad \text{or}$$

Shock Pressure Ratio

$$\frac{P_y}{P_x} = 1 + \frac{2k}{k+1}(M_x^2 - 1) \quad (11.91)$$

<sup>7</sup>Ireland, K. and Rosen, M. "Cubic and Biquadratic Reciprocity." Ch. 9 in A Classical Introduction to Modern Number Theory, 2nd ed. New York: Springer-Verlag, pp. 108-137, 1990.



The density and upstream Mach number relationship can be obtained in the same fashion to become

$$\frac{\rho_y}{\rho_x} = \frac{U_x}{U_y} = \frac{(k+1)M_x^2}{2 + (k-1)M_x^2} \quad (11.92)$$

The fact that the pressure ratio is a function of the upstream Mach number,  $M_x$ , provides additional way of obtaining an additional useful relationship. And the temperature ratio, as a function of pressure ratio, is transformed into

$$\frac{T_y}{T_x} = \left(\frac{P_y}{P_x}\right) \left( \frac{\frac{k+1}{k-1} + \frac{P_y}{P_x}}{1 + \frac{k+1}{k-1} \frac{P_y}{P_x}} \right) \quad (11.93)$$

In the same way, the relationship between the density ratio and pressure ratio is

$$\frac{\rho_x}{\rho_y} = \frac{1 + \left(\frac{k+1}{k-1}\right) \left(\frac{P_y}{P_x}\right)}{\left(\frac{k+1}{k-1}\right) + \left(\frac{P_y}{P_x}\right)} \quad (11.94)$$

which is associated with the shock wave.

### 11.5.1.1 The Star Conditions

The speed of sound at the critical condition can also be a good reference velocity. The speed of sound at that velocity is

$$c^* = \sqrt{kRT^*} \quad (11.95)$$

In the same manner, an additional Mach number can be defined as

$$M^* = \frac{U}{c^*} \quad (11.96)$$

### 11.5.2 Prandtl's Condition

It can be easily observed that the temperature from both sides of the shock wave is discontinuous. Therefore, the speed of sound is different in these adjoining mediums. It is therefore convenient to define the star Mach number that will be independent of the specific Mach number (independent of the temperature).

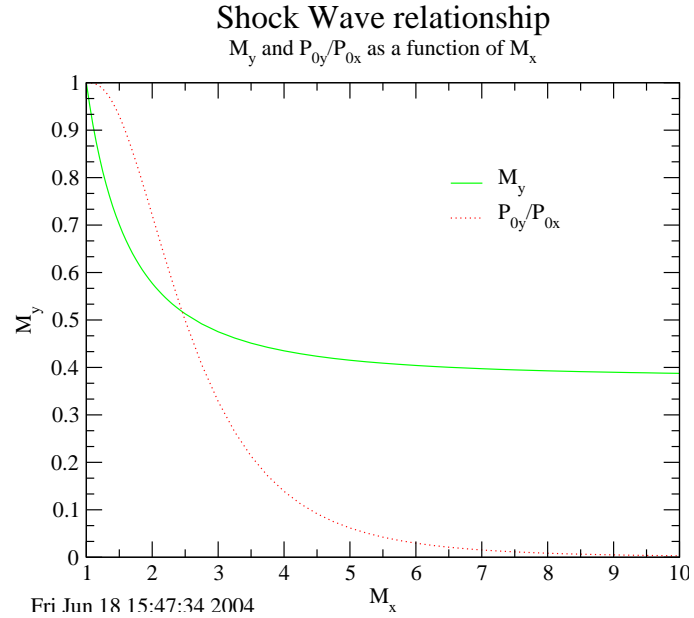

Fig. -11.12. The exit Mach number and the stagnation pressure ratio as a function of upstream Mach number.

$$M^* = \frac{U}{c^*} = \frac{c}{c^*} \frac{U}{c} = \frac{c}{c^*} M \quad (11.97)$$

The jump condition across the shock must satisfy the constant energy.

$$\frac{c^2}{k-1} + \frac{U^2}{2} = \frac{c^{*2}}{k-1} + \frac{c^{*2}}{2} = \frac{k+1}{2(k-1)} c^{*2} \quad (11.98)$$

Dividing the mass equation by the momentum equation and combining it with the perfect gas model yields

$$\frac{c_1^2}{kU_1} + U_1 = \frac{c_2^2}{kU_2} + U_2 \quad (11.99)$$

Combining equation (11.98) and (11.99) results in

$$\frac{1}{kU_1} \left[ \frac{k+1}{2} c^{*2} - \frac{k-1}{2} U_1 \right] + U_1 = \frac{1}{kU_2} \left[ \frac{k+1}{2} c^{*2} - \frac{k-1}{2} U_2 \right] + U_2 \quad (11.100)$$

After rearranging and dividing equation (11.100) the following can be obtained:

$$U_1 U_2 = c^{*2} \quad (11.101)$$

or in a dimensionless form

$$M^*_1 M^*_2 = c^{*2} \tag{11.102}$$

### 11.5.3 Operating Equations and Analysis

In Figure 11.12, the Mach number after the shock,  $M_y$ , and the ratio of the total pressure,  $P_{0y}/P_{0x}$ , are plotted as a function of the entrance Mach number. The working equations were presented earlier. Note that the  $M_y$  has a minimum value which depends on the specific heat ratio. It can be noticed that the density ratio (velocity ratio) also has a finite value regardless of the upstream Mach number.

The typical situations in which these equations can be used also include the moving shocks. The equations should be used with the Mach number (upstream or downstream) for a given pressure ratio or density ratio (velocity ratio). This kind of equations requires examining Table (11.3) for  $k = 1.4$  or utilizing Potto-GDC for for value of the specific heat ratio. Finding the Mach number for a pressure ratio of 8.30879 and  $k = 1.32$  and is only a few mouse clicks away from the following table.

To illustrate the use of the above equations, an example is provided.

**Example 11.12:**

Air flows with a Mach number of  $M_x = 3$ , at a pressure of 0.5 [bar] and a temperature of 0° C goes through a normal shock. Calculate the temperature, pressure, total pressure, and velocity downstream of the shock. Assume that  $k = 1.4$ .

SOLUTION

**Analysis:**

First, the known information are  $M_x = 3$ ,  $P_x = 1.5[bar]$  and  $T_x = 273K$ . Using these data, the total pressure can be obtained (through an isentropic relationship in Table (11.2), i.e.,  $P_{0x}$  is known). Also with the temperature,  $T_x$ , the velocity can readily be calculated. The relationship that was calculated will be utilized to obtain the ratios for the downstream of the normal shock.  $\frac{P_x}{P_{0x}} = 0.0272237 \implies P_{0x} = 1.5/0.0272237 = 55.1[bar]$

$$c_x = \sqrt{k R T_x} = \sqrt{1.4 \times 287 \times 273} = 331.2m/sec$$

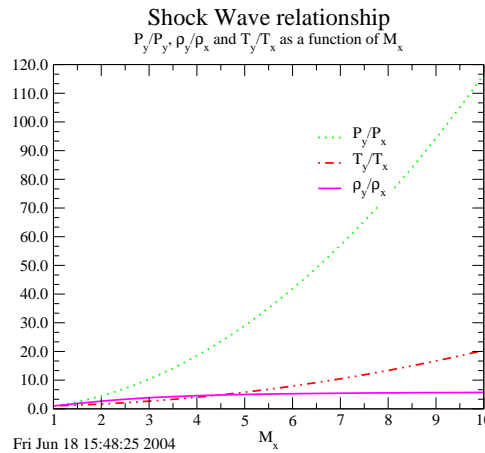

Fig. -11.13. The ratios of the static properties of the two sides of the shock.

$M_x$	$M_y$	$\frac{T_y}{T_x}$	$\frac{\rho_y}{\rho_x}$	$\frac{P_y}{P_x}$	$\frac{P_{0y}}{P_{0x}}$
3.0000	0.47519	2.6790	3.8571	10.3333	0.32834

$$U_x = M_x \times c_x = 3 \times 331.2 = 993.6[m/sec]$$

Now the velocity downstream is determined by the inverse ratio of  $\rho_y/\rho_x = U_x/U_y = 3.85714$ .

$$U_y = 993.6/3.85714 = 257.6[m/sec]$$

$$P_{0y} = \left( \frac{P_{0y}}{P_{0x}} \right) \times P_{0x} = 0.32834 \times 55.1[bar] = 18.09[bar]$$

---

End Solution

---

When the upstream Mach number becomes very large, the downstream Mach number (see equation (11.90)) is limited by

$$M_y^2 = \frac{1 + \frac{2}{(k-1)M_x^2} \xrightarrow{\sim 0}}{\frac{2k}{k-1} - \frac{1}{M_x^2} \xrightarrow{\sim 0}} = \frac{k-1}{2k} \quad (11.103)$$

This result is shown in Figure 11.12. The limits of the pressure ratio can be obtained by looking at equation (11.84) and by utilizing the limit that was obtained in equation (11.103).

### 11.5.4 The Moving Shocks

In some situations, the shock wave is not stationary. This kind of situation arises in many industrial applications. For example, when a valve is suddenly <sup>8</sup> closed and a shock propagates upstream. On the other extreme, when a valve is suddenly opened or a membrane is ruptured, a shock occurs and propagates downstream (the opposite direction of the previous case). In addition to (partially) closing or (partially) opening of valve, the rigid body (not so rigid body) movement creates shocks. In some industrial applications, a liquid (metal) is pushed in two rapid stages to a cavity through a pipe system. This liquid (metal) is pushing gas (mostly) air, which creates two shock stages. The moving shock is observed by daily as hearing sound wave are moving shocks.

As a general rule, the moving shock can move downstream or upstream. The source of the shock creation, either due to the static device operation like valve operating/closing or due to moving object, is relevant to analysis but it effects the boundary conditions. This creation difference while creates the same moving shock it creates different questions and hence in some situations complicate the calculations. The most general case which this section will be dealing with is the partially open or close wave. A brief discussion on the such case (partially close/open but due the moving object) will be presented. There are more general cases where the moving shocks are created which include a change in the physical properties, but this book will not deal with them at this stage. The reluctance to deal with the most general case is due to fact it is highly specialized and complicated even beyond early graduate students level. In these changes (of opening a valve and closing a valve on the other side) create situations in

<sup>8</sup>It will be explained using dimensional analysis what is suddenly open.

which different shocks are moving in the tube. The general case is where two shocks collide into one shock and moves upstream or downstream is the general case. A specific example is common in die-casting: after the first shock moves a second shock is created in which its velocity is dictated by the upstream and downstream velocities.

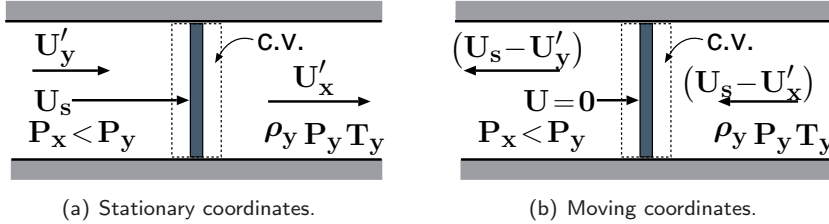

Fig. -11.14. Comparison between stationary and moving coordinates for the moving shock.

In cases where the shock velocity can be approximated as a constant (in the majority of cases) or as near constant, the previous analysis, equations, and the tools developed in this chapter can be employed. The problem can be reduced to the previously studied shock, i.e., to the stationary case when the coordinates are attached to the shock front. In such a case, the steady state is obtained in the moving control value.

For this analysis, the coordinates move with the shock. Here, the prime ' denotes the values of the static coordinates. Note that this notation is contrary to the conventional notation found in the literature. The reason for the deviation is that this choice reduces the programming work (especially for object-oriented programming like C++). An observer moving with the shock will notice that the pressure in the shock sides is

$$P_x' = P_x \quad P_y' = P_y \tag{11.104}$$

The temperatures measured by the observer are

$$T_x' = T_x \quad T_y' = T_y \tag{11.105}$$

Assuming that the shock is moving to the right, (refer to Figure 11.14) the velocity measured by the observer is

$$U_x = U_s - U_x' \tag{11.106}$$

Where  $U_s$  is the shock velocity which is moving to the right. The “downstream” velocity is

$$U_y' = U_s - U_y \tag{11.107}$$

The speed of sound on both sides of the shock depends only on the temperature and it is assumed to be constant. The upstream prime Mach number can be defined as

$$M_x' = \frac{U_s - U_x}{c_x} = \frac{U_s}{c_x} - M_x = M_{sx} - M_x \tag{11.108}$$

It can be noted that the additional definition was introduced for the shock upstream Mach number,  $M_{sx} = \frac{U_s}{c_x}$ . The downstream prime Mach number can be expressed as

$$M_y' = \frac{U_s - U_y}{c_y} = \frac{U_s}{c_y} - M_y = M_{sy} - M_y \quad (11.109)$$

Similar to the previous case, an additional definition was introduced for the shock downstream Mach number,  $M_{sy}$ . The relationship between the two new shock Mach numbers is

$$\frac{U_s}{c_x} = \frac{c_y}{c_x} \frac{U_s}{c_y} \quad (11.110)$$

$$M_{sx} = \sqrt{\frac{T_y}{T_x}} M_{sy}$$

The “upstream” stagnation temperature of the fluid is

Shock Stagnation Temperature

$$T_{0x} = T_x \left( 1 + \frac{k-1}{2} M_x^2 \right) \quad (11.111)$$

and the “upstream” prime stagnation pressure is

$$P_{0x} = P_x \left( 1 + \frac{k-1}{2} M_x^2 \right)^{\frac{k}{k-1}} \quad (11.112)$$

The same can be said for the “downstream” side of the shock. The difference between the stagnation temperature is in the moving coordinates

$$T_{0y} - T_{0x} = 0 \quad (11.113)$$

### 11.5.5 Shock or Wave Drag Result from a Moving Shock

It can be shown that there is no shock drag in stationary shock for more information see “Fundamentals of Compressible Flow, Potto Project, Bar-Meir any version”.. However, the shock or wave drag is very significant so much so that at one point it was considered the sound barrier. Consider the figure (11.15) where the stream lines are moving with the object speed. The other boundaries are stationary but the velocity at right boundary is not zero. The same arguments, as discussed before in the stationary case, are applied. What

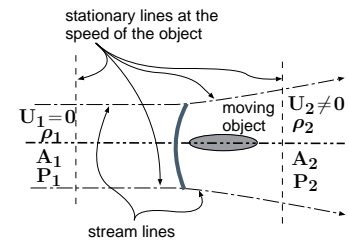

Fig. -11.15. The diagram that reexplains the shock drag effect of a moving shock.

is different in the present case (as oppose to the stationary shock), one side has increase the momentum of the control volume. This increase momentum in the control volume causes the shock drag. In way, it can be view as continuous acceleration of the gas around the body from zero. Note this drag is only applicable to a moving shock (unsteady shock).

The moving shock is either results from a body that moves in gas or from a sudden imposed boundary like close or open valve<sup>9</sup>. In the first case, the forces or energies flow from body to gas and therefor there is a need for large force to accelerate the gas over extremely short distance (shock thickness). In the second case, the gas contains the energy (as high pressure, for example in the open valve case) and the energy potential is lost in the shock process (like shock drag).

For some strange reasons, this topic has several misconceptions that even appear in many popular and good textbooks<sup>10</sup>. Consider the following example taken from such a book.

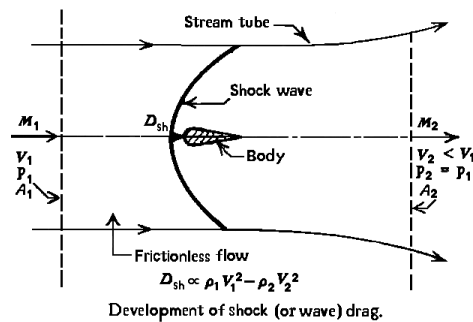

Fig. -11.16. The diagram for the common explanation for shock or wave drag effect a shock. Please notice the strange notations (e.g.  $V$  and not  $U$ ) and they result from a verbatim copy.

#### Example 11.13:

A book (see Figure 11.16) explains the shock drag is based on the following rational: The body is moving in a stationary frictionless fluid under one-dimensional flow. The left plane is moving with body at the same speed. The second plane is located "downstream from the body where the gas has expanded isotropically (after the shock wave) to the upstream static pressure". the bottom and upper stream line close the control volume. Since the pressure is the same on the both planes there is no unbalanced pressure forces. However, there is a change in the momentum in the flow direction because  $U_1 > U_2$ . The force is acting on the body. There several mistakes in this explanation including

<sup>9</sup>According to my son, the difference between these two cases is the direction of the information. Both case there essentially bodies, however, in one the information flows from inside the field to the boundary while the other case it is the opposite.

<sup>10</sup>Similar situation exist in the surface tension area.

the drawing. Explain what is wrong in this description (do not describe the error results from oblique shock).

#### SOLUTION

Neglecting the mistake around the contact of the stream lines with the oblique shock (see for retouch in the oblique chapter), the control volume suggested is stretched with time. However, the common explanation fall to notice that when the isentropic expansion occurs the width of the area change. Thus, the simple explanation in a change only in momentum (velocity) is not appropriate. Moreover, in an expanding control volume this simple explanation is not appropriate. Notice that the relative velocity at the front of the control volume  $U_1$  is actually zero. Hence, the claim of  $U_1 > U_2$  is actually the opposite,  $U_1 < U_2$ .

---

End Solution

---

### Supplemental Problems

1. In the analysis of the maximum temperature in the shock tube, it was assumed that process is isentropic. If this assumption is not correct would the maximum temperature obtained is increased or decreased?
2. In the analysis of the maximum temperature in the shock wave it was assumed that process is isentropic. Clearly, this assumption is violated when there are shock waves. In that cases, what is the reasoning behind use this assumption any why?

### 11.5.6 Tables of Normal Shocks, $k = 1.4$ Ideal Gas

---

Table -11.3. The shock wave table for  $k = 1.4$

$M_x$	$M_y$	$\frac{T_y}{T_x}$	$\frac{\rho_y}{\rho_x}$	$\frac{P_y}{P_x}$	$\frac{P_{0y}}{P_{0x}}$
1.00	1.00000	1.00000	1.00000	1.00000	1.00000
1.05	0.95313	1.03284	1.08398	1.11958	0.99985
1.10	0.91177	1.06494	1.16908	1.24500	0.99893
1.15	0.87502	1.09658	1.25504	1.37625	0.99669
1.20	0.84217	1.12799	1.34161	1.51333	0.99280
1.25	0.81264	1.15938	1.42857	1.65625	0.98706
1.30	0.78596	1.19087	1.51570	1.80500	0.97937
1.35	0.76175	1.22261	1.60278	1.95958	0.96974



Table -11.3. The shock wave table for  $k = 1.4$  (continue)

$M_x$	$M_y$	$\frac{T_y}{T_x}$	$\frac{\rho_y}{\rho_x}$	$\frac{P_y}{P_x}$	$\frac{P_{0y}}{P_{0x}}$
1.40	0.73971	1.25469	1.68966	2.12000	0.95819
1.45	0.71956	1.28720	1.77614	2.28625	0.94484
1.50	0.70109	1.32022	1.86207	2.45833	0.92979
1.55	0.68410	1.35379	1.94732	2.63625	0.91319
1.60	0.66844	1.38797	2.03175	2.82000	0.89520
1.65	0.65396	1.42280	2.11525	3.00958	0.87599
1.70	0.64054	1.45833	2.19772	3.20500	0.85572
1.75	0.62809	1.49458	2.27907	3.40625	0.83457
1.80	0.61650	1.53158	2.35922	3.61333	0.81268
1.85	0.60570	1.56935	2.43811	3.82625	0.79023
1.90	0.59562	1.60792	2.51568	4.04500	0.76736
1.95	0.58618	1.64729	2.59188	4.26958	0.74420
2.00	0.57735	1.68750	2.66667	4.50000	0.72087
2.05	0.56906	1.72855	2.74002	4.73625	0.69751
2.10	0.56128	1.77045	2.81190	4.97833	0.67420
2.15	0.55395	1.81322	2.88231	5.22625	0.65105
2.20	0.54706	1.85686	2.95122	5.48000	0.62814
2.25	0.54055	1.90138	3.01863	5.73958	0.60553
2.30	0.53441	1.94680	3.08455	6.00500	0.58329
2.35	0.52861	1.99311	3.14897	6.27625	0.56148
2.40	0.52312	2.04033	3.21190	6.55333	0.54014
2.45	0.51792	2.08846	3.27335	6.83625	0.51931
2.50	0.51299	2.13750	3.33333	7.12500	0.49901
2.75	0.49181	2.39657	3.61194	8.65625	0.40623
3.00	0.47519	2.67901	3.85714	10.33333	0.32834

Table -11.3. The shock wave table for  $k = 1.4$  (continue)

$M_x$	$M_y$	$\frac{T_y}{T_x}$	$\frac{\rho_y}{\rho_x}$	$\frac{P_y}{P_x}$	$\frac{P_{0y}}{P_{0x}}$
3.25	0.46192	2.98511	4.07229	12.15625	0.26451
3.50	0.45115	3.31505	4.26087	14.12500	0.21295
3.75	0.44231	3.66894	4.42623	16.23958	0.17166
4.00	0.43496	4.04688	4.57143	18.50000	0.13876
4.25	0.42878	4.44891	4.69919	20.90625	0.11256
4.50	0.42355	4.87509	4.81188	23.45833	0.09170
4.75	0.41908	5.32544	4.91156	26.15625	0.07505
5.00	0.41523	5.80000	5.00000	29.00000	0.06172
5.25	0.41189	6.29878	5.07869	31.98958	0.05100
5.50	0.40897	6.82180	5.14894	35.12500	0.04236
5.75	0.40642	7.36906	5.21182	38.40625	0.03536
6.00	0.40416	7.94059	5.26829	41.83333	0.02965
6.25	0.40216	8.53637	5.31915	45.40625	0.02498
6.50	0.40038	9.15643	5.36508	49.12500	0.02115
6.75	0.39879	9.80077	5.40667	52.98958	0.01798
7.00	0.39736	10.46939	5.44444	57.00000	0.01535
7.25	0.39607	11.16229	5.47883	61.15625	0.01316
7.50	0.39491	11.87948	5.51020	65.45833	0.01133
7.75	0.39385	12.62095	5.53890	69.90625	0.00979
8.00	0.39289	13.38672	5.56522	74.50000	0.00849
8.25	0.39201	14.17678	5.58939	79.23958	0.00739
8.50	0.39121	14.99113	5.61165	84.12500	0.00645
8.75	0.39048	15.82978	5.63218	89.15625	0.00565
9.00	0.38980	16.69273	5.65116	94.33333	0.00496
9.25	0.38918	17.57997	5.66874	99.65625	0.00437

Table -11.3. The shock wave table for  $k = 1.4$  (continue)

$M_x$	$M_y$	$\frac{T_y}{T_x}$	$\frac{\rho_y}{\rho_x}$	$\frac{P_y}{P_x}$	$\frac{P_{0y}}{P_{0x}}$
9.50	0.38860	18.49152	5.68504	105.12500	0.00387
9.75	0.38807	19.42736	5.70019	110.73958	0.00343
10.00	0.38758	20.38750	5.71429	116.50000	0.00304

### 11.6 Isothermal Flow

In this section a model dealing with gas that flows through a long tube is described. This model has a applicability to situations which occur in a relatively long distance and where heat transfer is relatively rapid so that the temperature can be treated, for engineering purposes, as a constant. For example, this model is applicable when a natural gas flows over several hundreds of meters. Such situations are common in large cities in U.S.A. where natural gas is used for heating. It is more predominant (more applicable) in situations where the gas is pumped over a length of kilometers.

The high speed of the gas is obtained or explained by the combination of heat transfer and the friction to the flow. For a long pipe, the pressure difference reduces the density of the gas. For instance, in a perfect gas, the density is inverse of the pressure (it has to be kept in mind that the gas undergoes an isothermal process.). To maintain conservation of mass, the velocity increases inversely to the pressure. At critical point the velocity reaches the speed of sound at the exit and hence the flow will be choked<sup>11</sup>.

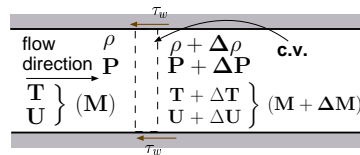

Fig. -11.17. Control volume for isothermal flow.

#### 11.6.1 The Control Volume Analysis/Governing equations

Figure (11.17) describes the flow of gas from the left to the right. The heat transfer up stream (or down stream) is assumed to be negligible. Hence, the energy equation can be written as the following:

$$\frac{dQ}{\dot{m}} = c_p dT + d\frac{U^2}{2} = c_p dT_0 \tag{11.114}$$

<sup>11</sup>This explanation is not correct as it will be shown later on. Close to the critical point (about,  $1/\sqrt{k}$ , the heat transfer, is relatively high and the isothermal flow model is not valid anymore. Therefore, the study of the isothermal flow above this point is only an academic discussion but also provides the upper limit for Fanno Flow.

The momentum equation is written as the following

$$-A dP - \tau_w dA_{\text{wetted area}} = \dot{m} dU \quad (11.115)$$

where  $A$  is the cross section area (it doesn't have to be a perfect circle; a close enough shape is sufficient.). The shear stress is the force per area that acts on the fluid by the tube wall. The  $A_{\text{wetted area}}$  is the area that shear stress acts on. The second law of thermodynamics reads

$$\frac{s_2 - s_1}{C_p} = \ln \frac{T_2}{T_1} - \frac{k-1}{k} \ln \frac{P_2}{P_1} \quad (11.116)$$

The mass conservation is reduced to

$$\dot{m} = \text{constant} = \rho U A \quad (11.117)$$

Again it is assumed that the gas is a perfect gas and therefore, equation of state is expressed as the following:

$$P = \rho R T \quad (11.118)$$

### 11.6.2 Dimensionless Representation

In this section the equations are transformed into the dimensionless form and presented as such. First it must be recalled that the temperature is constant and therefore, equation of state reads

$$\frac{dP}{P} = \frac{d\rho}{\rho} \quad (11.119)$$

It is convenient to define a hydraulic diameter

$$D_H = \frac{4 \times \text{Cross Section Area}}{\text{wetted perimeter}} \quad (11.120)$$

The Fanning friction factor<sup>12</sup> is introduced, this factor is a dimensionless friction factor sometimes referred to as the friction coefficient as

$$f = \frac{\tau_w}{\frac{1}{2}\rho U^2} \quad (11.121)$$

Substituting equation (11.121) into momentum equation (11.115) yields

$$-dP - \frac{4 dx}{D_H} f \left( \frac{1}{2} \rho U^2 \right) = \overbrace{\rho U}^{\frac{\dot{m}}{A}} dU \quad (11.122)$$

<sup>12</sup>It should be noted that Fanning factor based on hydraulic radius, instead of diameter friction equation, thus "Fanning  $f$ " values are only 1/4th of "Darcy  $f$ " values.

Rearranging equation (11.122) and using the identity for perfect gas  $M^2 = \rho U^2 / kP$  yields:

$$-\frac{dP}{P} - \frac{4f dx}{D_H} \left( \frac{k P M^2}{2} \right) = \frac{k P M^2 dU}{U} \quad (11.123)$$

The pressure,  $P$  as a function of the Mach number has to substitute along with velocity,  $U$  as

$$U^2 = k R T M^2 \quad (11.124)$$

Differentiation of equation (11.124) yields

$$d(U^2) = k R (M^2 dT + T d(M^2)) \quad (11.125)$$

$$\frac{d(M^2)}{M^2} = \frac{d(U^2)}{U^2} - \frac{dT}{T} \quad (11.126)$$

It can be noticed that  $dT = 0$  for isothermal process and therefore

$$\frac{d(M^2)}{M^2} = \frac{d(U^2)}{U^2} = \frac{2U dU}{U^2} = \frac{2dU}{U} \quad (11.127)$$

The dimensionalization of the mass conservation equation yields

$$\frac{d\rho}{\rho} + \frac{dU}{U} = \frac{d\rho}{\rho} + \frac{2U dU}{2U^2} = \frac{d\rho}{\rho} + \frac{d(U^2)}{2U^2} = 0 \quad (11.128)$$

Differentiation of the isotropic (stagnation) relationship of the pressure (11.27) yields

$$\frac{dP_0}{P_0} = \frac{dP}{P} + \left( \frac{\frac{k M^2}{2}}{1 + \frac{k-1}{2} M^2} \right) \frac{dM^2}{M^2} \quad (11.129)$$

Differentiation of equation (11.25) yields:

$$dT_0 = dT \left( 1 + \frac{k-1}{2} M^2 \right) + T \frac{k-1}{2} dM^2 \quad (11.130)$$

Notice that  $dT_0 \neq 0$  in an isothermal flow. There is no change in the actual temperature of the flow but the stagnation temperature increases or decreases depending on the Mach number (supersonic flow or subsonic flow). Substituting  $T$  for equation (11.130) yields:

$$dT_0 = \frac{T_0 \frac{k-1}{2} dM^2}{\left( 1 + \frac{k-1}{2} M^2 \right)} \frac{M^2}{M^2} \quad (11.131)$$

Rearranging equation (11.131) yields

$$\frac{dT_0}{T_0} = \frac{(k-1) M^2}{2 \left(1 + \frac{k-1}{2}\right)} \frac{dM^2}{M^2} \quad (11.132)$$

By utilizing the momentum equation it is possible to obtain a relation between the pressure and density. Recalling that an isothermal flow ( $dT = 0$ ) and combining it with perfect gas model yields

$$\frac{dP}{P} = \frac{d\rho}{\rho} \quad (11.133)$$

From the continuity equation (see equation (11.127)) leads

$$\frac{dM^2}{M^2} = \frac{2dU}{U} \quad (11.134)$$

The four equations momentum, continuity (mass), energy, state are described above. There are 4 unknowns ( $M, T, P, \rho$ )<sup>13</sup> and with these four equations the solution is attainable. One can notice that there are two possible solutions (because of the square power). These different solutions are supersonic and subsonic solution.

The distance friction,  $\frac{4fL}{D}$ , is selected as the choice for the independent variable. Thus, the equations need to be obtained as a function of  $\frac{4fL}{D}$ . The density is eliminated from equation (11.128) when combined with equation (11.133) to become

$$\frac{dP}{P} = -\frac{dU}{U} \quad (11.135)$$

After substituting the velocity (11.135) into equation (11.123), one can obtain

$$-\frac{dP}{P} - \frac{4f dx}{D_H} \left(\frac{k P M^2}{2}\right) = k P M^2 \frac{dP}{P} \quad (11.136)$$

Equation (11.136) can be rearranged into

$$\frac{dP}{P} = \frac{d\rho}{\rho} = -\frac{dU}{U} = -\frac{1}{2} \frac{dM^2}{M^2} = -\frac{k M^2}{2(1-k M^2)} 4f \frac{dx}{D} \quad (11.137)$$

Similarly or by other paths, the stagnation pressure can be expressed as a function of  $\frac{4fL}{D}$

$$\frac{dP_0}{P_0} = \frac{k M^2 \left(1 - \frac{k+1}{2} M^2\right)}{2(k M^2 - 1) \left(1 + \frac{k-1}{2} M^2\right)} 4f \frac{dx}{D} \quad (11.138)$$

<sup>13</sup>Assuming the upstream variables are known.

$$\frac{dT_0}{T_0} = \frac{k(1-k)M^2}{2(1-kM^2)\left(1 + \frac{k-1}{2}M^2\right)} 4f \frac{dx}{D} \quad (11.139)$$

The variables in equation (11.137) can be separated to obtain integrable form as follows

$$\int_0^L \frac{4f dx}{D} = \int_{M^2}^{1/k} \frac{1-kM^2}{kM^2} dM^2 \quad (11.140)$$

It can be noticed that at the entrance ( $x = 0$ ) for which  $M = M_{x=0}$  (the initial velocity in the tube isn't zero). The term  $\frac{4fL}{D}$  is positive for any  $x$ , thus, the term on the other side has to be positive as well. To obtain this restriction  $1 = kM^2$ . Thus, the value  $M = \frac{1}{\sqrt{k}}$  is the limiting case from a mathematical point of view. When Mach number larger than  $M > \frac{1}{\sqrt{k}}$  it makes the right hand side of the integrate negative. The physical meaning of this value is similar to  $M = 1$  choked flow which was discussed in a variable area flow in section (11.4).

Further it can be noticed from equation (11.139) that when  $M \rightarrow \frac{1}{\sqrt{k}}$  the value of right hand side approaches infinity ( $\infty$ ). Since the stagnation temperature ( $T_0$ ) has a finite value which means that  $dT_0 \rightarrow \infty$ . Heat transfer has a limited value therefore the model of the flow must be changed. A more appropriate model is an adiabatic flow model yet this model can serve as a bounding boundary (or limit).

Integration of equation (11.140) requires information about the relationship between the length,  $x$ , and friction factor  $f$ . The friction is a function of the Reynolds number along the tube. Knowing the Reynolds number variations is important. The Reynolds number is defined as

$$Re = \frac{DU\rho}{\mu} \quad (11.141)$$

The quantity  $U\rho$  is constant along the tube (mass conservation) under constant area. Thus, only viscosity is varied along the tube. However under the assumption of ideal gas, viscosity is only a function of the temperature. The temperature in isothermal process (the definition) is constant and thus the viscosity is constant. In real gas, the pressure effects are very minimal as described in "Basic of fluid mechanics" by this author. Thus, the friction factor can be integrated to yield

Friction Mach Isothermal Flow

$$\left. \frac{4fL}{D} \right|_{max} = \frac{1-kM^2}{kM^2} + \ln(kM^2) \quad (11.142)$$

The definition for perfect gas yields  $M^2 = U^2/kRT$  and noticing that  $T = \text{constant}$  is used to describe the relation of the properties at  $M = 1/\sqrt{k}$ . By denoting the superscript symbol \* for the choking condition, one can obtain that

$$\frac{M^2}{U^2} = \frac{1/k}{U^{*2}} \quad (11.143)$$

Rearranging equation (11.143) is transformed into

$$\frac{U}{U^*} = \sqrt{k}M \quad (11.144)$$

Utilizing the continuity equation provides

$$\rho U = \rho^* U^*; \implies \frac{\rho}{\rho^*} = \frac{1}{\sqrt{k}M} \quad (11.145)$$

Reusing the perfect-gas relationship

$$\boxed{\text{Pressure Ratio}} \quad \frac{P}{P^*} = \frac{\rho}{\rho^*} = \frac{1}{\sqrt{k}M} \quad (11.146)$$

Utilizing the relation for stagnated isotropic pressure one can obtain

$$\frac{P_0}{P^*} = \frac{P}{P^*} \left[ \frac{1 + \frac{k-1}{2}M^2}{1 + \frac{k-1}{2k}} \right]^{\frac{k}{k-1}} \quad (11.147)$$

Substituting for  $\frac{P}{P^*}$  equation (11.146) and rearranging yields

$$\boxed{\text{Stagnation Pressure Ratio}} \quad \frac{P_0}{P^*} = \frac{1}{\sqrt{k}} \left( \frac{2k}{3k-1} \right)^{\frac{k}{k-1}} \left( 1 + \frac{k-1}{2}M^2 \right)^{\frac{k}{k-1}} \frac{1}{M} \quad (11.148)$$

And the stagnation temperature at the critical point can be expressed as

$$\boxed{\text{Stagnation Pressure Ratio}} \quad \frac{T_0}{T^*} = \frac{T}{T^*} \frac{1 + \frac{k-1}{2}M^2}{1 + \frac{k-1}{2k}} = \frac{2k}{3k-1} \left( 1 + \frac{k-1}{2}M^2 \right) \quad (11.149)$$

These equations (11.144)-(11.149) are presented on in Figure (11.18).

### 11.6.3 The Entrance Limitation of Supersonic Branch

This setion deals with situations where the conditions at the tube exit have not arrived at the critical condition. It is very useful to obtain the relationships between the entrance and the exit conditions for this case. Denote 1 and 2 as the conditions at the inlet and exit respectably. From equation (11.137)

$$\frac{4fL}{D} = \frac{4fL}{D} \Big|_{max_1} - \frac{4fL}{D} \Big|_{max_2} = \frac{1-kM_1^2}{kM_1^2} - \frac{1-kM_2^2}{kM_2^2} + \ln \left( \frac{M_1}{M_2} \right)^2 \quad (11.150)$$



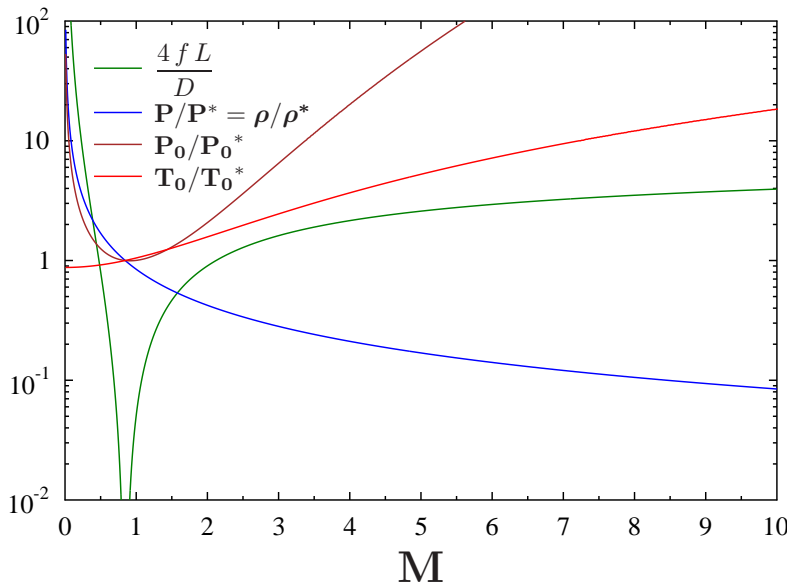

Fig. -11.18. Description of the pressure, temperature relationships as a function of the Mach number for isothermal flow.

For the case that  $M_1 \gg M_2$  and  $M_1 \rightarrow 1$  equation (11.150) is reduced into the following approximation

$$\frac{4fL}{D} = 2 \ln(M_1) - 1 - \overbrace{\frac{1 - k M_2^2}{k M_2^2}}^{\sim 0} \tag{11.151}$$

Solving for  $M_1$  results in

$$M_1 \sim e^{\frac{1}{2} \left( \frac{4fL}{D} + 1 \right)} \tag{11.152}$$

This relationship shows the maximum limit that Mach number can approach when the heat transfer is extraordinarily fast. In reality, even small  $\frac{4fL}{D} > 2$  results in a Mach number which is larger than 4.5. This velocity requires a large entrance length to achieve good heat transfer. With this conflicting mechanism obviously the flow is closer to the Fanno flow model. Yet this model provides the directions of the heat transfer effects on the flow.

Example 11.14:

Calculate the exit Mach number for pipe with  $\frac{4fL}{D} = 3$  under the assumption of the

isothermal flow and supersonic flow. Estimate the heat transfer needed to achieve this flow.

### 11.6.4 Supersonic Branch

Apparently, this analysis/model is over simplified for the supersonic branch and does not produce reasonable results since it neglects to take into account the heat transfer effects. A dimensionless analysis<sup>14</sup> demonstrates that all the common materials that the author is familiar with creates a large error in the fundamental assumption of the model and the model breaks. Nevertheless, this model can provide a better understanding to the trends and deviations from Fanno flow model.

In the supersonic flow, the hydraulic entry length is very large as will be shown below. However, the feeding diverging nozzle somewhat reduces the required entry length (as opposed to converging feeding). The thermal entry length is in the order of the hydrodynamic entry length (look at the Prandtl number<sup>15</sup>, (0.7-1.0), value for the common gases.). Most of the heat transfer is hampered in the sublayer thus the core assumption of isothermal flow (not enough heat transfer so the temperature isn't constant) breaks down<sup>16</sup>.

The flow speed at the entrance is very large, over hundred of meters per second. For example, a gas flows in a tube with  $\frac{4fL}{D} = 10$  the required entry Mach number is over 200. Almost all the perfect gas model substances dealt with in this book, the speed of sound is a function of temperature. For this illustration, for most gas cases the speed of sound is about  $300[m/sec]$ . For example, even with low temperature like  $200K$  the speed of sound of air is  $283[m/sec]$ . So, even for relatively small tubes with  $\frac{4fD}{D} = 10$  the inlet speed is over  $56 [km/sec]$ . This requires that the entrance length to be larger than the actual length of the tube for air. Remember from "Basics of Fluid Mechanics"<sup>17</sup>

$$L_{entrance} = 0.06 \frac{UD}{\nu} \quad (11.153)$$

The typical values of the kinetic viscosity,  $\nu$ , are  $0.0000185 \text{ kg/m-sec}$  at  $300K$  and  $0.0000130034 \text{ kg/m-sec}$  at  $200K$ . Combine this information with our case of  $\frac{4fL}{D} = 10$

$$\frac{L_{entrance}}{D} = 250746268.7$$

On the other hand a typical value of friction coefficient  $f = 0.005$  results in

$$\frac{L_{max}}{D} = \frac{10}{4 \times 0.005} = 500$$

<sup>14</sup>This dimensional analysis is a bit tricky, and is based on estimates. Currently and ashamedly the author is looking for a more simplified explanation. The current explanation is correct but based on hands waving and definitely does not satisfy the author.

<sup>15</sup> is relating thermal boundary layer to the momentum boundary layer.

<sup>16</sup>See Kays and Crawford "Convective Heat Transfer" (equation 12-12).

<sup>17</sup>Basics of Fluid Mechanics, Bar-Meir, Genick, Potta Project, 2013

The fact that the actual tube length is only less than 1% of the entry length means that the assumption is that the isothermal flow also breaks (as in a large response time). If Mach number is changing from 10 to 1 the kinetic energy change is about  $\frac{T_0}{T_0^*} = 18.37$  which means that the maximum amount of energy is insufficient.

Now with limitation, this topic will be covered in the next version because it provide some insight and boundary to the Fanno Flow model.

### 11.6.5 Figures and Tables

Table -11.4. The Isothermal Flow basic parameters

M	$\frac{4fL}{D}$	$\frac{P}{P^*}$	$\frac{P_0}{P_0^*}$	$\frac{\rho}{\rho^*}$	$\frac{T_0}{T_0^*}$
0.03000	785.97	28.1718	17.6651	28.1718	0.87516
0.04000	439.33	21.1289	13.2553	21.1289	0.87528
0.05000	279.06	16.9031	10.6109	16.9031	0.87544
0.06000	192.12	14.0859	8.8493	14.0859	0.87563
0.07000	139.79	12.0736	7.5920	12.0736	0.87586
0.08000	105.89	10.5644	6.6500	10.5644	0.87612
0.09000	82.7040	9.3906	5.9181	9.3906	0.87642
0.10000	66.1599	8.4515	5.3334	8.4515	0.87675
0.20000	13.9747	4.2258	2.7230	4.2258	0.88200
0.25000	7.9925	3.3806	2.2126	3.3806	0.88594
0.30000	4.8650	2.8172	1.8791	2.8172	0.89075
0.35000	3.0677	2.4147	1.6470	2.4147	0.89644
0.40000	1.9682	2.1129	1.4784	2.1129	0.90300
0.45000	1.2668	1.8781	1.3524	1.8781	0.91044
0.50000	0.80732	1.6903	1.2565	1.6903	0.91875
0.55000	0.50207	1.5366	1.1827	1.5366	0.92794
0.60000	0.29895	1.4086	1.1259	1.4086	0.93800
0.65000	0.16552	1.3002	1.0823	1.3002	0.94894
0.70000	0.08085	1.2074	1.0495	1.2074	0.96075

Table -11.4. The Isothermal Flow basic parameters (continue)

M	$\frac{4fL}{D}$	$\frac{P}{P^*}$	$\frac{P_0}{P_0^*}$	$\frac{\rho}{\rho^*}$	$\frac{T_0}{T_0^*}$
0.75000	0.03095	1.1269	1.0255	1.1269	0.97344
0.80000	0.00626	1.056	1.009	1.056	0.98700
0.81000	0.00371	1.043	1.007	1.043	0.98982
0.81879	0.00205	1.032	1.005	1.032	0.99232
0.82758	0.000896	1.021	1.003	1.021	0.99485
0.83637	0.000220	1.011	1.001	1.011	0.99741
0.84515	0.0	1.000	1.000	1.000	1.000

### 11.6.6 Isothermal Flow Examples

There can be several kinds of questions aside from the proof questions<sup>18</sup>. Generally, the “engineering” or practical questions can be divided into driving force (pressure difference), resistance (diameter, friction factor, friction coefficient, etc.), and mass flow rate questions. In this model no questions about shock (should) exist<sup>19</sup>.

The driving force questions deal with what should be the pressure difference to obtain a certain flow rate. Here is an example.

#### Example 11.15:

A tube of 0.25 [m] diameter and 5000 [m] in length is attached to a pump. What should be the pump pressure so that a flow rate of 2 [kg/sec] will be achieved? Assume that friction factor  $f = 0.005$  and the exit pressure is 1[bar]. The specific heat for the gas,  $k = 1.31$ , surroundings temperature 27°C,  $R = 290 \left[ \frac{J}{Kkg} \right]$ . Hint: calculate the maximum flow rate and then check if this request is reasonable.

#### SOLUTION

If the flow was incompressible then for known density,  $\rho$ , the velocity can be calculated by utilizing  $\Delta P = \frac{4fL}{D} \frac{U^2}{2g}$ . In incompressible flow, the density is a function of the entrance Mach number. The exit Mach number is not necessarily  $1/\sqrt{k}$  i.e. the flow is not choked. First, check whether flow is choked (or even possible).

<sup>18</sup>The proof questions are questions that ask for proof or for finding a mathematical identity (normally good for mathematicians and study of perturbation methods). These questions or examples will appear in the later versions.

<sup>19</sup>Those who are mathematically inclined can include these kinds of questions but there are no real world applications to isothermal model with shock.

Calculating the resistance,  $\frac{4fL}{D}$

$$\frac{4fL}{D} = \frac{4 \times 0.0055000}{0.25} = 400$$

Utilizing Table (11.4) or the Potto–GDC provides

M	$\frac{4fL}{D}$	$\frac{P}{P^*}$	$\frac{P_0}{P_0^*}$	$\frac{\rho}{\rho^*}$	$\frac{T_0}{T_0^*}$
0.04331	400.00	20.1743	12.5921	0.0	0.89446

The maximum flow rate (the limiting case) can be calculated by utilizing the above table. The velocity of the gas at the entrance  $U = cM = 0.04331 \times \sqrt{1.31 \times 290 \times 300} \cong 14.62 \left[ \frac{m}{sec} \right]$ . The density reads

$$\rho = \frac{P}{RT} = \frac{2,017,450}{290 \times 300} \cong 23.19 \left[ \frac{kg}{m^3} \right]$$

The maximum flow rate then reads

$$\dot{m} = \rho AU = 23.19 \times \frac{\pi \times (0.25)^2}{4} \times 14.62 \cong 16.9 \left[ \frac{kg}{sec} \right]$$

The maximum flow rate is larger than the requested mass rate hence the flow is not choked. It is note worthy to mention that since the isothermal model breaks around the choking point, the flow rate is really some what different. It is more appropriate to assume an isothermal model hence our model is appropriate.

For incompressible flow, the pressure loss is expressed as follows

$$P_1 - P_2 = \frac{4fL}{D} \frac{U^2}{2} \quad (11.XV.a)$$

Now note that for incompressible flow  $U_1 = U_2 = U$  and  $\frac{4fL}{D}$  represent the ratio of the traditional  $h_{12}$ . To obtain a similar expression for isothermal flow, a relationship between  $M_2$  and  $M_1$  and pressures has to be derived. From equation (11.XV.a) one can obtained that

$$M_2 = M_1 \frac{P_1}{P_2} \quad (11.XV.b)$$

To solve this problem the flow rate has to be calculated as

$$\dot{m} = \rho AU = 2.0 \left[ \frac{kg}{sec} \right]$$

$$\dot{m} = \frac{P_1}{RT} A \frac{kU}{k} = \frac{P_1}{\sqrt{kRT}} A \frac{kU}{\sqrt{kRT}} = \frac{P_1}{c} Ak M_1$$

Now combining with equation (11.XV.b) yields

$$\dot{m} = \frac{M_2 P_2 A k}{c}$$

$$M_2 = \frac{\dot{m} c}{P_2 A k} = \frac{2 \times 337.59}{100000 \times \frac{\pi \times (0.25)^2}{4} \times 1.31} = 0.103$$

From Table (11.4) or by utilizing the Potto–GDC one can obtain

M	$\frac{4fL}{D}$	$\frac{P}{P^*}$	$\frac{P_0}{P_0^*}$	$\frac{\rho}{\rho^*}$	$\frac{T_0}{T_0^*}$
0.10300	66.6779	8.4826	5.3249	0.0	0.89567

The entrance Mach number is obtained by

$$\left. \frac{4fL}{D} \right|_1 = 66.6779 + 400 \cong 466.68$$

Hence,

M	$\frac{4fL}{D}$	$\frac{P}{P^*}$	$\frac{P_0}{P_0^*}$	$\frac{\rho}{\rho^*}$	$\frac{T_0}{T_0^*}$
0.04014	466.68	21.7678	13.5844	0.0	0.89442

The pressure should be

$$P = 21.76780 \times 8.4826 = 2.566[\text{bar}]$$

Note that tables in this example are for  $k = 1.31$

---

End Solution

---

#### Example 11.16:

A flow of gas was considered for a distance of 0.5 [km] (500 [m]). A flow rate of 0.2 [kg/sec] is required. Due to safety concerns, the maximum pressure allowed for the gas is only 10[bar]. Assume that the flow is isothermal and  $k=1.4$ , calculate the required diameter of tube. The friction coefficient for the tube can be assumed as 0.02 (A relative smooth tube of cast iron.). Note that tubes are provided in increments of 0.5 [in]<sup>20</sup>. You can assume that the soundings temperature to be 27°C.

#### SOLUTION

At first, the minimum diameter will be obtained when the flow is choked. Thus, the

<sup>20</sup>It is unfortunate, but it seems that this standard will be around in USA for some time.

maximum  $M_1$  that can be obtained when the  $M_2$  is at its maximum and back pressure is at the atmospheric pressure.

$$M_1 = M_2 \frac{P_2}{P_1} = \overbrace{\frac{1}{\sqrt{k}}}^{M_{max}} \frac{1}{10} = 0.0845$$

Now, with the value of  $M_1$  either by utilizing Table (11.4) or using the provided program yields

M	$\frac{4fL}{D}$	$\frac{P}{P^*}$	$\frac{P_0}{P_0^*}$	$\frac{\rho}{\rho^*}$	$\frac{T_0}{T_0^*}$
0.08450	94.4310	10.0018	6.2991	0.0	0.87625

With  $\left. \frac{4fL}{D} \right|_{max} = 94.431$ , the value of minimum diameter.

$$D = \frac{4fL}{\left. \frac{4fL}{D} \right|_{max}} \simeq \frac{4 \times 0.02 \times 500}{94.43} \simeq 0.42359[m] = 16.68[in]$$

However, the pipes are provided only in 0.5 increments and the next size is 17[in] or 0.4318[m]. With this pipe size the calculations are to be repeated in reverse and produces: (Clearly the maximum mass is determined with)

$$\dot{m} = \rho A U = \rho A M c = \frac{P}{RT} A M \sqrt{k RT} = \frac{P A M \sqrt{k}}{\sqrt{RT}}$$

The usage of the above equation clearly applied to the whole pipe. The only point that must be emphasized is that all properties (like Mach number, pressure and etc) have to be taken at the same point. The new  $\left. \frac{4fL}{D} \right|_{max}$  is

$$\left. \frac{4fL}{D} \right|_{max} = \frac{4 \times 0.02 \times 500}{0.4318} \simeq 92.64$$

M	$\frac{4fL}{D}$	$\frac{P}{P^*}$	$\frac{P_0}{P_0^*}$	$\frac{\rho}{\rho^*}$	$\frac{T_0}{T_0^*}$
0.08527	92.6400	9.9110	6.2424	0.0	0.87627

To check whether the flow rate satisfies the requirement

$$\dot{m} = \frac{10^6 \times \frac{\pi \times 0.4318^2}{4} \times 0.0853 \times \sqrt{1.4}}{\sqrt{287 \times 300}} \approx 50.3[kg/sec]$$

Since  $50.3 \geq 0.2$  the mass flow rate requirement is satisfied.

It should be noted that  $P$  should be replaced by  $P_0$  in the calculations. The speed of sound at the entrance is

$$c = \sqrt{kRT} = \sqrt{1.4 \times 287 \times 300} \cong 347.2 \left[ \frac{m}{sec} \right]$$

and the density is

$$\rho = \frac{P}{RT} = \frac{1,000,000}{287 \times 300} = 11.61 \left[ \frac{kg}{m^3} \right]$$

The velocity at the entrance should be

$$U = M * c = 0.08528 \times 347.2 \cong 29.6 \left[ \frac{m}{sec} \right]$$

The diameter should be

$$D = \sqrt{\frac{4\dot{m}}{\pi U \rho}} = \sqrt{\frac{4 \times 0.2}{\pi \times 29.6 \times 11.61}} \cong 0.027$$

Nevertheless, for the sake of the exercise the other parameters will be calculated. This situation is reversed question. The flow rate is given with the diameter of the pipe. It should be noted that the flow isn't choked.

---

End Solution

---

#### Example 11.17:

A gas flows from a station (a) with pressure of 20[bar] through a pipe with 0.4[m] diameter and 4000 [m] length to a different station (b). The pressure at the exit (station (b)) is 2[bar]. The gas and the sounding temperature can be assumed to be 300 K. Assume that the flow is isothermal,  $k=1.4$ , and the average friction  $f=0.01$ . Calculate the Mach number at the entrance to pipe and the flow rate.

#### SOLUTION

First, the information whether the flow is choked needs to be found. Therefore, at first it will be assumed that the whole length is the maximum length.

$$\left. \frac{4fL}{D} \right|_{max} = \frac{4 \times 0.01 \times 4000}{0.4} = 400$$

with  $\left. \frac{4fL}{D} \right|_{max} = 400$  the following can be written

M	$\frac{4fL}{D}$	$\frac{T_0}{T_0^*T}$	$\frac{\rho}{\rho^*T}$	$\frac{P}{P^*T}$	$\frac{P_0}{P_0^*T}$
0.0419	400.72021	0.87531	20.19235	20.19235	12.66915



From the table  $M_1 \approx 0.0419$ , and  $\frac{P_0}{P_0^{*T}} \approx 12.67$

$$P_0^{*T} \cong \frac{28}{12.67} \cong 2.21[\text{bar}]$$

The pressure at point (b) by utilizing the isentropic relationship ( $M = 1$ ) pressure ratio is 0.52828.

$$P_2 = \frac{P_0^{*T}}{\left(\frac{P_2}{P_0^{*T}}\right)} = 2.21 \times 0.52828 = 1.17[\text{bar}]$$

As the pressure at point (b) is smaller than the actual pressure  $P^* < P_2$  than the actual pressure one must conclude that the flow is not choked. The solution is an iterative process.

1. guess reasonable value of  $M_1$  and calculate  $\frac{4fL}{D}$
2. Calculate the value of  $\frac{4fL}{D}\bigg|_2$  by subtracting  $\frac{4fL}{D}\bigg|_1 - \frac{4fL}{D}$
3. Obtain  $M_2$  from the Table ? or by using the Potto–GDC.
4. Calculate the pressure,  $P_2$  bear in mind that this isn't the real pressure but based on the assumption.
5. Compare the results of guessed pressure  $P_2$  with the actual pressure and choose new Mach number  $M_1$  accordingly.

The process has been done and is provided in Figure or in a table obtained from Potto–GDC.

$M_1$	$M_2$	$\frac{4fL}{D}\bigg _{\max}\bigg _1$	$\frac{4fL}{D}$	$\frac{P_2}{P_1}$
0.0419	0.59338	400.32131	400.00000	0.10000

The flow rate is

$$\dot{m} = \rho A M c = \frac{P\sqrt{k}}{\sqrt{RT}} \frac{\pi \times D^2}{4} M = \frac{2000000\sqrt{1.4}}{\sqrt{300 \times 287}} \pi \times 0.2^2 \times 0.0419 \cong 42.46[\text{kg/sec}]$$

---

End Solution

In this chapter, there are no examples on isothermal with supersonic flow.

Table -11.5. The flow parameters for unchoked flow

$M_1$	$M_2$	$\frac{4fL}{D} \Big _{\max} \Big _1$	$\frac{4fL}{D}$	$\frac{P_2}{P_1}$
0.7272	0.84095	0.05005	0.05000	0.10000
0.6934	0.83997	0.08978	0.08971	0.10000
0.6684	0.84018	0.12949	0.12942	0.10000
0.6483	0.83920	0.16922	0.16912	0.10000
0.5914	0.83889	0.32807	0.32795	0.10000
0.5807	0.83827	0.36780	0.36766	0.10000
0.5708	0.83740	0.40754	0.40737	0.10000

## 11.7 Fanno Flow

This adiabatic flow model with friction is named after Ginno Fanno a Jewish engineer. This model is the second pipe flow model described here. The main restriction for this model is that heat transfer is negligible and can be ignored<sup>21</sup>. This model is applicable to flow processes which are very fast compared to heat transfer mechanisms with small Eckert number. This model explains many industrial flow processes which includes emptying of pressured container through a relatively short tube, exhaust system of an internal combustion engine, compressed air systems, etc. As this model raised from the need to explain the steam flow in turbines.

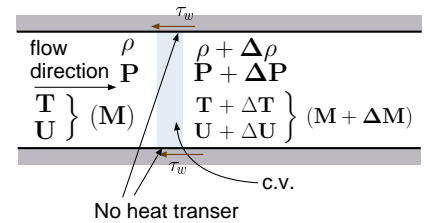

Fig. -11.19. Control volume of the gas flow in a constant cross section for Fanno Flow.

### 11.7.1 Introduction

Consider a gas flowing through a conduit with a friction (see Figure (11.19)). It is advantages to examine the simplest situation and yet without losing the core properties of the process. The mass (continuity equation) balance can be written as

$$\begin{aligned} \dot{m} &= \rho AU = \text{constant} \\ \Leftrightarrow \rho_1 U_1 &= \rho_2 U_2 \end{aligned} \quad (11.154)$$

<sup>21</sup>Even the friction does not convert into heat

The energy conservation (under the assumption that this model is adiabatic flow and the friction is not transformed into thermal energy) reads

$$\begin{aligned} \frac{T_{01}}{T_{02}} &= 1 \\ \hookrightarrow T_1 + \frac{U_1^2}{2c_p} &= T_2 + \frac{U_2^2}{2c_p} \end{aligned} \quad (11.155)$$

Or in a derivative from

$$C_p dT + d\left(\frac{U^2}{2}\right) = 0 \quad (11.156)$$

Again for simplicity, the perfect gas model is assumed<sup>22</sup>.

$$\begin{aligned} P &= \rho R T \\ \hookrightarrow \frac{P_1}{\rho_1 T_1} &= \frac{P_2}{\rho_2 T_2} \end{aligned} \quad (11.157)$$

It is assumed that the flow can be approximated as one-dimensional. The force acting on the gas is the friction at the wall and the momentum conservation reads

$$-A dP - \tau_w dA_w = \dot{m} dU \quad (11.158)$$

It is convenient to define a hydraulic diameter as

$$D_H = \frac{4 \times \text{Cross Section Area}}{\text{wetted perimeter}} \quad (11.159)$$

Or in other words

$$A = \frac{\pi D_H^2}{4} \quad (11.160)$$

It is convenient to substitute  $D$  for  $D_H$  and yet it still will be referred to the same name as the hydraulic diameter. The infinitesimal area that shear stress is acting on is

$$dA_w = \pi D dx \quad (11.161)$$

Introducing the Fanning friction factor as a dimensionless friction factor which is some times referred to as the friction coefficient and reads as the following:

$$f = \frac{\tau_w}{\frac{1}{2} \rho U^2} \quad (11.162)$$

By utilizing equation (11.154) and substituting equation (11.162) into momentum equation (11.158) yields

$$-\frac{\overbrace{\pi D^2}^A}{4} dP - \pi D dx \overbrace{f \left(\frac{1}{2} \rho U^2\right)}^{\tau_w} = A \overbrace{\rho U}^{\dot{m}/A} dU \quad (11.163)$$

<sup>22</sup>The equation of state is written again here so that all the relevant equations can be found.

Dividing equation (11.163) by the cross section area,  $\mathbf{A}$  and rearranging yields

$$-dP + \frac{4f dx}{D} \left( \frac{1}{2} \rho U^2 \right) = \rho U dU \quad (11.164)$$

The second law is the last equation to be utilized to determine the flow direction.

$$s_2 \geq s_1 \quad (11.165)$$

### 11.7.2 Non-Dimensionalization of the Equations

Before solving the above equation a dimensionless process is applied. By utilizing the definition of the sound speed to produce the following identities for perfect gas

$$M^2 = \left( \frac{U}{c} \right)^2 = \frac{U^2}{k \underbrace{RT}_{\frac{P}{\rho}}} \quad (11.166)$$

Utilizing the definition of the perfect gas results in

$$M^2 = \frac{\rho U^2}{k P} \quad (11.167)$$

Using the identity in equation (11.166) and substituting it into equation (11.163) and after some rearrangement yields

$$-dP + \frac{4f dx}{D_H} \left( \frac{1}{2} k P M^2 \right) = \frac{\rho U^2}{U} dU = \overbrace{k P M^2}^{\rho U^2} \frac{dU}{U} \quad (11.168)$$

By further rearranging equation (11.168) results in

$$-\frac{dP}{P} - \frac{4f dx}{D} \left( \frac{k M^2}{2} \right) = k M^2 \frac{dU}{U} \quad (11.169)$$

It is convenient to relate expressions of  $dP/P$  and  $dU/U$  in terms of the Mach number and substituting it into equation (11.169). Derivative of mass conservation (11.154) results in

$$\frac{d\rho}{\rho} + \overbrace{\frac{1}{2} \frac{dU^2}{U^2}}^{\frac{dU}{U}} = 0 \quad (11.170)$$

The derivation of the equation of state (11.157) and dividing the results by equation of state (11.157) results

$$\frac{dP}{P} = \frac{d\rho}{\rho} + \frac{dT}{dT} \quad (11.171)$$

Differentiating of equation (11.166) and dividing by equation (11.166) yields

$$\frac{d(M^2)}{M^2} = \frac{d(U^2)}{U^2} - \frac{dT}{T} \quad (11.172)$$

Dividing the energy equation (11.156) by  $C_p$  and by utilizing the definition Mach number yields

$$\begin{aligned} \frac{dT}{T} + \underbrace{\left( \frac{1}{kR} \right)}_{C_p} \frac{1}{T} \frac{U^2}{U^2} d\left(\frac{U^2}{2}\right) &= \\ \Leftrightarrow \frac{dT}{T} + \frac{(k-1)U^2}{kRT} d\left(\frac{U^2}{2}\right) &= \\ \Leftrightarrow \frac{dT}{T} + \frac{k-1}{2} M^2 \frac{dU^2}{U^2} &= 0 \end{aligned} \quad (11.173)$$

Equations (11.169), (11.170), (11.171), (11.172), and (11.173) need to be solved. These equations are separable so one variable is a function of only single variable (the chosen as the independent variable). Explicit explanation is provided for only two variables, the rest variables can be done in a similar fashion. The dimensionless friction,  $\frac{4fL}{D}$ , is chosen as the independent variable since the change in the dimensionless resistance,  $\frac{4fL}{D}$ , causes the change in the other variables.

Combining equations (11.171) and (11.173) when eliminating  $dT/T$  results

$$\frac{dP}{P} = \frac{d\rho}{\rho} - \frac{(k-1)M^2}{2} \frac{dU^2}{U^2} \quad (11.174)$$

The term  $d\rho/\rho$  can be eliminated by utilizing equation (11.170) and substituting it into equation (11.174) and rearrangement yields

$$\frac{dP}{P} = -\frac{1+(k-1)M^2}{2} \frac{dU^2}{U^2} \quad (11.175)$$

The term  $dU^2/U^2$  can be eliminated by using (11.175)

$$\frac{dP}{P} = -\frac{kM^2(1+(k-1)M^2)}{2(1-M^2)} \frac{4f dx}{D} \quad (11.176)$$

The second equation for Mach number,  $M$  variable is obtained by combining equation (11.172) and (11.173) by eliminating  $dT/T$ . Then  $d\rho/\rho$  and  $U$  are eliminated by utilizing equation (11.170) and equation (11.174). The only variable that is left is  $P$  (or  $dP/P$ ) which can be eliminated by utilizing equation (11.176) and results in

$$\frac{4f dx}{D} = \frac{(1-M^2) dM^2}{kM^4(1+\frac{k-1}{2}M^2)} \quad (11.177)$$

Rearranging equation (11.177) results in

$$\frac{dM^2}{M^2} = \frac{k M^2 \left(1 + \frac{k-1}{2} M^2\right)}{1 - M^2} \frac{4 f dx}{D} \quad (11.178)$$

After similar mathematical manipulation one can get the relationship for the velocity to read

$$\frac{dU}{U} = \frac{k M^2}{2(1 - M^2)} \frac{4 f dx}{D} \quad (11.179)$$

and the relationship for the temperature is

$$\frac{dT}{T} = \frac{1}{2} \frac{dc}{c} = -\frac{k(k-1) M^4}{2(1 - M^2)} \frac{4 f dx}{D} \quad (11.180)$$

density is obtained by utilizing equations (11.179) and (11.170) to obtain

$$\frac{d\rho}{\rho} = -\frac{k M^2}{2(1 - M^2)} \frac{4 f dx}{D} \quad (11.181)$$

The stagnation pressure is similarly obtained as

$$\frac{dP_0}{P_0} = -\frac{k M^2}{2} \frac{4 f dx}{D} \quad (11.182)$$

The second law reads

$$ds = C_p \ln \left( \frac{dT}{T} \right) - R \ln \left( \frac{dP}{P} \right) \quad (11.183)$$

The stagnation temperature expresses as  $T_0 = T(1 + (1 - k)/2M^2)$ . Taking derivative of this expression when  $M$  remains constant yields  $dT_0 = dT(1 + (1 - k)/2M^2)$  and thus when these equations are divided they yield

$$dT/T = dT_0/T_0 \quad (11.184)$$

In similar fashion the relationship between the stagnation pressure and the pressure can be substituted into the entropy equation and result in

$$ds = C_p \ln \left( \frac{dT_0}{T_0} \right) - R \ln \left( \frac{dP_0}{P_0} \right) \quad (11.185)$$

The first law requires that the stagnation temperature remains constant, ( $dT_0 = 0$ ). Therefore the entropy change is

$$\frac{ds}{C_p} = -\frac{(k-1)}{k} \frac{dP_0}{P_0} \quad (11.186)$$

Using the equation for stagnation pressure the entropy equation yields

$$\frac{ds}{C_p} = \frac{(k-1) M^2}{2} \frac{4 f dx}{D} \quad (11.187)$$

### 11.7.3 The Mechanics and Why the Flow is Choked?

The trends of the properties can be examined by looking in equations (11.176) through (11.186). For example, from equation (11.176) it can be observed that the critical point is when  $M = 1$ . When  $M < 1$  the pressure decreases downstream as can be seen from equation (11.176) because  $f dx$  and  $M$  are positive. For the same reasons, in the supersonic branch,  $M > 1$ , the pressure increases downstream. This pressure increase is what makes compressible flow so different from "conventional" flow. Thus the discussion will be divided into two cases: One, flow above speed of sound. Two, flow with speed below the speed of sound.

#### 11.7.3.1 Why the flow is choked?

Here, the explanation is based on the equations developed earlier and there is no known explanation that is based on the physics. First, it has to be recognized that the critical point is when  $M = 1$ . It will be shown that a change in location relative to this point change the trend and it is singular point by itself. For example,  $dP(@M = 1) = \infty$  and mathematically it is a singular point (see equation (11.176)). Observing from equation (11.176) that increase or decrease from subsonic just below one  $M = (1 - \epsilon)$  to above just above one  $M = (1 + \epsilon)$  requires a change in a sign pressure direction. However, the pressure has to be a monotonic function which means that flow cannot cross over the point of  $M = 1$ . This constrain means that because the flow cannot "crossover"  $M = 1$  the gas has to reach to this speed,  $M = 1$  at the last point. This situation is called choked flow.

#### 11.7.3.2 The Trends

The trends or whether the variables are increasing or decreasing can be observed from looking at the equation developed. For example, the pressure can be examined by looking at equation (11.178). It demonstrates that the Mach number increases downstream when the flow is subsonic. On the other hand, when the flow is supersonic, the pressure decreases.

The summary of the properties changes on the sides of the branch

	<u>Subsonic</u>	<u>Supersonic</u>
Pressure, $P$	decrease	increase
Mach number, $M$	increase	decrease
Velocity, $U$	increase	decrease
Temperature, $T$	decrease	increase
Density, $\rho$	decrease	increase

### 11.7.4 The Working Equations

Integration of equation (11.177) yields

Fanno FLD-M

$$\frac{4}{D} \int_L^{L_{max}} f dx = \frac{1}{k} \frac{1 - M^2}{M^2} + \frac{k+1}{2k} \ln \frac{\frac{k+1}{2} M^2}{1 + \frac{k-1}{2} M^2} \quad (11.188)$$

A representative friction factor is defined as

$$\bar{f} = \frac{1}{L_{max}} \int_0^{L_{max}} f dx \quad (11.189)$$

In the isothermal flow model it was shown that friction factor is constant through the process if the fluid is ideal gas. Here, the Reynolds number defined in equation (11.141) is not constant because the temperature is not constant. The viscosity even for ideal gas is complex function of the temperature (further reading in “Basic of Fluid Mechanics” chapter one, Potto Project). However, the temperature variation is very limited. Simple improvement can be done by assuming constant constant viscosity (constant friction factor) and find the temperature on the two sides of the tube to improve the friction factor for the next iteration. The maximum error can be estimated by looking at the maximum change of the temperature. The temperature can be reduced by less than 20% for most range of the specific heats ratio. The viscosity change for this change is for many gases about 10%. For these gases the maximum increase of average Reynolds number is only 5%. What this change in Reynolds number does to friction factor? That depend in the range of Reynolds number. For Reynolds number larger than 10,000 the change in friction factor can be considered negligible. For the other extreme, laminar flow it can estimated that change of 5% in Reynolds number change about the same amount in friction factor. With the exception of the jump from a laminar flow to a turbulent flow, the change is noticeable but very small. In the light of the about discussion the friction factor is assumed to constant. By utilizing the mean average theorem equation (11.188) yields

Resistance Mach Relationship

$$\frac{4 \bar{f} L_{max}}{D} = \frac{1}{k} \left( \frac{1 - M^2}{M^2} \right) + \frac{k+1}{2k} \ln \left( \frac{\frac{k+1}{2} M^2}{1 + \frac{k-1}{2} M^2} \right) \quad (11.190)$$

Equations (11.176), (11.179), (11.180), (11.181), (11.181), and (11.182) can be solved. For example, the pressure as written in equation (11.175) is represented by  $\frac{4fL}{D}$ , and Mach number. Now equation (11.176) can eliminate term  $\frac{4fL}{D}$  and describe the



pressure on the Mach number. Dividing equation (11.176) in equation (11.178) yields

$$\frac{\frac{dP}{P}}{\frac{dM^2}{M^2}} = -\frac{1 + (k - 1)M^2}{2M^2 \left(1 + \frac{k-1}{2}M^2\right)} dM^2 \quad (11.191)$$

The symbol “\*” denotes the state when the flow is choked and Mach number is equal to 1. Thus,  $M = 1$  when  $P = P^*$  equation (11.191) can be integrated to yield:

**Mach-Pressure Ratio**

$$\frac{P}{P^*} = \frac{1}{M} \sqrt{\frac{\frac{k+1}{2}}{1 + \frac{k-1}{2}M^2}} \quad (11.192)$$

In the same fashion the variables ratios can be obtained

**Temperature Ratio**

$$\frac{T}{T^*} = \frac{c^2}{c^{*2}} = \frac{\frac{k+1}{2}}{1 + \frac{k-1}{2}M^2} \quad (11.193)$$

The density ratio is

**Density Ratio**

$$\frac{\rho}{\rho^*} = \frac{1}{M} \sqrt{\frac{1 + \frac{k-1}{2}M^2}{\frac{k+1}{2}}} \quad (11.194)$$

The velocity ratio is

**Velocity Ratio**

$$\frac{U}{U^*} = \left(\frac{\rho}{\rho^*}\right)^{-1} = M \sqrt{\frac{\frac{k+1}{2}}{1 + \frac{k-1}{2}M^2}} \quad (11.195)$$

The stagnation pressure decreases and can be expressed by

$$\frac{P_0}{P_0^*} = \frac{\overbrace{\left(\frac{P_0}{P}\right)^{\frac{k}{k-1}} P}^{\left(1 + \frac{1-k}{2}M^2\right)^{\frac{k}{k-1}}}}{\underbrace{\left(\frac{P_0^*}{P^*}\right)^{\frac{k}{k-1}} P^*}_{\left(\frac{2}{k+1}\right)^{\frac{k}{k-1}}}} \quad (11.196)$$

Using the pressure ratio in equation (11.192) and substituting it into equation (11.196) yields

$$\frac{P_0}{P_0^*} = \left( \frac{1 + \frac{k-1}{2} M^2}{\frac{k+1}{2}} \right)^{\frac{k}{k-1}} \frac{1}{M} \sqrt{\frac{1 + \frac{k-1}{2} M^2}{\frac{k+1}{2}}} \quad (11.197)$$

And further rearranging equation (11.197) provides

Stagnation Pressure Ratio

$$\frac{P_0}{P_0^*} = \frac{1}{M} \left( \frac{1 + \frac{k-1}{2} M^2}{\frac{k+1}{2}} \right)^{\frac{k+1}{2(k-1)}} \quad (11.198)$$

The integration of equation (11.186) yields

$$\frac{s - s^*}{C_p} = \ln M^2 \sqrt{\left( \frac{k+1}{2 M^2 \left( 1 + \frac{k-1}{2} M^2 \right)} \right)^{\frac{k+1}{k}}} \quad (11.199)$$

The results of these equations are plotted in Figure 11.20

The Fanno flow is in many cases shockless and therefore a relationship between two points should be derived. In most times, the “star” values are imaginary values that represent the value at choking. The real ratio can be obtained by two star ratios as an example

$$\frac{T_2}{T_1} = \frac{\left. \frac{T}{T^*} \right|_{M_2}}{\left. \frac{T}{T^*} \right|_{M_1}} \quad (11.200)$$

A special interest is the equation for the dimensionless friction as following

$$\int_{L_1}^{L_2} \frac{4 f L}{D} dx = \int_{L_1}^{L_{max}} \frac{4 f L}{D} dx - \int_{L_2}^{L_{max}} \frac{4 f L}{D} dx \quad (11.201)$$

Hence,

fL Working Equation

$$\left( \frac{4 f L_{max}}{D} \right)_2 = \left( \frac{4 f L_{max}}{D} \right)_1 - \frac{4 f L}{D} \quad (11.202)$$

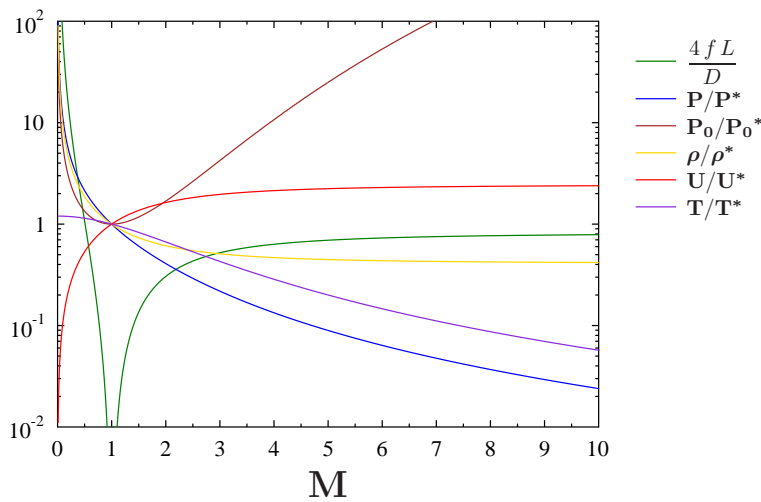

Fig. -11.20. Various parameters in Fanno flow shown as a function of Mach number.

### 11.7.5 Examples of Fanno Flow

#### Example 11.18:

Air flows from a reservoir and enters a uniform pipe with a diameter of  $0.05$  [m] and length of  $10$  [m].

The air exits to the atmosphere.

The following conditions prevail at the exit:  $P_2 = 1$  [bar] temperature  $T_2 = 27^\circ\text{C}$   $M_2 = 0.9$ <sup>23</sup>. Assume that the average friction factor to be  $f = 0.004$  and that the flow from the reservoir up to the pipe inlet is essentially isentropic. Estimate the total temperature and total pressure in the reservoir under the Fanno flow model.

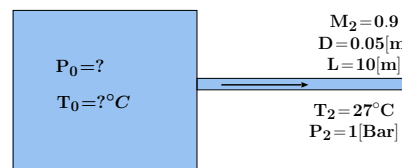

Fig. -11.21. Schematic of Example 11.18.

#### SOLUTION

For isentropic, the flow to the pipe inlet, the temperature and the total pressure at the pipe inlet are the same as those in the reservoir. Thus, finding the star pressure and temperature at the pipe inlet is the solution. With the Mach number and temperature known at the exit, the total temperature at the entrance can be obtained by knowing the  $\frac{4fL}{D}$ . For given Mach number ( $M = 0.9$ ) the following is obtained.

<sup>23</sup>This property is given only for academic purposes. There is no Mach meter.

M	$\frac{4fL}{D}$	$\frac{P}{P^*}$	$\frac{P_0}{P_0^*}$	$\frac{\rho}{\rho^*}$	$\frac{U}{U^*}$	$\frac{T}{T^*}$
0.90000	0.01451	1.1291	1.0089	1.0934	0.9146	1.0327

So, the total temperature at the exit is

$$T^*|_2 = \frac{T^*}{T}|_2 T_2 = \frac{300}{1.0327} = 290.5[K]$$

To "move" to the other side of the tube the  $\frac{4fL}{D}$  is added as

$$\frac{4fL}{D}|_1 = \frac{4fL}{D} + \frac{4fL}{D}|_2 = \frac{4 \times 0.004 \times 10}{0.05} + 0.01451 \simeq 3.21$$

The rest of the parameters can be obtained with the new  $\frac{4fL}{D}$  either from Table (11.6) by interpolations or by utilizing the attached program.

M	$\frac{4fL}{D}$	$\frac{P}{P^*}$	$\frac{P_0}{P_0^*}$	$\frac{\rho}{\rho^*}$	$\frac{U}{U^*}$	$\frac{T}{T^*}$
0.35886	3.2100	3.0140	1.7405	2.5764	0.38814	1.1699

Note that the subsonic branch is chosen. The stagnation ratios has to be added for  $M = 0.35886$

M	$\frac{T}{T_0}$	$\frac{\rho}{\rho_0}$	$\frac{A}{A^*}$	$\frac{P}{P_0}$	$\frac{A \times P}{A^* \times P_0}$	$\frac{F}{F^*}$
0.35886	0.97489	0.93840	1.7405	0.91484	1.5922	0.78305

The total pressure  $P_{01}$  can be found from the combination of the ratios as follows:

$$\begin{aligned}
 P_{01} &= P_2 \overbrace{\frac{P^*}{P}}|_2 \overbrace{\frac{P}{P^*}}|_1 \overbrace{\frac{P_0}{P}}|_1 \\
 &= 1 \times \frac{1}{1.12913} \times 3.014 \times \frac{1}{0.915} = 2.91[Bar]
 \end{aligned}$$

$$\begin{aligned}
 T_{01} &= T_2 \overbrace{\frac{T^*}{T}}|_2 \overbrace{\frac{T}{T^*}}|_1 \overbrace{\frac{T_0}{T}}|_1 \\
 &= 300 \times \frac{1}{1.0327} \times 1.17 \times \frac{1}{0.975} \simeq 348K = 75^\circ C
 \end{aligned}$$

End Solution

Another academic question/example:

**Example 11.19:**

A system is composed of a convergent-divergent nozzle followed by a tube with length of 2.5 [cm] in diameter and 1.0 [m] long. The system is supplied by a vessel. The vessel conditions are at 29.65 [Bar], 400 K. With these conditions a pipe inlet Mach number is 3.0. A normal shock wave occurs in the tube and the flow discharges to the atmosphere, determine:

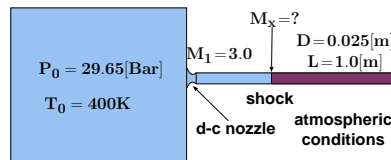

Fig. -11.22. The schematic of Example (11.19).

- the mass flow rate through the system;
- the temperature at the pipe exit; and
- determine the Mach number when a normal shock wave occurs [ $M_x$ ].

Take  $k = 1.4$ ,  $R = 287 [J/kgK]$  and  $f = 0.005$ .

**SOLUTION**

- Assuming that the pressure vessel is very much larger than the pipe, therefore the velocity in the vessel can be assumed to be small enough so it can be neglected. Thus, the stagnation conditions can be approximated for the condition in the tank. It is further assumed that the flow through the nozzle can be approximated as isentropic. Hence,  $T_{01} = 400K$  and  $P_{01} = 29.65[Bar]$ .

The mass flow rate through the system is constant and for simplicity point 1 is chosen in which,

$$\dot{m} = \rho A M c$$

The density and speed of sound are unknowns and need to be computed. With the isentropic relationship, the Mach number at point one (1) is known, then the following can be found either from Table 11.6, or the popular Potto-GDC as

M	$\frac{T}{T_0}$	$\frac{\rho}{\rho_0}$	$\frac{A}{A^*}$	$\frac{P}{P_0}$	$\frac{A \times P}{A^* \times P_0}$	$\frac{F}{F^*}$
3.0000	0.35714	0.07623	4.2346	0.02722	0.11528	0.65326

The temperature is

$$T_1 = \frac{T_1}{T_{01}} T_{01} = 0.357 \times 400 = 142.8K$$

Using the temperature, the speed of sound can be calculated as

$$c_1 = \sqrt{kRT} = \sqrt{1.4 \times 287 \times 142.8} \simeq 239.54[m/sec]$$

The pressure at point 1 can be calculated as

$$P_1 = \frac{P_1}{P_{01}} P_{01} = 0.027 \times 30 \simeq 0.81[Bar]$$

The density as a function of other properties at point 1 is

$$\rho_1 = \frac{P}{RT} \Big|_1 = \frac{8.1 \times 10^4}{287 \times 142.8} \simeq 1.97 \left[ \frac{kg}{m^3} \right]$$

The mass flow rate can be evaluated from equation (11.154)

$$\dot{m} = 1.97 \times \frac{\pi \times 0.025^2}{4} \times 3 \times 239.54 = 0.69 \left[ \frac{kg}{sec} \right]$$

- (b) First, check whether the flow is shockless by comparing the flow resistance and the maximum possible resistance. From the Table 11.6 or by using the famous Potto-GDC, is to obtain the following

M	$\frac{4fL}{D}$	$\frac{P}{P^*}$	$\frac{P_0}{P_0^*}$	$\frac{\rho}{\rho^*}$	$\frac{U}{U^*}$	$\frac{T}{T^*}$
3.0000	0.52216	0.21822	4.2346	0.50918	1.9640	0.42857

and the conditions of the tube are

$$\frac{4fL}{D} = \frac{4 \times 0.005 \times 1.0}{0.025} = 0.8$$

Since  $0.8 > 0.52216$  the flow is choked and with a shock wave.

The exit pressure determines the location of the shock, if a shock exists, by comparing "possible"  $P_{exit}$  to  $P_B$ . Two possibilities are needed to be checked; one, the shock at the entrance of the tube, and two, shock at the exit and comparing the pressure ratios. First, the possibility that the shock wave occurs immediately at the entrance for which the ratio for  $M_x$  are (shock wave Table 11.3)

$M_x$	$M_y$	$\frac{T_y}{T_x}$	$\frac{\rho_y}{\rho_x}$	$\frac{P_y}{P_x}$	$\frac{P_{0y}}{P_{0x}}$
3.0000	0.47519	2.6790	3.8571	10.3333	0.32834

After the shock wave the flow is subsonic with " $M_1$ " = 0.47519. (Fanno flow Table 11.6)

$M$	$\frac{4fL}{D}$	$\frac{P}{P^*}$	$\frac{P_0}{P_0^*}$	$\frac{\rho}{\rho^*}$	$\frac{U}{U^*}$	$\frac{T}{T^*}$
0.47519	1.2919	2.2549	1.3904	1.9640	0.50917	1.1481

The stagnation values for  $M = 0.47519$  are

$M$	$\frac{T}{T_0}$	$\frac{\rho}{\rho_0}$	$\frac{A}{A^*}$	$\frac{P}{P_0}$	$\frac{A \times P}{A^* \times P_0}$	$\frac{F}{F^*}$
0.47519	0.95679	0.89545	1.3904	0.85676	1.1912	0.65326

The ratio of exit pressure to the chamber total pressure is

$$\begin{aligned} \frac{P_2}{P_0} &= \overbrace{\left(\frac{P_2}{P^*}\right)}^1 \left(\frac{P^*}{P_1}\right) \left(\frac{P_1}{P_{0y}}\right) \left(\frac{P_{0y}}{P_{0x}}\right) \overbrace{\left(\frac{P_{0x}}{P_0}\right)}^1 \\ &= 1 \times \frac{1}{2.2549} \times 0.8568 \times 0.32834 \times 1 \\ &= 0.12476 \end{aligned}$$

The actual pressure ratio  $1/29.65 = 0.0338$  is smaller than the case in which shock occurs at the entrance. Thus, the shock is somewhere downstream. One possible way to find the exit temperature,  $T_2$  is by finding the location of the shock. To find the location of the shock ratio of the pressure ratio,  $\frac{P_2}{P_1}$  is needed. With the location of shock, "claiming" upstream from the exit through shock to the entrance. For example, calculate the parameters for shock location with known  $\frac{4fL}{D}$  in the "y" side. Then either by utilizing shock table or the program, to obtain the upstream Mach number.

The procedure for the calculations:

Calculate the entrance Mach number assuming the shock occurs at the exit:

- 1) a) set  $M_2' = 1$  assume the flow in the entire tube is supersonic:
- b) calculated  $M_1'$

Note this Mach number is the high Value.

Calculate the entrance Mach assuming shock at the entrance.

- a) set  $M_2 = 1$
- 2) b) add  $\frac{4fL}{D}$  and calculated  $M_1'$  for subsonic branch
- c) calculated  $M_x$  for  $M_1'$

Note this Mach number is the low Value.

According your root finding algorithm<sup>24</sup> calculate or guess the shock location and then compute as above the new  $M_1$ .

- a) set  $M_2 = 1$
- 3) b) for the new  $\frac{4fL}{D}$  and compute the new  $M_y'$  for the subsonic branch
- c) calculated  $M_x'$  for the  $M_y'$
- d) Add the leftover of  $\frac{4fL}{D}$  and calculated the  $M_1$
- 4) guess new location for the shock according to your finding root procedure and according to the result, repeat previous stage until the solution is obtained.

$M_1$	$M_2$	$\frac{4fL}{D} _{up}$	$\frac{4fL}{D} _{down}$	$M_x$	$M_y$
3.0000	1.0000	0.22019	0.57981	1.9899	0.57910

- (c) The way of the numerical procedure for solving this problem is by finding  $\frac{4fL}{D}|_{up}$  that will produce  $M_1 = 3$ . In the process  $M_x$  and  $M_y$  must be calculated (see the chapter on the program with its algorithms.).

---

End Solution

---

### Supersonic Branch

In Section (11.6) it was shown that the isothermal model cannot describe adequately the situation because the thermal entry length is relatively large compared to the pipe length and the heat transfer is not sufficient to maintain constant temperature. In the Fanno model there is no heat transfer, and, furthermore, because the very limited amount of heat transformed it is closer to an adiabatic flow. The only limitation of the model is its uniform velocity (assuming parabolic flow for laminar and different profile for turbulent flow.). The information from the wall to the tube center<sup>25</sup> is slower in reality. However, experiments from many starting with 1938 work by Frossel<sup>26</sup> has shown that the error is not significant. Nevertheless, the comparison with reality shows that heat transfer cause changes to the flow and they need/should to be expected. These changes include the choking point at lower Mach number.

<sup>24</sup>You can use any method you which, but be-careful second order methods like Newton-Rapson method can be unstable.

<sup>25</sup>The word information referred to is the shear stress transformed from the wall to the center of the tube.

<sup>26</sup>See on the web <http://naca.larc.nasa.gov/digidoc/report/tm/44/NACA-TM-844.PDF>



### 11.7.5.1 Maximum Length for the Supersonic Flow

It has to be noted and recognized that as opposed to subsonic branch the supersonic branch has a limited length. It also must be recognized that there is a maximum length for which only supersonic flow can exist<sup>27</sup>. These results were obtained from the mathematical derivations but were verified by numerous experiments<sup>28</sup>. The maximum length of the supersonic can be evaluated when  $M = \infty$  as follows:

$$\begin{aligned} \frac{4fL_{max}}{D} &= \frac{1 - M^2}{kM^2} + \frac{k + 1}{2k} \ln \frac{\frac{k+1}{2} M^2}{2 \left(1 + \frac{k-1}{2} M^2\right)} = \\ \frac{4fL}{D} (M \rightarrow \infty) &\sim \frac{-\infty}{k \times \infty} + \frac{k + 1}{2k} \ln \frac{(k + 1)\infty}{(k - 1)\infty} \\ &= \frac{-1}{k} + \frac{k + 1}{2k} \ln \frac{(k + 1)}{(k - 1)} \\ &= \frac{4fL}{D} (M \rightarrow \infty, k = 1.4) = 0.8215 \\ \frac{4fL_{max}}{D} &= \frac{4fL}{D} (M \rightarrow \infty, k = 1.4) = 0.8215 \end{aligned} \tag{11.203}$$

The maximum length of the supersonic flow is limited by the above number. From the above analysis, it can be observed that no matter how high the entrance Mach number will be the tube length is limited and depends only on specific heat ratio,  $k$ .

### 11.7.6 Working Conditions

It has to be recognized that there are two regimes that can occur in Fanno flow model one of subsonic flow and the other supersonic flow. Even the flow in the tube starts as a supersonic in parts of the tube can be transformed into the subsonic branch. A shock wave can occur and some portions of the tube will be in a subsonic flow pattern.

The discussion has to differentiate between two ways of feeding the tube: converging nozzle or a converging-diverging nozzle. Three parameters, the dimensionless friction,  $\frac{4fL}{D}$ , the entrance Mach number,  $M_1$ , and the pressure ratio,  $P_2/P_1$  are controlling the flow. Only a combination of these two parameters is truly independent. However, all the three parameters can be varied and some are discussed separately here.

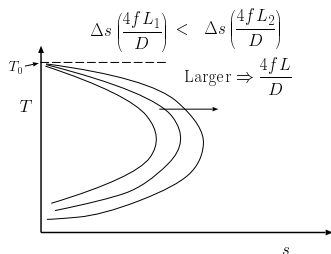

Fig. -11.23. The effects of increase of  $\frac{4fL}{D}$  on the Fanno line.

<sup>27</sup>Many in the industry have difficulties in understanding this concept. The author seeks for a nice explanation of this concept for non-fluid mechanics engineers. This solicitation is about how to explain this issue to non-engineers or engineer without a proper background.

<sup>28</sup>If you have experiments demonstrating this point, please provide to the undersign so they can be added to this book. Many of the pictures in the literature carry copyright statements and thus can be presented here.

**11.7.6.1 Variations of The Tube Length ( $\frac{4fL}{D}$ ) Effects**

In the analysis of this effect, it should be assumed that back pressure is constant and/or low as possible as needed to maintain a choked flow. First, the treatment of the two branches are separated.

**Fanno Flow Subsonic branch**

For converging nozzle feeding, increasing the tube length results in increasing the exit Mach number (normally denoted herein as  $M_2$ ). Once the Mach number reaches maximum ( $M = 1$ ), no further increase of the exit Mach number can be achieved with same pressure ratio mass flow rate. For increase in the pipe length results in mass flow rate decreases. It is worth noting that entrance Mach number is reduced (as some might explain it to reduce the flow rate). The entrance temperature increases as can be seen from Figure (11.24). The velocity therefore must decrease because the loss of the enthalpy (stagnation temperature) is “used.” The density decrease because  $\rho = \frac{P}{RT}$  and when pressure is remains almost constant the density decreases. Thus, the mass flow rate must decrease. These results are applicable to the converging nozzle.

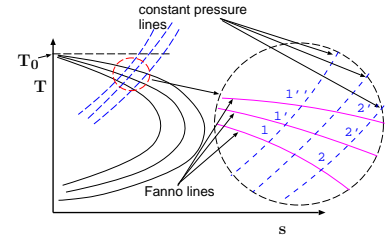

Fig. -11.24. The effects of the increase of  $\frac{4fL}{D}$  on the Fanno Line.

In the case of the converging–diverging feeding nozzle, increase of the dimensionless friction,  $\frac{4fL}{D}$ , results in a similar flow pattern as in the converging nozzle. Once the flow becomes choked a different flow pattern emerges.

**11.7.6.2 Fanno Flow Supersonic Branch**

There are several transitional points that change the pattern of the flow. Point a is the choking point (for the supersonic branch) in which the exit Mach number reaches to one. Point b is the maximum possible flow for supersonic flow and is not dependent on the nozzle. The next point, referred here as the critical point c, is the point in which no supersonic flow is possible in the tube i.e. the shock reaches to the nozzle. There is another point d, in which no supersonic flow is possible in the entire nozzle–tube system. Between these transitional points the effect parameters such as mass flow rate, entrance and exit Mach number are discussed.

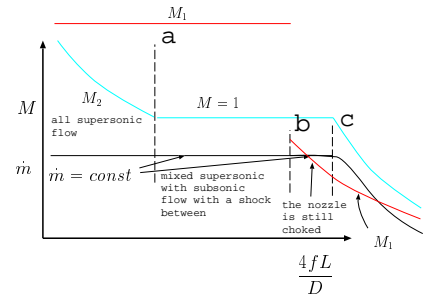

Fig. -11.25. The Mach numbers at entrance and exit of tube and mass flow rate for Fanno Flow as a function of the  $\frac{4fL}{D}$ .

At the starting point the flow is choked in the nozzle, to achieve supersonic flow. The following ranges that has to be discussed includes (see Figure (11.25)):

---

$$\begin{array}{rcll}
 0 & < & \frac{4fL}{D} & < & \left(\frac{4fL}{D}\right)_{choking} & & 0 \rightarrow \mathbf{a} \\
 \left(\frac{4fL}{D}\right)_{choking} & < & \frac{4fL}{D} & < & \left(\frac{4fL}{D}\right)_{shockless} & & \mathbf{a} \rightarrow \mathbf{b} \\
 \left(\frac{4fL}{D}\right)_{shockless} & < & \frac{4fL}{D} & < & \left(\frac{4fL}{D}\right)_{chokeless} & & \mathbf{b} \rightarrow \mathbf{c} \\
 \left(\frac{4fL}{D}\right)_{chokeless} & < & \frac{4fL}{D} & < & \infty & & \mathbf{c} \rightarrow \infty
 \end{array}$$

---

The 0-a range, the mass flow rate is constant because the flow is choked at the nozzle. The entrance Mach number,  $M_1$  is constant because it is a function of the nozzle design only. The exit Mach number,  $M_2$  decreases (remember this flow is on the supersonic branch) and starts ( $\frac{4fL}{D} = 0$ ) as  $M_2 = M_1$ . At the end of the range a,  $M_2 = 1$ . In the range of a – b the flow is all supersonic.

In the next range a – b the flow is double choked and make the adjustment for the flow rate at different choking points by changing the shock location. The mass flow rate continues to be constant. The entrance Mach continues to be constant and exit Mach number is constant.

The total maximum available for supersonic flow b – b',  $\left(\frac{4fL}{D}\right)_{max}$ , is only a theoretical length in which the supersonic flow can occur if nozzle is provided with a larger Mach number (a change to the nozzle area ratio which also reduces the mass flow rate). In the range b – c, it is a more practical point.

In semi supersonic flow b – c (in which no supersonic is available in the tube but only in the nozzle) the flow is still double choked and the mass flow rate is constant. Notice that exit Mach number,  $M_2$  is still one. However, the entrance Mach number,  $M_1$ , reduces with the increase of  $\frac{4fL}{D}$ .

It is worth noticing that in the a – c the mass flow rate nozzle entrance velocity and the exit velocity remains constant!<sup>29</sup>

In the last range c –  $\infty$  the end is really the pressure limit or the break of the model and the isothermal model is more appropriate to describe the flow. In this range, the flow rate decreases since ( $\dot{m} \propto M_1$ )<sup>30</sup>.

To summarize the above discussion, Figures (11.25) exhibits the development of  $M_1$ ,  $M_2$  mass flow rate as a function of  $\frac{4fL}{D}$ . Somewhat different then the subsonic branch the mass flow rate is constant even if the flow in the tube is completely subsonic. This situation is because of the “double” choked condition in the nozzle. The exit Mach

<sup>29</sup>On a personal note, this situation is rather strange to explain. On one hand, the resistance increases and on the other hand, the exit Mach number remains constant and equal to one. Does anyone have an explanation for this strange behavior suitable for non-engineers or engineers without background in fluid mechanics?

<sup>30</sup>Note that  $\rho_1$  increases with decreases of  $M_1$  but this effect is less significant.

$M_2$  is a continuous monotonic function that decreases with  $\frac{4fL}{D}$ . The entrance Mach  $M_1$  is a non continuous function with a jump at the point when shock occurs at the entrance "moves" into the nozzle.

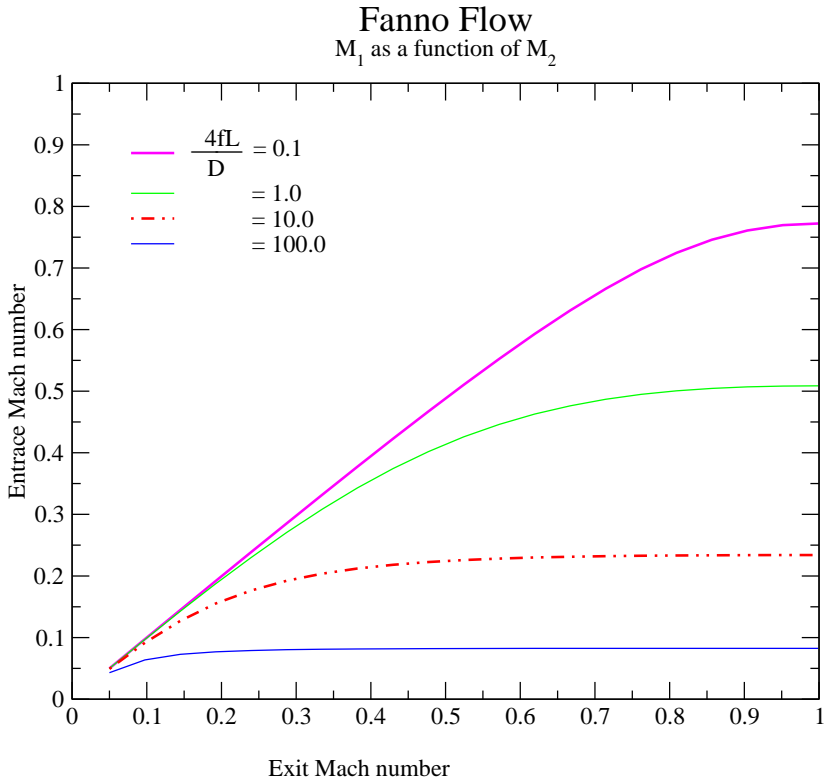

Tue Oct 19 09:56:15 2004

Fig. -11.26.  $M_1$  as a function  $M_2$  for various  $\frac{4fL}{D}$ .

Figure 11.26 exhibits the  $M_1$  as a function of  $M_2$ . The Figure was calculated by utilizing the data from Figure (11.20) by obtaining the  $\frac{4fL}{D}\Big|_{max}$  for  $M_2$  and subtracting the given  $\frac{4fL}{D}$  and finding the corresponding  $M_1$ .

The Figure (11.27) exhibits the entrance Mach number as a function of the  $M_2$ . Obviously there can be two extreme possibilities for the subsonic exit branch. Subsonic velocity occurs for supersonic entrance velocity, one, when the shock wave occurs at the tube exit and two, at the tube entrance. In Figure (11.27) only for  $\frac{4fL}{D} = 0.1$  and  $\frac{4fL}{D} = 0.4$  two extremes are shown. For  $\frac{4fL}{D} = 0.2$  shown with only shock at the exit only. Obviously, and as can be observed, the larger  $\frac{4fL}{D}$  creates larger differences between exit Mach number for the different shock locations. The larger  $\frac{4fL}{D}$  larger  $M_1$

### Fanno Flow

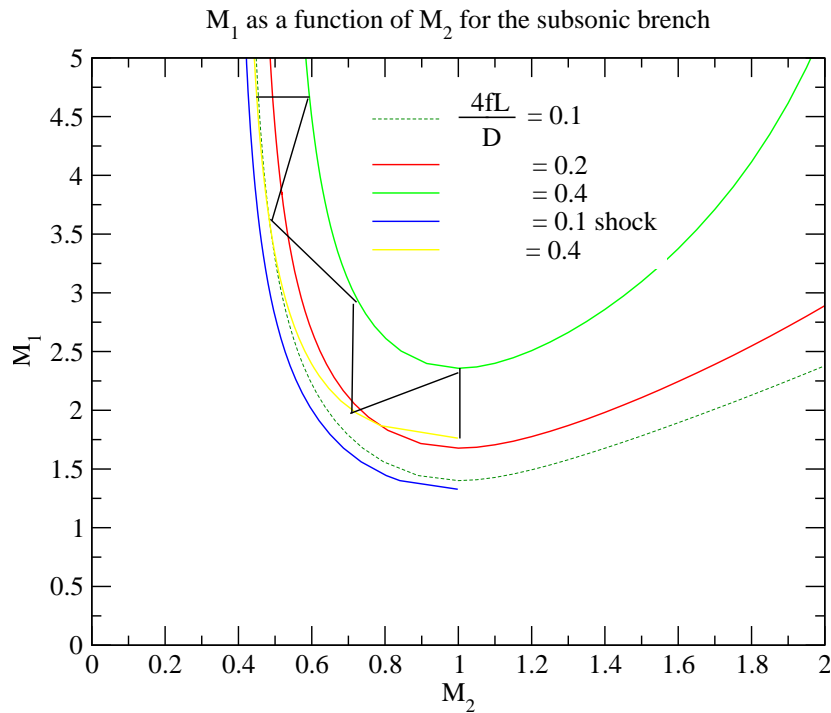

Tue Jan 4 11:26:19 2005

Fig. -11.27.  $M_1$  as a function  $M_2$  for different  $\frac{4fL}{D}$  for supersonic entrance velocity.

must occur even for shock at the entrance.

For a given  $\frac{4fL}{D}$ , below the maximum critical length, the supersonic entrance flow has three different regimes which depends on the back pressure. One, shockless flow, two, shock at the entrance, and three, shock at the exit. Below, the maximum critical length is mathematically

$$\frac{4fL}{D} > -\frac{1}{k} + \frac{1+k}{2k} \ln\left(\frac{k+1}{k-1}\right)$$

For cases of  $\frac{4fL}{D}$  above the maximum critical length no supersonic flow can be over the whole tube and at some point a shock will occur and the flow becomes subsonic flow<sup>31</sup>.

<sup>31</sup>See more on the discussion about changing the length of the tube.

### 11.7.7 The Pressure Ratio, $P_2/P_1$ , effects

In this section the studied parameter is the variation of the back pressure and thus, the pressure ratio ( $P_2/P_1$ ) variations. For very low pressure ratio the flow can be assumed as incompressible with exit Mach number smaller than  $< 0.3$ . As the pressure ratio increases (smaller back pressure,  $P_2$ ), the exit and entrance Mach numbers increase. According to Fanno model the value of  $\frac{4fL}{D}$  is constant (friction factor,  $f$ , is independent of the parameters such as, Mach number, Reynolds number et cetera) thus the flow remains on the same Fanno line. For cases where the supply come from a reservoir with a constant pressure, the entrance pressure decreases as well because of the increase in the entrance Mach number (velocity).

Again a differentiation of the feeding is important to point out. If the feeding nozzle is converging than the flow will be only subsonic. If the nozzle is “converging-diverging” than in some part supersonic flow is possible. At first the converging nozzle is presented and later the converging-diverging nozzle is explained.

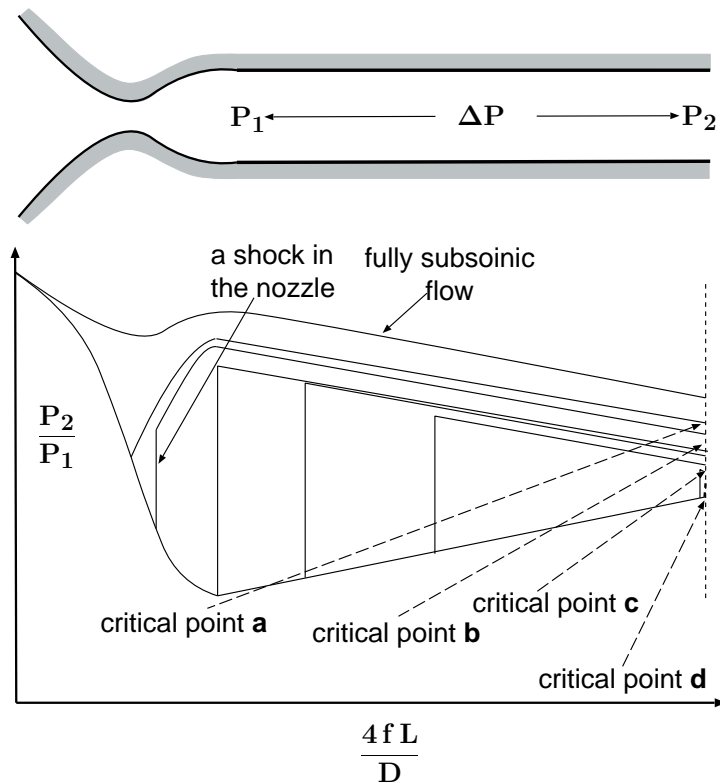

Fig. -11.28. The pressure distribution as a function of  $\frac{4fL}{D}$  for a short  $\frac{4fL}{D}$ .

11.7.7.1 Choking explanation for pressure variation/reduction

Decreasing the pressure ratio or in actuality the back pressure, results in increase of the entrance and the exit velocity until a maximum is reached for the exit velocity. The maximum velocity is when exit Mach number equals one. The Mach number, as it was shown in Chapter (??), can increase only if the area increase. In our model the tube area is postulated as a constant therefore the velocity cannot increase any further. However, for the flow to be continuous the pressure must decrease and for that the velocity must increase. Something must break since there are conflicting demands and it result in a “jump” in the flow. This jump is referred to as a choked flow. Any additional reduction in the back pressure will not change the situation in the tube. The only change will be at tube surroundings which are irrelevant to this discussion.

If the feeding nozzle is a “converging-diverging” then it has to be differentiated between two cases; One case is where the  $\frac{4fL}{D}$  is short or equal to the critical length. The critical length is the maximum  $\frac{4fL}{D} \Big|_{max}$  that associate with entrance Mach number.

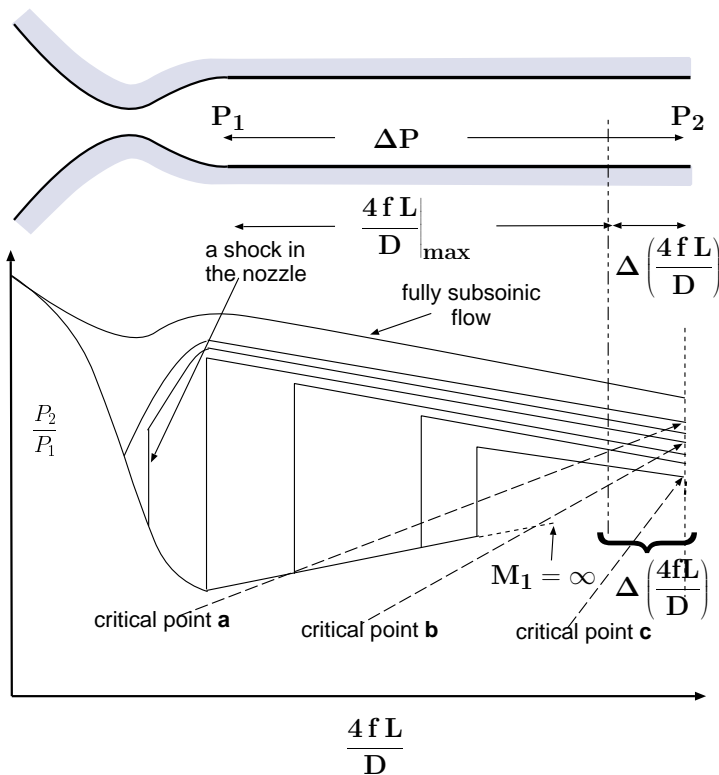

Fig. -11.29. The pressure distribution as a function of  $\frac{4fL}{D}$  for a long  $\frac{4fL}{D}$ .

### 11.7.7.2 Short $4fL/D$

Figure 11.29 shows different pressure profiles for different back pressures. Before the flow reaches critical point **a** (in the Figure 11.29) the flow is subsonic. Up to this stage the nozzle feeding the tube increases the mass flow rate (with decreasing back pressure). Pressure between point **a** and point **b** the shock is in the nozzle. In this range and further reduction of the pressure the mass flow rate is constant no matter how low the back pressure is reduced. Once the back pressure is less than point **b** the supersonic reaches to the tube. Note however that exit Mach number,  $M_2 < 1$  and is **not** 1. A back pressure that is at the critical point **c** results in a shock wave that is at the exit. When the back pressure is below point **c**, the tube is “clean” of any shock<sup>32</sup>. The back pressure below point **c** has some adjustment as it occurs with exceptions of point **d**.

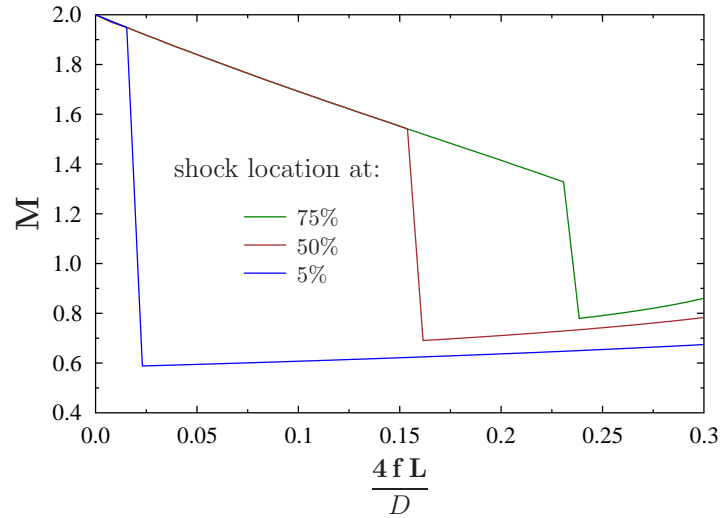

Fig. -11.30. The effects of pressure variations on Mach number profile as a function of  $\frac{4fL}{D}$  when the total resistance  $\frac{4fL}{D} = 0.3$  for Fanno Flow.

### 11.7.7.3 Long $\frac{4fL}{D}$

In the case of  $\frac{4fL}{D} > \left. \frac{4fL}{D} \right|_{max}$  reduction of the back pressure results in the same process as explained in the short  $\frac{4fL}{D}$  up to point **c**. However, point **c** in this case is different from point **c** at the case of short tube  $\frac{4fL}{D} < \left. \frac{4fL}{D} \right|_{max}$ . In this point the exit Mach number is equal to 1 and the flow is double shock. Further reduction of the

<sup>32</sup>It is common misconception that the back pressure has to be at point **d**.



back pressure at this stage will not “move” the shock wave downstream the nozzle. At point **c** or location of the shock wave, is a function entrance Mach number,  $M_1$  and the “extra”  $\frac{4fL}{D}$ . There is no analytical solution for the location of this point **c**. The procedure is (will be) presented in later stage.

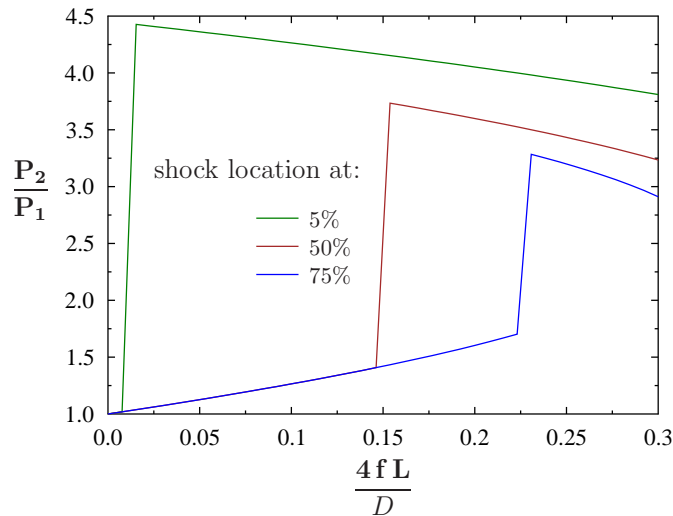

Fig. -11.31. Pressure ratios as a function of  $\frac{4fL}{D}$  when the total  $\frac{4fL}{D} = 0.3$ .

### The Maximum Location of the Shock

The main point in this discussion however, is to find the furthest shock location downstream. Figure (??) shows the possible  $\Delta \left( \frac{4fL}{D} \right)$  as a function of retreat of the location of the shock wave from the maximum location. When the entrance Mach number is infinity,  $M_1 = \infty$ , if the shock location is at the maximum length, then shock at  $M_x = 1$  results in  $M_y = 1$ .

The proposed procedure is based on Figure ??.

- i) Calculate the extra  $\frac{4fL}{D}$  and subtract the actual extra  $\frac{4fL}{D}$  assuming shock at the left side (at the max length).
- ii) Calculate the extra  $\frac{4fL}{D}$  and subtract the actual extra  $\frac{4fL}{D}$  assuming shock at the right side (at the entrance).
- iii) According to the positive or negative utilizes your root finding procedure.

From numerical point of view, the Mach number equal infinity when left side assumes result in infinity length of possible extra (the whole flow in the tube is subsonic). To overcome this numerical problem, it is suggested to start the calculation from  $\epsilon$  distance from the right hand side.

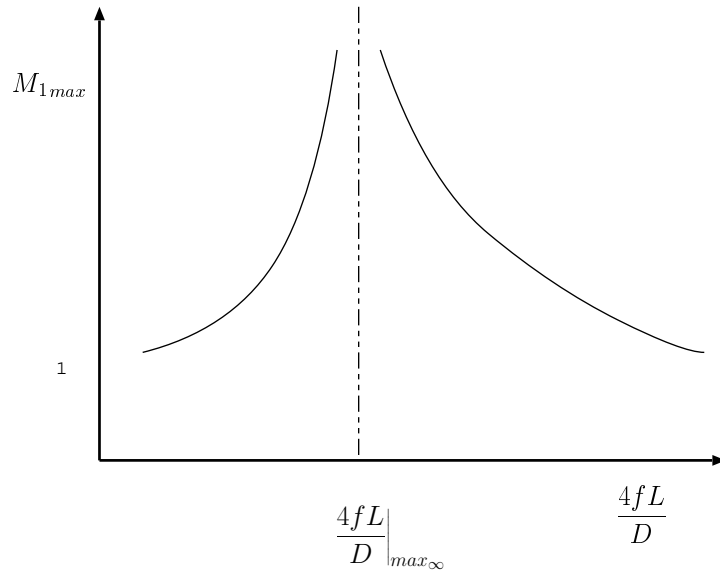

Fig. -11.32. The maximum entrance Mach number,  $M_1$  to the tube as a function of  $\frac{4fL}{D}$  supersonic branch.

Let denote

$$\Delta\left(\frac{4fL}{D}\right) = \frac{4\bar{f}L}{D}|_{actual} - \frac{4fL}{D}|_{sup} \quad (11.204)$$

Note that  $\frac{4fL}{D}|_{sup}$  is smaller than  $\frac{4\bar{f}L}{D}|_{max\infty}$ . The requirement that has to be satisfied is that denote  $\frac{4fL}{D}|_{retreat}$  as difference between the maximum possible of length in which the supersonic flow is achieved and the actual length in which the flow is supersonic see Figure 11.32. The retreating length is expressed as subsonic but

$$\frac{4fL}{D}|_{retreat} = \frac{4\bar{f}L}{D}|_{max\infty} - \frac{4fL}{D}|_{sup} \quad (11.205)$$

Figure 11.32 shows the entrance Mach number,  $M_1$  reduces after the maximum length is exceeded.

**Example 11.20:**

Calculate the shock location for entrance Mach number  $M_1 = 8$  and for  $\frac{4fL}{D} = 0.9$  assume that  $k = 1.4$  ( $M_{exit} = 1$ ).

SOLUTION

The solution is obtained by an iterative process. The maximum  $\left. \frac{4fL}{D} \right|_{max}$  for  $k = 1.4$  is 0.821508116. Hence,  $\frac{4fL}{D}$  exceed the maximum length  $\frac{4fL}{D}$  for this entrance Mach number. The maximum for  $M_1 = 8$  is  $\frac{4fL}{D} = 0.76820$ , thus the extra tube is  $\Delta \left( \frac{4fL}{D} \right) = 0.9 - 0.76820 = 0.1318$ . The left side is when the shock occurs at  $\frac{4fL}{D} = 0.76820$  (flow is choked and no additional  $\frac{4fL}{D}$ ). Hence, the value of left side is  $-0.1318$ . The right side is when the shock is at the entrance at which the extra  $\frac{4fL}{D}$  is calculated for  $M_x$  and  $M_y$  is

$M_x$	$M_y$	$\frac{T_y}{T_x}$	$\frac{\rho_y}{\rho_x}$	$\frac{P_y}{P_x}$	$\frac{P_{0y}}{P_{0x}}$
8.0000	0.39289	13.3867	5.5652	74.5000	0.00849

With  $(M_1)'$

M	$\frac{4fL}{D}$	$\frac{P}{P^*}$	$\frac{P_0}{P_0^*}$	$\frac{\rho}{\rho^*}$	$\frac{U}{U^*}$	$\frac{T}{T^*}$
0.39289	2.4417	2.7461	1.6136	2.3591	0.42390	1.1641

The extra  $\Delta \left( \frac{4fL}{D} \right)$  is  $2.442 - 0.1318 = 2.3102$  Now the solution is somewhere between the negative of left side to the positive of the right side<sup>33</sup>.

In a summary of the actions is done by the following algorithm:

- check if the  $\frac{4fL}{D}$  exceeds the maximum  $\frac{4fL}{D}_{max}$  for the supersonic flow. Accordingly continue.
- Guess  $\frac{4fL}{D}_{up} = \frac{4fL}{D} - \frac{4fL}{D} \Big|_{max}$
- Calculate the Mach number corresponding to the current guess of  $\frac{4fL}{D}_{up}$ ,
- Calculate the associate Mach number,  $M_x$  with the Mach number,  $M_y$  calculated previously,
- Calculate  $\frac{4fL}{D}$  for supersonic branch for the  $M_x$
- Calculate the "new and improved"  $\frac{4fL}{D}_{up}$
- Compute the "new  $\frac{4fL}{D}_{down} = \frac{4fL}{D} - \frac{4fL}{D}_{up}$
- Check the new and improved  $\frac{4fL}{D} \Big|_{down}$  against the old one. If it is satisfactory stop or return to stage (b).

<sup>33</sup>What if the right side is also negative? The flow is choked and shock must occur in the nozzle before entering the tube. Or in a very long tube the whole flow will be subsonic.

Shock location are:

$M_1$	$M_2$	$\frac{4fL}{D} _{up}$	$\frac{4fL}{D} _{down}$	$M_x$	$M_y$
8.0000	1.0000	0.57068	0.32932	1.6706	0.64830

The iteration summary is also shown below

i	$\frac{4fL}{D} _{up}$	$\frac{4fL}{D} _{down}$	$M_x$	$M_y$	$\frac{4fL}{D}$
0	0.67426	0.22574	1.3838	0.74664	0.90000
1	0.62170	0.27830	1.5286	0.69119	0.90000
2	0.59506	0.30494	1.6021	0.66779	0.90000
3	0.58217	0.31783	1.6382	0.65728	0.90000
4	0.57605	0.32395	1.6554	0.65246	0.90000
5	0.57318	0.32682	1.6635	0.65023	0.90000
6	0.57184	0.32816	1.6673	0.64920	0.90000
7	0.57122	0.32878	1.6691	0.64872	0.90000
8	0.57093	0.32907	1.6699	0.64850	0.90000
9	0.57079	0.32921	1.6703	0.64839	0.90000
10	0.57073	0.32927	1.6705	0.64834	0.90000
11	0.57070	0.32930	1.6706	0.64832	0.90000
12	0.57069	0.32931	1.6706	0.64831	0.90000
13	0.57068	0.32932	1.6706	0.64831	0.90000
14	0.57068	0.32932	1.6706	0.64830	0.90000
15	0.57068	0.32932	1.6706	0.64830	0.90000
16	0.57068	0.32932	1.6706	0.64830	0.90000
17	0.57068	0.32932	1.6706	0.64830	0.90000

This procedure rapidly converted to the solution.

### 11.7.8 The Practical Questions and Examples of Subsonic branch

The Fanno is applicable also when the flow isn't choke<sup>34</sup>. In this case, several questions appear for the subsonic branch. This is the area shown in Figure (11.25) in beginning for between points 0 and *a*. This kind of questions made of pair given information to find the conditions of the flow, as oppose to only one piece of information given in choked flow. There many combinations that can appear in this situation but there are several more physical and practical that will be discussed here.

### 11.7.9 Subsonic Fanno Flow for Given $\frac{4fL}{D}$ and Pressure Ratio

This pair of parameters is the most natural to examine because, in most cases, this information is the only provided information. For a given pipe ( $\frac{4fL}{D}$ ), neither the entrance Mach number nor the exit Mach number are given (sometimes the entrance Mach number is given see the next section). There is no known exact analytical solution. There are two possible approaches to solve this problem: one, by building a representative function and find a root (or roots) of this representative function. Two, the problem can be solved by an iterative procedure. The first approach require using root finding method and either method of spline method or the half method or the combination of the two. In the past, this book advocated the integrative method. Recently, this author investigate proposed an improved method.

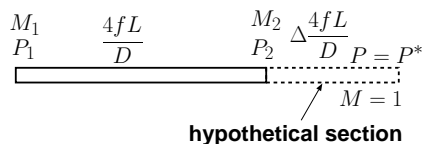

Fig. -11.33. Unchoked flow calculations showing the hypothetical "full" tube when choked

This method is based on the entrance Mach number as the base. The idea based on the idea that the pressure ratio can be drawn as a function of the entrance Mach number. One of difficulties lays in the determination the boundaries of the entrance Mach number. The maximum entrance Mach number is chocking Mach number. The lower possible Mach number is zero which creates very large  $\frac{4fL}{D}$ . The equations are solve for these large  $\frac{4fL}{D}$  numbers by perturbation method and the analytical solution is

$$M_1 = \sqrt{\frac{1 - \left[\frac{P_2}{P_0}\right]^2}{k \frac{4fL}{D}}} \tag{11.206}$$

Equation (11.206) is suggested to be used up to  $M_1 < 0.02$ . To have small overlapping zone the lower boundary is  $M_1 < 0.01$ .

<sup>34</sup>These questions were raised from many who didn't find any book that discuss these practical aspects and send the questions to this author.

The process is based on finding the pressure ratio for given  $\frac{4fL}{D}$  pipe dimensionless length. Figure 11.34 exhibits the pressure ratio for fix  $\frac{4fL}{D}$  as function of the entrance Mach number. As it can be observed, the entrance Mach number lays between zero and the maximum of the choking conditions. For example for a fixed pipe,  $\frac{4fL}{D} = 1$  the maximum Mach number is 0.50874 as shown in Figure 11.34 by orange line. For a given entrance Mach number, the pressure ratio,  $P_1/P^*$  and  $\left.\frac{4fL}{D}\right|_1$  can be calculated. The exit pipe length,  $\left.\frac{4fL}{D}\right|_2$  is obtained by subtracting the fix length  $\frac{4fL}{D}$  from  $\left.\frac{4fL}{D}\right|_1$ . With this value, the exit Mach number,  $M_2$  and pressure ratio  $P_2/P^*$  are calculated. Hence the pressure ratio,  $P_2/P_1$  can be obtained and is drawn in Figure 11.34.

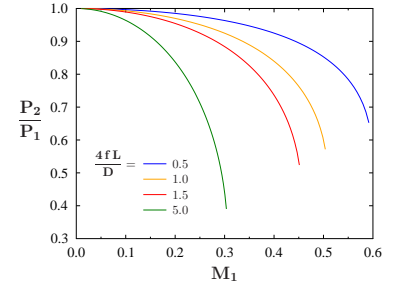

Fig. -11.34. Pressure ratio obtained for a fix  $\frac{4fL}{D}$  as a function of Mach number for  $k=1.4$ .

Hence, when the pressure ratio,  $P_2/P_1$  is given along with given pipe,  $\frac{4fL}{D}$  the solution can be obtained by drawing a horizontal line. The intersection of the horizontal line with the right curve of the pressure ratio yields the entrance Mach number. This can be done by a computer program such Potto-GDC (version 0.5.2 and above). The summary of the procedure is as the following.

- 1) If the pressure ratio is  $P_2/P_1 < 0.02$  then using the perturbed solution the entrance Mach number is very small and calculate using the formula

$$M = \sqrt{\left(1 - \frac{P_2/P_1}{k \left(\frac{4fL}{D}\right)}\right)} \quad (11.207)$$

If the pressure ratio smaller than continue with the following.

- 2) Calculate the  $\left.\frac{4fL}{D}\right|_1$  for  $M_1 = 0.01$
- 3) Subtract the given  $\frac{4fL}{D}$  from  $\left.\frac{4fL}{D}\right|_1$  and calculate the exit Mach number.
- 4) Calculate the pressure ratio.
- 5) Calculate the pressure ratio for choking condition (given  $\frac{4fL}{D}$ ).
- 6) Use your favorite to method to calculate root finding (In potto-GDC Brent's method is used)

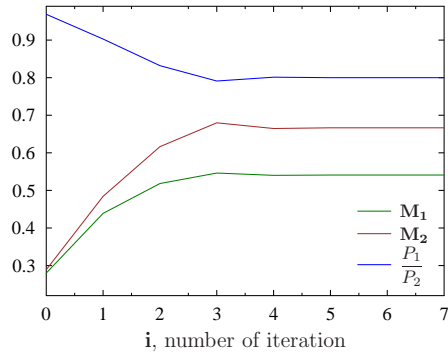

Fig. -11.35. Conversion of solution for given  $\frac{4fL}{D} = 0.5$  and pressure ratio equal 0.8.

Example runs is presented in the Figure 11.35 for  $\frac{4fL}{D} = 0.5$  and pressure ratio equal to 0.8. The blue line in Figure 11.34 intersection with the horizontal line of  $P_2/P_1 = 0.8$  yield the solution of  $M \sim 0.5$ . The whole solution obtained in 7 iterations with accuracy of  $10^{-12}$ .

In Potto–GDC there is another older iterative method used to solve constructed on the properties of several physical quantities must be in a certain range. The first fact is that the pressure ratio  $P_2/P_1$  is always between 0 and 1 (see Figure 11.33). In the figure, a theoretical extra tube is added in such a length that cause the flow to choke (if it really was there). This length is always positive (at minimum is zero).

The procedure for the calculations is as the following:

- 1) Calculate the entrance Mach number,  $M_1'$  assuming the  $\frac{4fL}{D} = \frac{4fL}{D} \Big|_{max}'$  (choked flow);  
Calculate the minimum pressure ratio  $(P_2/P_1)_{min}$  for  $M_1'$  (look at table (11.6))
- 2) Check if the flow is choked:  
There are two possibilities to check it.
  - a) Check if the given  $\frac{4fL}{D}$  is smaller than  $\frac{4fL}{D}$  obtained from the given  $P_1/P_2$ , or
  - b) check if the  $(P_2/P_1)_{min}$  is larger than  $(P_2/P_1)$ ,
 continue if the criteria is satisfied. Or if not satisfied abort this procedure and continue to calculation for choked flow.
- 3) Calculate the  $M_2$  based on the  $(P^*/P_2) = (P_1/P_2)$ ,
- 4) calculate  $\Delta \frac{4fL}{D}$  based on  $M_2$ ,

- 5) calculate the new  $(P_2/P_1)$ , based on the new  $f \left( \left( \frac{4fL}{D} \right)_1, \left( \frac{4fL}{D} \right)_2 \right)$ ,  
(remember that  $\Delta \frac{4fL}{D} = \left( \frac{4fL}{D} \right)_2$ ),
- 6) calculate the corresponding  $M_1$  and  $M_2$ ,
- 7) calculate the new and “improve” the  $\Delta \frac{4fL}{D}$  by

$$\left( \Delta \frac{4fL}{D} \right)_{new} = \left( \Delta \frac{4fL}{D} \right)_{old} * \frac{\left( \frac{P_2}{P_1} \right)_{given}}{\left( \frac{P_2}{P_1} \right)_{old}} \quad (11.208)$$

Note, when the pressure ratios are matching also the  $\Delta \frac{4fL}{D}$  will also match.

- 8) Calculate the “improved/new”  $M_2$  based on the improve  $\Delta \frac{4fL}{D}$
- 9) calculate the improved  $\frac{4fL}{D}$  as  $\frac{4fL}{D} = \left( \frac{4fL}{D} \right)_{given} + \Delta \left( \frac{4fL}{D} \right)_{new}$
- 10) calculate the improved  $M_1$  based on the improved  $\frac{4fL}{D}$ .
- 11) Compare the abs  $((P_2/P_1)_{new} - (P_2/P_1)_{old})$  and if not satisfied returned to stage (5) until the solution is obtained.

To demonstrate how this procedure is working consider a typical example of  $\frac{4fL}{D} = 1.7$  and  $P_2/P_1 = 0.5$ . Using the above algorithm the results are exhibited in the following figure.

Figure 11.36 demonstrates that the conversion occur at about 7-8 iterations. With better first guess this conversion procedure converts much faster but at certain range it is unstable.

### 11.7.10 Subsonic Fanno Flow for a Given $M_1$ and Pressure Ratio

This situation pose a simple mathematical problem while the physical situation occurs in cases where a specific flow rate is required with a given pressure ratio (range) (this problem was considered by some to be somewhat complicated). The specific flow rate can be converted to entrance Mach number and this simplifies the problem. Thus, the problem is reduced to find for given entrance Mach,  $M_1$ , and given pressure ratio calculate the flow parameters, like the exit Mach number,  $M_2$ . The procedure is based on the fact that the entrance star pressure ratio can be calculated using  $M_1$ . Thus, using the pressure ratio to calculate the star exit pressure ratio provide the exit Mach number,  $M_2$ . An example of such issue is the following example that combines also the “Naughty professor” problems.

#### Example 11.21:

Calculate the exit Mach number for  $P_2/P_1 = 0.4$  and entrance Mach number  $M_1 = 0.25$ .



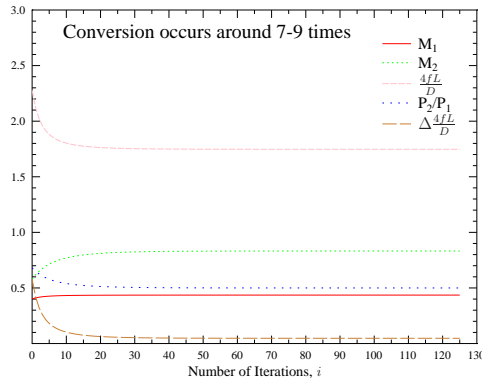

October 8, 2007

Fig. -11.36. The results of the algorithm showing the conversion rate for unchoked Fanno flow model with a given  $\frac{4fL}{D}$  and pressure ratio.

SOLUTION

The star pressure can be obtained from a table or Potto-GDC as

M	$\frac{4fL}{D}$	$\frac{P}{P^*}$	$\frac{P_0}{P_0^*}$	$\frac{\rho}{\rho^*}$	$\frac{U}{U^*}$	$\frac{T}{T^*}$
0.25000	8.4834	4.3546	2.4027	3.6742	0.27217	1.1852

And the star pressure ratio can be calculated at the exit as following

$$\frac{P_2}{P^*} = \frac{P_2}{P_1} \frac{P_1}{P^*} = 0.4 \times 4.3546 = 1.74184$$

And the corresponding exit Mach number for this pressure ratio reads

M	$\frac{4fL}{D}$	$\frac{P}{P^*}$	$\frac{P_0}{P_0^*}$	$\frac{\rho}{\rho^*}$	$\frac{U}{U^*}$	$\frac{T}{T^*}$
0.60694	0.46408	1.7418	1.1801	1.5585	0.64165	1.1177

A bit show off the Potto-GDC can carry these calculations in one click as

M <sub>1</sub>	M <sub>2</sub>	$\frac{4fL}{D}$	$\frac{P_2}{P_1}$
0.25000	0.60693	8.0193	0.40000

### 11.7.11 More Examples of Fanno Flow

Example 11.22:

To demonstrate the utility in Figure (??) consider the following example. Find the mass flow rate for  $f = 0.05$ ,  $L = 4[m]$ ,  $D = 0.02[m]$  and pressure ratio  $P_2/P_1 = 0.1, 0.3, 0.5, 0.8$ . The stagnation conditions at the entrance are  $300K$  and  $3[bar]$  air.

SOLUTION

First calculate the dimensionless resistance,  $\frac{4fL}{D}$ .

$$\frac{4fL}{D} = \frac{4 \times 0.05 \times 4}{0.02} = 40$$

From Figure ?? for  $P_2/P_1 = 0.1$   $M_1 \approx 0.13$  etc.

or accurately by utilizing the program as in the following table.

$M_1$	$M_2$	$\frac{4fL}{D}$	$\frac{4fL}{D} _1$	$\frac{4fL}{D} _2$	$\frac{P_2}{P_1}$
0.12728	1.0000	40.0000	40.0000	0.0	0.11637
0.12420	0.40790	40.0000	42.1697	2.1697	0.30000
0.11392	0.22697	40.0000	50.7569	10.7569	0.50000
0.07975	0.09965	40.0000	107.42	67.4206	0.80000

Only for the pressure ratio of 0.1 the flow is choked.

$M$	$\frac{T}{T_0}$	$\frac{\rho}{\rho_0}$	$\frac{A}{A^*}$	$\frac{P}{P_0}$	$\frac{A \times P}{A^* \times P_0}$
0.12728	0.99677	0.99195	4.5910	0.98874	4.5393
0.12420	0.99692	0.99233	4.7027	0.98928	4.6523
0.11392	0.99741	0.99354	5.1196	0.99097	5.0733
0.07975	0.99873	0.99683	7.2842	0.99556	7.2519

Therefore,  $T \approx T_0$  and is the same for the pressure. Hence, the mass rate is a function of the Mach number. The Mach number is indeed a function of the pressure ratio but mass flow rate is a function of pressure ratio only through Mach number.

The mass flow rate is

$$\dot{m} = PAM \sqrt{\frac{k}{RT}} = 300000 \times \frac{\pi \times 0.02^2}{4} \times 0.127 \times \sqrt{\frac{1.4}{287300}} \approx 0.48 \left( \frac{kg}{sec} \right)$$

and for the rest

$$\dot{m} \left( \frac{P_2}{P_1} = 0.3 \right) \sim 0.48 \times \frac{0.1242}{0.1273} = 0.468 \left( \frac{kg}{sec} \right)$$

$$\dot{m} \left( \frac{P_2}{P_1} = 0.5 \right) \sim 0.48 \times \frac{0.1139}{0.1273} = 0.43 \left( \frac{kg}{sec} \right)$$

$$\dot{m} \left( \frac{P_2}{P_1} = 0.8 \right) \sim 0.48 \times \frac{0.07975}{0.1273} = 0.30 \left( \frac{kg}{sec} \right)$$

---

End Solution

---

## 11.8 The Table for Fanno Flow

Table -11.6. Fanno Flow Standard basic Table  $k=1.4$

M	$\frac{4fL}{D}$	$\frac{P}{P^*}$	$\frac{P_0}{P_0^*}$	$\frac{\rho}{\rho^*}$	$\frac{U}{U^*}$	$\frac{T}{T^*}$
0.03	787.08	36.5116	19.3005	30.4318	0.03286	1.1998
0.04	440.35	27.3817	14.4815	22.8254	0.04381	1.1996
0.05	280.02	21.9034	11.5914	18.2620	0.05476	1.1994
0.06	193.03	18.2508	9.6659	15.2200	0.06570	1.1991
0.07	140.66	15.6416	8.2915	13.0474	0.07664	1.1988
0.08	106.72	13.6843	7.2616	11.4182	0.08758	1.1985
0.09	83.4961	12.1618	6.4613	10.1512	0.09851	1.1981
0.10	66.9216	10.9435	5.8218	9.1378	0.10944	1.1976
0.20	14.5333	5.4554	2.9635	4.5826	0.21822	1.1905
0.25	8.4834	4.3546	2.4027	3.6742	0.27217	1.1852
0.30	5.2993	3.6191	2.0351	3.0702	0.32572	1.1788
0.35	3.4525	3.0922	1.7780	2.6400	0.37879	1.1713
0.40	2.3085	2.6958	1.5901	2.3184	0.43133	1.1628
0.45	1.5664	2.3865	1.4487	2.0693	0.48326	1.1533
0.50	1.0691	2.1381	1.3398	1.8708	0.53452	1.1429
0.55	0.72805	1.9341	1.2549	1.7092	0.58506	1.1315
0.60	0.49082	1.7634	1.1882	1.5753	0.63481	1.1194

Table -11.6. Fanno Flow Standard basic Table (continue)

M	$\frac{4fL}{D}$	$\frac{P}{P^*}$	$\frac{P_0}{P_0^*}$	$\frac{\rho}{\rho^*}$	$\frac{U}{U^*}$	$\frac{T}{T^*}$
0.65	0.32459	1.6183	1.1356	1.4626	0.68374	1.1065
0.70	0.20814	1.4935	1.0944	1.3665	0.73179	1.0929
0.75	0.12728	1.3848	1.0624	1.2838	0.77894	1.0787
0.80	0.07229	1.2893	1.0382	1.2119	0.82514	1.0638
0.85	0.03633	1.2047	1.0207	1.1489	0.87037	1.0485
0.90	0.01451	1.1291	1.0089	1.0934	0.91460	1.0327
0.95	0.00328	1.061	1.002	1.044	0.95781	1.017
1.00	0.0	1.00000	1.000	1.000	1.00	1.000
2.00	0.30500	0.40825	1.688	0.61237	1.633	0.66667
3.00	0.52216	0.21822	4.235	0.50918	1.964	0.42857
4.00	0.63306	0.13363	10.72	0.46771	2.138	0.28571
5.00	0.69380	0.089443	25.00	0.44721	2.236	0.20000
6.00	0.72988	0.063758	53.18	0.43568	2.295	0.14634
7.00	0.75280	0.047619	1.0E+2	0.42857	2.333	0.11111
8.00	0.76819	0.036860	1.9E+2	0.42390	2.359	0.086957
9.00	0.77899	0.029348	3.3E+2	0.42066	2.377	0.069767
10.00	0.78683	0.023905	5.4E+2	0.41833	2.390	0.057143
20.00	0.81265	0.00609	1.5E+4	0.41079	2.434	0.014815
25.00	0.81582	0.00390	4.6E+4	0.40988	2.440	0.00952
30.00	0.81755	0.00271	1.1E+5	0.40938	2.443	0.00663
35.00	0.81860	0.00200	2.5E+5	0.40908	2.445	0.00488
40.00	0.81928	0.00153	4.8E+5	0.40889	2.446	0.00374
45.00	0.81975	0.00121	8.6E+5	0.40875	2.446	0.00296
50.00	0.82008	0.000979	1.5E+6	0.40866	2.447	0.00240
55.00	0.82033	0.000809	2.3E+6	0.40859	2.447	0.00198

Table -11.6. Fanno Flow Standard basic Table (continue)

M	$\frac{4fL}{D}$	$\frac{P}{P^*}$	$\frac{P_0}{P_0^*}$	$\frac{\rho}{\rho^*}$	$\frac{U}{U^*}$	$\frac{T}{T^*}$
60.00	0.82052	0.000680	3.6E+6	0.40853	2.448	0.00166
65.00	0.82066	0.000579	5.4E+6	0.40849	2.448	0.00142
70.00	0.82078	0.000500	7.8E+6	0.40846	2.448	0.00122

## 11.9 Rayleigh Flow

Rayleigh flow is a model describing a frictionless flow with heat transfer through a pipe of constant cross sectional area. In practice, Rayleigh flow isn't a really good model to describe real situations. Yet, Rayleigh flow is practical and useful concept in a obtaining trends and limits such as the density and pressure change due to external cooling or heating. As opposed to the two previous models, the heat transfer can be in two directions not like the friction (there is no negative friction). This fact creates a different situation as compared to the previous two models. This model can be applied to cases where the heat transfer is significant and the friction can be ignored. Flow of steam in steam boiler is good example where Rayleigh flow can be used.

### 11.10 Introduction

The third simple model for 1-dimensional flow with a constant heat transfer for frictionless flow. This flow is referred to in the literature as Rayleigh Flow (see historical notes). This flow is another extreme case in which the friction effects are neglected because their relative magnitude is significantly smaller than the heat transfer effects. While the isothermal flow model has heat transfer and friction, the main assumption was that relative length is enables significant heat transfer to occur between the surroundings and tube. In contrast, the heat transfer in Rayleigh flow occurs between unknown temperature and the tube and the heat flux is maintained constant. As before, a simple model is built around the assumption of constant properties (poorer prediction to case where chemical reaction take a place).

This model is used to roughly predict the conditions which occur mostly in situations involving chemical reaction. In analysis of the flow, one has to be aware that properties do change significantly for a large range of temperatures. Yet, for smaller range of temperatures and lengths the calculations are more accurate. Nevertheless,

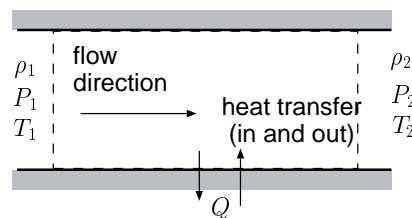

Fig. -11.37. The control volume of Rayleigh Flow.

the main characteristics of the flow such as a choking condition etc. are encapsulated in this model.

The basic physics of the flow revolves around the fact that the gas is highly compressible. The density changes through the heat transfer (temperature change). Contrary to Fanno flow in which the resistance always oppose the flow direction, Rayleigh flow, also, the cooling can be applied. The flow acceleration changes the direction when the cooling is applied.

### 11.10.1 Governing Equations

The energy balance on the control volume reads

$$Q = C_p (T_{02} - T_{01}) \quad (11.209)$$

The momentum balance reads

$$A(P_1 - P_2) = \dot{m}(V_2 - V_1) \quad (11.210)$$

The mass conservation reads

$$\rho_1 U_1 A = \rho_2 U_2 A = \dot{m} \quad (11.211)$$

Equation of state

$$\frac{P_1}{\rho_1 T_1} = \frac{P_2}{\rho_2 T_2} \quad (11.212)$$

There are four equations with four unknowns, if the upstream conditions are known (or downstream conditions are known). Thus, a solution can be obtained. One can notice that equations (11.210), (11.211) and (11.212) are similar to the equations that were solved for the shock wave. Thus, results in the same as before (11.84)

Pressure Ratio
$\frac{P_2}{P_1} = \frac{1 + k M_1^2}{1 + k M_2^2} \quad (11.213)$

The equation of state (11.212) can further assist in obtaining the temperature ratio as

$$\frac{T_2}{T_1} = \frac{P_2 \rho_1}{P_1 \rho_2} \quad (11.214)$$

The density ratio can be expressed in terms of mass conservation as

$$\frac{\rho_1}{\rho_2} = \frac{U_2}{U_1} = \frac{\frac{U_2}{\sqrt{k R T_2}} \sqrt{k R T_2}}{\frac{U_1}{\sqrt{k R T_1}} \sqrt{k R T_1}} = \frac{M_2 \sqrt{\frac{T_2}{T_1}}}{M_1} \quad (11.215)$$

or in simple terms as

$$\boxed{\text{Density Ratio}} \quad \frac{\rho_1}{\rho_2} = \frac{U_2}{U_1} = \frac{M_2}{M_1} \sqrt{\frac{T_2}{T_1}} \quad (11.216)$$

or substituting equations (11.213) and (11.216) into equation (11.214) yields

$$\frac{T_2}{T_1} = \frac{1 + k M_1^2}{1 + k M_2^2} \frac{M_2}{M_1} \sqrt{\frac{T_2}{T_1}} \quad (11.217)$$

Transferring the temperature ratio to the left hand side and squaring the results gives

$$\boxed{\text{Temperature Ratio}} \quad \frac{T_2}{T_1} = \left[ \frac{1 + k M_1^2}{1 + k M_2^2} \right]^2 \left( \frac{M_2}{M_1} \right)^2 \quad (11.218)$$

The Rayleigh line exhibits two possible maximums one for  $dT/ds = 0$  and for  $ds/dT = 0$ . The second maximum can be expressed as  $dT/ds = \infty$ . The second law is used to find the expression for the derivative.

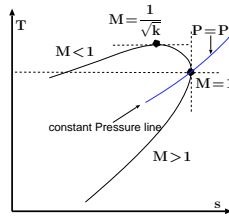

Fig. -11.38. The temperature entropy diagram for Rayleigh line.

$$\frac{s_1 - s_2}{C_p} = \ln \frac{T_2}{T_1} - \frac{k-1}{k} \ln \frac{P_2}{P_1} \quad (11.219)$$

$$\frac{s_1 - s_2}{C_p} = 2 \ln \left[ \left( \frac{1 + k M_1^2}{1 + k M_2^2} \right) \frac{M_2}{M_1} \right] + \frac{k-1}{k} \ln \left[ \frac{1 + k M_2^2}{1 + k M_1^2} \right] \quad (11.220)$$

Let the initial condition  $M_1$ , and  $s_1$  be constant and the variable parameters are  $M_2$ , and  $s_2$ . A derivative of equation (11.220) results in

$$\frac{1}{C_p} \frac{ds}{dM} = \frac{2(1 - M^2)}{M(1 + k M^2)} \quad (11.221)$$

Taking the derivative of equation (11.221) and letting the variable parameters be  $T_2$ , and  $M_2$  results in

$$\frac{dT}{dM} = \text{constant} \times \frac{1 - k M^2}{(1 + k M^2)^3} \quad (11.222)$$

Combining equations (11.221) and (11.222) by eliminating  $dM$  results in

$$\frac{dT}{ds} = \text{constant} \times \frac{M(1 - k M^2)}{(1 - M^2)(1 + k M^2)^2} \quad (11.223)$$

On  $T$ - $s$  diagram a family of curves can be drawn for a given constant. Yet for every curve, several observations can be generalized. The derivative is equal to zero when  $1 - kM^2 = 0$  or  $M = 1/\sqrt{k}$  or when  $M \rightarrow 0$ . The derivative is equal to infinity,  $dT/ds = \infty$  when  $M = 1$ . From thermodynamics, increase of heating results in increase of entropy. And cooling results in reduction of entropy. Hence, when cooling is applied to a tube the velocity decreases and when heating is applied the velocity increases. At peculiar point of  $M = 1/\sqrt{k}$  when additional heat is applied the temperature decreases. The derivative is negative,  $dT/ds < 0$ , yet note this point is not the choking point. The choking occurs only when  $M = 1$  because it violates the second law. The transition to supersonic flow occurs when the area changes, somewhat similarly to Fanno flow. Yet, choking can be explained by the fact that increase of energy must be accompanied by increase of entropy. But the entropy of supersonic flow is lower (see Figure 11.38) and therefore it is not possible (the maximum entropy at  $M = 1$ ).

It is convenient to refer to the value of  $M = 1$ . These values are referred to as the "star"<sup>35</sup> values. The equation (11.213) can be written between choking point and any point on the curve.

$$\boxed{\text{Pressure Ratio}} \quad \frac{P^*}{P_1} = \frac{1 + k M_1^2}{1 + k} \quad (11.224)$$

The temperature ratio is

$$\boxed{\text{Pressure Ratio}} \quad \frac{T^*}{T_1} = \frac{1}{M^2} \left( \frac{1 + k M_1^2}{1 + k} \right)^2 \quad (11.225)$$

The stagnation temperature can be expressed as

$$\frac{T_{01}}{T_0^*} = \frac{T_1 \left( 1 + \frac{k-1}{2} M_1^2 \right)}{T^* \left( \frac{1+k}{2} \right)} \quad (11.226)$$

or explicitly

$$\boxed{\text{Stagnation Temperature Ratio}} \quad \frac{T_{01}}{T_0^*} = \frac{2(1+k) M_1^2}{(1+k M^2)^2} \left( 1 + \frac{k-1}{2} M_1^2 \right) \quad (11.227)$$

The stagnation pressure ratio reads

$$\frac{P_{01}}{P_0^*} = \frac{P_1 \left( 1 + \frac{k-1}{2} M_1^2 \right)}{P^* \left( \frac{1+k}{2} \right)} \quad (11.228)$$

<sup>35</sup>The star is an asterisk.



or explicitly

Stagnation Pressure Ratio

$$\frac{P_{01}}{P_0^*} = \left( \frac{1+k}{1+kM_1^2} \right) \left( \frac{1+kM_1^2}{\frac{(1+k)}{2}} \right)^{\frac{k}{k-1}}$$

(11.229)

### 11.10.2 Rayleigh Flow Tables and Figures

The "star" values are tabulated in Table 11.7. Several observations can be made in regards to the stagnation temperature. The maximum temperature is not at Mach equal to one. Yet the maximum entropy occurs at Mach equal to one.

Table -11.7. Rayleigh Flow  $k=1.4$

M	$\frac{T}{T^*}$	$\frac{T_0}{T_0^*}$	$\frac{P}{P^*}$	$\frac{P_0}{P_0^*}$	$\frac{\rho^*}{\rho}$
0.03	0.00517	0.00431	2.397	1.267	0.00216
0.04	0.00917	0.00765	2.395	1.266	0.00383
0.05	0.014300	0.011922	2.392	1.266	0.00598
0.06	0.020529	0.017119	2.388	1.265	0.00860
0.07	0.027841	0.023223	2.384	1.264	0.011680
0.08	0.036212	0.030215	2.379	1.262	0.015224
0.09	0.045616	0.038075	2.373	1.261	0.019222
0.10	0.056020	0.046777	2.367	1.259	0.023669
0.20	0.20661	0.17355	2.273	1.235	0.090909
0.25	0.30440	0.25684	2.207	1.218	0.13793
0.30	0.40887	0.34686	2.131	1.199	0.19183
0.35	0.51413	0.43894	2.049	1.178	0.25096
0.40	0.61515	0.52903	1.961	1.157	0.31373
0.45	0.70804	0.61393	1.870	1.135	0.37865
0.50	0.79012	0.69136	1.778	1.114	0.44444
0.55	0.85987	0.75991	1.686	1.094	0.51001
0.60	0.91670	0.81892	1.596	1.075	0.57447
0.65	0.96081	0.86833	1.508	1.058	0.63713

Table -11.7. Rayleigh Flow  $k=1.4$  (continue)

M	$\frac{T}{T^*}$	$\frac{T_0}{T_0^*}$	$\frac{P}{P^*}$	$\frac{P_0}{P_0^*}$	$\frac{\rho^*}{\rho}$
0.70	0.99290	0.90850	1.423	1.043	0.69751
0.75	1.014	0.94009	1.343	1.030	0.75524
0.80	1.025	0.96395	1.266	1.019	0.81013
0.85	1.029	0.98097	1.193	1.011	0.86204
0.90	1.025	0.99207	1.125	1.005	0.91097
0.95	1.015	0.99814	1.060	1.001	0.95693
1.0	1.00	1.00	1.00	1.00	1.000
1.1	0.96031	0.99392	0.89087	1.005	1.078
1.2	0.91185	0.97872	0.79576	1.019	1.146
1.3	0.85917	0.95798	0.71301	1.044	1.205
1.4	0.80539	0.93425	0.64103	1.078	1.256
1.5	0.75250	0.90928	0.57831	1.122	1.301
1.6	0.70174	0.88419	0.52356	1.176	1.340
1.7	0.65377	0.85971	0.47562	1.240	1.375
1.8	0.60894	0.83628	0.43353	1.316	1.405
1.9	0.56734	0.81414	0.39643	1.403	1.431
2.0	0.52893	0.79339	0.36364	1.503	1.455
2.1	0.49356	0.77406	0.33454	1.616	1.475
2.2	0.46106	0.75613	0.30864	1.743	1.494
2.3	0.43122	0.73954	0.28551	1.886	1.510
2.4	0.40384	0.72421	0.26478	2.045	1.525
2.5	0.37870	0.71006	0.24615	2.222	1.538
2.6	0.35561	0.69700	0.22936	2.418	1.550
2.7	0.33439	0.68494	0.21417	2.634	1.561
2.8	0.31486	0.67380	0.20040	2.873	1.571

Table -11.7. Rayleigh Flow  $k=1.4$  (continue)

M	$\frac{T}{T^*}$	$\frac{T_0}{T_0^*}$	$\frac{P}{P^*}$	$\frac{P_0}{P_0^*}$	$\frac{\rho^*}{\rho}$
2.9	0.29687	0.66350	0.18788	3.136	1.580
3.0	0.28028	0.65398	0.17647	3.424	1.588
3.5	0.21419	0.61580	0.13223	5.328	1.620
4.0	0.16831	0.58909	0.10256	8.227	1.641
4.5	0.13540	0.56982	0.081772	12.50	1.656
5.0	0.11111	0.55556	0.066667	18.63	1.667
5.5	0.092719	0.54473	0.055363	27.21	1.675
6.0	0.078487	0.53633	0.046693	38.95	1.681
6.5	0.067263	0.52970	0.039900	54.68	1.686
7.0	0.058264	0.52438	0.034483	75.41	1.690
7.5	0.050943	0.52004	0.030094	1.0E+2	1.693
8.0	0.044910	0.51647	0.026490	1.4E+2	1.695
8.5	0.039883	0.51349	0.023495	1.8E+2	1.698
9.0	0.035650	0.51098	0.020979	2.3E+2	1.699
9.5	0.032053	0.50885	0.018846	3.0E+2	1.701
10.0	0.028972	0.50702	0.017021	3.8E+2	1.702
20.0	0.00732	0.49415	0.00428	1.1E+4	1.711
25.0	0.00469	0.49259	0.00274	3.2E+4	1.712
30.0	0.00326	0.49174	0.00190	8.0E+4	1.713
35.0	0.00240	0.49122	0.00140	1.7E+5	1.713
40.0	0.00184	0.49089	0.00107	3.4E+5	1.714
45.0	0.00145	0.49066	0.000846	6.0E+5	1.714
50.0	0.00117	0.49050	0.000686	1.0E+6	1.714
55.0	0.000971	0.49037	0.000567	1.6E+6	1.714
60.0	0.000816	0.49028	0.000476	2.5E+6	1.714

Table -11.7. Rayleigh Flow  $k=1.4$  (continue)

M	$\frac{T}{T^*}$	$\frac{T_0}{T_0^*}$	$\frac{P}{P^*}$	$\frac{P_0}{P_0^*}$	$\frac{\rho^*}{\rho}$
65.0	0.000695	0.49021	0.000406	$3.8E+6$	1.714
70.0	0.000600	0.49015	0.000350	$5.5E+6$	1.714

The data is presented in Figure 11.39.

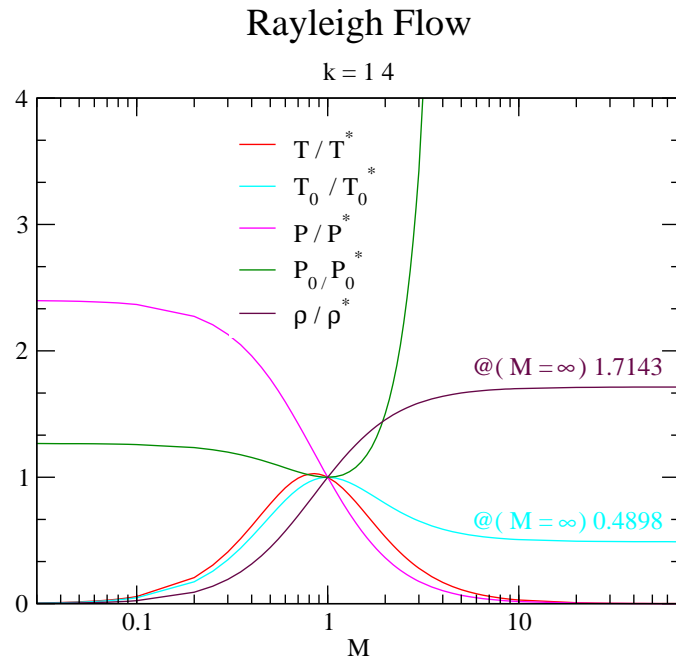

Fri May 6 11:11:44 2005

Fig. -11.39. The basic functions of Rayleigh Flow ( $k=1.4$ ).

### 11.10.3 Examples For Rayleigh Flow

The typical questions that are raised in Rayleigh Flow are related to the maximum heat that can be transferred to gas (reaction heat) and to the maximum flow rate.

**Example 11.23:**

Air enters a pipe with pressure of 3[bar] and temperature of 27°C at Mach number of  $M = 0.25$ . Due to internal combustion heat was released and the exit temperature was found to be 127°C. Calculate the exit Mach number, the exit pressure, the total exit pressure, and heat released and transferred to the air. At what amount of energy the exit temperature will start to decrease? Assume  $C_P = 1.004 \left[ \frac{kJ}{kg^\circ C} \right]$

SOLUTION

The entrance Mach number and the exit temperature are given and from Table (11.7) or from Potto–GDC the initial ratio can be calculated. From the initial values the ratio at the exit can be computed as the following.

M	$\frac{T}{T^*}$	$\frac{T_0}{T_0^*}$	$\frac{P}{P^*}$	$\frac{P_0}{P_0^*}$	$\frac{\rho^*}{\rho}$
0.25000	0.30440	0.25684	2.2069	1.2177	0.13793

and

$$\frac{T_2}{T^*} = \frac{T_1}{T^*} \frac{T_2}{T_1} = 0.304 \times \frac{400}{300} = 0.4053$$

M	$\frac{T}{T^*}$	$\frac{T_0}{T_0^*}$	$\frac{P}{P^*}$	$\frac{P_0}{P_0^*}$	$\frac{\rho^*}{\rho}$
0.29831	0.40530	0.34376	2.1341	1.1992	0.18991

The exit Mach number is known, the exit pressure can be calculated as

$$P_2 = P_1 \frac{P^*}{P_1} \frac{P_2}{P^*} = 3 \times \frac{1}{2.2069} \times 2.1341 = 2.901[\text{Bar}]$$

For the entrance, the stagnation values are

M	$\frac{T}{T_0}$	$\frac{\rho}{\rho_0}$	$\frac{A}{A^*}$	$\frac{P}{P_0}$	$\frac{A \times P}{A^* \times P_0}$	$\frac{F}{F^*}$
0.25000	0.98765	0.96942	2.4027	0.95745	2.3005	1.0424

The total exit pressure,  $P_{0_2}$  can be calculated as the following:

$$P_{0_2} = P_1 \overbrace{\frac{P_{0_1}}{P_1}}^{\text{isentropic}} \frac{P_0^*}{P_0^*} \frac{P_{0_2}}{P_0^*} = 3 \times \frac{1}{0.95745} \times \frac{1}{1.2177} \times 1.1992 = 3.08572[\text{Bar}]$$

The heat released (heat transferred) can be calculated from obtaining the stagnation temperature from both sides. The stagnation temperature at the entrance,  $T_{0_1}$

$$T_{0_1} = T_1 \overbrace{\frac{T_{0_1}}{T_1}}^{\text{isentropic}} = 300/0.98765 = 303.75[K]$$

The isentropic conditions at the exit are

M	$\frac{T}{T_0}$	$\frac{\rho}{\rho_0}$	$\frac{A}{A^*}$	$\frac{P}{P_0}$	$\frac{A \times P}{A^* \times P_0}$	$\frac{F}{F^*}$
0.29831	0.98251	0.95686	2.0454	0.94012	1.9229	0.90103

The exit stagnation temperature is

$$T_{0_2} = T_2 \overbrace{\frac{T_{0_2}}{T_2}}^{\text{isentropic}} = 400/0.98765 = 407.12[K]$$

The heat released becomes

$$\frac{Q}{\dot{m}} = C_p (T_{0_2} - T_{0_1}) = 1 \times 1.004 \times (407.12 - 303.75) = 103.78 \left[ \frac{kJ}{\text{sec} \cdot \text{kg}^\circ\text{C}} \right]$$

The maximum temperature occurs at the point where the Mach number reaches  $1/\sqrt{k}$  and at this point the Rayleigh relationship are:

M	$\frac{T}{T^*}$	$\frac{T_0}{T_0^*}$	$\frac{P}{P^*}$	$\frac{P_0}{P_0^*}$	$\frac{\rho^*}{\rho}$
0.84515	1.0286	0.97959	1.2000	1.0116	0.85714

The maximum heat before the temperature can be calculated as following:

$$T_{max} = T_1 \frac{T^*}{T_1} \frac{T_{max}}{T^*} \frac{300}{0.3044} \times 1.0286 = 1013.7[K]$$

The isentropic relationships at the maximum energy are

M	$\frac{T}{T_0}$	$\frac{\rho}{\rho_0}$	$\frac{A}{A^*}$	$\frac{P}{P_0}$	$\frac{A \times P}{A^* \times P_0}$	$\frac{F}{F^*}$
0.84515	0.87500	0.71618	1.0221	0.62666	0.64051	0.53376

The stagnation temperature for this point is

$$T_{0_{max}} = T_{max} * \frac{T_{0_{max}}}{T_{max}} = \frac{1013.7}{0.875} = 1158.51[K]$$

The maximum heat can be calculated as

$$\frac{Q}{\dot{m}} = C_p (T_{0_{max}} - T_{0_1}) = 1 \times 1.004 \times (1158.51 - 303.75) = 858.18 \left[ \frac{kJ}{\text{kg} \cdot \text{sec} \cdot \text{K}} \right]$$

Note that this point isn't the choking point. After this point additional heat results in temperature reduction.

**Example 11.24:**

Heat is added to the air until the flow is choked in amount of 600 [kJ/kg]. The exit temperature is 1000 [K]. Calculate the entrance temperature and the entrance Mach number.

SOLUTION

The solution involves finding the stagnation temperature at the exit and subtracting the heat (heat equation) to obtain the entrance stagnation temperature. From the Table (11.7) or from the Potto-GDC the following ratios can be obtained.

M	$\frac{T}{T_0}$	$\frac{\rho}{\rho_0}$	$\frac{A}{A^*}$	$\frac{P}{P_0}$	$\frac{A \times P}{A^* \times P_0}$	$\frac{F}{F^*}$
1.0000	0.833333	0.633394	1.0000	0.52828	0.52828	0.52828

The stagnation temperature

$$T_{0_2} = T_2 \frac{T_{0_2}}{T_2} = \frac{1000}{0.833333} = 1200.0[K]$$

The entrance temperature is

$$\frac{T_{0_1}}{T_{0_2}} = 1 - \frac{Q/\dot{m}}{T_{0_2} C_P} = 1200 - \frac{600}{1200 \times 1.004} \cong 0.5016$$

It must be noted that  $T_{0_2} = T_0^*$ . Therefore with  $\frac{T_{0_1}}{T_0^*} = 0.5016$  either by using Table (11.7) or by Potto-GDC the following is obtained

M	$\frac{T}{T^*}$	$\frac{T_0}{T_0^*}$	$\frac{P}{P^*}$	$\frac{P_0}{P_0^*}$	$\frac{\rho^*}{\rho}$
0.34398	0.50160	0.42789	2.0589	1.1805	0.24362

Thus, entrance Mach number is 0.38454 and the entrance temperature can be calculated as following

$$T_1 = T^* \frac{T_1}{T^*} = 1000 \times 0.58463 = 584.6[K]$$

---

End Solution

The difference between the supersonic branch to subsonic branch

**Example 11.25:**

Air with Mach 3 enters a frictionless duct with heating. What is the maximum heat that can be added so that there is no subsonic flow? If a shock occurs immediately at the entrance, what is the maximum heat that can be added?

SOLUTION

To achieve maximum heat transfer the exit Mach number has to be one,  $M_2 = 1$ .

$$\frac{Q}{\dot{m}} = C_p (T_{02} - T_{01}) = C_p T_0^* \left( 1 - \frac{T_{01}}{T_0^*} \right)$$

The table for  $M = 3$  as follows

M	$\frac{T}{T^*}$	$\frac{T_0}{T_0^*}$	$\frac{P}{P^*}$	$\frac{P_0}{P_0^*}$	$\frac{\rho^*}{\rho}$
3.0000	0.28028	0.65398	0.17647	3.4245	1.5882

The higher the entrance stagnation temperature the larger the heat amount that can be absorbed by the flow. In subsonic branch the Mach number after the shock is

$M_x$	$M_y$	$\frac{T_y}{T_x}$	$\frac{\rho_y}{\rho_x}$	$\frac{P_y}{P_x}$	$\frac{P_{0y}}{P_{0x}}$
3.0000	0.47519	2.6790	3.8571	10.3333	0.32834

With Mach number of  $M = 0.47519$  the maximum heat transfer requires information for Rayleigh flow as the following

M	$\frac{T}{T^*}$	$\frac{T_0}{T_0^*}$	$\frac{P}{P^*}$	$\frac{P_0}{P_0^*}$	$\frac{\rho^*}{\rho}$
0.33138	0.47519	0.40469	2.0802	1.1857	0.22844

M	$\frac{T}{T^*}$	$\frac{T_0}{T_0^*}$	$\frac{P}{P^*}$	$\frac{P_0}{P_0^*}$	$\frac{\rho^*}{\rho}$
0.47519	0.75086	0.65398	1.8235	1.1244	0.41176

It also must be noticed that stagnation temperature remains constant across shock wave.

$$\frac{\frac{Q}{\dot{m}}|_{subsonic}}{\frac{Q}{\dot{m}}|_{supersonic}} = \frac{\left(1 - \frac{T_{01}}{T_0^*}\right)_{subsonic}}{\left(1 - \frac{T_{01}}{T_0^*}\right)_{supersonic}} = \frac{1 - 0.65398}{1 - 0.65398} = 1$$

It is not surprising for the shock wave to be found in the Rayleigh flow.

---

End Solution

**Example 11.26:**

One of the reason that Rayleigh flow model was invented is to be analyzed the flow in a combustion chamber. Consider a flow of air in conduct with a fuel injected into the flow as shown in Figure 11.40. Calculate



11.10. INTRODUCTION

what the maximum fuel-air ratio. Calculate the exit condition for half the fuel-air ratio. Assume that the mixture properties are of air. Assume that the combustion heat is 25,000[KJ/kg fuel] for the average temperature range for this mixture. Neglect the fuel mass addition and assume that all the fuel is burned (neglect the complications of the increase of the entropy if accrue).

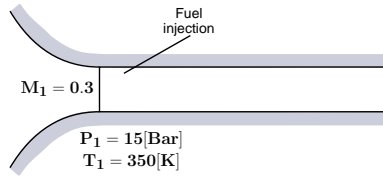

Fig. -11.40. Schematic of the combustion chamber.

SOLUTION

Under these assumptions, the maximum fuel air ratio is obtained when the flow is choked. The entranced condition can be obtained using Potto-GDC as following

M	$\frac{T}{T^*}$	$\frac{T_0}{T_0^*}$	$\frac{P}{P^*}$	$\frac{P_0}{P_0^*}$	$\frac{\rho^*}{\rho}$
0.30000	0.40887	0.34686	2.1314	1.1985	0.19183

The choking condition are obtained using also by Potto-GDC as

M	$\frac{T}{T^*}$	$\frac{T_0}{T_0^*}$	$\frac{P}{P^*}$	$\frac{P_0}{P_0^*}$	$\frac{\rho^*}{\rho}$
1.0000	1.0000	1.0000	1.0000	1.0000	1.0000

And the isentropic relationships for Mach 0.3 are

M	$\frac{T}{T_0}$	$\frac{\rho}{\rho_0}$	$\frac{A}{A^*}$	$\frac{P}{P_0}$	$\frac{A \times P}{A^* \times P_0}$	$\frac{F}{F^*}$
0.30000	0.98232	0.95638	2.0351	0.93947	1.9119	0.89699

The maximum fuel-air can be obtained by finding the heat per unit mass.

$$\frac{\dot{Q}}{\dot{m}} = \frac{Q}{m} = C_p (T_{02} - T_{01}) = C_p T_1 \left( 1 - \frac{T_{01}}{T^*} \right)$$

$$\frac{\dot{Q}}{\dot{m}} = 1.04 \times 350 / 0.98232 \times (1 - 0.34686) \sim 242.022 [kJ/kg]$$

The fuel-air mass ratio has to be

$$\frac{m_{fuel}}{m_{air}} = \frac{\text{needed heat}}{\text{combustion heat}} = \frac{242.022}{25,000} \sim 0.0097 [kg \text{ fuel} / kg \text{ air}]$$

If only half of the fuel is supplied then the exit temperature is

$$T_{02} = \frac{Q}{mC_p} + T_{01} = \frac{0.5 \times 242.022}{1.04} + 350/0.98232 \sim 472.656[K]$$

The exit Mach number can be determined from the exit stagnation temperature as following:

$$\frac{T_2}{T^*} = \frac{T_{01}}{T_0^*} \frac{T_{02}}{T_{01}}$$

The last temperature ratio can be calculated from the value of the temperatures

$$\frac{T_2}{T^*} = 0.34686 \times \frac{472.656}{350/0.98232} \sim 0.47685$$

The Mach number can be obtained from a Rayleigh table or using Potto-GDC

M	$\frac{T}{T^*}$	$\frac{T_0}{T_0^*}$	$\frac{P}{P^*}$	$\frac{P_0}{P_0^*}$	$\frac{\rho^*}{\rho}$
0.33217	0.47685	0.40614	2.0789	1.1854	0.22938

It should be noted that this example is only to demonstrate how to carry the calculations.

---

---

# CHAPTER 12

---

---

## Compressible Flow 2-Dimensional

### 12.1 Introduction

In Chapter 11 the discussed dealt with one-dimensional and semi one-dimensional flow. In this Chapter the focus is around the two dimensional effect which focus around the oblique shock and Prandtl-Meyer flow (in other word it focus around Theodor Meyer's thesis). This Chapter present a simplified summary of two chapters from the book "Fundamentals of Compressible Flow" by this author.

#### 12.1.1 Preface to Oblique Shock

In Section (11.5), a discussion on a normal shock was presented. A normal shock is a special type of shock wave. Another type of shock wave is the oblique shock. In the literature oblique shock, normal shock, and Prandtl-Meyer function are presented as three separate and different issues. However, one can view all these cases as three different regions of a flow over a plate with a deflection section.

Clearly, variation of the deflection angle from a zero ( $\delta = 0$ ) to a positive value results in oblique shock (see Figure 12.1). Further changing the deflection angle to a negative value results in expansion waves. The common representation is done by ignoring the boundaries of these models. However, this section attempts to show the boundaries and the limits or connections of these models.

A normal shock occurs when there is a disturbance downstream which imposes

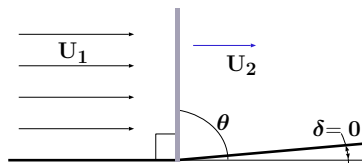

Fig. -12.1. A view of a straight normal shock as a limited case for oblique shock.

a boundary condition on the flow in which the fluid/gas can react only by a sharp change in the flow direction. As it may be recalled, normal shock occurs when a wall is straight/flat ( $\delta = 0$ ) as shown in Figure 12.1 due to disturbance. When the deflection angle is increased, the gas flow must match the boundary conditions. This matching can occur only when there is a discontinuity in the flow field. Thus, the direction of the flow is changed by a shock with an angle to the flow. This shock is commonly referred to as the oblique shock.

Decreasing the deflection angle also requires the boundary conditions to match the geometry. Yet, for a negative deflection angle (in this section's notation), the flow must be continuous. The analysis shows that the flow velocity must increase to achieve this requirement. This velocity increase is referred to as the expansion wave. As it will be shown in the next section, as opposed to oblique shock analysis, the increase in the upstream Mach number determines the downstream Mach number and the "negative" deflection angle.

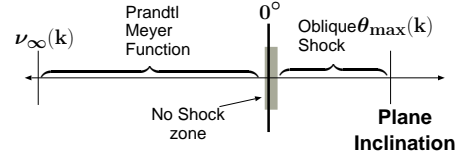

Fig. -12.2. The regions where oblique shock or Prandtl-Meyer function exist. Notice that both have a maximum point and a "no solution" zone, which is around zero. However, Prandtl-Meyer function approaches closer to a zero deflection angle.

It has to be pointed out that both the oblique shock and the Prandtl-Meyer function have a maximum point for  $M_1 \rightarrow \infty$ . However, the maximum point for the Prandtl-Meyer function is much larger than the oblique shock by a factor of more than 2. What accounts for the larger maximum point is the effective turning (less entropy production) which will be explained in the next chapter (see Figure (12.2)).

12.1.1.1 Introduction to Zero Inclination

What happens when the inclination angle is zero? Which model is correct to use? Can these two conflicting models, the oblique shock and the Prandtl-Meyer function, co-exist? Or perhaps a different model better describes the physics. In some books and in the famous NACA report 1135 it was assumed that Mach wave and oblique shock co-occur in the same zone. Previously (see Chapter ??), it was assumed that normal shock occurs at the same time. In this chapter, the stability issue will be examined in greater detail.

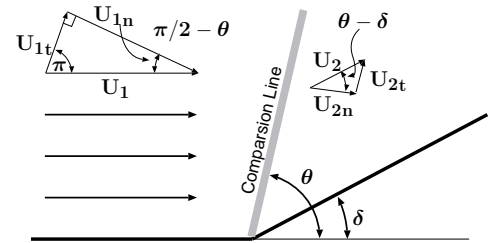

Fig. -12.3. A typical oblique shock schematic.

## 12.2 Oblique Shock

The shock occurs in reality in situations where the shock has three-dimensional effects. The three-dimensional effects of the shock make it appear as a curved plane. However, one-dimensional shock can be considered a representation for a chosen arbitrary accuracy with a specific small area. In such a case, the change of the orientation makes the shock considerations two-dimensional. Alternately, using an infinite (or a two-dimensional) object produces a two-dimensional shock. The two-dimensional effects occur when the flow is affected from the "side," i.e., the change is in the flow direction. An example of such case is creation of shock from the side by deflection shown in Figure 12.3.

To match the boundary conditions, the flow turns after the shock to be parallel to the inclination angle schematically shown in Figure (12.3). The deflection angle,  $\delta$ , is the direction of the flow after the shock (parallel to the wall). The normal shock analysis dictates that after the shock, the flow is always subsonic. The total flow after the oblique shock can also be supersonic, which depends on the boundary layer and the deflection angle.

The velocity has two components (with respect to the shock plane/surface). Only the oblique shock's normal component undergoes the "shock." The tangent component does not change because it does not "move" across the shock line. Hence, the mass balance reads

$$\rho_1 U_{1n} = \rho_2 U_{2n} \quad (12.1)$$

The momentum equation reads

$$P_1 + \rho_1 U_{1n}^2 = P_2 + \rho_2 U_{2n}^2 \quad (12.2)$$

The momentum equation in the tangential direction is reduced to

$$U_{1t} = U_{2t} \quad (12.3)$$

The energy balance in coordinates moving with shock reads

$$C_p T_1 + \frac{U_{1n}^2}{2} = C_p T_2 + \frac{U_{2n}^2}{2} \quad (12.4)$$

Equations (12.1), (12.2), and (12.4) are the same as the equations for normal shock with the exception that the total velocity is replaced by the perpendicular components. Yet, the new relationship between the upstream Mach number, the deflection angle,  $\delta$ , and the Mach angle,  $\theta$  has to be solved. From the geometry it can be observed that

$$\tan \theta = \frac{U_{1n}}{U_{1t}} \quad (12.5)$$

and

$$\tan(\theta - \delta) = \frac{U_{2n}}{U_{2t}} \quad (12.6)$$

Unlike in the normal shock, here there are three possible pairs<sup>1</sup> of solutions to these equations. The first is referred to as the weak shock; the second is the strong shock; and the third is an impossible solution (thermodynamically)<sup>2</sup>. Experiments and experience have shown that the common solution is the weak shock, in which the shock turns to a lesser extent<sup>3</sup>.

$$\frac{\tan \theta}{\tan(\theta - \delta)} = \frac{U_{1n}}{U_{2n}} \quad (12.7)$$

The above velocity–geometry equations can also be expressed in term of Mach number, as

$$\sin \theta = \frac{M_{1n}}{M_1} \quad (12.8)$$

and in the downstream side reads

$$\sin(\theta - \delta) = \frac{M_{2n}}{M_2} \quad (12.9)$$

Equation (12.8) alternatively also can be expressed as

$$\cos \theta = \frac{M_{1t}}{M_1} \quad (12.10)$$

And equation (12.9) alternatively also can be expressed as

$$\cos(\theta - \delta) = \frac{M_{2t}}{M_2} \quad (12.11)$$

The total energy across a stationary oblique shock wave is constant, and it follows that the **total** speed of sound is constant across the (oblique) shock. It should be noted that although,  $U_{1t} = U_{2t}$  the Mach number is  $M_{1t} \neq M_{2t}$  because the temperatures on both sides of the shock are different,  $T_1 \neq T_2$ .

As opposed to the normal shock, here angles (the second dimension) have to be determined. The solution from this set of four equations, (12.8) through (12.11), is a function of four unknowns of  $M_1$ ,  $M_2$ ,  $\theta$ , and  $\delta$ . Rearranging this set utilizing geometrical identities such as  $\sin \alpha = 2 \sin \alpha \cos \alpha$  results in

**Angle Relationship**

$$\tan \delta = 2 \cot \theta \left[ \frac{M_1^2 \sin^2 \theta - 1}{M_1^2 (k + \cos 2\theta) + 2} \right] \quad (12.12)$$

<sup>1</sup>This issue is due to R. Menikoff, who raised the solution completeness issue.

<sup>2</sup>The solution requires solving the entropy conservation equation. The author is not aware of “simple” proof and a call to find a simple proof is needed.

<sup>3</sup>Actually this term is used from historical reasons. The lesser extent angle is the unstable angle and the weak angle is the middle solution. But because the literature referred to only two roots, the term lesser extent is used.

The relationship between the properties can be determined by substituting  $M_1 \sin \theta$  for of  $M_1$  into the normal shock relationship, which results in

$$\boxed{\text{Pressure Ratio}} \quad \frac{P_2}{P_1} = \frac{2k M_1^2 \sin^2 \theta - (k-1)}{k+1} \quad (12.13)$$

The density and normal velocity ratio can be determined by the following equation

$$\boxed{\text{Density Ratio}} \quad \frac{\rho_2}{\rho_1} = \frac{U_{1n}}{U_{2n}} = \frac{(k+1)M_1^2 \sin^2 \theta}{(k-1)M_1^2 \sin^2 \theta + 2} \quad (12.14)$$

The temperature ratio is expressed as

$$\boxed{\text{Temperature Ratio}} \quad \frac{T_2}{T_1} = \frac{2k M_1^2 \sin^2 \theta - (k-1) [(k-1)M_1^2 + 2]}{(k+1)^2 M_1} \quad (12.15)$$

Prandtl's relation for oblique shock is

$$U_{n1} U_{n2} = c^2 - \frac{k-1}{k+1} U_t^2 \quad (12.16)$$

The Rankine–Hugoniot relations are the same as the relationship for the normal shock

$$\frac{P_2 - P_1}{\rho_2 - \rho_1} = k \frac{P_2 - P_1}{\rho_2 - \rho_1} \quad (12.17)$$

### 12.2.1 Solution of Mach Angle

Oblique shock, if orientated to a coordinate perpendicular and parallel shock plane is like a normal shock. Thus, the relationship between the properties can be determined by using the normal components or by utilizing the normal shock table developed earlier. One has to be careful to use the normal components of the Mach numbers. The stagnation temperature contains the total velocity.

Again, the normal shock is a one-dimensional problem, thus, only one parameter is required (to solve the problem). Oblique shock is a two-dimensional problem and two properties must be provided so a solution can be found. Probably, the most useful properties are upstream Mach number,  $M_1$  and the deflection angle, which create a somewhat complicated mathematical procedure, and this will be discussed later. Other combinations of properties provide a relatively simple mathematical treatment, and the solutions of selected pairs and selected relationships will be presented.

**12.2.1.1 Upstream Mach Number,  $M_1$ , and Deflection Angle,  $\delta$** 

Again, this set of parameters is, perhaps, the most common and natural to examine. Thompson (1950) has shown that the relationship of the shock angle is obtained from the following cubic equation:

Governing Angle Equation

$$x^3 + a_1x^2 + a_2x + a_3 = 0 \quad (12.18)$$

where

$$x = \sin^2 \theta \quad (12.19)$$

and

$$a_1 = -\frac{M_1^2 + 2}{M_1^2} - k \sin^2 \delta \quad (12.20)$$

$$a_2 = -\frac{2M_1^2 + 1}{M_1^4} + \left[ \frac{(k+1)^2}{4} + \frac{k-1}{M_1^2} \right] \sin^2 \delta \quad (12.21)$$

$$a_3 = -\frac{\cos^2 \delta}{M_1^4} \quad (12.22)$$

Equation (12.18) requires that  $x$  has to be a real and positive number to obtain a real deflection angle<sup>4</sup>. Clearly,  $\sin \theta$  must be positive, and the negative sign refers to the mirror image of the solution. Thus, the negative root of  $\sin \theta$  must be disregarded

The solution of a cubic equation such as (12.18) provides three roots<sup>5</sup>. These roots can be expressed as

First Root

$$x_1 = -\frac{1}{3}a_1 + (S + T) \quad (12.23)$$

Second Root

$$x_2 = -\frac{1}{3}a_1 - \frac{1}{2}(S + T) + \frac{1}{2}i\sqrt{3}(S - T) \quad (12.24)$$

and

Third Root

$$x_3 = -\frac{1}{3}a_1 - \frac{1}{2}(S + T) - \frac{1}{2}i\sqrt{3}(S - T) \quad (12.25)$$

<sup>4</sup> This point was pointed out by R. Menikoff. He also suggested that  $\theta$  is bounded by  $\sin^{-1} 1/M_1$  and 1.

<sup>5</sup>The highest power of the equation (only with integer numbers) is the number of the roots. For example, in a quadratic equation there are two roots.



Where

$$S = \sqrt[3]{R + \sqrt{D}}, \quad (12.26)$$

$$T = \sqrt[3]{R - \sqrt{D}} \quad (12.27)$$

and where the definition of the  $D$  is

$$D = Q^3 + R^2 \quad (12.28)$$

and where the definitions of  $Q$  and  $R$  are

$$Q = \frac{3a_2 - a_1^2}{9} \quad (12.29)$$

and

$$R = \frac{9a_1a_2 - 27a_3 - 2a_1^3}{54} \quad (12.30)$$

Only three roots can exist for the Mach angle,  $\theta$ . From a mathematical point of view, if  $D > 0$ , one root is real and two roots are complex. For the case  $D = 0$ , all the roots are real and at least two are identical. In the last case where  $D < 0$ , all the roots are real and unequal.

The physical meaning of the above analysis demonstrates that in the range where  $D > 0$  no solution can exist because no imaginary solution can exist<sup>6</sup>.  $D > 0$  occurs when no shock angle can be found, so that the shock normal component is reduced to subsonic and yet parallel to the inclination angle.

Furthermore, only in some cases when  $D = 0$  does the solution have a physical meaning. Hence, the solution in the case of  $D = 0$  has to be examined in the light of other issues to determine the validity of the solution.

When  $D < 0$ , the three unique roots are reduced to two roots at least for the steady state because thermodynamics dictates<sup>7</sup> that. Physically, it can be shown that the first solution(12.23), referred sometimes as a thermodynamically unstable root, which is also related to a decrease in entropy, is "unrealistic." Therefore, the first solution does not occur in reality, at least, in steady-state situations. This root has only a mathematical meaning for steady-state analysis<sup>8</sup>.

<sup>6</sup>A call for suggestions, to explain about complex numbers and imaginary numbers should be included. Maybe insert an example where imaginary solution results in no physical solution.

<sup>7</sup>This situation is somewhat similar to a cubical body rotation. The cubical body has three symmetrical axes which the body can rotate around. However, the body will freely rotate only around two axes with small and large moments of inertia. The body rotation is unstable around the middle axes. The reader can simply try it.

<sup>8</sup>There is no experimental or analytical evidence, that the author has found, showing that it is totally impossible. The "unstable" terms can be thermodynamically stable in unsteady case. Though, those who are dealing with rapid transient situations should be aware that this angle of oblique shock can exist. There is no theoretical evidence that showing that in strong unsteady state this angle is unstable. The shock will initially for a very brief time transient in it and will jump from this angle to the thermodynamically stable angles.

These two roots represent two different situations. First, for the second root, the shock wave keeps the flow almost all the time as a supersonic flow and it is referred to as the weak solution (there is a small section that the flow is subsonic). Second, the third root always turns the flow into subsonic and it is referred to as the strong solution. It should be noted that this case is where entropy increases in the largest amount.

In summary, if an imaginary hand moves the shock angle starting from the deflection angle and reaching the first angle that satisfies the boundary condition, this situation is unstable and the shock angle will jump to the second angle (root). If an additional “push” is given, for example, by additional boundary conditions, the shock angle will jump to the third root<sup>9</sup>. These two angles of the strong and weak shock are stable for a two-dimensional wedge (see the appendix of this chapter for a limited discussion on the stability<sup>10</sup>).

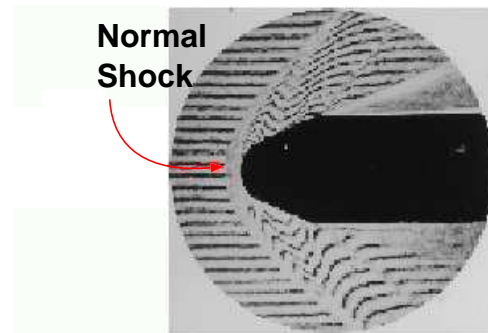

Fig. -12.4. Flow around spherically blunted 30° cone-cylinder with Mach number 2.0. It can be noticed that the normal shock, the strong shock, and the weak shock coexist.

## 12.2.2 When No Oblique Shock Exist or the case of $D > 0$

### 12.2.2.1 Large deflection angle for given, $M_1$

The first range is when the deflection angle reaches above the maximum point. For a given upstream Mach number,  $M_1$ , a change in the inclination angle requires a larger energy to change the flow direction. Once, the inclination angle reaches the “maximum potential energy,” a change in the flow direction is no longer possible. As the alternative view, the fluid “sees” the disturbance (in this case, the wedge) in front of it and hence the normal shock occurs. Only when the fluid is away from the object (smaller angle) fluid “sees” the object in a different inclination angle. This different inclination angle is sometimes referred to as an imaginary angle.

#### The Simple Calculation Procedure

For example, in Figure (12.4) and (12.5), the imaginary angle is shown. The flow is far away from the object and does not “see” the object. For example, for,  $M_1 \rightarrow \infty$  the maximum deflection angle is calculated when  $D = Q^3 + R^2 = 0$ . This can be done

<sup>9</sup>See the discussion on the stability. There are those who view this question not as a stability equation but rather as under what conditions a strong or a weak shock will prevail.

<sup>10</sup>This material is extra and not recommended for standard undergraduate students.

by evaluating the terms  $a_1$ ,  $a_2$ , and  $a_3$  for  $M_1 = \infty$ .

$$a_1 = -1 - k \sin^2 \delta$$

$$a_2 = \frac{(k + 1)^2 \sin^2 \delta}{4}$$

$$a_3 = 0$$

With these values the coefficients  $R$  and  $Q$  are

$$R = \frac{-9(1 + k \sin^2 \delta) \left( \frac{(k + 1)^2 \sin^2 \delta}{4} \right) - (2)(-)(1 + k \sin^2 \delta)^2}{54}$$

and

$$Q = \frac{(1 + k \sin^2 \delta)^2}{9}$$

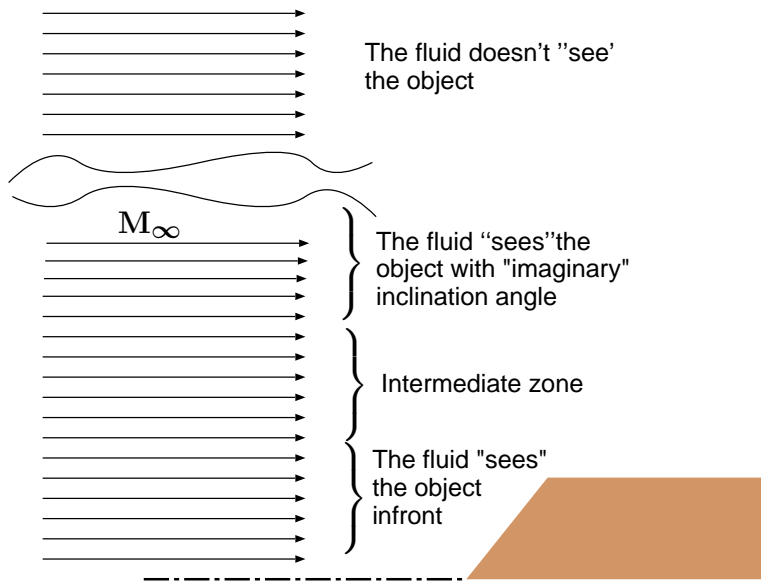

Fig. -12.5. The view of a large inclination angle from different points in the fluid field.

Solving equation (12.28) after substituting these values of  $Q$  and  $R$  provides series of roots from which only one root is possible. This root, in the case  $k = 1.4$ , is just above  $\delta_{max} \sim \frac{\pi}{4}$  (note that the maximum is also a function of the heat ratio,  $k$ ).

While the above procedure provides the general solution for the three roots, there is a simplified transformation that provides solution for the strong and weak solution. It must be noted that in doing this transformation, the first solution is “lost” supposedly because it is “negative.” In reality the first solution is not negative but rather some value between zero and the weak angle. Several researchers<sup>11</sup> suggested that instead Thompson’s equation should be expressed by equation (12.18) by  $\tan \theta$  and is transformed into

$$\left(1 + \frac{k-1}{2} M_1^2\right) \tan \delta \tan^3 \theta - (M_1^2 - 1) \tan^2 \theta + \left(1 + \frac{k+1}{2} M_1^2\right) \tan \delta \tan \theta + 1 = 0 \quad (12.31)$$

The solution to this equation (12.31) for the weak angle is

**Weak Angle Solution**

$$\theta_{weak} = \tan^{-1} \left( \frac{M_1^2 - 1 + 2 f_1(M_1, \delta) \cos \left( \frac{4\pi + \cos^{-1}(f_2(M_1, \delta))}{3} \right)}{3 \left(1 + \frac{k-1}{2} M_1^2\right) \tan \delta} \right)$$

(12.32)

**Strong Angle Solution**

$$\theta_{strong} = \tan^{-1} \frac{M_1^2 - 1 + 2 f_1(M_1, \delta) \cos \left( \frac{\cos^{-1}(f_2(M_1, \delta))}{3} \right)}{3 \left(1 + \frac{k-1}{2} M_1^2\right) \tan \delta}$$

(12.33)

where these additional functions are

$$f_1(M_1, \delta) = \sqrt{(M_1^2 - 1)^2 - 3 \left(1 + \frac{k-1}{2} M_1^2\right) \left(1 + \frac{k+1}{2} M_1^2\right) \tan^2 \delta} \quad (12.34)$$

and

$$f_2(M_1, \delta) = \frac{(M_1^2 - 1)^3 - 9 \left(1 + \frac{k-1}{2} M_1^2\right) \left(1 + \frac{k-1}{2} M_1^2 + \frac{k+1}{4} M_1^4\right) \tan^2 \delta}{f_1(M_1, \delta)^3} \quad (12.35)$$

<sup>11</sup>A whole discussion on the history of this can be found in “Open content approach to academic writing” on <http://www.potto.org/obliqueArticle.phpattheendofthebook>.

Figure (12.6) exhibits typical results for oblique shock for two deflection angle of 5 and 25 degree. Generally, the strong shock is reduced as the increase of the Mach number while the weak shock is increase. The impossible shock for unsteady state is almost linear function of the upstream Mach number and almost not affected by the deflection angle.

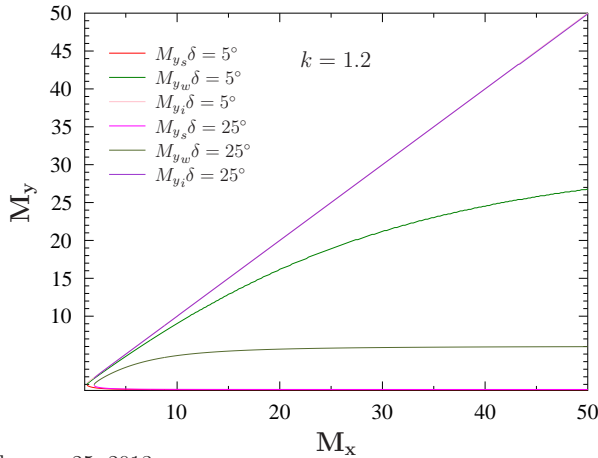

February 25, 2013

Fig. -12.6. The three different Mach numbers after the oblique shock for two deflection angles of 5° and 25°.

### The Procedure for Calculating The Maximum Deflection Point

The maximum angle is obtained when  $D = 0$ . When the right terms defined in (12.20)-(12.21), (12.29), and (12.30) are substituted into this equation and utilizing the trigonometrical identity  $\sin^2 \delta + \cos^2 \delta = 1$  and other trigonometrical identities results in Maximum Deflection Mach Number's equation in which is

$$M_1^2 (k + 1) (M_{1n}^2 + 1) = 2(kM_{1n}^4 + 2M_{1n}^2 - 1) \tag{12.36}$$

This equation and its twin equation can be obtained by an alternative procedure proposed by someone<sup>12</sup> who suggested another way to approach this issue. It can be noticed that in equation (12.12), the deflection angle is a function of the Mach angle and the upstream Mach number,  $M_1$ . Thus, one can conclude that the maximum Mach angle is only a function of the upstream Mach number,  $M_1$ . This can be shown mathematically by the argument that differentiating equation (12.12) and equating the

<sup>12</sup>At first, it was seen as C. J.Chapman, English mathematician to be the creator but later an earlier version by several months was proposed by Bernard Grossman. At this stage, it is not clear who was the first to propose it.

results to zero creates relationship between the Mach number,  $M_1$  and the maximum Mach angle,  $\theta$ . Since in that equation there appears only the heat ratio  $k$ , and Mach number,  $M_1$ ,  $\theta_{max}$  is a function of only these parameters. The differentiation of the equation (12.12) yields

$$\frac{d \tan \delta}{d\theta} = \frac{kM_1^4 \sin^4 \theta + \left(2 - \frac{(k+1)}{2} M_1^2\right) M_1^2 \sin^2 \theta - \left(1 + \frac{(k+1)}{2} M_1^2\right)}{kM_1^4 \sin^4 \theta - \left[(k-1) + \frac{(k+1)^2 M_1^2}{4}\right] M_1^2 \sin^2 \theta - 1} \quad (12.37)$$

Because  $\tan$  is a monotonous function, the maximum appears when  $\theta$  has its maximum. The numerator of equation (12.37) is zero at different values of the denominator. Thus, it is sufficient to equate the numerator to zero to obtain the maximum. The nominator produces a quadratic equation for  $\sin^2 \theta$  and only the positive value for  $\sin^2 \theta$  is applied here. Thus, the  $\sin^2 \theta$  is

$$\sin^2 \theta_{max} = \frac{-1 + \frac{k+1}{4} M_1^2 + \sqrt{(k+1) \left[1 + \frac{k-1}{2} M_1^2 + \left(\frac{k+1}{2} M_1\right)^4\right]}}{kM_1^2} \quad (12.38)$$

Equation (12.38) should be referred to as the maximum's equation. It should be noted that both the Maximum Mach Deflection equation and the maximum's equation lead to the same conclusion that the maximum  $M_{1n}$  is only a function of upstream the Mach number and the heat ratio  $k$ . It can be noticed that the Maximum Deflection Mach Number's equation is also a quadratic equation for  $M_{1n}^2$ . Once  $M_{1n}$  is found, then the Mach angle can be easily calculated by equation (12.8). To compare these two equations the simple case of Maximum for an infinite Mach number is examined. It must be pointed out that similar procedures can also be proposed (even though it does not appear in the literature). Instead, taking the derivative with respect to  $\theta$ , a derivative can be taken with respect to  $M_1$ . Thus,

$$\frac{d \tan \delta}{dM_1} = 0 \quad (12.39)$$

and then solving equation (12.39) provides a solution for  $M_{max}$ .

A simplified case of the Maximum Deflection Mach Number's equation for large Mach number becomes

$$M_{1n} = \sqrt{\frac{k+1}{2k}} M_1 \quad \text{for } M_1 \gg 1 \quad (12.40)$$

Hence, for large Mach numbers, the Mach angle is  $\sin \theta = \sqrt{\frac{k+1}{2k}}$  (for  $k=1.4$ ), which makes  $\theta = 1.18$  or  $\theta = 67.79^\circ$ .

With the value of  $\theta$  utilizing equation (12.12), the maximum deflection angle can be computed. Note that this procedure does not require an approximation of  $M_{1n}$  to

be made. The general solution of equation (12.36) is

Normal Shock Minikoff Solution

$$M_{1n} = \frac{\sqrt{\sqrt{(k+1)^2 M_1^4 + 8(k^2-1)M_1^2 + 16(k+1)} + (k+1)M_1^2 - 4}}{2\sqrt{k}}$$

(12.41)

Note that Maximum Deflection Mach Number's equation can be extended to deal with more complicated equations of state (aside from the perfect gas model).

This typical example is for those who like mathematics.

**Example 12.1:**

*Derive the perturbation of Maximum Deflection Mach Number's equation for the case of a very small upstream Mach number number of the form  $M_1 = 1 + \epsilon$ . Hint, Start with equation (12.36) and neglect all the terms that are relatively small.*

SOLUTION

The solution can be done by substituting ( $M_1 = 1 + \epsilon$ ) into equation (12.36) and it results in

Normal Shock Small Values

$$M_{1n} = \sqrt{\frac{\sqrt{\epsilon(k)} + \epsilon^2 + 2\epsilon - 3 + k\epsilon^2 + 2k\epsilon + k}{4k}}$$

(12.42)

where the epsilon function is

$$\begin{aligned} \epsilon(k) = & (k^2 + 2k + 1)\epsilon^4 + (4k^2 + 8k + 4)\epsilon^3 + \\ & (14k^2 + 12k - 2)\epsilon^2 + (20k^2 + 8k - 12)\epsilon + 9(k+1)^2 \end{aligned} \quad (12.43)$$

Now neglecting all the terms with  $\epsilon$  results for the epsilon function in

$$\epsilon(k) \sim 9(k+1)^2 \quad (12.44)$$

And the total operation results in

$$M_{1n} = \sqrt{\frac{3(k+1) - 3 + k}{4k}} = 1 \quad (12.45)$$

Interesting to point out that as a consequence of this assumption the maximum shock angle,  $\theta$  is a normal shock. However, taking the second term results in different value. Taking the second term in the explanation results in

$$M_{1n} = \sqrt{\frac{\sqrt{9(k+1)^2 + (20k^2 + 8k - 12)\epsilon - 3 + k} + 2(1+k)\epsilon}{4k}} \quad (12.46)$$

Note this equation (12.46) produce an un realistic value and additional terms are required to obtained to produce a realistic value.

---

End Solution

---

### 12.2.2.2 The case of $D \geq 0$ or $0 \geq \delta$

The second range in which  $D > 0$  is when  $\delta < 0$ . Thus, first the transition line in which  $D = 0$  has to be determined. This can be achieved by the standard mathematical procedure of equating  $D = 0$ . The analysis shows regardless of the value of the upstream Mach number  $D = 0$  when  $\delta = 0$ . This can be partially demonstrated by evaluating the terms  $a_1$ ,  $a_2$ , and  $a_3$  for the specific value of  $M_1$  as following

$$\begin{aligned} a_1 &= \frac{M_1^2 + 2}{M_1^2} \\ a_2 &= -\frac{2M_1^2 + 1}{M_1^4} \\ a_3 &= -\frac{1}{M_1^4} \end{aligned} \quad (12.47)$$

With values presented in equations (12.47) for  $R$  and  $Q$  becoming

$$\begin{aligned} R &= \frac{9 \left( \frac{M_1^2 + 2}{M_1^2} \right) \left( \frac{2M_1^2 + 1}{M_1^4} \right) + 27 \left( \frac{1}{M_1^4} \right) - 2 \left( \frac{M_1^2 + 2}{M_1^2} \right)^2}{54} \\ &= \frac{9(M_1^2 + 2)(2M_1^2 + 1) + 27M_1^2 - 2M_1^2(M_1^2 + 2)^2}{54M_1^6} \end{aligned} \quad (12.48)$$

and

$$Q = \frac{3 \left( \frac{2M_1^2 + 1}{M_1^4} \right) - \left( \frac{M_1^2 + 2}{M_1^2} \right)^3}{9} \quad (12.49)$$

Substituting the values of  $Q$  and  $R$  equations (12.48) (12.49) into equation (12.28) provides the equation to be solved for  $\delta$ .

$$\begin{aligned} &\left[ \frac{3 \left( \frac{2M_1^2 + 1}{M_1^4} \right) - \left( \frac{M_1^2 + 2}{M_1^2} \right)^3}{9} \right]^3 + \\ &\left[ \frac{9(M_1^2 + 2)(2M_1^2 + 1) + 27M_1^2 - 2M_1^2(M_1^2 + 2)^2}{54M_1^6} \right]^2 = 0 \end{aligned} \quad (12.50)$$

The author is not aware of any analytical demonstration in the literature which shows that the solution is identical to zero for  $\delta = 0^{13}$ . Nevertheless, this identity can be

<sup>13</sup>A mathematical challenge for those who like to work it out.



demonstrated by checking several points for example,  $M_1 = 1., 2.0, \infty$  and additional discussion and proofs can be found in "Fundamentals of Compressible Flow" by this author.

In the range where  $\delta \leq 0$ , the question is whether it is possible for an oblique shock to exist? The answer according to this analysis and stability analysis is no. Suppose that there is a Mach wave at the wall at zero inclination (see Figure (12.7)). Obviously, another Mach wave occurs after a small distance. But because the velocity after a Mach wave (even for an extremely weak shock wave) is reduced, thus, the Mach angle will be larger ( $\mu_2 > \mu_1$ ). If the situation

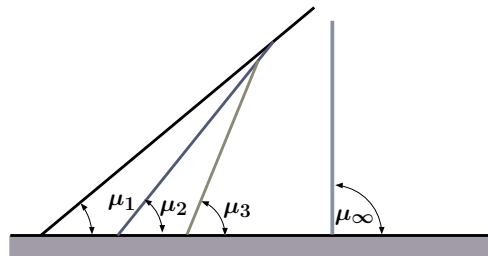

Fig. -12.7. The Mach waves that are supposed to be generated at zero inclination.

keeps on occurring over a finite distance, there will be a point where the Mach number will be 1 and a normal shock will occur, according to the common explanation. However, the reality is that no continuous Mach wave can occur because of the viscosity (boundary layer). In reality, there are imperfections in the wall and in the flow and there is the question of boundary layer. It is well known, in the engineering world, that there is no such thing as a perfect wall. The imperfections of the wall can be, for simplicity's sake, assumed to be as a sinusoidal shape. For such a wall the zero inclination changes from small positive value to a negative value. If the Mach number is large enough and the wall is rough enough, there will be points where a weak<sup>14</sup> weak will be created. On the other hand, the boundary layer covers or smooths out the bumps. With these conflicting mechanisms, both will not allow a situation of zero inclination with emission of Mach wave. At the very extreme case, only in several points (depending on the bumps) at the leading edge can a very weak shock occur. Therefore, for the purpose of an introductory class, no Mach wave at zero inclination should be assumed.

Furthermore, if it was assumed that no boundary layer exists and the wall is perfect, any deviations from the zero inclination angle creates a jump from a positive angle (Mach wave) to a negative angle (expansion wave). This theoretical jump occurs because in a Mach wave the velocity decreases while in the expansion wave the velocity increases. Furthermore, the increase and the decrease depend on the upstream Mach number but in different directions. This jump has to be in reality either smoothed out or has a physical meaning of jump (for example, detach normal shock). The analysis started by looking at a normal shock which occurs when there is a zero inclination. After analysis of the oblique shock, the same conclusion must be reached, i.e. that the normal shock can occur at zero inclination. The analysis of the oblique shock suggests that the inclination angle is not the source (boundary condition) that creates the shock. There must be another boundary condition(s) that causes the normal shock. In the light of this discussion, at least for a simple engineering analysis, the zone in the proximity

<sup>14</sup>It is not a mistake, there are two "weaks." These words mean two different things. The first "weak" means more of compression "line" while the other means the weak shock.

of zero inclination (small positive and negative inclination angle) should be viewed as a zone without any change unless the boundary conditions cause a normal shock. Nevertheless, emission of Mach wave can occur in other situations. The approximation of weak wave with nonzero strength has engineering applicability in a very limited cases, especially in acoustic engineering, but for most cases it should be ignored.

### 12.2.2.3 Upstream Mach Number, $M_1$ , and Shock Angle, $\theta$

The solution for upstream Mach number,  $M_1$ , and shock angle,  $\theta$ , are far much simpler and a unique solution exists. The deflection angle can be expressed as a function of these variables as

$$\cot \delta = \tan(\theta) \left[ \frac{(k+1) M_1^2}{2(M_1^2 \sin^2 \theta - 1)} - 1 \right] \quad (12.51)$$

or

$$\tan \delta = \frac{2 \cot \theta (M_1^2 \sin^2 \theta - 1)}{2 + M_1^2 (k + 1 - 2 \sin^2 \theta)} \quad (12.52)$$

The pressure ratio can be expressed as

$$\frac{P_2}{P_1} = \frac{2k M_1^2 \sin^2 \theta - (k-1)}{k+1} \quad (12.53)$$

The density ratio can be expressed as

$$\frac{\rho_2}{\rho_1} = \frac{U_{1n}}{U_{2n}} = \frac{(k+1) M_1^2 \sin^2 \theta}{(k-1) M_1^2 \sin^2 \theta + 2} \quad (12.54)$$

The temperature ratio expressed as

$$\frac{T_2}{T_1} = \frac{c_2^2}{c_1^2} = \frac{(2k M_1^2 \sin^2 \theta - (k-1)) ((k-1) M_1^2 \sin^2 \theta + 2)}{(k+1) M_1^2 \sin^2 \theta} \quad (12.55)$$

The Mach number after the shock is

$$M_2^2 \sin(\theta - \delta) = \frac{(k-1) M_1^2 \sin^2 \theta + 2}{2k M_1^2 \sin^2 \theta - (k-1)} \quad (12.56)$$

or explicitly

$$M_2^2 = \frac{(k + 1)^2 M_1^4 \sin^2 \theta - 4 (M_1^2 \sin^2 \theta - 1) (k M_1^2 \sin^2 \theta + 1)}{(2k M_1^2 \sin^2 \theta - (k - 1)) ((k - 1) M_1^2 \sin^2 \theta + 2)} \tag{12.57}$$

The ratio of the total pressure can be expressed as

Stagnation Pressure Ratio

$$\frac{P_{02}}{P_{01}} = \left[ \frac{(k + 1) M_1^2 \sin^2 \theta}{(k - 1) M_1^2 \sin^2 \theta + 2} \right]^{\frac{k}{k-1}} \left[ \frac{k + 1}{2k M_1^2 \sin^2 \theta - (k - 1)} \right]^{\frac{1}{k-1}} \tag{12.58}$$

Even though the solution for these variables,  $M_1$  and  $\theta$ , is unique, the possible range deflection angle,  $\delta$ , is limited. Examining equation (12.51) shows that the shock angle,  $\theta$ , has to be in the range of  $\sin^{-1}(1/M_1) \geq \theta \geq (\pi/2)$  (see Figure 12.8). The range of given  $\theta$ , upstream Mach number  $M_1$ , is limited between  $\infty$  and  $\sqrt{1/\sin^2 \theta}$ .

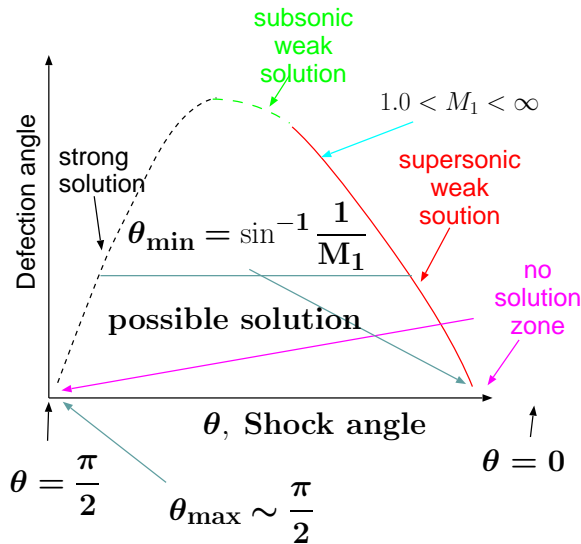

Fig. -12.8. The possible range of solutions for different parameters for given upstream Mach numbers.

### 12.2.2.4 Given Two Angles, $\delta$ and $\theta$

It is sometimes useful to obtain a relationship where the two angles are known. The first upstream Mach number,  $M_1$  is

<b>Mach Number Angles Relationship</b>
--

$$M_1^2 = \frac{2(\cot \theta + \tan \delta)}{\sin 2\theta - (\tan \delta)(k + \cos 2\theta)} \quad (12.59)$$

The reduced pressure difference is

$$\frac{2(P_2 - P_1)}{\rho U^2} = \frac{2 \sin \theta \sin \delta}{\cos(\theta - \delta)} \quad (12.60)$$

The reduced density is

$$\frac{\rho_2 - \rho_1}{\rho_2} = \frac{\sin \delta}{\sin \theta \cos(\theta - \delta)} \quad (12.61)$$

For a large upstream Mach number  $M_1$  and a small shock angle (yet not approaching zero),  $\theta$ , the deflection angle,  $\delta$  must also be small as well. Equation (12.51) can be simplified into

$$\theta \cong \frac{k+1}{2} \delta \quad (12.62)$$

The results are consistent with the initial assumption which shows that it was an appropriate assumption.

### 12.2.2.5 Flow in a Semi-2D Shape

**Example 12.2:**

*In Figure 12.9 exhibits wedge in a supersonic flow with unknown Mach number. Examination of the Figure reveals that it is in angle of attack. 1) Calculate the Mach number assuming that the lower and the upper Mach angles are identical and equal to  $\sim 30^\circ$  each (no angle of attack). 2) Calculate the Mach number and angle of attack assuming that the pressure after the shock for the two oblique shocks is equal. 3) What kind are the shocks exhibits in the image? (strong, weak, unsteady) 4) (Open question) Is there possibility to estimate the air stagnation temperature from the information provided in the image. You can assume that specific heats,  $k$  is a monotonic increasing function of the temperature.*

SOLUTION

#### Part (1)

The Mach angle and deflection angle can be obtained from the Figure 12.9. With this data and either using equation (12.59) or potto-GDC results in

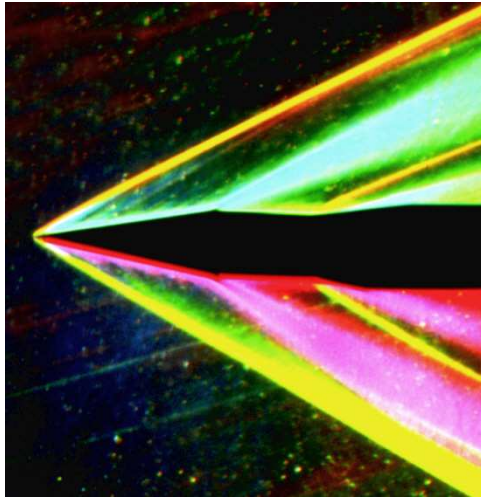

Fig. -12.9. Color-schlieren image of a two dimensional flow over a wedge. The total deflection angle (two sides) is  $20^\circ$  and upper and lower Mach angle are  $\sim 28^\circ$  and  $\sim 30^\circ$ , respectively. The image show the end-effects as it has thick (not sharp transition) compare to shock over a cone. The image was taken by Dr. Gary Settles at Gas Dynamics laboratory, Penn State University.

$M_1$	$M_x$	$M_{y_s}$	$M_{y_w}$	$\theta_s$	$\theta_w$	$\delta$	$\frac{P_{0y}}{P_{0x}}$
2.6810	2.3218	0	2.24	0	30	10	0.97172

The actual Mach number after the shock is then

$$M_2 = \frac{M_{2n}}{\sin(\theta - \delta)} = \frac{0.76617}{\sin(30 - 10)} = 0.839$$

The flow after the shock is subsonic flow.

### Part (2)

For the lower part shock angle of  $\sim 28^\circ$  the results are

$M_1$	$M_x$	$M_{y_s}$	$M_{y_w}$	$\theta_s$	$\theta_w$	$\delta$	$\frac{P_{0y}}{P_{0x}}$
2.9168	2.5754	0	2.437	0	28	10	0.96549

From the last table, it is clear that Mach number is between the two values of 2.9168 and 2.6810 and the pressure ratio is between 0.96549 and 0.97172. One of procedure to calculate the attack angle is such that pressure has to match by "guessing" the Mach number between the extreme values.

**Part (3)**

The shock must be weak shock because the shock angle is less than  $60^\circ$ .

---

End Solution

---

**12.2.2.6 Close and Far Views of the Oblique Shock**

In many cases, the close proximity view provides a continuous turning of the deflection angle,  $\delta$ . Yet, the far view shows a sharp transition. The traditional approach to reconcile these two views is by suggesting that the far view shock is a collection of many small weak shocks (see Figure 12.10). At the local view close to the wall, the oblique shock is a weak "weak oblique" shock. From the far view, the oblique shock is an accumulation of many small (or again weak) "weak shocks." However, these small "shocks" are built or accumulate into a large and abrupt change (shock). In this theory, the boundary layer (B.L.) does not enter into the calculation. In reality, the boundary layer increases the zone where a continuous flow exists. The boundary layer reduces the upstream flow velocity and therefore the shock does not exist at close proximity to the wall. In larger distance from the wall, the shock becomes possible.

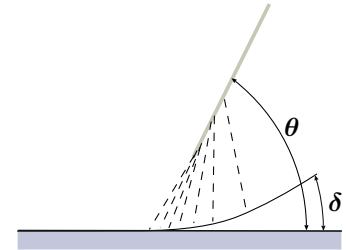

Fig. -12.10. A local and a far view of the oblique shock.

**12.2.2.7 Maximum Value of Oblique shock**

The maximum values are summarized in the following Table .

Table -12.1. Table of maximum values of the oblique Shock  $k=1.4$

$M_x$	$M_y$	$\delta_{\max}$	$\theta_{\max}$
1.1000	0.97131	1.5152	76.2762
1.2000	0.95049	3.9442	71.9555
1.3000	0.93629	6.6621	69.3645
1.4000	0.92683	9.4272	67.7023
1.5000	0.92165	12.1127	66.5676
1.6000	0.91941	14.6515	65.7972
1.7000	0.91871	17.0119	65.3066
1.8000	0.91997	19.1833	64.9668

Table -12.1. Maximum values of oblique shock (continue)  $k=1.4$ 

$M_x$	$M_y$	$\delta_{\max}$	$\theta_{\max}$
1.9000	0.92224	21.1675	64.7532
2.0000	0.92478	22.9735	64.6465
2.2000	0.93083	26.1028	64.6074
2.4000	0.93747	28.6814	64.6934
2.6000	0.94387	30.8137	64.8443
2.8000	0.94925	32.5875	65.0399
3.0000	0.95435	34.0734	65.2309
3.2000	0.95897	35.3275	65.4144
3.4000	0.96335	36.3934	65.5787
3.6000	0.96630	37.3059	65.7593
3.8000	0.96942	38.0922	65.9087
4.0000	0.97214	38.7739	66.0464
5.0000	0.98183	41.1177	66.5671
6.0000	0.98714	42.4398	66.9020
7.0000	0.99047	43.2546	67.1196
8.0000	0.99337	43.7908	67.2503
9.0000	0.99440	44.1619	67.3673
10.0000	0.99559	44.4290	67.4419

It must be noted that the calculations are for the perfect gas model. In some cases, this assumption might not be sufficient and different analysis is needed. Henderson and Menikoff<sup>15</sup> suggested a procedure to calculate the maximum deflection angle for arbitrary equation of state<sup>16</sup>.

When the mathematical quantity  $D$  becomes positive, for large deflection angle, there isn't a physical solution to an oblique shock. Since the flow "sees" the obstacle, the only possible reaction is by a normal shock which occurs at some distance from the

<sup>15</sup>Henderson and Menikoff "Triple Shock Entropy Theorem" Journal of Fluid Mechanics 366 (1998) pp. 179-210.

<sup>16</sup>The effect of the equation of state on the maximum and other parameters at this state is unknown at this moment and there are more works underway.

body. This shock is referred to as the detach shock. The detached shock's distance from the body is a complex analysis and should be left to graduate class and researchers in this area.

### 12.2.2.8 Oblique Shock Examples

Example 12.3:

Air flows at Mach number ( $M_1$ ) or  $M_x = 4$  is approaching a wedge. What is the maximum wedge angle at which the oblique shock can occur? If the wedge angle is  $20^\circ$ , calculate the weak, the strong Mach numbers, and the respective shock angles.

#### SOLUTION

The maximum wedge angle for ( $M_x = 4$ )  $D$  has to be equal to zero. The wedge angle that satisfies this requirement is by equation (12.28) (a side to the case proximity of  $\delta = 0$ ). The maximum values are:

$M_x$	$M_y$	$\delta_{\max}$	$\theta_{\max}$
4.0000	0.97234	38.7738	66.0407

To obtain the results of the weak and the strong solutions either utilize the equation (12.28) or the GDC which yields the following results

$M_x$	$M_{y_s}$	$M_{y_w}$	$\theta_s$	$\theta_w$	$\delta$
4.0000	0.48523	2.5686	1.4635	0.56660	0.34907

End Solution

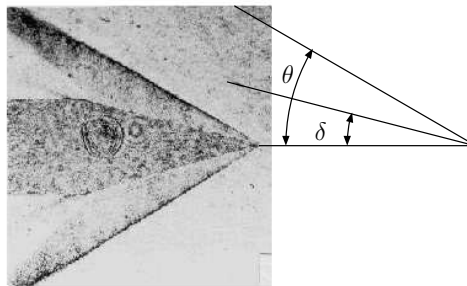

Fig. -12.11. Oblique shock occurs around a cone. This photo is courtesy of Dr. Grigory Toker, a Research Professor at Cuernavaco University of Mexico. According to his measurement, the cone half angle is  $15^\circ$  and the Mach number is 2.2.



Example 12.4:

A cone shown in Figure (12.11) is exposed to supersonic flow and create an oblique shock. Is the shock shown in the photo weak or strong shock? Explain. Using the geometry provided in the photo, predict at which Mach number was the photo taken based on the assumption that the cone is a wedge.

SOLUTION

The measurement shows that cone angle is  $14.43^\circ$  and the shock angle is  $30.099^\circ$ . With given two angles the solution can be obtained by utilizing equation (12.59) or the Potto-GDC.

$M_1$	$M_{y_s}$	$M_{y_w}$	$\theta_s$	$\theta_w$	$\delta$	$\frac{P_{0y}}{P_{0x}}$
3.2318	0.56543	2.4522	71.0143	30.0990	14.4300	0.88737

Because the flow is around the cone it must be a weak shock. Even if the cone was a wedge, the shock would be weak because the maximum (transition to a strong shock) occurs at about  $60^\circ$ . Note that the Mach number is larger than the one predicted by the wedge.

End Solution

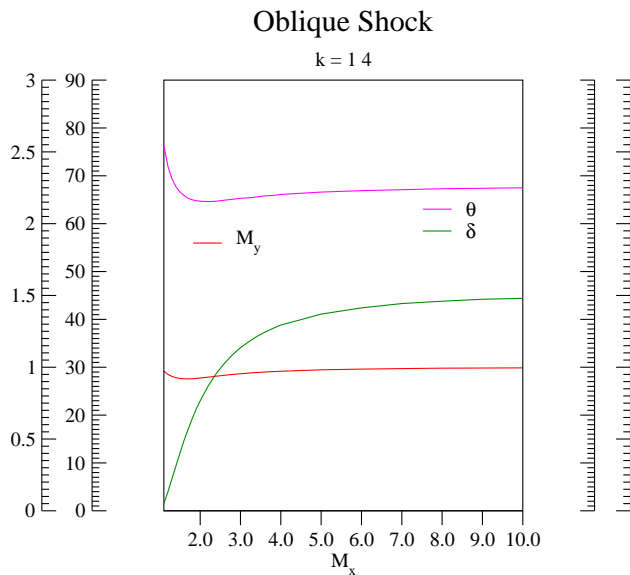

Thu Jun 30 15:14:53 2005

Fig. -12.12. Maximum values of the properties in an oblique shock.

### 12.2.3 Application of Oblique Shock

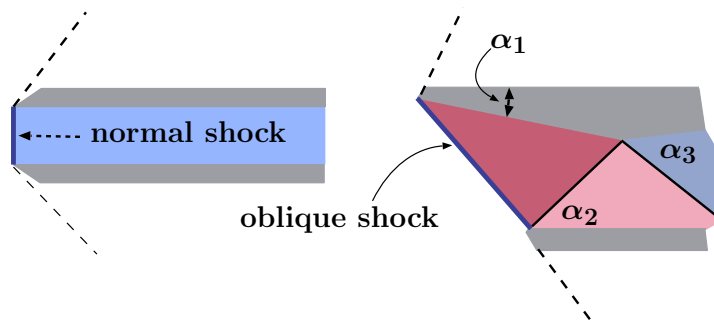

Fig. -12.13. Two variations of inlet suction for supersonic flow.

One of the practical applications of the oblique shock is the design of an inlet suction for a supersonic flow. It is suggested that a series of weak shocks should replace one normal shock to increase the efficiency (see Figure (12.13))<sup>17</sup>. Clearly, with a proper design, the flow can be brought to a subsonic flow just below  $M = 1$ . In such a case, there is less entropy production (less pressure loss). To illustrate the design significance of the oblique shock, the following example is provided.

#### Example 12.5:

The Section described in Figure 12.13 and 12.14 air is flowing into a suction section at  $M = 2.0$ ,  $P = 1.0[\text{bar}]$ , and  $T = 17^\circ\text{C}$ . Compare the different conditions in the two different configurations. Assume that only a weak shock occurs.

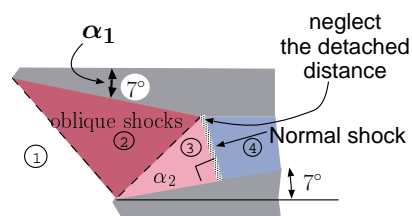

Fig. -12.14. Schematic for Example (12.5).

#### SOLUTION

The first configuration is of a normal shock for which the results<sup>18</sup> are

$M_x$	$M_y$	$\frac{T_y}{T_x}$	$\frac{\rho_y}{\rho_x}$	$\frac{P_y}{P_x}$	$\frac{P_{0y}}{P_{0x}}$
2.0000	0.57735	1.6875	2.6667	4.5000	0.72087

<sup>17</sup>In fact, there is general proof that regardless to the equation of state (any kind of gas), the entropy is to be minimized through a series of oblique shocks rather than through a single normal shock. For details see Henderson and Menikoff "Triple Shock Entropy Theorem," Journal of Fluid Mechanics 366, (1998) pp. 179–210.

<sup>18</sup>The results in this example are obtained using the graphical interface of POTTO-GDC thus, no input explanation is given. In the past the input file was given but the graphical interface it is no longer needed.

In the oblique shock, the first angle shown is

$M_x$	$M_{y_s}$	$M_{y_w}$	$\theta_s$	$\theta_w$	$\delta$	$\frac{P_{0y}}{P_{0x}}$
2.0000	0.58974	1.7498	85.7021	36.2098	7.0000	0.99445

and the additional information by the minimal info in the Potto-GDC is

$M_x$	$M_{y_w}$	$\theta_w$	$\delta$	$\frac{P_y}{P_x}$	$\frac{T_y}{T_x}$	$\frac{P_{0y}}{P_{0x}}$
2.0000	1.7498	36.2098	7.0000	1.2485	1.1931	0.99445

In the new region, the new angle is  $7^\circ + 7^\circ$  with new upstream Mach number of  $M_x = 1.7498$  resulting in

$M_x$	$M_{y_s}$	$M_{y_w}$	$\theta_s$	$\theta_w$	$\delta$	$\frac{P_{0y}}{P_{0x}}$
1.7498	0.71761	1.2346	76.9831	51.5549	14.0000	0.96524

And the additional information is

$M_x$	$M_{y_w}$	$\theta_w$	$\delta$	$\frac{P_y}{P_x}$	$\frac{T_y}{T_x}$	$\frac{P_{0y}}{P_{0x}}$
1.7498	1.5088	41.8770	7.0000	1.2626	1.1853	0.99549

An oblique shock is not possible and normal shock occurs. In such a case, the results are:

$M_x$	$M_y$	$\frac{T_y}{T_x}$	$\frac{\rho_y}{\rho_x}$	$\frac{P_y}{P_x}$	$\frac{P_{0y}}{P_{0x}}$
1.2346	0.82141	1.1497	1.4018	1.6116	0.98903

With two weak shock waves and a normal shock the total pressure loss is

$$\frac{P_{04}}{P_{01}} = \frac{P_{04}}{P_{03}} \frac{P_{03}}{P_{02}} \frac{P_{02}}{P_{01}} = 0.98903 \times 0.96524 \times 0.99445 = 0.9496$$

The static pressure ratio for the second case is

$$\frac{P_4}{P_1} = \frac{P_4}{P_3} \frac{P_3}{P_2} \frac{P_2}{P_1} = 1.6116 \times 1.2626 \times 1.285 = 2.6147$$

The loss in this case is much less than in a direct normal shock. In fact, the loss in the normal shock is above than 31% of the total pressure.

**Example 12.6:**

A supersonic flow is approaching a very long two-dimensional blunt wedge and creates a detached shock at Mach 3.5 (see Figure 12.15). The half wedge angle is  $10^\circ$ . What is the required “throat” area ratio to achieve acceleration from the subsonic region to the supersonic region assuming the flow is one-dimensional?

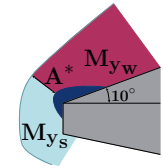

Fig. -12.15. Schematic for Example (12.6).

SOLUTION

The detached shock is a normal shock and the results are

$M_x$	$M_y$	$\frac{T_y}{T_x}$	$\frac{\rho_y}{\rho_x}$	$\frac{P_y}{P_x}$	$\frac{P_{0y}}{P_{0x}}$
3.5000	0.45115	3.3151	4.2609	14.1250	0.21295

Now utilizing the isentropic relationship for  $k = 1.4$  yields

$M$	$\frac{T}{T_0}$	$\frac{\rho}{\rho_0}$	$\frac{A}{A^*}$	$\frac{P}{P_0}$	$\frac{A \times P}{A^* \times P_0}$
0.45115	0.96089	0.90506	1.4458	0.86966	1.2574

Thus the area ratio has to be 1.4458. Note that the pressure after the weak shock is irrelevant to the area ratio between the normal shock and the “throat” according to the standard nozzle analysis.

End Solution

**Example 12.7:**

The effects of a double wedge are explained in the government web site as shown in Figure 12.16. Adopt this description and assume that the turn of  $6^\circ$  is made of two equal angles of  $3^\circ$  (see Figure 12.16). Assume that there are no boundary layers and all the shocks are weak and straight. Perform the calculation for  $M_1 = 3.0$ . Find the required angle of shock BE. Then, explain why this description has internal conflict.

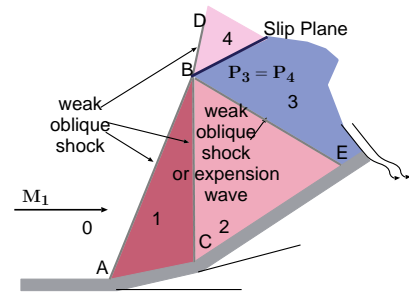

Fig. -12.16. Schematic of two angles turn with two weak shocks.

SOLUTION

The shock BD is an oblique shock with a response to a total turn of  $6^\circ$ . The conditions for this shock are:

$M_x$	$M_{y_s}$	$M_{y_w}$	$\theta_s$	$\theta_w$	$\delta$	$\frac{P_{0y}}{P_{0x}}$
3.0000	0.48013	2.7008	87.8807	23.9356	6.0000	0.99105

The transition for shock AB is

$M_x$	$M_{y_s}$	$M_{y_w}$	$\theta_s$	$\theta_w$	$\delta$	$\frac{P_{0y}}{P_{0x}}$
3.0000	0.47641	2.8482	88.9476	21.5990	3.0000	0.99879

For the shock BC the results are

$M_x$	$M_{y_s}$	$M_{y_w}$	$\theta_s$	$\theta_w$	$\delta$	$\frac{P_{0y}}{P_{0x}}$
2.8482	0.48610	2.7049	88.8912	22.7080	3.0000	0.99894

And the isentropic relationships for  $M = 2.7049, 2.7008$  are

$M$	$\frac{T}{T_0}$	$\frac{\rho}{\rho_0}$	$\frac{A}{A^*}$	$\frac{P}{P_0}$	$\frac{A \times P}{A^* \times P_0}$
2.7049	0.40596	0.10500	3.1978	0.04263	0.13632
2.7008	0.40669	0.10548	3.1854	0.04290	0.13665

The combined shocks AB and BC provide the base of calculating the total pressure ratio at zone 3. The total pressure ratio at zone 2 is

$$\frac{P_{02}}{P_{00}} = \frac{P_{02}}{P_{01}} \frac{P_{01}}{P_{00}} = 0.99894 \times 0.99879 = 0.997731283$$

On the other hand, the pressure at 4 has to be

$$\frac{P_4}{P_{01}} = \frac{P_4}{P_{04}} \frac{P_{04}}{P_{01}} = 0.04290 \times 0.99105 = 0.042516045$$

The static pressure at zone 4 and zone 3 have to match according to the government suggestion hence, the angle for BE shock which cause this pressure ratio needs to be found. To do that, check whether the pressure at 2 is above or below or above the pressure (ratio) in zone 4.

$$\frac{P_2}{P_{02}} = \frac{P_{02}}{P_{00}} \frac{P_2}{P_{02}} = 0.997731283 \times 0.04263 = 0.042436789$$

Since  $\frac{P_2}{P_{02}} < \frac{P_4}{P_{01}}$  a weak shock must occur to increase the static pressure (see Figure 11.13). The increase has to be

$$P_3/P_2 = 0.042516045/0.042436789 = 1.001867743$$

To achieve this kind of pressure ratio the perpendicular component has to be

$M_x$	$M_y$	$\frac{T_y}{T_x}$	$\frac{\rho_y}{\rho_x}$	$\frac{P_y}{P_x}$	$\frac{P_{0y}}{P_{0x}}$
1.0008	0.99920	1.0005	1.0013	1.0019	1.00000

The shock angle,  $\theta$  can be calculated from

$$\theta = \sin^{-1} 1.0008/2.7049 = 21.715320879^\circ$$

The deflection angle for such shock angle with Mach number is

$M_x$	$M_{y_s}$	$M_{y_w}$	$\theta_s$	$\theta_w$	$\delta$	$\frac{P_{0y}}{P_{0x}}$
2.7049	0.49525	2.7037	0.0	21.72	0.02623	1.00000

From the last calculation it is clear that the government proposed schematic of the double wedge is in conflict with the boundary condition. The flow in zone 3 will flow into the wall in about  $2.7^\circ$ . In reality the flow of double wedge will produce a curved shock surface with several zones. Only when the flow is far away from the double wedge, the flow behaves as only one theoretical angle of  $6^\circ$  exist.

End Solution

#### Example 12.8:

Calculate the flow deflection angle and other parameters downstream when the Mach angle is  $34^\circ$  and  $P_1 = 3[\text{bar}]$ ,  $T_1 = 27^\circ\text{C}$ , and  $U_1 = 1000\text{m/sec}$ . Assume  $k = 1.4$  and  $R = 287\text{J/KgK}$ .

#### SOLUTION

The Mach angle of  $34^\circ$  is below maximum deflection which means that it is a weak shock. Yet, the Upstream Mach number,  $M_1$ , has to be determined

$$M_1 = \frac{U_1}{\sqrt{kRT}} = \frac{1000}{1.4 \times 287 \times 300} = 2.88$$

Using this Mach number and the Mach deflection in either using the Table or the figure or POTTO-GDC results in

$M_x$	$M_{y_s}$	$M_{y_w}$	$\theta_s$	$\theta_w$	$\delta$	$\frac{P_{0y}}{P_{0x}}$
2.8800	0.48269	2.1280	0.0	34.00	15.78	0.89127

The relationship for the temperature and pressure can be obtained by using equation (12.15) and (12.13) or simply converting the  $M_1$  to perpendicular component.

$$M_{1n} = M_1 * \sin \theta = 2.88 \sin(34.0) = 1.61$$

From the Table (11.3) or GDC the following can be obtained.

$M_x$	$M_y$	$\frac{T_y}{T_x}$	$\frac{\rho_y}{\rho_x}$	$\frac{P_y}{P_x}$	$\frac{P_{0y}}{P_{0x}}$
1.6100	0.66545	1.3949	2.0485	2.8575	0.89145

The temperature ratio combined upstream temperature yield

$$T_2 = 1.3949 \times 300 \sim 418.5K$$

and the same for the pressure

$$P_2 = 2.8575 \times 3 = 8.57[\text{bar}]$$

And the velocity

$$U_{n2} = M_{y_w} \sqrt{kRT} = 2.128 \sqrt{1.4 \times 287 \times 418.5} = 872.6[\text{m/sec}]$$

---

End Solution

---

**Example 12.9:**

For Mach number 2.5 and wedge with a total angle of  $22^\circ$ , calculate the ratio of the stagnation pressure.

SOLUTION

Utilizing GDC for Mach number 2.5 and the angle of  $11^\circ$  results in

$M_x$	$M_{y_s}$	$M_{y_w}$	$\theta_s$	$\theta_w$	$\delta$	$\frac{P_{0y}}{P_{0x}}$
2.5000	0.53431	2.0443	85.0995	32.8124	11.0000	0.96873

---

End Solution

---

**Example 12.10:**

What is the maximum pressure ratio that can be obtained on wedge when the gas is flowing in 2.5 Mach without any close boundaries? Would it make any difference if the wedge was flowing into the air? If so, what is the difference?

SOLUTION

It has to be recognized that without any other boundary condition, the shock is weak shock. For a weak shock the maximum pressure ratio is obtained at the deflection point because it is closest to a normal shock. To obtain the maximum point for 2.5 Mach number, either use the Maximum Deflection Mach number's equation or the Potto-GDC

$M_x$	$M_{y_{\max}}$	$\theta_{\max}$	$\delta$	$\frac{P_y}{P_x}$	$\frac{T_y}{T_x}$	$\frac{P_{0y}}{P_{0x}}$
2.5000	0.94021	64.7822	29.7974	4.3573	2.6854	0.60027

In these calculations, Maximum Deflection Mach's equation was used to calculate the normal component of the upstream, then the Mach angle was calculated using the geometrical relationship of  $\theta = \sin^{-1} M_{1n}/M_1$ . With these two quantities, utilizing equation (12.12) the deflection angle,  $\delta$ , is obtained.

---

End Solution

---

### Example 12.11:

Consider the schematic shown in the following figure. Assume that the upstream Mach number is 4 and the deflection angle is  $\delta = 15^\circ$ . Compute the pressure ratio and the temperature ratio after the second shock (sometimes referred to as the reflective shock while the first shock is called the incidental shock).

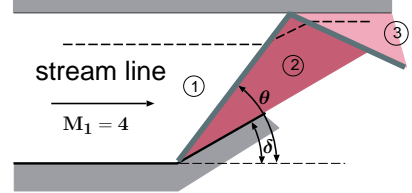

Fig. -12.17. Schematic for Example (12.11).

### SOLUTION

This kind of problem is essentially two wedges placed in a certain geometry. It is clear that the flow must be parallel to the wall. For the first shock, the upstream Mach number is known together with deflection angle. Utilizing the table or the Potto-GDC, the following can be obtained:

$M_x$	$M_{y_s}$	$M_{y_w}$	$\theta_s$	$\theta_w$	$\delta$	$\frac{P_{0y}}{P_{0x}}$
4.0000	0.46152	2.9290	85.5851	27.0629	15.0000	0.80382

And the additional information by using minimal information ratio button in Potto-GDC is

$M_x$	$M_{y_w}$	$\theta_w$	$\delta$	$\frac{P_y}{P_x}$	$\frac{T_y}{T_x}$	$\frac{P_{0y}}{P_{0x}}$
4.0000	2.9290	27.0629	15.0000	1.7985	1.7344	0.80382

With a Mach number of  $M = 2.929$ , the second deflection angle is also  $15^\circ$ . With these values the following can be obtained:

$M_x$	$M_{y_s}$	$M_{y_w}$	$\theta_s$	$\theta_w$	$\delta$	$\frac{P_{0y}}{P_{0x}}$
2.9290	0.51367	2.2028	84.2808	32.7822	15.0000	0.90041

and the additional information is



$M_x$	$M_{y_w}$	$\theta_w$	$\delta$	$\frac{P_y}{P_x}$	$\frac{T_y}{T_x}$	$\frac{P_{0y}}{P_{0x}}$
2.9290	2.2028	32.7822	15.0000	1.6695	1.5764	0.90041

With the combined tables the ratios can be easily calculated. Note that hand calculations requires endless time looking up graphical representation of the solution. Utilizing the POTTO–GDC which provides a solution in just a few clicks.

$$\frac{P_1}{P_3} = \frac{P_1 P_2}{P_2 P_3} = 1.7985 \times 1.6695 = 3.0026$$

$$\frac{T_1}{T_3} = \frac{T_1 T_2}{T_2 T_3} = 1.7344 \times 1.5764 = 2.632$$

---

End Solution

---

### Example 12.12:

A similar example as before but here Mach angle is  $29^\circ$  and Mach number is 2.85. Again calculate the downstream ratios after the second shock and the deflection angle.

### SOLUTION

Here the Mach number and the Mach angle are given. With these pieces of information by utilizing the Potto–GDC the following is obtained:

$M_x$	$M_{y_s}$	$M_{y_w}$	$\theta_s$	$\theta_w$	$\delta$	$\frac{P_{0y}}{P_{0x}}$
2.8500	0.48469	2.3575	0.0	29.00	10.51	0.96263

and the additional information by utilizing the minimal info button in GDC provides

$M_x$	$M_{y_w}$	$\theta_w$	$\delta$	$\frac{P_y}{P_x}$	$\frac{T_y}{T_x}$	$\frac{P_{0y}}{P_{0x}}$
2.8500	2.3575	29.0000	10.5131	1.4089	1.3582	0.96263

With the deflection angle of  $\delta = 10.51$  the so called reflective shock gives the following information

$M_x$	$M_{y_s}$	$M_{y_w}$	$\theta_s$	$\theta_w$	$\delta$	$\frac{P_{0y}}{P_{0x}}$
2.3575	0.54894	1.9419	84.9398	34.0590	10.5100	0.97569

and the additional information of

$M_x$	$M_{y_w}$	$\theta_w$	$\delta$	$\frac{P_y}{P_x}$	$\frac{T_y}{T_x}$	$\frac{P_{0y}}{P_{0x}}$
2.3575	1.9419	34.0590	10.5100	1.3984	1.3268	0.97569

$$\frac{P_1}{P_3} = \frac{P_1 P_2}{P_2 P_3} = 1.4089 \times 1.3984 \sim 1.97$$

$$\frac{T_1}{T_3} = \frac{T_1 T_2}{T_2 T_3} = 1.3582 \times 1.3268 \sim 1.8021$$

---

End Solution

---

**Example 12.13:**

Compare a direct normal shock to oblique shock with a normal shock. Where will the total pressure loss (entropy) be larger? Assume that upstream Mach number is 5 and the first oblique shock has Mach angle of  $30^\circ$ . What is the deflection angle in this case?

SOLUTION

For the normal shock the results are

$M_x$	$M_y$	$\frac{T_y}{T_x}$	$\frac{\rho_y}{\rho_x}$	$\frac{P_y}{P_x}$	$\frac{P_{0y}}{P_{0x}}$
5.0000	0.41523	5.8000	5.0000	29.0000	0.06172

While the results for the oblique shock are

$M_x$	$M_{y_s}$	$M_{y_w}$	$\theta_s$	$\theta_w$	$\delta$	$\frac{P_{0y}}{P_{0x}}$
5.0000	0.41523	3.0058	0.0	30.00	20.17	0.49901

And the additional information is

$M_x$	$M_{y_w}$	$\theta_w$	$\delta$	$\frac{P_y}{P_x}$	$\frac{T_y}{T_x}$	$\frac{P_{0y}}{P_{0x}}$
5.0000	3.0058	30.0000	20.1736	2.6375	2.5141	0.49901

The normal shock that follows this oblique is

$M_x$	$M_y$	$\frac{T_y}{T_x}$	$\frac{\rho_y}{\rho_x}$	$\frac{P_y}{P_x}$	$\frac{P_{0y}}{P_{0x}}$
3.0058	0.47485	2.6858	3.8625	10.3740	0.32671

The pressure ratios of the oblique shock with normal shock is the total shock in the second case.

$$\frac{P_1}{P_3} = \frac{P_1 P_2}{P_2 P_3} = 2.6375 \times 10.374 \sim 27.36$$

$$\frac{T_1}{T_3} = \frac{T_1 T_2}{T_2 T_3} = 2.5141 \times 2.6858 \sim 6.75$$

Note the static pressure raised is less than the combination shocks as compared to the normal shock but the total pressure has the opposite result.

End Solution

**Example 12.14:**

A flow in a tunnel ends up with two deflection angles from both sides (see the following Figure 12.14). For upstream Mach number of 5 and deflection angle of 12° and 15°, calculate the pressure at zones 3 and 4 based on the assumption that the slip plane is half of the difference between the two deflection angles. Based on these calculations, explain whether the slip angle is larger or smaller than the difference of the deflection angle.

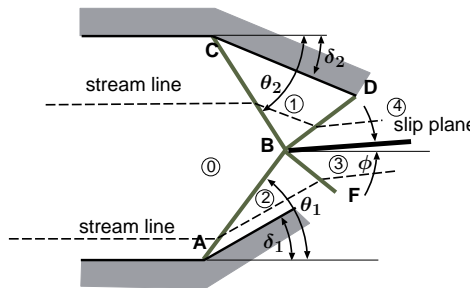

Fig. -12.18. Illustration for Example (12.14).

SOLUTION

The first two zones immediately after are computed using the same techniques that were developed and discussed earlier.

For the first direction of 15° and Mach number =5.

$M_x$	$M_{y_s}$	$M_{y_w}$	$\theta_s$	$\theta_w$	$\delta$	$\frac{P_{0y}}{P_{0x}}$
5.0000	0.43914	3.5040	86.0739	24.3217	15.0000	0.69317

And the additional conditions are

$M_x$	$M_{y_w}$	$\theta_w$	$\delta$	$\frac{P_y}{P_x}$	$\frac{T_y}{T_x}$	$\frac{P_{0y}}{P_{0x}}$
5.0000	3.5040	24.3217	15.0000	1.9791	1.9238	0.69317

For the second direction of 12° and Mach number =5.

$M_x$	$M_{y_s}$	$M_{y_w}$	$\theta_s$	$\theta_w$	$\delta$	$\frac{P_{0y}}{P_{0x}}$
5.0000	0.43016	3.8006	86.9122	21.2845	12.0000	0.80600

And the additional conditions are

$M_x$	$M_{y_w}$	$\theta_w$	$\delta$	$\frac{P_y}{P_x}$	$\frac{T_y}{T_x}$	$\frac{P_{0y}}{P_{0x}}$
5.0000	3.8006	21.2845	12.0000	1.6963	1.6625	0.80600

The conditions in zone 4 and zone 3 have two things that are equal. They are the pressure and the velocity direction. It has to be noticed that the velocity magnitudes in zone 3 and 4 do not have to be equal. This non-continuous velocity profile can occur in our model because it is assumed that fluid is non-viscous.

If the two sides were equal because of symmetry the slip angle is also zero. It is to say, for the analysis, that only one deflection angle exist. For the two different deflection angles, the slip angle has two extreme cases. The first case is where match lower deflection angle and second is to match the higher deflection angle. In this case, it is assumed that the slip angle moves half of the angle to satisfy both of the deflection angles (first approximation). Under this assumption the conditions in zone 3 are solved by looking at the deflection angle of  $12^\circ + 1.5^\circ = 13.5^\circ$  which results in

$M_x$	$M_{y_s}$	$M_{y_w}$	$\theta_s$	$\theta_w$	$\delta$	$\frac{P_{0y}}{P_{0x}}$
3.5040	0.47413	2.6986	85.6819	27.6668	13.5000	0.88496

with the additional information

$M_x$	$M_{y_w}$	$\theta_w$	$\delta$	$\frac{P_y}{P_x}$	$\frac{T_y}{T_x}$	$\frac{P_{0y}}{P_{0x}}$
3.5040	2.6986	27.6668	13.5000	1.6247	1.5656	0.88496

And in zone 4 the conditions are due to deflection angle of  $13.5^\circ$  and Mach 3.8006

$M_x$	$M_{y_s}$	$M_{y_w}$	$\theta_s$	$\theta_w$	$\delta$	$\frac{P_{0y}}{P_{0x}}$
3.8006	0.46259	2.9035	85.9316	26.3226	13.5000	0.86179

with the additional information

$M_x$	$M_{y_w}$	$\theta_w$	$\delta$	$\frac{P_y}{P_x}$	$\frac{T_y}{T_x}$	$\frac{P_{0y}}{P_{0x}}$
3.8006	2.9035	26.3226	13.5000	1.6577	1.6038	0.86179

From these tables the pressure ratio at zone 3 and 4 can be calculated

$$\frac{P_3}{P_4} = \frac{P_3}{P_2} \frac{P_2}{P_0} \frac{P_0}{P_1} \frac{P_1}{P_4} = 1.6247 \times 1.9791 \frac{1}{1.6963} \frac{1}{1.6038} \sim 1.18192$$

To reduce the pressure ratio the deflection angle has to be reduced (remember that at weak weak shock almost no pressure change). Thus, the pressure at zone 3 has to be reduced. To reduce the pressure the angle of slip plane has to increase from 1.5° to a larger number.

————— End Solution —————

**Example 12.15:**

*The previous example gave rise to another question on the order of the deflection angles. Consider the same values as previous analysis, will the oblique shock with first angle of 15° and then 12° or opposite order make a difference (M = 5)? If not what order will make a bigger entropy production or pressure loss? (No general proof is needed).*

SOLUTION

Waiting for the solution

————— End Solution —————

**12.2.3.1 Retouch of Shock Drag or Wave Drag**

Since it was established that the common explanation is erroneous and the steam lines are bending/changing direction when they touching the oblique shock (compare with figure (11.15)). The correct explanation is that increase of the momentum into control volume is either requires increase of the force and/or results in acceleration of gas. So, what is the effects of the oblique shock on the Shock Drag? Figure (12.19) exhibits schematic of the oblique shock which show clearly that stream lines are bended. There two main points that should be discussed in this context are the additional effects and infinite/final structure. The additional effects are the mass start to have a vertical component. The vertical component one hand increase the energy needed and thus increase need to move the body (larger shock drag) (note the there is a zero momentum net change for symmetrical bodies.). However, the oblique shock reduces the normal component that undergoes the shock and hence the total shock drag is reduced. The oblique shock creates a finite amount of drag (momentum and energy lost) while a normal shock as indirectly implied in the common explanation creates de facto situation where the shock grows to be infinite which of course impossible.

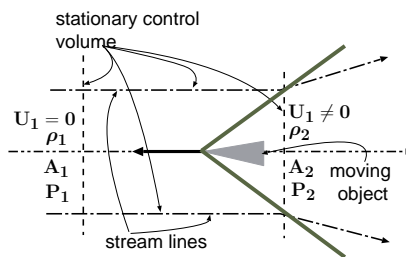

*Fig. -12.19. The diagram that explains the shock drag effects of a moving shock considering the oblique shock effects.*

It should be noted that, oblique shock becomes less “oblique” and more parallel when other effects start to kick in.

### 12.3 Prandtl-Meyer Function

#### 12.3.1 Introduction

As discussed in Chapter ?? when the deflection turns to the opposite direction of the flow, the flow accelerates to match the boundary condition. The transition, as opposed to the oblique shock, is smooth, without any jump in properties. Here because of the tradition, the deflection angle is denoted as a positive when it is away from the flow (see Figure 12.21). In a somewhat a similar concept to oblique shock there exists a “detachment” point above which this model breaks and another model has to be implemented. Yet, when this model breaks down, the flow becomes complicated, flow separation occurs, and no known simple model can describe the situation. As opposed to the oblique shock, there is no limitation for the Prandtl-Meyer function to approach zero. Yet, for very small angles, because of imperfections of the wall and the boundary layer, it has to be assumed to be insignificant.

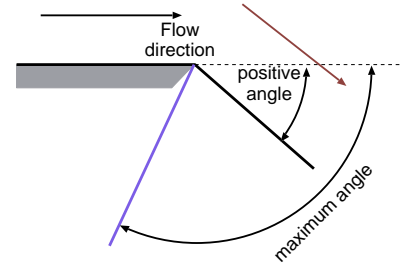

Fig. -12.21. The definition of the angle for the Prandtl–Meyer function.

Supersonic expansion and isentropic compression (Prandtl-Meyer function), are an extension of the Mach line concept. The Mach line shows that a disturbance in a field of supersonic flow moves in an angle of  $\mu$ , which is defined as (as shown in Figure 12.22)

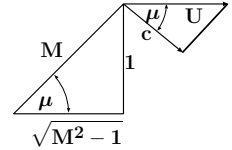

Fig. -12.22. The angles of the Mach line triangle.

$$\mu = \sin^{-1} \left( \frac{1}{M} \right) \tag{12.63}$$

or

$$\mu = \tan^{-1} \frac{1}{\sqrt{M^2 - 1}} \tag{12.64}$$

A Mach line results because of a small disturbance in the wall contour. This Mach line is assumed to be a result of the positive angle. The reason that a “negative” angle is not applicable is that the coalescing of the small Mach wave which results in a shock wave. However, no shock is created from many small positive angles.

The Mach line is the chief line in the analysis because of the wall contour shape information propagates along this line. Once the contour is changed, the flow direction will change to fit the wall. This direction change results in a change of the flow properties, and it is assumed here to be isotropic for a positive angle. This assumption,

as it turns out, is close to reality. In this chapter, a discussion on the relationship between the flow properties and the flow direction is presented.

### 12.3.2 Geometrical Explanation

The change in the flow direction is assumed to be result of the change in the tangential component. Hence, the total Mach number increases. Therefore, the Mach angle increase and result in a change in the direction of the flow. The velocity component in the direction of the Mach line is assumed to be constant to satisfy the assumption that the change is a result of the contour only. Later, this assumption will be examined. The typical simplifications for geometrical functions are used:

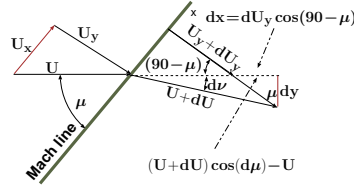

Fig. -12.23. The schematic of the turning flow.

$$\begin{aligned} d\nu &\sim \sin(d\nu); \\ \cos(d\nu) &\sim 1 \end{aligned} \tag{12.65}$$

These simplifications are the core reasons why the change occurs only in the perpendicular direction ( $d\nu \ll 1$ ). The change of the velocity in the flow direction,  $dx$  is

$$dx = (U + dU) \cos \nu - U = dU \tag{12.66}$$

In the same manner, the velocity perpendicular to the flow,  $dy$ , is

$$dy = (U + dU) \sin(d\nu) = U d\nu \tag{12.67}$$

The  $\tan \mu$  is the ratio of  $dy/dx$  (see Figure (12.23))

$$\tan \mu = \frac{dx}{dy} = \frac{dU}{U d\nu} \tag{12.68}$$

The ratio  $dU/U$  was shown to be

$$\frac{dU}{U} = \frac{dM^2}{2M^2 \left(1 + \frac{k-1}{2} M^2\right)} \tag{12.69}$$

Combining equations (12.68) and (12.69) transforms it into

$$d\nu = -\frac{\sqrt{M^2 - 1} dM^2}{2M^2 \left(1 + \frac{k-1}{2} M^2\right)} \tag{12.70}$$

After integration of equation (12.70) becomes

Turning Angle

$$\nu(M) = -\sqrt{\frac{k+1}{k-1}} \tan^{-1} \sqrt{\frac{k-1}{k+1}} (M^2 - 1) + \tan^{-1} \sqrt{(M^2 - 1)} + \text{constant}$$

(12.71)

The constant can be chosen in a such a way that  $\nu = 0$  at  $M = 1$ .

### 12.3.3 Alternative Approach to Governing Equations

In the previous section, a simplified version was derived based on geometrical arguments. In this section, a more rigorous explanation is provided. It must be recognized that here the cylindrical coordinates are advantageous because the flow turns around a single point.

For this coordinate system, the mass conservation can be written as

$$\frac{\partial(\rho r U_r)}{\partial r} + \frac{\partial(\rho U_\theta)}{\partial \theta} = 0 \quad (12.72)$$

The momentum equations are expressed as

$$U_r \frac{\partial U_r}{\partial r} + \frac{U_\theta}{r} \frac{\partial U_r}{\partial \theta} - \frac{U_\theta^2}{r} = -\frac{1}{\rho} \frac{\partial P}{\partial r} = -\frac{c^2}{\rho} \frac{\partial \rho}{\partial r} \quad (12.73)$$

and

$$U_r \frac{\partial U_\theta}{\partial r} + \frac{U_\theta}{r} \frac{\partial U_\theta}{\partial \theta} - \frac{U_\theta U_r}{r} = -\frac{1}{r\rho} \frac{\partial P}{\partial \theta} = -\frac{c^2}{r\rho} \frac{\partial \rho}{\partial \theta} \quad (12.74)$$

If the assumption is that the flow isn't a function of the radius,  $r$ , then all the derivatives with respect to the radius will vanish. One has to remember that when  $r$  enters to the function, like the first term in the mass equation, the derivative isn't zero. Hence, the mass equation is reduced to

$$\rho U_r + \frac{\partial(\rho U_\theta)}{\partial \theta} = 0 \quad (12.75)$$

Equation (12.75) can be rearranged as transformed into

$$-\frac{1}{U_\theta} \left( U_r + \frac{\partial U_\theta}{\partial \theta} \right) = \frac{1}{\rho} \frac{\partial \rho}{\partial \theta} \quad (12.76)$$

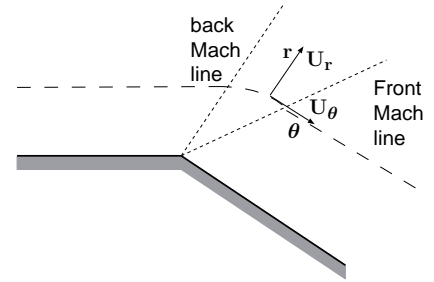

Fig. -12.24. The schematic of the coordinate based on the mathematical description.



The momentum equations now obtain the form of

$$\begin{aligned} \frac{U_\theta}{r} \frac{\partial U_r}{\partial \theta} - \frac{U_\theta^2}{r} &= 0 \\ U_\theta \left( \frac{\partial U_r}{\partial \theta} - U_\theta \right) &= 0 \end{aligned} \quad (12.77)$$

$$\begin{aligned} \frac{U_\theta}{r} \frac{\partial U_\theta}{\partial \theta} - \frac{U_\theta U_r}{r} &= -\frac{c^2}{r\rho} \frac{\partial \rho}{\partial \theta} \\ U_\theta \left( \frac{\partial U_\theta}{\partial \theta} - U_r \right) &= -\frac{c^2}{\rho} \frac{\partial \rho}{\partial \theta} \end{aligned} \quad (12.78)$$

Substituting the term  $\frac{1}{\rho} \frac{\partial \rho}{\partial \theta}$  from equation (12.76) into equation (12.78) results in

$$U_\theta \left( \frac{\partial U_\theta}{\partial \theta} - U_r \right) = \frac{c^2}{U_\theta} \left( U_r + \frac{\partial U_\theta}{\partial \theta} \right) \quad (12.79)$$

or

$$U_\theta^2 \left( U_r + \frac{\partial U_\theta}{\partial \theta} \right) = c^2 \left( U_r + \frac{\partial U_\theta}{\partial \theta} \right) \quad (12.80)$$

And an additional rearrangement results in

$$(c^2 - U_\theta^2) \left( U_r + \frac{\partial U_\theta}{\partial \theta} \right) = 0 \quad (12.81)$$

From equation (12.81) it follows that

$$U_\theta = c \quad (12.82)$$

It is remarkable that the tangential velocity at every turn is at the speed of sound! It must be pointed out that the total velocity isn't at the speed of sound, but only the tangential component. In fact, based on the definition of the Mach angle, the component shown in Figure (12.23) under  $U_y$  is equal to the speed of sound,  $M = 1$ .

After some additional rearrangement, equation (12.77) becomes

$$\frac{U_\theta}{r} \left( \frac{\partial U_r}{\partial \theta} - U_\theta \right) = 0 \quad (12.83)$$

If  $r$  isn't approaching infinity,  $\infty$  and since  $U_\theta \neq 0$  leads to

$$\frac{\partial U_r}{\partial \theta} = U_\theta \quad (12.84)$$

In the literature, these results are associated with the characteristic line. This analysis can be also applied to the same equation when they are normalized by Mach number. However, the non-dimensionalization can be applied at this stage as well.

The energy equation for any point on a stream line is

$$h(\theta) + \frac{U_\theta^2 + U_r^2}{2} = h_0 \quad (12.85)$$

Enthalpy in perfect gas with a constant specific heat,  $k$ , is

$$h(\theta) = C_p T = C_p \frac{R}{R} T = \frac{1}{(k-1)} \overbrace{\frac{C_p}{C_v}}^{c(\theta)^2} R T = \frac{c^2}{k-1} \quad (12.86)$$

and substituting this equality, equation (12.86), into equation (12.85) results in

$$\frac{c^2}{k-1} + \frac{U_\theta^2 + U_r^2}{2} = h_0 \quad (12.87)$$

Utilizing equation (12.82) for the speed of sound and substituting equation (12.84) which is the radial velocity transforms equation (12.87) into

$$\frac{\left(\frac{\partial U_r}{\partial \theta}\right)^2}{k-1} + \frac{\left(\frac{\partial U_r}{\partial \theta}\right)^2 + U_r^2}{2} = h_0 \quad (12.88)$$

After some rearrangement, equation (12.88) becomes

$$\frac{k+1}{k-1} \left(\frac{\partial U_r}{\partial \theta}\right)^2 + U_r^2 = 2h_0 \quad (12.89)$$

Note that  $U_r$  must be positive. The solution of the differential equation (12.89) incorporating the constant becomes

$$U_r = \sqrt{2h_0} \sin \left( \theta \sqrt{\frac{k-1}{k+1}} \right) \quad (12.90)$$

which satisfies equation (12.89) because  $\sin^2 \theta + \cos^2 \theta = 1$ . The arbitrary constant in equation (12.90) is chosen such that  $U_r(\theta = 0) = 0$ . The tangential velocity obtains the form

$$U_\theta = c = \frac{\partial U_r}{\partial \theta} = \sqrt{\frac{k-1}{k+1}} \sqrt{2h_0} \cos \left( \theta \sqrt{\frac{k-1}{k+1}} \right) \quad (12.91)$$

The Mach number in the turning area is

$$M^2 = \frac{U_\theta^2 + U_r^2}{c^2} = \frac{U_\theta^2 + U_r^2}{U_\theta^2} = 1 + \left(\frac{U_r}{U_\theta}\right)^2 \quad (12.92)$$

Now utilizing the expression that was obtained for  $U_r$  and  $U_\theta$  equations (12.91) and (12.90) results for the Mach number is

$$M^2 = 1 + \frac{k+1}{k-1} \tan^2 \left( \theta \sqrt{\frac{k-1}{k+1}} \right) \quad (12.93)$$

or the reverse function for  $\theta$  is

Reversed Angle

$$\theta = \sqrt{\frac{k+1}{k-1}} \tan^{-1} \left( \sqrt{\frac{k-1}{k+1}} (M^2 - 1) \right) \quad (12.94)$$

What happens when the upstream Mach number is not 1? That is when the initial condition for the turning angle doesn't start with  $M = 1$  but is already at a different angle. The upstream Mach number is denoted in this segment as  $M_{starting}$ . For this upstream Mach number (see Figure (12.22))

$$\tan \nu = \sqrt{M_{starting}^2 - 1} \quad (12.95)$$

The deflection angle  $\nu$ , has to match to the definition of the angle that is chosen here ( $\theta = 0$  when  $M = 1$ ), so

$$\nu(M) = \theta(M) - \theta(M_{starting}) \quad (12.96)$$

Deflection Angle

$$\nu(M) = \sqrt{\frac{k+1}{k-1}} \tan^{-1} \left( \sqrt{\frac{k-1}{k+1}} \sqrt{M^2 - 1} \right) - \tan^{-1} \sqrt{M^2 - 1} \quad (12.97)$$

These relationships are plotted in Figure (12.26).

### 12.3.4 Comparison And Limitations between the Two Approaches

The two models produce exactly the same results, but the assumptions for the construction of these models are different. In the geometrical model, the assumption is that the velocity change in the radial direction is zero. In the rigorous model, it was assumed that radial velocity is only a function of  $\theta$ . The statement for the construction of the geometrical model can be improved by assuming that the frame of reference is moving radially in a constant velocity.

Regardless of the assumptions that were used in the construction of these models, the fact remains that there is a radial velocity at  $U_r(r=0) = constant$ . At this point ( $r=0$ ) these models fail to satisfy the boundary conditions and something else happens there. On top of the complication of the turning point, the question of boundary layer arises. For example, how did the gas accelerate to above the speed of sound when

there is no nozzle (where is the nozzle?)? These questions are of interest in engineering but are beyond the scope of this book (at least at this stage). Normally, the author recommends that this function be used everywhere beyond 2-4 the thickness of the boundary layer based on the upstream length.

In fact, analysis of design commonly used in the industry and even questions posted to students show that many assume that the turning point can be sharp. At a small Mach number,  $(1 + \epsilon)$  the radial velocity is small  $\epsilon$ . However, an increase in the Mach number can result in a very significant radial velocity. The radial velocity is "fed" through the reduction of the density. Aside from its close proximity to turning point, mass balance is maintained by the reduction of the density. Thus, some researchers recommend that, in many instances, the sharp point should be replaced by a smoother transition.

### 12.4 The Maximum Turning Angle

The maximum turning angle is obtained when the starting Mach number is 1 and the end Mach number approaches infinity. In this case, Prandtl-Meyer function becomes

$$\nu_{\infty} = \frac{\pi}{2} \left[ \sqrt{\frac{k+1}{k-1}} - 1 \right] \quad (12.98)$$

The maximum of the deflection point and the maximum turning point are only a function of the specific heat ratios. However, the maximum turning angle is much larger than the maximum deflection point because the process is isentropic.

What happens when the deflection angle exceeds the maximum angle? The flow in this case behaves as if there is almost a maximum angle and in that region beyond the flow will become vortex street see Figure (12.25)

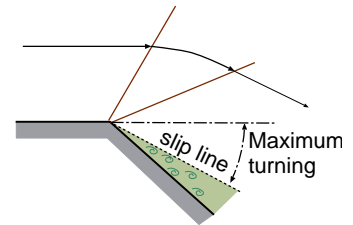

Fig. -12.25. Expansion of Prandtl-Meyer function when it exceeds the maximum angle.

### 12.5 The Working Equations for the Prandtl-Meyer Function

The change in the deflection angle is calculated by

$$\nu_2 - \nu_1 = \nu(M_2) - \nu(M_1) \quad (12.99)$$

### 12.6 d'Alembert's Paradox

### 12.7. FLAT BODY WITH AN ANGLE OF ATTACK

In ideal inviscid incompressible flows, the movement of body does not encounter any resistance. This result is known as d'Alembert's Paradox, and this paradox is examined here.

Supposed that a two-dimensional diamond-shaped body is stationed in a supersonic flow as shown in Figure (12.27). Again, it is assumed that the fluid is inviscid. The net force in flow direction, the drag, is

$$D = 2 \left( \frac{w}{2} (P_2 - P_4) \right) = w (P_2 - P_4) \quad (12.100)$$

It can be observed that only the area that "seems" to be by the flow was used in expressing equation (12.100). The relation between  $P_2$  and  $P_4$  is such that the flow depends on the upstream Mach number,  $M_1$ , and the specific heat,  $k$ . Regardless in the equation of the state of the gas, the pressure at zone 2,  $P_2$ , is larger than the pressure at zone 4,  $P_4$ . Thus, there is always drag when the flow is supersonic which depends on the upstream Mach number,  $M_1$ , specific heat,  $k$ , and the "visible" area of the object. This drag is known in the literature as (shock) wave drag.

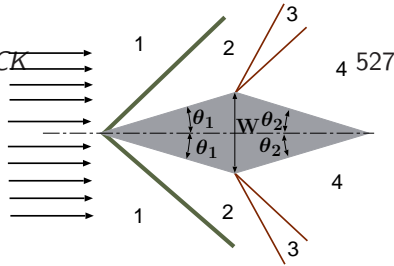

Fig. -12.27. A simplified diamond shape to illustrate the supersonic d'Alembert's Paradox.

### 12.7 Flat Body with an Angle of Attack

Previously, the thickness of a body was shown to have a drag. Now, a body with zero thickness but with an angle of attack will be examined. As opposed to the thickness of the body, in addition to the drag, the body also obtains lift. Again, the slip condition is such that the pressure in region 5 and 7 are the same, and additionally the direction of the velocity must be the same. As before, the magnitude of the velocity will be different between the two regions.

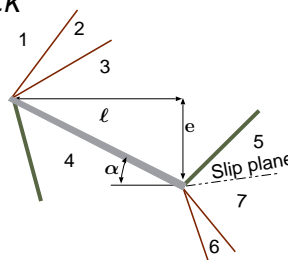

Fig. -12.28. The definition of attack angle for the Prandtl-Meyer function.

### 12.8 Examples For Prandtl-Meyer Function

**Example 12.16:**

A wall is included with  $20.0^\circ$  an inclination. A flow of air with a temperature of  $20^\circ\text{C}$  and a speed of  $U = 450\text{m/sec}$  flows (see Figure 12.29). Calculate the pressure reduction ratio, and the Mach number after the bending point. If the air flows in an imaginary two-dimensional tunnel with width of  $0.1\text{[m]}$  what will the width of this imaginary tunnel after the bend? Calculate the "fan" angle. Assume the specific heat ratio is  $k = 1.4$ .

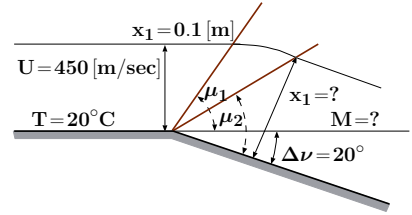

Fig. -12.29. Schematic for Example (12.5).

SOLUTION

First, the initial Mach number has to be calculated (the initial speed of sound).

$$a = \sqrt{kRT} = \sqrt{1.4 * 287 * 293} = 343.1\text{m/sec}$$

The Mach number is then

$$M = \frac{450}{343.1} = 1.31$$

this Mach number is associated with

M	$\nu$	$\frac{P}{P_0}$	$\frac{T}{T_0}$	$\frac{\rho}{\rho_0}$	$\mu$
1.3100	6.4449	0.35603	0.74448	0.47822	52.6434

The "new" angle should be

$$\nu_2 = 6.4449 + 20 = 26.4449^\circ$$

and results in

M	$\nu$	$\frac{P}{P_0}$	$\frac{T}{T_0}$	$\frac{\rho}{\rho_0}$	$\mu$
2.0024	26.4449	0.12734	0.55497	0.22944	63.4620

Note that  $P_{01} = P_{02}$

$$\frac{P_2}{P_1} = \frac{P_{01}}{P_1} \frac{P_2}{P_{02}} = \frac{0.12734}{0.35603} = 0.35766$$

The "new" width can be calculated from the mass conservation equation.

$$\rho_1 x_1 M_1 c_1 = \rho_2 x_2 M_2 c_2 \implies x_2 = x_1 \frac{\rho_1}{\rho_2} \frac{M_1}{M_2} \sqrt{\frac{T_1}{T_2}}$$

$$x_2 = 0.1 \times \frac{0.47822}{0.22944} \times \frac{1.31}{2.0024} \sqrt{\frac{0.74448}{0.55497}} = 0.1579[m]$$

Note that the compression “fan” stream lines are note and their function can be obtain either by numerical method of going over small angle increments. The other alternative is using the exact solution<sup>19</sup>. The expansion “fan” angle changes in the Mach angle between the two sides of the bend

$$\text{fan angle} = 63.4 + 20.0 - 52.6 = 30.8^\circ$$

End Solution

Reverse the example, and this time the pressure on both sides are given and the angle has to be obtained<sup>20</sup>.

**Example 12.17:**

Gas with  $k = 1.67$  flows over bend (see Figure 12.17). The gas flow with Mach 1.4 and Pressure 1.2[Bar]. It is given that the pressure after the turning is 1[Bar]. Compute the Mach number after the bend, and the bend angle.

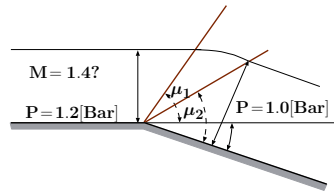

Fig. -12.30. Schematic for Example (12.5).

**SOLUTION**

The Mach number is determined by satisfying the condition that the pressure downstream and the Mach are given. The relative pressure downstream can be calculated by the relationship

$$\frac{P_2}{P_{02}} = \frac{P_2}{P_1} \frac{P_1}{P_{01}} = \frac{1}{1.2} \times 0.31424 = 0.2619$$

M	$\nu$	$\frac{P}{P_0}$	$\frac{T}{T_0}$	$\frac{\rho}{\rho_0}$	$\mu$
1.4000	7.7720	0.28418	0.60365	0.47077	54.4623

With this pressure ratio  $\bar{P} = 0.2619$  require either locking in the table or using the enclosed program.

M	$\nu$	$\frac{P}{P_0}$	$\frac{T}{T_0}$	$\frac{\rho}{\rho_0}$	$\mu$
1.4576	9.1719	0.26190	0.58419	0.44831	55.5479

<sup>19</sup>It isn't really different from this explanation but shown in a more mathematical form, due to Landau and friends. It will be presented in the future version. It isn't present now because of the low priority to this issue.

<sup>20</sup>This example is for academic understanding. There is very little with practicality in this kind of problem.

For the rest of the calculation the initial condition is used. The Mach number after the bend is  $M = 1.4576$ . It should be noted that specific heat isn't  $k = 1.4$  but  $k = 1.67$ . The bend angle is

$$\Delta\nu = 9.1719 - 7.7720 \sim 1.4^\circ$$

$$\Delta\mu = 55.5479 - 54.4623 = 1.0^\circ$$

---

End Solution

---

## 12.9 Combination of the Oblique Shock and Isentropic Expansion

**Example 12.18:**

Consider two-dimensional flat thin plate at an angle of attack of  $4^\circ$  and a Mach number of 3.3. Assume that the specific heat ratio at stage is  $k = 1.3$ , calculate the drag coefficient and lift coefficient.

SOLUTION

For  $M = 3.3$ , the following table can be obtained:

M	$\nu$	$\frac{P}{P_0}$	$\frac{T}{T_0}$	$\frac{\rho}{\rho_0}$	$\mu$
3.3000	62.3113	0.01506	0.37972	0.03965	73.1416

With the angle of attack the region 3 will be at  $\nu \sim 62.31 + 4$  for which the following table can be obtained (Potto-GDC)

M	$\nu$	$\frac{P}{P_0}$	$\frac{T}{T_0}$	$\frac{\rho}{\rho_0}$	$\mu$
3.4996	66.3100	0.01090	0.35248	0.03093	74.0528

On the other side, the oblique shock (assuming weak shock) results in

$M_x$	$M_{y_s}$	$M_{y_w}$	$\theta_s$	$\theta_w$	$\delta$	$\frac{P_{0y}}{P_{0x}}$
3.3000	0.43534	3.1115	88.9313	20.3467	4.0000	0.99676

and the additional information, by clicking on the minimal button, provides

$M_x$	$M_{y_w}$	$\theta_w$	$\delta$	$\frac{P_y}{P_x}$	$\frac{T_y}{T_x}$	$\frac{P_{0y}}{P_{0x}}$
3.3000	3.1115	20.3467	4.0000	1.1157	1.1066	0.99676



12.9. COMBINATION OF THE OBLIQUE SHOCK AND ISENTROPIC EXPANSION 531

The pressure ratio at point 3 is

$$\frac{P_3}{P_1} = \frac{P_3}{P_{03}} \frac{P_{03}}{P_{01}} \frac{P_{01}}{P_1} = 0.0109 \times 1 \times \frac{1}{0.01506} \sim 0.7238$$

The pressure ratio at point 4 is

$$\frac{P_3}{P_1} = 1.1157$$

$$d_L = \frac{2}{kP_1M_1^2} (P_4 - P_3) \cos \alpha = \frac{2}{kM_1^2} \left( \frac{P_4}{P_1} - \frac{P_3}{P_1} \right) \cos \alpha$$

$$d_L = \frac{2}{1.33.3^2} (1.1157 - 0.7238) \cos 4^\circ \sim .054$$

$$d_d = \frac{2}{kM_1^2} \left( \frac{P_4}{P_1} - \frac{P_3}{P_1} \right) \sin \alpha = \frac{2}{1.33.3^2} (1.1157 - 0.7238) \sin 4^\circ \sim .0039$$

This shows that on the expense of a small drag, a large lift can be obtained. Discussion on the optimum design is left for the next versions.

---

End Solution

---

**Example 12.19:**

To understand the flow after a nozzle consider a flow in a nozzle shown in Figure 12.19. The flow is choked and additionally the flow pressure reaches the nozzle exit above the surrounding pressure. Assume that there is an isentropic expansion (Prandtl–Meyer expansion) after the nozzle with slip lines in which there is a theoretical angle of expansion to match the surroundings pressure with the exit. The ratio of exit area to throat area ratio is 1:3. The stagnation pressure is 1000 [kPa]. The surroundings pressure is 100[kPa]. Assume that the specific heat,  $k = 1.3$ . Estimate the Mach number after the expansion.

SOLUTION

The Mach number at the nozzle exit can be calculated using Potto-GDC which provides

M	$\frac{T}{T_0}$	$\frac{\rho}{\rho_0}$	$\frac{A}{A^*}$	$\frac{P}{P_0}$	$\frac{A \times P}{A^* \times P_0}$	$\frac{F}{F^*}$
1.7632	0.61661	0.29855	1.4000	0.18409	0.25773	0.57478

Thus the exit Mach number is 1.7632 and the pressure at the exit is

$$P_{exit} = P_0 \frac{P - exit}{P - 0} = 1000 \times 0.18409 = 184.09[kPa]$$

This pressure is higher than the surroundings pressure and additional expansion must occur. This pressure ratio is associated with an expansion angle that Potto-GDC provide as

M	$\nu$	$\frac{P}{P_0}$	$\frac{T}{T_0}$	$\frac{\rho}{\rho_0}$	$\mu$
1.7632	19.6578	0.18409	0.61661	0.29855	60.4403

The need additional pressure ratio reduction is

$$\frac{P_{surroundings}}{P_0} = \frac{P_{surroundings}}{P_{exit}} \frac{P_{exit}}{P_0} = \frac{100}{184.09} \times 0.18409 = 0.1$$

Potto-GDC provides for this pressure ratio

M	$\nu$	$\frac{P}{P_0}$	$\frac{T}{T_0}$	$\frac{\rho}{\rho_0}$	$\mu$
2.1572	30.6147	0.10000	0.51795	0.19307	65.1292

The change of the angle is

$$\Delta \text{angle} = 30.6147 - 19.6578 = 10.9569$$

Thus the angle,  $\beta$  is

$$\beta = 90 - 10.9569 \sim 79.0$$

The pressure at this point is as the surroundings. However, the stagnation pressure is the same as originally was enter the nozzle! This stagnation pressure has to go through serious of oblique shocks and Prandtl-Meyer expansion to match the surroundings stagnation pressure.

### $\theta$ - $\delta$ -Mach number relationship

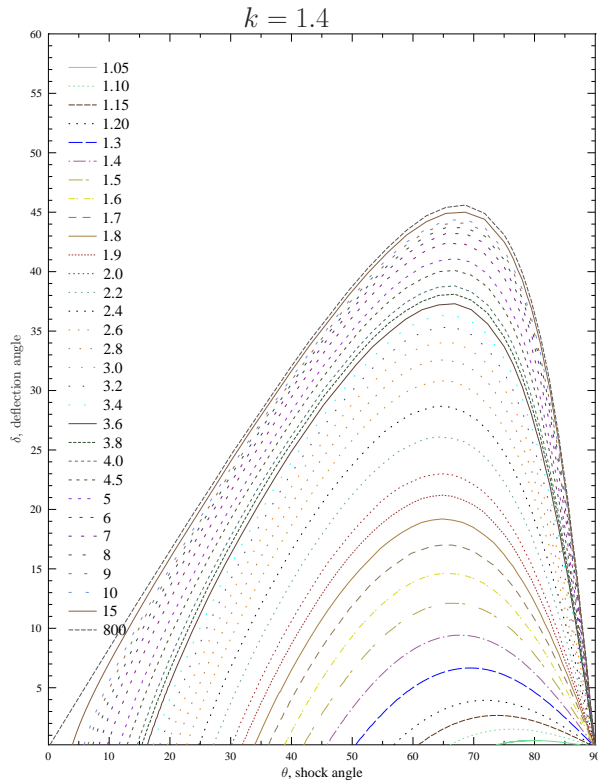

December 4, 2007

Fig. -12.20. The relationship between the shock wave angle,  $\theta$  and deflection angle,  $\delta$ , and Mach number for  $k=1.4$ . This figure was generate with GDC under command `./obliqueFigure 1.4`. Variety of these figures can be found in the biggest gas tables in the world provided separately in Potto Project.

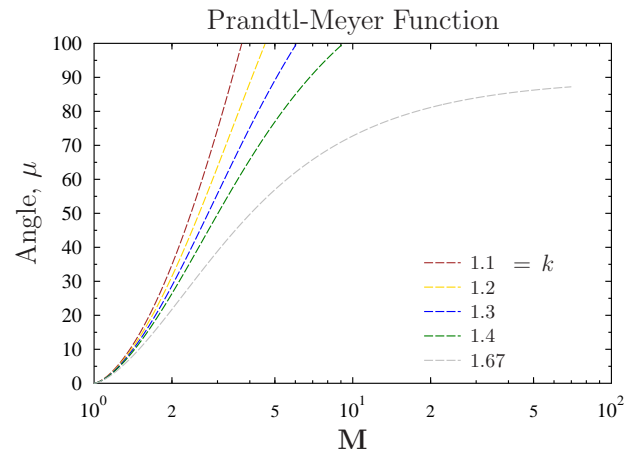

Fig. -12.26. The angle as a function of the Mach number and specific heat.

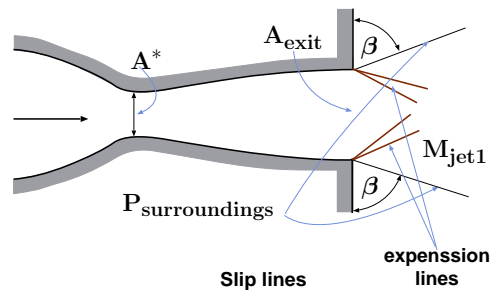

Fig. -12.31. Schematic of the nozzle and Prandtl-Meyer expansion.

---

---

# CHAPTER 13

---

## Multi-Phase Flow

### *13.1 Introduction*

Traditionally, the topic of multi-phase flow is ignored in an introductory class on fluid mechanics. For many engineers, this class will be the only opportunity to be exposed to this topic. The knowledge in this topic without any doubts, is required for many engineering problems. Calculations of many kinds of flow deals with more than one phase or material flow<sup>1</sup>. The author believes that the trends and effects of multiphase flow could and should be introduced and considered by engineers. In the past, books on multiphase flow were written more as a literature review or heavy on the mathematics. It is recognized that multiphase flow is still evolving. In fact, there is not a consensus to the exact map of many flow regimes. This book attempts to describe these issues as a fundamentals of physical aspects and less as a literature review. This chapter provides information that is more or less in consensus<sup>2</sup>. Additionally, the nature of multiphase flow requires solving many equations. Thus, in many books the representations is by writing the whole set governing equations. Here, it is believed that the interactions/calculations requires a full year class and hence, only the trends and simple calculations are described.

### *13.2 History*

The study of multi-phase flow started for practical purposes after World War II. Initially the models were using simple assumptions. For simple models, there are two possibilities (1) the fluids/materials are flowing in well homogeneous mixed (where the main problem

---

<sup>1</sup>An example, there was a Ph.D. working for the government who analyzed filing cavity with liquid metal (aluminum), who did not consider the flow as two-phase flow and ignoring the air. As result, his analysis is in the twilight zone not in the real world.

<sup>2</sup>Or when the scientific principles simply dictate.

to find the viscosity), (2) the fluids/materials are flowing separately where the actual total loss pressure can be correlated based on the separate pressure loss of each of the material. If the pressure loss was linear then the total loss will be the summation of the two pressure losses (of the lighter liquid (gas) and the heavy liquid). Under this assumption the total is not linear and experimental correlation was made. The flow patterns or regimes were not considered. This was suggested by Lockhart and Martinelli who use a model where the flow of the two fluids are independent of each other. They postulate that there is a relationship between the pressure loss of a single phase and combine phases pressure loss as a function of the pressure loss of the other phase. It turned out this idea provides a good crude results in some cases.

Researchers that followed Lockhart and Martinelli looked for a different map for different combination of phases. When it became apparent that specific models were needed for different situations, researchers started to look for different flow regimes and provided different models. Also the researchers looked at the situation when the different regimes are applicable. Which leads to the concept of flow regime maps. Taitle and Duckler suggested a map based on five non-dimensional groups which are considered as the most useful today. However, Taitle and Duckler's map is not universal and it is only applied to certain liquid-gas conditions. For example, Taitle-Duckler's map is not applicable for microgravity.

### *13.3 What to Expect From This Chapter*

As oppose to the tradition of the other chapters in this book and all other Potto project books, a description of what to expect in this chapter is provided. It is an attempt to explain and convince all the readers that the multi-phase flow must be included in introductory class on fluid mechanics<sup>3</sup>. Hence, this chapter will explain the core concepts of the multiphase flow and their relationship, and importance to real world.

This chapter will provide: a category of combination of phases, the concept of flow regimes, multi-phase flow parameters definitions, flow parameters effects on the flow regimes, partial discussion on speed of sound of different regimes, double choking phenomenon (hopefully), and calculation of pressure drop of simple homogeneous model. This chapter will introduce these concepts so that the engineer not only be able to understand a conversation on multi-phase but also, and more importantly, will know and understand the trends. However, this chapter will not provide a discussion of transient problems, phase change or transfer processes during flow, and actual calculation of pressure of the different regimes.

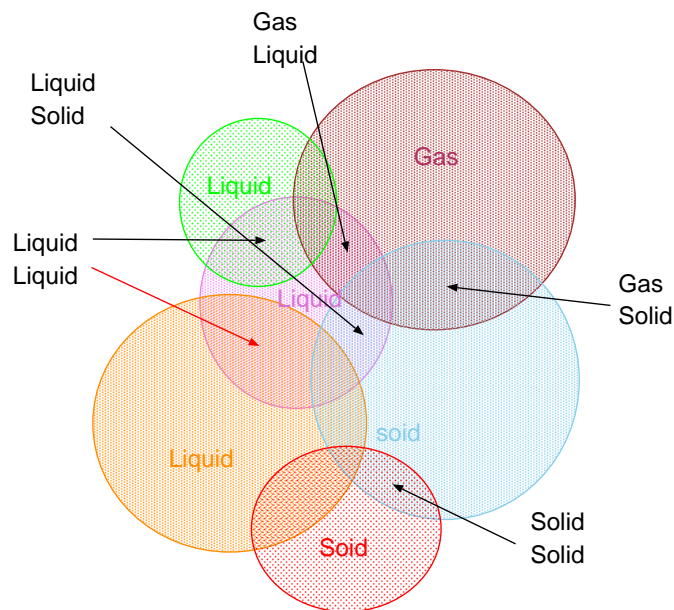

Fig. -13.1. Different fields of multi phase flow.

### 13.4 Kind of Multi-Phase Flow

All the flows are a form of multiphase flow. The discussion in the previous chapters is only as approximation when multiphase can be “reduced” into a single phase flow. For example, consider air flow that was discussed and presented earlier as a single phase flow. Air is not a pure material but a mixture of many gases. In fact, many properties of air are calculated as if the air is made of well mixed gases of Nitrogen and Oxygen. The results of the calculations of a mixture do not change much if it is assumed that the air flow as stratified flow<sup>4</sup> of many concentration layers (thus, many layers (infinite) of different materials). Practically for many cases, the homogeneous assumption is enough and suitable. However, this assumption will not be appropriate when the air is stratified because of large body forces, or a large acceleration. Adopting this assumption might lead to a larger error. Hence, there are situations when air flow has to be considered as multiphase flow and this effect has to be taken into account.

In our calculation, it is assumed that air is made of only gases. The creation

<sup>3</sup>This author feels that he is in a unique position to influence many in the field of fluid mechanics. This fact is due to the sheer number of the downloaded Potto books. The number of the downloads of the book on Fundamental of compressible flow has exceed more than 100,000 in about two and half years. It also provides an opportunity to bring the latest advances in the fields since this author does not need to “sell” the book to a publisher or convince a “committee.”

<sup>4</sup>Different concentration of oxygen as a function of the height. While the difference of the concentration between the top to bottom is insignificant, nonetheless it exists.

of clean room is a proof that air contains small particles. In almost all situations, the cleanness of the air or the fact that air is a mixture is ignored. The engineering accuracy is enough to totally ignore it. Yet, there are situations where cleanness of the air can affect the flow. For example, the cleanness of air can reduce the speed of sound. In the past, the breaks in long trains were activated by reduction of the compressed line (a patent no. 360070 issued to George Westinghouse, Jr., March 29, 1887). In a four (4) miles long train, the breaks would started to work after about 20 seconds in the last wagon. Thus, a 10% change of the speed of sound due to dust particles in air could reduce the stopping time by 2 seconds (50 meter difference in stopping) and can cause an accident.

One way to categorize the multiphase is by the materials flows, For example, the flow of oil and water in one pipe is a multiphase flow. This flow is used by engineers to reduce the cost of moving crude oil through a long pipes system. The “average” viscosity is meaningless since in many cases the water follows around the oil. The water flow is the source of the friction. However, it is more common to categorize the flow by the distinct phases that flow in the tube. Since there are three phases, they can be solid–liquid, solid–gas, liquid–gas and solid–liquid–gas flow. This notion eliminates many other flow categories that can and should be included in multiphase flow. This category should include any distinction of phase/material. There are many more categories, for example, sand and grain (which are “solids”) flow with rocks and is referred to solid–solid flow. The category of liquid–gas should be really viewed as the extreme case of liquid-liquid where the density ratio is extremely large. The same can be said for gas–gas flow. For the gas, the density is a strong function of the temperature and pressure. Open Channel flow is, although important, is only an extreme case of liquid-gas flow and is a sub category of the multiphase flow.

The multiphase is an important part of many processes. The multiphase can be found in nature, living bodies (bio–fluids), and industries. Gas–solid can be found in sand storms, and avalanches. The body inhales solid particle with breathing air. Many industries are involved with this flow category such as dust collection, fluidized bed, solid propellant rocket, paint spray, spray casting, plasma and river flow with live creatures (small organisms to large fish) flow of ice berg, mud flow etc. The liquid–solid, in nature can be blood flow, and river flow. This flow also appears in any industrial process that are involved in solidification (for example die casting) and in moving solid particles. Liquid–liquid flow is probably the most common flow in the nature. Flow of air is actually the flow of several light liquids (gases). Many natural phenomenon are multiphase flow, for an example, rain. Many industrial process also include liquid-liquid such as painting, hydraulic with two or more kind of liquids.

### *13.5 Classification of Liquid-Liquid Flow Regimes*

The general discussion on liquid–liquid will be provided and the gas–liquid flow will be discussed as a special case. Generally, there are two possibilities for two different materials to flow (it is also correct for solid–liquid and any other combination). The materials can flow in the same direction and it is referred as co–current flow. When the



materials flow in the opposite direction, it is referred as counter-current. In general, the co-current is the more common. Additionally, the counter-current flow must have special configurations of long length of flow. Generally, the counter-current flow has a limited length window of possibility in a vertical flow in conduits with the exception of magnetohydrodynamics. The flow regimes are referred to the arrangement of the fluids.

The main difference between the liquid-liquid flow to gas-liquid flow is that gas density is extremely lighter than the liquid density. For example, water and air flow as oppose to water and oil flow. The other characteristic that is different between the gas flow and the liquid flow is the variation of the density. For example, a reduction of the pressure by half will double the gas volumetric flow rate while the change in the liquid is negligible. Thus, the flow of gas-liquid can have several flow regimes in one situation while the flow of liquid-liquid will (probably) have only one flow regime.

### 13.5.1 Co-Current Flow

In Co-Current flow, two liquids can have three main categories: vertical, horizontal, and what ever between them. The vertical configuration has two cases, up or down. It is common to differentiate between the vertical (and near vertical) and horizontal (and near horizontal). There is no exact meaning to the word "near vertical" or "near horizontal" and there is no consensus on the limiting angles (not to mention to have limits as a function with any parameter that determine the limiting angle). The flow in inclined angle (that not covered by the word "near") exhibits flow regimes not much different from the other two. Yet, the limits between the flow regimes are considerably different. This issue of incline flow will not be covered in this chapter.

#### 13.5.1.1 Horizontal Flow

The typical regimes for horizontal flow are stratified flow (open channel flow, and non open channel flow), dispersed bubble flow, plug flow, and annular flow.

For low velocity (low flow rate) of the two liquids, the heavy liquid flows on the bottom and lighter liquid flows on the top<sup>5</sup> as depicted in Figure 13.2. This

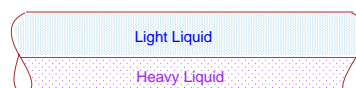

Fig. -13.2. Stratified flow in horizontal tubes when the liquids flow is very slow.

kind of flow regime is referred to as horizontal flow. When the flow rate of the lighter liquid is almost zero, the flow is referred to as open channel flow. This definition (open channel flow) continues for small amount of lighter liquid as long as the heavier flow can be calculated as open channel flow (ignoring the lighter liquid). The geometries (even the boundaries) of open channel flow are very diverse. Open channel flow appears in many nature (river) as well in industrial process such as the die casting process where liquid metal is injected into a cylinder (tube) shape. The channel flow will be discussed in a greater detail in Open Channel Flow chapter.

<sup>5</sup>With the exception of the extremely smaller diameter where Rayleigh-Taylor instability is an important issue.

As the lighter liquid (or the gas phase) flow rate increases (superficial velocity), the friction between the phases increase. The superficial velocity is referred to as the velocity that any phase will have if the other phase was not exist. This friction is one of the cause for the instability which manifested itself as waves and changing the surface from straight line to a different configuration (see Figure 13.3). The wave shape is created to keep the gas and the liquid velocity equal and at the same time to have shear stress to be balance by surface tension. The configuration of the cross section not only depend on the surface tension, and other physical properties of the fluids but also on the material of the conduit.

As the lighter liquid velocity increases two things can happen (1) wave size increase and (2) the shape of cross section continue to deform. Some referred to this regime as wavy stratified flow but this definition is not accepted by all as a category by itself. In fact, all the two phase flow are categorized by wavy flow which will proven later. There are two paths that can occur on the heavier liquid flow rate. If the heavier flow rate is small,

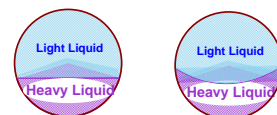

Fig. -13.3. Kind of Stratified flow in horizontal tubes.

then the wave cannot reach to the crown and the shape is deformed to the point that all the heavier liquid is around the periphery. This kind of flow regime is referred to as annular flow. If the heavier liquid flow rate is larger<sup>6</sup> than the distance, for the wave to reach the conduit crown is smaller. At some point, when the lighter liquid flow increases, the heavier liquid wave reaches to the crown of the pipe. At this stage, the flow pattern is referred to as slug flow or plug flow. Plug flow is characterized by regions of lighter liquid filled with drops of the heavier liquid with Plug (or Slug) of the heavier liquid (with bubble of the lighter liquid). These plugs are separated by large “chunks” that almost fill the entire tube. The plugs are flowing in a succession (see Figure 13.4). The pressure drop of this kind of regime is significantly larger than the stratified flow. The slug flow cannot be assumed to be as homogeneous flow nor it can exhibit some average viscosity. The “average” viscosity depends on the flow and thus making it as insignificant way to do the calculations. Further increase of the lighter liquid flow rate move the flow regime into annular flow. Thus, the possibility to go through slug flow regime depends on if there is enough liquid flow rate.

Choking occurs in compressible flow when the flow rate is above a certain point. All liquids are compressible to some degree. For liquid which the density is a strong and primary function of the pressure, choking occurs relatively closer/sooner. Thus, the flow that starts as a stratified flow will turned into a slug flow or stratified wavy<sup>7</sup> flow after a certain distance depends on the heavy flow rate (if

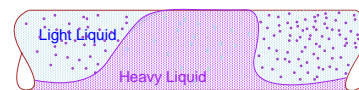

Fig. -13.4. Plug flow in horizontal tubes when the liquids flow is faster.

<sup>6</sup>The liquid level is higher.

<sup>7</sup>Well, all the flow is wavy, thus it is arbitrary definition.

this category is accepted). After a certain distance, the flow become annular or the flow will choke. The choking can occur before the annular flow regime is obtained depending on the velocity and compressibility of the lighter liquid. Hence, as in compressible flow, liquid-liquid flow has a maximum combined of the flow rate (both phases). This maximum is known as double choking phenomenon.

The reverse way is referred to the process where the starting point is high flow rate and the flow rate is decreasing. As in many fluid mechanics and magnetic fields, the return path is not move the exact same way. There is even a possibility to return on different flow regime. For example, flow that had slug flow in its path can be returned as stratified wavy flow. This phenomenon is refer to as hysteresis.

Flow that is under small angle from the horizontal will be similar to the horizontal flow. However, there is no consensus how far is the “near” means. Qualitatively, the “near” angle depends on the length of the pipe. The angle decreases with the length of the pipe. Besides the length, other parameters can affect the “near.”

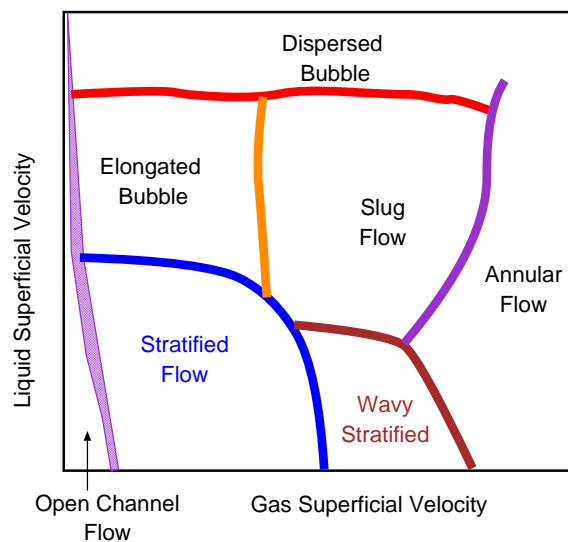

Fig. -13.5. Modified Mandhane map for flow regime in horizontal tubes.

The results of the above discussion are depicted in Figure 13.5. As many things in multiphase, this map is only characteristics of the “normal” conditions, e.g. in normal gravitation, weak to strong surface tension effects (air/water in “normal” gravity), etc.

### 13.5.1.2 Vertical Flow

The vertical flow has two possibilities, with the gravity or against it. In engineering application, the vertical flow against the gravity is more common used. There is a difference between flowing with the gravity and flowing against the gravity. The buoyancy

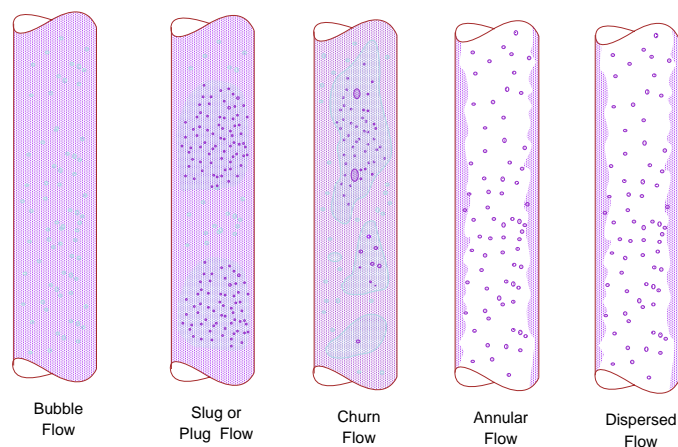

Fig. -13.6. Gas and liquid in Flow in vertical tube against the gravity.

is acting in two different directions for these two flow regimes. For the flow against gravity, the lighter liquid has a buoyancy that acts as an “extra force” to move it faster and this effect is opposite for the heavier liquid. The opposite is for the flow with gravity. Thus, there are different flow regimes for these two situations. The main reason that causes the difference is that the heavier liquid is more dominated by gravity (body forces) while the lighter liquid is dominated by the pressure driving forces.

### Flow Against Gravity

For vertical flow against gravity, the flow cannot start as a stratified flow. The heavier liquid has to occupy almost the entire cross section before it can flow because of the gravity forces. Thus, the flow starts as a bubble flow. The increase of the lighter liquid flow rate will increase the number of bubbles until some bubbles start to collide. When many bubbles collide, they create a large bubble and the flow is referred to as slug flow or plug flow (see Figure 13.6). Notice, the different mechanism in creating the plug flow in horizontal flow compared to the vertical flow.

Further increase of lighter liquid flow rate will increase the slug size as more bubbles collide to create “super slug”; the flow regime is referred as elongated bubble flow. The flow is less stable as more turbulent flow and several “super slug” or churn flow appears in more chaotic way, see Figure 13.6. After additional increase of “super slug”, all these “elongated slug” unite to become an annular flow. Again, it can be noted the difference in the mechanism that create annular flow for vertical and horizontal flow. Any further increase transforms the outer liquid layer into bubbles in the inner liquid. Flow of near vertical against the gravity in two-phase does not deviate from vertical. The choking can occur at any point depends on the fluids and temperature and pressure.

### 13.5.1.3 Vertical Flow Under Micro Gravity

The above discussion mostly explained the flow in a vertical configuration when the surface tension can be neglected. In cases where the surface tension is very important. For example, out in space between gas and liquid (large density difference) the situation is different. The flow starts as dispersed bubble (some call it as “gas continuous”) because the gas phase occupies most of column. The liquid flows through a trickle or channeled flow that only partially wets part of the tube. The interaction between the phases is minimal and can be considered as the “open channel flow” of the vertical configuration. As the gas flow increases, the liquid becomes more turbulent and some parts enter into the gas phase as drops. When the flow rate of the gas increases further, all the gas phase change into tiny drops of liquid and this kind of regime referred to as mist flow. At a higher rate of liquid flow and a low flow rate of gas, the regime liquid fills the entire void and the gas is in small bubble and this flow referred to as bubbly flow. In the medium range of the flow rate of gas and liquid, there is pulse flow in which liquid is moving in frequent pulses. The common map is based on dimensionless parameters. Here, it is presented in a dimension form to explain the trends (see Figure 13.7). In the literature, Figure 13.7 presented in dimensionless coordinates. The abscissa is a function of combination of Froude, Reynolds, and Weber numbers. The ordinate is a combination of flow rate ratio and density ratio.

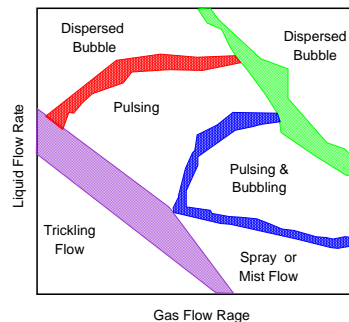

Fig. -13.7. A dimensional vertical flow map under very low gravity against the gravity.

### Flow With The Gravity

As opposed to the flow against gravity, this flow can start with stratified flow. A good example for this flow regime is a water fall. The initial part for this flow is more significant. Since the heavy liquid can be supplied from the “wrong” point/side, the initial part has a larger section compared to the flow against the gravity flow. After the flow has settled, the flow continues in a stratified configuration. The transitions between the flow regimes is similar to stratified flow. However, the points where these transitions occur are different from the horizontal flow. While this author is not aware of an actual model, it must be possible to construct a model that connects this configuration with the stratified flow where the transitions will be dependent on the angle of inclinations.

## 13.6 Multi-Phase Flow Variables Definitions

Since the gas-liquid system is a specific case of the liquid-liquid system, both will be united in this discussion. However, for the convenience of the terms “gas and liquid” will be used to signify the lighter and heavier liquid, respectively. The liquid-liquid (also

gas–liquid) flow is an extremely complex three–dimensional transient problem since the flow conditions in a pipe may vary along its length, over its cross section, and with time. To simplify the descriptions of the problem and yet to retain the important features of the flow, some variables are defined so that the flow can be described as a one-dimensional flow. This method is the most common and important to analyze two-phase flow pressure drop and other parameters. Perhaps, the only serious missing point in this discussion is the change of the flow along the distance of the tube.

### 13.6.1 Multi–Phase Averaged Variables Definitions

The total mass flow rate through the tube is the sum of the mass flow rates of the two phases

$$\dot{m} = \dot{m}_G + \dot{m}_L \quad (13.1)$$

It is common to define the mass velocity instead of the regular velocity because the “regular” velocity changes along the length of the pipe. The gas mass velocity is

$$G_G = \frac{\dot{m}_G}{A} \quad (13.2)$$

Where  $A$  is the entire area of the tube. It has to be noted that this mass velocity does not exist in reality. The liquid mass velocity is

$$G_L = \frac{\dot{m}_L}{A} \quad (13.3)$$

The mass flow of the tube is then

$$G = \frac{\dot{m}}{A} \quad (13.4)$$

It has to be emphasized that this mass velocity is the actual velocity.

The volumetric flow rate is not constant (since the density is not constant) along the flow rate and it is defined as

$$Q_G = \frac{G_G}{\rho_G} = U_{sG} \quad (13.5)$$

and for the liquid

$$Q_L = \frac{G_L}{\rho_L} \quad (13.6)$$

For liquid with very high bulk modulus (almost constant density), the volumetric flow rate can be considered as constant. The total volumetric volume vary along the tube length and is

$$Q = Q_L + Q_G \quad (13.7)$$

Ratio of the gas flow rate to the total flow rate is called the 'quality' or the "dryness fraction" and is given by

$$X = \frac{\dot{m}_G}{\dot{m}} = \frac{G_G}{G} \quad (13.8)$$

In a similar fashion, the value of  $(1 - X)$  is referred to as the "wetness fraction." The last two fractions remain constant along the tube length as long the gas and liquid masses remain constant. The ratio of the gas flow cross sectional area to the total cross sectional area is referred as the void fraction and defined as

$$\alpha = \frac{A_G}{A} \quad (13.9)$$

This fraction is vary along tube length since the gas density is not constant along the tube length. The liquid fraction or liquid holdup is

$$L_H = 1 - \alpha = \frac{A_L}{A} \quad (13.10)$$

It must be noted that Liquid holdup,  $L_H$  is not constant for the same reasons the void fraction is not constant.

The actual velocities depend on the other phase since the actual cross section the phase flows is dependent on the other phase. Thus, a superficial velocity is commonly defined in which if only one phase is using the entire tube. The gas superficial velocity is therefore defined as

$$U_{sG} = \frac{G_G}{\rho_G} = \frac{X \dot{m}}{\rho_G A} = Q_G \quad (13.11)$$

The liquid superficial velocity is

$$U_{sL} = \frac{G_L}{\rho_L} = \frac{(1 - X) \dot{m}}{\rho_L A} = Q_L \quad (13.12)$$

Since  $U_{sL} = Q_L$  and similarly for the gas then

$$U_m = U_{sG} + U_{sL} \quad (13.13)$$

Where  $U_m$  is the averaged velocity. It can be noticed that  $U_m$  is not constant along the tube.

The average superficial velocity of the gas and liquid are different. Thus, the ratio of these velocities is referred to as the slip velocity and is defined as the following

$$SLP = \frac{U_G}{U_L} \quad (13.14)$$

Slip ratio is usually greater than unity. Also, it can be noted that the slip velocity is not constant along the tube.

For the same velocity of phases ( $SLP = 1$ ), the mixture density is defined as

$$\rho_m = \alpha \rho_G + (1 - \alpha) \rho_L \quad (13.15)$$

This density represents the density taken at the “frozen” cross section (assume the volume is the cross section times infinitesimal thickness of  $dx$ ).

The average density of the material flowing in the tube can be evaluated by looking at the definition of density. The density of any material is defined as  $\rho = m/V$  and thus, for the flowing material it is

$$\rho = \frac{\dot{m}}{Q} \quad (13.16)$$

Where  $Q$  is the volumetric flow rate. Substituting equations (13.1) and (13.7) into equation (13.16) results in

$$\rho_{average} = \frac{\overbrace{X \dot{m}_G + (1-X) \dot{m}_L}^{\dot{m}_G + \dot{m}_L}}{Q_G + Q_L} = \frac{X \dot{m}_G + (1-X) \dot{m}_L}{\underbrace{X \dot{m}_G}_{\frac{\rho_G}{Q_G}} + \underbrace{(1-X) \dot{m}_L}_{\frac{\rho_L}{Q_L}}} \quad (13.17)$$

Equation (13.17) can be simplified by canceling the  $\dot{m}$  and noticing the  $(1-X) + X = 1$  to become

$$\rho_{average} = \frac{1}{\frac{X}{\rho_G} + \frac{(1-X)}{\rho_L}} \quad (13.18)$$

The average specific volume of the flow is then

$$v_{average} = \frac{1}{\rho_{average}} = \frac{X}{\rho_G} + \frac{(1-X)}{\rho_L} = X v_G + (1-X) v_L \quad (13.19)$$

The relationship between  $X$  and  $\alpha$  is

$$X = \frac{\dot{m}_G}{\dot{m}_G + \dot{m}_L} = \frac{\rho_G U_G \overbrace{A \alpha}^{A_G}}{\underbrace{\rho_L U_L A(1-\alpha)}_{A_L} + \rho_G U_G A \alpha} = \frac{\rho_G U_G \alpha}{\rho_L U_L (1-\alpha) + \rho_G U_G \alpha} \quad (13.20)$$

If the slip is one  $SLP = 1$ , thus equation (13.20) becomes

$$X = \frac{\rho_G \alpha}{\rho_L (1-\alpha) + \rho_G \alpha} \quad (13.21)$$



### 13.7 Homogeneous Models

Before discussing the homogeneous models, it is worthwhile to appreciate the complexity of the flow. For the construction of fluid basic equations, it was assumed that the flow is continuous. Now, this assumption has to be broken, and the flow is continuous only in many chunks (small segments). Furthermore, these segments are not defined but results of the conditions imposed on the flow. In fact, the different flow regimes are examples of typical configuration of segments of continuous flow. Initially, it was assumed that the different flow regimes can be neglected at least for the pressure loss (not correct for the heat transfer). The single phase was studied earlier in this book and there is a considerable amount of information about it. Thus, the simplest is to use it for approximation.

The average velocity (see also equation (13.13)) is

$$U_m = \frac{Q_L + Q_G}{A} = U_{sL} + U_{sG} = U_m \quad (13.22)$$

It can be noted that the continuity equation is satisfied as

$$\dot{m} = \rho_m U_m A \quad (13.23)$$

**Example 13.1:**

*Under what conditions equation (13.23) is correct?*

SOLUTION

Under construction

---

End Solution

The governing momentum equation can be approximated as

$$\dot{m} \frac{dU_m}{dx} = -A \frac{dP}{dx} - S \tau_w - A \rho_m g \sin \theta \quad (13.24)$$

or modifying equation (13.24) as

$$-\frac{dP}{dx} = -\frac{S}{A} \tau_w - \frac{\dot{m}}{A} \frac{dU_m}{dx} + \rho_m g \sin \theta \quad (13.25)$$

The energy equation can be approximated as

$$\frac{dq}{dx} - \frac{dw}{dx} = \dot{m} \frac{d}{dx} \left( h_m + \frac{U_m^2}{2} + g x \sin \theta \right) \quad (13.26)$$

### 13.7.1 Pressure Loss Components

In a tube flowing upward in incline angle  $\theta$ , the pressure loss is affected by friction loss, acceleration, and body force (gravitation). These losses are non-linear and depend on each other. For example, the gravitation pressure loss reduce the pressure and thus the density must change and hence, acceleration must occur. However, for small distances ( $dx$ ) and some situations, this dependency can be neglected. In that case, from equation (13.25), the total pressure loss can be written as

$$\frac{dP}{dx} = \overbrace{\left. \frac{dP}{dx} \right|_f}^{\text{friction}} + \overbrace{\left. \frac{dP}{dx} \right|_a}^{\text{acceleration}} + \overbrace{\left. \frac{dP}{dx} \right|_g}^{\text{gravity}} \quad (13.27)$$

Every part of the total pressure loss will be discussed in the following section.

#### 13.7.1.1 Friction Pressure Loss

The frictional pressure loss for a conduit can be calculated as

$$-\left. \frac{dP}{dx} \right|_f = \frac{S}{A} \tau_w \quad (13.28)$$

Where  $S$  is the perimeter of the fluid. For calculating the frictional pressure loss in the pipe is

$$-\left. \frac{dP}{dx} \right|_f = \frac{4 \tau_w}{D} \quad (13.29)$$

The wall shear stress can be estimated by

$$\tau_w = f \frac{\rho_m U_m^2}{2} \quad (13.30)$$

The friction factor is measured for a single phase flow where the average velocity is directly related to the wall shear stress. There is not available experimental data for the relationship of the averaged velocity of the two (or more) phases and wall shear stress. In fact, this friction factor was not measured for the “averaged” viscosity of the two phase flow. Yet, since there isn’t anything better, the experimental data that was developed and measured for single flow is used.

The friction factor is obtained by using the correlation

$$f = C \left( \frac{\rho_m U_m D}{\mu_m} \right)^{-n} \quad (13.31)$$

Where  $C$  and  $n$  are constants which depend on the flow regimes (turbulent or laminar flow). For laminar flow  $C = 16$  and  $n = 1$ . For turbulent flow  $C = 0.079$  and  $n = 0.25$ .

There are several suggestions for the average viscosity. For example, Duckler suggest the following

$$\mu_m = \frac{\mu_G Q_G}{Q_G + Q_L} + \frac{\mu_L Q_L}{Q_G + Q_L} \quad (13.32)$$

Duckler linear formula does not provide always good approximation and Cichilli suggest similar to equation (13.18) average viscosity as

$$\mu_{average} = \frac{1}{\frac{X}{\mu_G} + \frac{(1-X)}{\mu_L}} \quad (13.33)$$

Or simply make the average viscosity depends on the mass fraction as

$$\mu_m = X \mu_G + (1 - X) \mu_L \quad (13.34)$$

Using this formula, the friction loss can be estimated.

### 13.7.1.2 Acceleration Pressure Loss

The acceleration pressure loss can be estimated by

$$-\left. \frac{dP}{dx} \right|_a = \dot{m} \frac{dU_m}{dx} \quad (13.35)$$

The acceleration pressure loss (can be positive or negative) results from change of density and the change of cross section. Equation (13.35) can be written as

$$-\left. \frac{dP}{dx} \right|_a = \dot{m} \frac{d}{dx} \left( \frac{\dot{m}}{A \rho_m} \right) \quad (13.36)$$

Or in an explicit way equation (13.36) becomes

$$-\left. \frac{dP}{dx} \right|_a = \dot{m}^2 \left[ \underbrace{\frac{1}{A} \frac{d}{dx} \left( \frac{1}{\rho_m} \right)}_{\text{pressure loss due to density change}} + \underbrace{\frac{1}{\rho_m A^2} \frac{dA}{dx}}_{\text{pressure loss due to area change}} \right] \quad (13.37)$$

There are several special cases. The first case where the cross section is constant,  $dA/dx = 0$ . In second case is where the mass flow rates of gas and liquid is constant in which the derivative of  $X$  is zero,  $dX/dx = 0$ . The third special case is for constant density of one phase only,  $d\rho_L/dx = 0$ . For the last point, the private case is where densities are constant for both phases.

### 13.7.1.3 Gravity Pressure Loss

Gravity was discussed in Chapter 4 and is

$$\left. \frac{dP}{dx} \right|_g = g \rho_m \sin \theta \quad (13.38)$$

The density change during the flow can be represented as a function of density. The density in equation (13.38) is the density without the “movement” (the “static” density).

### 13.7.1.4 Total Pressure Loss

The total pressure between two points, ( $a$  and  $b$ ) can be calculated with integration as

$$\Delta P_{ab} = \int_a^b \frac{dP}{dx} dx \quad (13.39)$$

and therefore

$$\Delta P_{ab} = \overbrace{\Delta P_{abf}}^{\text{friction}} + \overbrace{\Delta P_{aba}}^{\text{acceleration}} + \overbrace{\Delta P_{abg}}^{\text{gravity}} \quad (13.40)$$

## 13.7.2 Lockhart Martinelli Model

The second method is by assumption that every phase flow separately. One such popular model by Lockhart and Martinelli<sup>8</sup>. Lockhart and Martinelli built model based on the assumption that the separated pressure loss are independent from each other. Lockhart Martinelli parameters are defined as the ratio of the pressure loss of two phases and pressure of a single phase. Thus, there are two parameters as shown below.

$$\phi_G = \sqrt{\left. \frac{dP}{dx} \right|_{TP} / \left. \frac{dP}{dx} \right|_{SG}} \Big|_f \quad (13.41)$$

Where the  $TP$  denotes the two phases and  $SG$  denotes the pressure loss for the single gas phase. Equivalent definition for the liquid side is

$$\phi_L = \sqrt{\left. \frac{dP}{dx} \right|_{TP} / \left. \frac{dP}{dx} \right|_{SL}} \Big|_f \quad (13.42)$$

Where the  $SL$  denotes the pressure loss for the single liquid phase.

The ratio of the pressure loss for a single liquid phase and the pressure loss for a single gas phase is

$$\Xi = \sqrt{\left. \frac{dP}{dx} \right|_{SL} / \left. \frac{dP}{dx} \right|_{SG}} \Big|_f \quad (13.43)$$

<sup>8</sup>This method was considered a military secret, private communication with Y., Taitle

where  $\Xi$  is Martinelli parameter.

It is assumed that the pressure loss for both phases are equal.

$$\left. \frac{dP}{dx} \right|_{SG} = \left. \frac{dP}{dx} \right|_{SL} \quad (13.44)$$

The pressure loss for the liquid phase is

$$\left. \frac{dP}{dx} \right|_L = \frac{2 f_L U_L^2 \rho_l}{D_L} \quad (13.45)$$

For the gas phase, the pressure loss is

$$\left. \frac{dP}{dx} \right|_G = \frac{2 f_G U_G^2 \rho_l}{D_G} \quad (13.46)$$

Simplified model is when there is no interaction between the two phases.

To insert the Diagram.

### 13.8 Solid-Liquid Flow

Solid-liquid system is simpler to analyze than the liquid-liquid system. In solid-liquid, the effect of the surface tension are very minimal and can be ignored. Thus, in this discussion, it is assumed that the surface tension is insignificant compared to the gravity forces. The word "solid" is not really mean solid but a combination of many solid particles. Different combination of solid particle creates different "liquid." Therefore, there will be a discussion about different particle size and different geometry (round, cubic, etc). The uniformity is categorizing the particle sizes, distribution, and geometry. For example, analysis of small coal particles in water is different from large coal particles in water.

The density of the solid can be above or below the liquid. Consider the case where the solid is heavier than the liquid phase. It is also assumed that the "liquids" density does not change significantly and it is far from the choking point. In that case there are four possibilities for vertical flow:

1. The flow with the gravity and lighter density solid particles.
2. The flow with the gravity and heavier density solid particles.
3. The flow against the gravity and lighter density solid particles.
4. The flow against the gravity and heavier density solid particles.

All these possibilities are different. However, there are two sets of similar characteristics, possibility, 1 and 4 and the second set is 2 and 3. The first set is similar because the solid particles are moving faster than the liquid velocity and vice versa for the second set (slower than the liquid). The discussion here is about the last case (4) because very little is known about the other cases.

### 13.8.1 Solid Particles with Heavier Density $\rho_S > \rho_L$

Solid-liquid flow has several combination flow regimes.

When the liquid velocity is very small, the liquid cannot carry the solid particles because there is not enough resistance to lift up the solid particles. A particle in a middle of the vertical liquid flow experience several forces. The force balance of spherical particle in field viscous fluid (creeping flow) is

$$\underbrace{\frac{\pi D^3 g (\rho_S - \rho_L)}{6}}_{\text{gravity and buoyancy forces}} = \underbrace{\frac{C_{D\infty} \pi D^2 \rho_L U_L^2}{8}}_{\text{drag forces}} \quad (13.47)$$

Where  $C_{D\infty}$  is the drag coefficient and is a function of Reynolds number,  $Re$ , and  $D$  is the equivalent radius of the particles. The Reynolds number defined as

$$Re = \frac{U_L D \rho_L}{\mu_L} \quad (13.48)$$

Inserting equating (13.48) into equation (13.47) become

$$\underbrace{C_{D\infty}(U_L)}_{f(Re)} U_L^2 = \frac{4 D g (\rho_S - \rho_L)}{3 \rho_L} \quad (13.49)$$

Equation (13.49) relates the liquid velocity that needed to maintain the particle "floating" to the liquid and particles properties. The drag coefficient,  $C_{D\infty}$  is complicated function of the Reynolds number. However, it can be approximated for several regimes. The first regime is for  $Re < 1$  where Stokes' Law can be approximated as

$$C_{D\infty} = \frac{24}{Re} \quad (13.50)$$

In transitional region  $1 < Re < 1000$

$$C_{D\infty} = \frac{24}{Re} \left( 1 + \frac{1}{6} Re^{2/3} \right) \quad (13.51)$$

For larger Reynolds numbers, the Newton's Law region,  $C_{D\infty}$ , is nearly constant as

$$C_{D\infty} = 0.44 \quad (13.52)$$

In most cases of solid-liquid system, the Reynolds number is in the second range<sup>9</sup>. For the first region, the velocity is small to lift the particle unless the density difference is very small (that very small force can lift the particles). In very large range (especially for gas) the choking might be approached. Thus, in many cases the middle region is applicable.

<sup>9</sup>It be wonderful if flow was in the last range? The critical velocity could be found immediately.

So far the discussion was about single particle. When there are more than one particle in the cross section, then the actual velocity that every particle experience depends on the void fraction. The simplest assumption that the change of the cross section of the fluid create a parameter that multiply the single particle as

$$C_{D\infty}|_{\alpha} = C_{D\infty} f(\alpha) \quad (13.53)$$

When the subscript  $\alpha$  is indicating the void, the function  $f(\alpha)$  is not a linear function. In the literature there are many functions for various conditions.

Minimum velocity is the velocity when the particle is “floating”. If the velocity is larger, the particle will drift with the liquid. When the velocity is lower, the particle will sink into the liquid. When the velocity of liquid is higher than the minimum velocity many particles will be floating. It has to remember that not all the particle are uniform in size or shape. Consequently, the minimum velocity is a range of velocity rather than a sharp transition point.

As the solid particles are not pushed by a pump but moved by the forces the fluid applies to them. Thus, the only velocity that can be applied is the fluid velocity. Yet, the solid particles can be supplied at different rate. Thus, the discussion will be focus on the fluid velocity. For small gas/liquid velocity, the particles are what some call fixed fluidized bed. Increasing the fluid velocity beyond a minimum will move the particles and it is referred to as mix fluidized bed. Additional increase of the fluid velocity will move all the particles and this is referred to as fully fluidized bed. For the case of liquid, further increase will create a slug flow. This slug flow is when slug shape (domes) are almost empty of the solid particle. For the case of gas, additional increase create “tunnels” of empty almost from solid particles. Additional increase in the fluid velocity causes large turbulence and the ordinary domes are replaced by churn type flow or large bubbles that are almost empty of the solid particles. Further increase of the fluid flow increases the empty spots to the whole flow. In that case, the sparse solid particles are dispersed all over. This regimes is referred to as Pneumatic conveying (see Figure 13.9).

One of the main difference between the liquid and gas flow in this category is the speed of sound. In the gas phase, the speed of sound is reduced dramatically with increase of the solid particles concentration (further reading *Fundamentals of Compressible Flow* chapter on Fanno Flow by this author is recommended). Thus, the velocity of gas is limited when reaching the Mach somewhere between  $1/\sqrt{k}$  and 1 since the gas will be choked (neglecting the double choking phenomenon). Hence, the length of conduit is very limited. The speed of sound of the liquid does not change much. Hence,

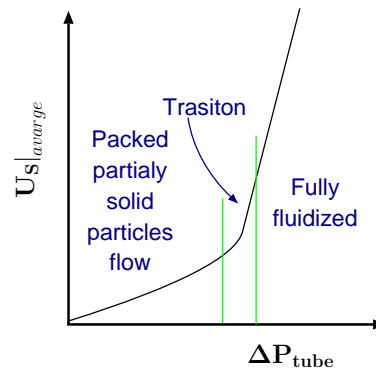

Fig. -13.8. The terminal velocity that left the solid particles.

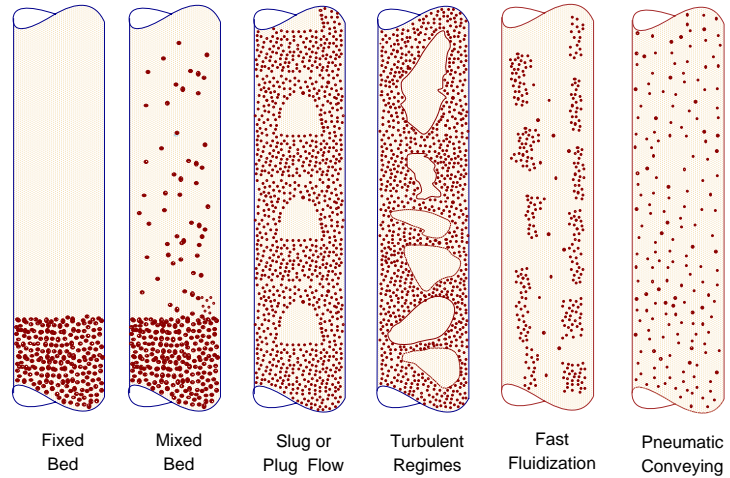

Fig. -13.9. The flow patterns in solid-liquid flow.

this limitation does not (effectively) exist for most cases of solid-liquid flow.

### 13.8.2 Solid With Lighter Density $\rho_S < \rho$ and With Gravity

This situation is minimal and very few cases exist. However, it must be pointed out that even in solid-gas, the fluid density can be higher than the solid (especially with micro gravity). There was very little investigations and known about the solid-liquid flowing down (with the gravity). Furthermore, there is very little knowledge about the solid-liquid when the solid density is smaller than the liquid density. There is no known flow map for this kind of flow that this author is aware of.

Nevertheless, several conclusions and/or expectations can be drawn. The issue of minimum terminal velocity is not exist and therefor there is no fixed or mixed fluidized bed. The flow is fully fluidized for any liquid flow rate. The flow can have slug flow but more likely will be in fast Fluidization regime. The forces that act on the spherical particle are the buoyancy force and drag force. The buoyancy is accelerating the particle and drag force are reducing the speed as

$$\frac{\pi D^3 g(\rho_S - \rho_L)}{6} = \frac{C_{D\infty} \pi D^2 \rho_L (U_S - U_L)^2}{8} \quad (13.54)$$

From equation 13.54, it can observed that increase of the liquid velocity will increase the solid particle velocity at the same amount. Thus, for large velocity of the fluid it can be observed that  $U_L/U_S \rightarrow 1$ . However, for a small fluid velocity the velocity ratio is very large,  $U_L/U_S \rightarrow 0$ . The affective body force "seems" by the particles can be in some cases larger than the gravity. The flow regimes will be similar but the transition will be in different points.



The solid-liquid horizontal flow has some similarity to horizontal gas-liquid flow. Initially the solid particles will be carried by the liquid to the top. When the liquid velocity increase and became turbulent, some of the particles enter into the liquid core. Further increase of the liquid velocity appear as somewhat similar to slug flow. However, this author have not seen any evidence that show the annular flow does not appear in solid-liquid flow.

### 13.9 Counter-Current Flow

This discussion will be only on liquid-liquid systems (which also includes liquid-gas systems). This kind of flow is probably the most common to be realized by the masses. For example, opening a can of milk or juice. Typically if only one hole is opened on the top of the can, the liquid will flow in pulse regime. Most people know that two holes are needed to empty the can easily and continuously. Otherwise, the flow will be in a pulse regime.

In most cases, the possibility to have counter-current flow is limited to having short length of tubes. In only certain configurations of the infinite long pipes the counter-current flow can exist. In that case, the pressure difference and gravity (body forces) dominates the flow. The inertia components of the flow, for long tubes, cannot compensate for the pressure gradient. In short tube, the pressure difference in one phase can be positive while the pressure difference in the other phase can be negative. The pressure difference in the interface must be finite. Hence, the counter-current flow can have opposite pressure gradient for short conduit. But in most cases, the heavy phase (liquid) is pushed by the gravity and lighter phase (gas) is driven by the pressure difference.

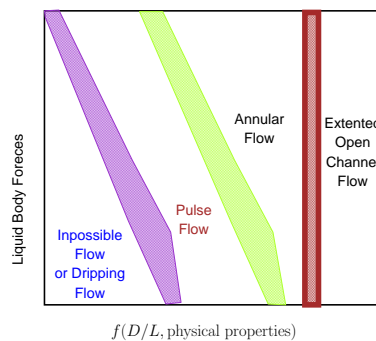
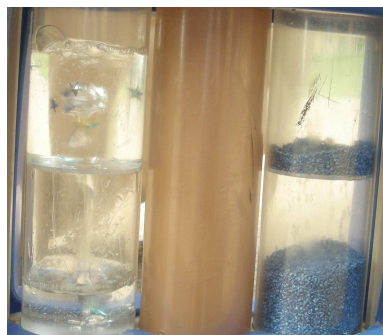

Fig. -13.10. Counter-flow in vertical tubes map.



Fig. -13.11. Counter-current flow in a can (the left figure) has only one hole thus pulse flow and a flow with two holes (right picture).

The counter-current flow occurs, for example, when cavity is filled or emptied with a liquid. The two phase regimes “occurs” mainly in entrance to the cavity. For example, Figure 13.11 depicts emptying of can filled with liquid. The air is “attempting” to enter the cavity to fill the vacuum created thus forcing pulse flow. If there are two holes, in some cases, liquid flows through one hole and the air through the second hole and the flow will be continuous. It also can be noticed that if there is one hole (orifice) and a long and narrow tube, the liquid will stay in the cavity (neglecting other phenomena such as dripping flow.).



*Fig. -13.12. Picture of Counter-current flow in liquid–gas and solid–gas configurations. The container is made of two compartments. The upper compartment is filled with the heavy phase (liquid, water solution, or small wood particles) by rotating the container. Even though the solid–gas ratio is smaller, it can be noticed that the solid–gas is faster than the liquid–gas flow.*

There are three flow regimes<sup>10</sup> that have been observed. The first flow pattern is pulse flow regime. In this flow regime, the phases flow turns into different direction (see Figure 13.12). The name pulse flow is used to signify that the flow is flowing in pulses that occurs in a certain frequency. This is opposed to counter–current solid–gas flow when almost no pulse was observed. Initially, due to the gravity, the heavy liquid is leaving the can. Then the pressure in the can is reduced compared to the outside and some lighter liquid (gas)entered into the can. Then, the pressure in the can increase, and some heavy liquid will starts to flow. This process continue until almost the liquid is evacuated (some liquid stay due the surface tension). In many situations, the volume flow rate of the two phase is almost equal. The duration the cycle depends on several factors. The cycle duration can be replaced by frequency. The analysis of the frequency is much more complex issue and will not be dealt here.

### **Annular Flow in Counter–current flow**

<sup>10</sup>Caution! this statement should be considered as “so far found” . There must be other flow regimes that were not observed or defined. For example, elongated pulse flow was observed but measured. This field hasn’t been well explored. There are more things to be examined and to be studied.

The other flow regime is annular flow in which the heavier phase is on the periphery of the conduit (In the literature, there are some one who claims that heavy liquid will be inside). The analysis is provided, but somehow it contradicts with the experimental evidence. Probably, one or more of the assumptions that the analysis based is erroneous). In very small diameters of tubes the counter-current flow is not possible because of the surface tension (see section 4.7). The ratio of the diameter to the length with some combinations of the physical properties (surface tension etc) determines the point where the counter flow can start. At this point, the pulsing flow will start and larger diameter will increase the flow and turn the flow into annular flow. Additional increase of the diameter will change the flow regime into extended open channel flow. Extended open channel flow retains the characteristic of open channel that the lighter liquid (almost) does not effect the heavier liquid flow. Example of such flow in the nature is water falls in which water flows down and air (wind) flows up.

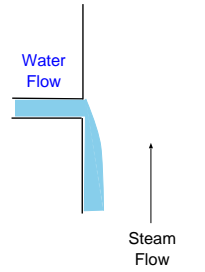

Fig. -13.13. Flood in vertical pipe.

The driving force is the second parameter which effects the flow existence. When the driving (body) force is very small, no counter-current flow is possible. Consider the can in zero gravity field, no counter-current flow possible. However, if the can was on the sun (ignoring the heat transfer issue), the flow regime in the can moves from pulse to annular flow. Further increase of the body force will move the flow to be in the extended "open channel flow."

In the vertical co-current flow there are two possibilities, flow with gravity or against it. As opposed to the co-current flow, the counter-current flow has no possibility for these two cases. The heavy liquid will flow with the body forces (gravity). Thus it should be considered as non existent flow.

### 13.9.1 Horizontal Counter-Current Flow

Up to this point, the discussion was focused on the vertical tubes. In horizontal tubes, there is an additional flow regime which is stratified. Horizontal flow is different from vertical flow from the stability issues. A heavier liquid layer can flow above a lighter liquid. This situation is unstable for large diameter but as in static (see section (4.7) page 139) it can be considered stable for small diameters. A flow in a very narrow tube with heavy fluid above the lighter fluid should be considered as a separate issue.

When the flow rate of both fluids is very small, the flow will be stratified counter-current flow. The flow will change to pulse flow when the heavy liquid flow rate increases. Further increase of the flow will result in a single phase flow regime. Thus, closing the window of this kind of flow. Thus,

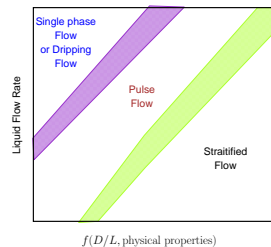

Fig. -13.14. A flow map to explain the horizontal counter-current flow.

this increase terminates the two phase flow possibility. The flow map of the horizontal flow is different from the vertical flow and is shown in Figure 13.14. A flow in an angle of inclination is closer to vertical flow unless the angle of inclination is very small. The stratified counter flow has a lower pressure loss (for the liquid side). The change to pulse flow increases the pressure loss dramatically.

### 13.9.2 Flooding and Reversal Flow

The limits of one kind the counter-current flow regimes, that is stratified flow are discussed here. This problem appears in nuclear engineering (or boiler engineering) where there is a need to make sure that liquid (water) inserted into the pipe reaching the heating zone. When there is no water (in liquid phase), the fire could melt or damage the boiler. In some situations, the fire can be too large or/and the water supply failed below a critical value the water turn into steam. The steam will flow in the opposite direction. To analyze this situation consider a two dimensional conduit with a liquid inserted in the left side as depicted in Figure 13.13. The liquid velocity at very low gas velocity is constant but not uniform. Further increase of the gas velocity will reduce the average liquid velocity. Additional increase of the gas velocity will bring it to a point where the liquid will flow in a reverse direction and/or disappear (dried out).

A simplified model for this situation is for a two dimensional configuration where the liquid is flowing down and the gas is flowing up as shown in Figure 13.15. It is assumed that both fluids are flowing in a laminar regime and steady state. Additionally, it is assumed that the entrance effects can be neglected. The liquid flow rate,  $Q_L$ , is unknown. However, the pressure difference in the ( $x$  direction) is known and equal to zero. The boundary conditions for the liquid is that velocity at the wall is zero and the velocity at the interface is the same for both phases  $U_G = U_L$  or  $\tau_i|_G = \tau_i|_L$ . As it will be shown later, both conditions cannot coexist. The model can be improved by considering turbulence, mass transfer, wavy interface, etc<sup>11</sup>.

This model is presented to exhibits the trends and the special features of counter-current flow. Assuming the pressure difference in the flow direction for the gas is constant and uniform. It is assumed that the last assumption does not contribute or change significantly the results. The underline rational for this assumption is that gas density does not change significantly for short pipes (for more information look for the book "Fundamentals of Compressible Flow" in Potto book series in the Fanno flow chapter.).

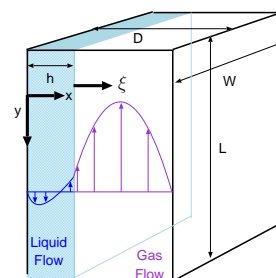

Fig. -13.15. A diagram to explain the flood in a two dimension geometry.

<sup>11</sup>The circular configuration is under construction and will be appeared as a separated article momentarily.

The liquid film thickness is unknown and can be expressed as a function of the above boundary conditions. Thus, the liquid flow rate is a function of the boundary conditions. On the liquid side, the gravitational force has to be balanced by the shear forces as

$$\frac{d\tau_{xy}}{dx} = \rho_L g \quad (13.55)$$

The integration of equation (13.55) results in

$$\tau_{xy} = \rho_L g x + C_1 \quad (13.56)$$

The integration constant,  $C_1$ , can be found from the boundary condition where  $\tau_{xy}(x = h) = \tau_i$ . Hence,

$$\tau_i = \rho_L g h + C_1 \quad (13.57)$$

The integration constant is then  $C_1 = \tau_i - \rho_L g h$  which leads to

$$\tau_{xy} = \rho_L g (x - h) + \tau_i \quad (13.58)$$

Substituting the newtonian fluid relationship into equation (13.58) to obtain

$$\mu_L \frac{dU_y}{dx} = \rho_L g (x - h) + \tau_i \quad (13.59)$$

or in a simplified form as

$$\frac{dU_y}{dx} = \frac{\rho_L g (x - h)}{\mu_L} + \frac{\tau_i}{\mu_L} \quad (13.60)$$

Equation (13.60) can be integrate to yield

$$U_y = \frac{\rho_L g}{\mu_L} \left( \frac{x^2}{2} - h x \right) + \frac{\tau_i x}{\mu_L} + C_2 \quad (13.61)$$

The liquid velocity at the wall,  $[U(x = 0) = 0]$ , is zero and the integration coefficient can be found to be

$$C_2 = 0 \quad (13.62)$$

The liquid velocity profile is then

$$U_y = \frac{\rho_L g}{\mu_L} \left( \frac{x^2}{2} - h x \right) + \frac{\tau_i x}{\mu_L} \quad (13.63)$$

The velocity at the liquid-gas interface is

$$U_y(x = h) = \frac{\tau_i h}{\mu_L} - \frac{\rho_L g h^2}{2 \mu_L} \quad (13.64)$$

The velocity can vanish (zero) inside the film in another point which can be obtained from

$$0 = \frac{\rho_L g}{\mu_L} \left( \frac{x^2}{2} - h x \right) + \frac{\tau_i x}{\mu_L} \quad (13.65)$$

The solution for equation (13.65) is

$$x|_{@U_L=0} = 2h - \frac{2\tau_i}{\mu_L g \rho_L} \quad (13.66)$$

The maximum  $x$  value is limited by the liquid film thickness,  $h$ . The minimum shear stress that start to create reversible velocity is obtained when  $x = h$  which is

$$0 = \frac{\rho_L g}{\mu_L} \left( \frac{h^2}{2} - h h \right) + \frac{\tau_i h}{\mu_L} \quad (13.67)$$

$$\hookrightarrow \tau_{i0} = \frac{h g \rho_L}{2}$$

If the shear stress is below this critical shear stress  $\tau_{i0}$  then no part of the liquid will have a reversed velocity. The notation of  $\tau_{i0}$  denotes the special value at which a starting shear stress value is obtained to have reversed flow. The point where the liquid flow rate is zero is important and it is referred to as initial flashing point.

The flow rate can be calculated by integrating the velocity across the entire liquid thickness of the film.

$$\frac{Q}{w} = \int_0^h U_y dx = \int_0^h \left[ \frac{\rho_L g}{\mu_L} \left( \frac{x^2}{2} - h x \right) + \frac{\tau_i x}{\mu_L} \right] dx \quad (13.68)$$

Where  $w$  is the thickness of the conduit (see Figure 13.15). Integration equation (13.68) results in

$$\frac{Q}{w} = \frac{h^2 (3\tau_i - 2g h \rho_L)}{6\mu_L} \quad (13.69)$$

It is interesting to find the point where the liquid mass flow rate is zero. This point can be obtained when equation (13.69) is equated to zero. There are three solutions for equation (13.69). The first two solutions are identical in which the film height is  $h = 0$  and the liquid flow rate is zero. But, also, the flow rate is zero when  $3\tau_i = 2g h \rho_L$ . This request is identical to the demand in which

$$\tau_{i \text{ critical}} = \frac{2g h \rho_L}{3} \quad (13.70)$$

This critical shear stress, for a given film thickness, reduces the flow rate to zero or effectively "drying" the liquid (which is different then equation (13.67)).

For this shear stress, the critical upward interface velocity is

$$U_{critical}|_{interface} = \frac{1}{6} \left( \frac{\rho_L g h^2}{\mu_L} \right) \quad (13.71)$$

The wall shear stress is the last thing that will be done on the liquid side. The wall shear stress is

$$\tau_L|_{@wall} = \mu_L \left. \frac{dU}{dx} \right|_{x=0} = \mu_L \left( \frac{\rho_L g}{\mu_L} \left( 2x - h \right) + \frac{\tau_i}{3} \frac{1}{\mu_L} \right) \Bigg|_{x=0} \quad (13.72)$$

Simplifying equation (13.72)<sup>12</sup> becomes (notice the change of the sign accounting for the direction)

$$\tau_L|_{@wall} = \frac{g h \rho_L}{3} \quad (13.73)$$

Again, the gas is assumed to be in a laminar flow as well. The shear stress on gas side is balanced by the pressure gradient in the  $y$  direction. The momentum balance on element in the gas side is

$$\frac{d\tau_{xyG}}{dx} = \frac{dP}{dy} \quad (13.74)$$

The pressure gradient is a function of the gas compressibility. For simplicity, it is assumed that pressure gradient is linear. This assumption means or implies that the gas is incompressible flow. If the gas was compressible with an ideal gas equation of state then the pressure gradient is logarithmic. Here, for simplicity reasons, the linear equation is used. In reality the logarithmic equation should be used ( a discussion can be found in "Fundamentals of Compressible Flow" a Potto project book). Thus, equation (13.74) can be rewritten as

$$\frac{d\tau_{xyG}}{dx} = \frac{\Delta P}{\Delta y} = \frac{\Delta P}{L} \quad (13.75)$$

Where  $\Delta y = L$  is the entire length of the flow and  $\Delta P$  is the pressure difference of the entire length. Utilizing the Newtonian relationship, the differential equation is

$$\frac{d^2 U_G}{dx^2} = \frac{\Delta P}{\mu_G L} \quad (13.76)$$

<sup>12</sup>Also noticing that equation (13.70) has to be equal  $g h \rho_L$  to support the weight of the liquid.

Equation (13.76) can be integrated twice to yield

$$U_G = \frac{\Delta P}{\mu_G L} x^2 + C_1 x + C_2 \quad (13.77)$$

This velocity profile must satisfy zero velocity at the right wall. The velocity at the interface is the same as the liquid phase velocity or the shear stress are equal. Mathematically these boundary conditions are

$$U_G(x = D) = 0 \quad (13.78)$$

and

$$\begin{aligned} U_G(x = h) &= U_L(x = h) & (a) & \quad \text{or} & (13.79) \\ \tau_G(x = h) &= \tau_L(x = h) & (b) & \end{aligned}$$

Applying B.C. (13.78) into equation (13.77) results in

$$\begin{aligned} U_G = 0 &= \frac{\Delta P}{\mu_G L} D^2 + C_1 D + C_2 & (13.80) \\ \hookrightarrow C_2 &= -\frac{\Delta P}{\mu_G L} D^2 + C_1 D \end{aligned}$$

Which leads to

$$U_G = \frac{\Delta P}{\mu_G L} (x^2 - D^2) + C_1 (x - D) \quad (13.81)$$

At the other boundary condition, equation (13.79)(a), becomes

$$\frac{\rho_L g h^2}{6 \mu_L} = \frac{\Delta P}{\mu_G L} (h^2 - D^2) + C_1 (h - D) \quad (13.82)$$

The last integration constant,  $C_1$  can be evaluated as

$$C_1 = \frac{\rho_L g h^2}{6 \mu_L (h - D)} - \frac{\Delta P (h + D)}{\mu_G L} \quad (13.83)$$

With the integration constants evaluated, the gas velocity profile is

$$U_G = \frac{\Delta P}{\mu_G L} (x^2 - D^2) + \frac{\rho_L g h^2 (x - D)}{6 \mu_L (h - D)} - \frac{\Delta P (h + D) (x - D)}{\mu_G L} \quad (13.84)$$

The velocity in Equation (13.84) is equal to the velocity equation (13.64) when ( $x = h$ ). However, in that case, it is easy to show that the gas shear stress is not equal to the liquid shear stress at the interface (when the velocities are assumed to be the equal). The difference in shear stresses at the interface due to this assumption, of the equal velocities, cause this assumption to be not physical.



The second choice is to use the equal shear stresses at the interface, condition (13.79)(b). This condition requires that

$$\mu_G \frac{dU_G}{dx} = \mu_L \frac{dU_L}{dx} \tag{13.85}$$

The expressions for the derivatives are

$$\overbrace{\frac{2h \Delta P}{L} + \mu_G C_1}^{\text{gas side}} = \overbrace{\frac{2gh\rho_L}{3}}^{\text{liquid side}} \tag{13.86}$$

As result, the integration constant is

$$C_1 = \frac{2gh\rho_L}{3\mu_G} - \frac{2h\Delta P}{\mu_G L} \tag{13.87}$$

The gas velocity profile is then

$$U_G = \frac{\Delta P}{\mu_G L} (x^2 - D^2) + \left( \frac{2gh\rho_L}{3\mu_G} - \frac{2h\Delta P}{\mu_G L} \right) (x - D) \tag{13.88}$$

The gas velocity at the interface is then

$$U_G|_{@x=h} = \frac{\Delta P}{\mu_G L} (h^2 - D^2) + \left( \frac{2gh\rho_L}{3\mu_G} - \frac{2h\Delta P}{\mu_G L} \right) (h - D) \tag{13.89}$$

This gas interface velocity is different than the velocity of the liquid side. The velocity at interface can have a “slip” in very low density and for short distances. The shear stress at the interface must be equal, if no special effects occurs. Since there no possibility to have both the shear stress and velocity on both sides of the interface, different thing(s) must happen. It was assumed that the interface is straight but is impossible. Then if the interface becomes wavy, the two conditions can co-exist.

The wall shear stress is

$$\tau_G|_{@wall} = \mu_G \left. \frac{dU_G}{dx} \right|_{x=D} = \mu_G \left( \frac{\Delta P 2x}{\mu_G L} + \left( \frac{2gh\rho_L}{3\mu_G} - \frac{2h\Delta P}{\mu_G L} \right) \right)_{x=D} \tag{13.90}$$

or in a simplified form as

$$\tau_G|_{@wall} = \frac{2\Delta P (D - h)}{L} + \frac{2gh\rho_L}{3} \tag{13.91}$$

**The Required Pressure Difference**

The pressure difference to create the flooding (drying) has to take into account the fact that the surface is wavy. However, as

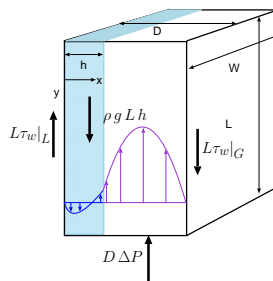

Fig. -13.16. General forces diagram to calculated the in a two dimension geometry.

first estimate the waviness of the surface can be neglected. The estimation of the pressure difference under the assumption of equal shear stress can be applied. In the same fashion the pressure difference under the assumption the equal velocity can be calculated. The actual pressure difference can be between these two assumptions but not must be between them. This model and its assumptions are too simplistic and the actual pressure difference is larger. However, this explanation is to show magnitudes and trends and hence it provided here.

To calculate the required pressure that cause the liquid to dry, the total balance is needed. The control volume include the gas and liquid volumes. Figure 13.16 describes the general forces that acts on the control volume. There are two forces that act against the gravity and two forces with the gravity. The gravity force on the gas can be neglected in most cases. The gravity force on the liquid is the liquid volume times the liquid volume as

$$F_{gL} = \rho g \overbrace{hL}^{\text{Volme/w}} \quad (13.92)$$

The total momentum balance is (see Figure 13.16)

$$F_{gL} + \overbrace{L}^{A/w} \tau_{w_c} = \overbrace{L}^{A/w} \tau_{w_l} + \overbrace{D \Delta P}^{\text{force due to pressure}} \quad (13.93)$$

Substituting the different terms into (13.93) result in

$$\rho g L h + L \left( \frac{2 \Delta P (D - h)}{L} + \frac{2 g h \rho_L}{3} \right) = L \frac{g h \rho_L}{3} + D \Delta P \quad (13.94)$$

Simplifying equation (13.94) results in

$$\frac{4 \rho g L h}{3} = (2 h - D) \Delta P \quad (13.95)$$

or

$$\Delta P = \frac{4 \rho g L h}{3 (2 h - D)} \quad (13.96)$$

This analysis shows far more reaching conclusion that initial anticipation expected. The interface between the two liquid flowing together is wavy. Unless the derivations or assumptions are wrong, this analysis equation (13.96) indicates that when  $D > 2 h$  is a special case (extend open channel flow).

### *13.10 Multi-Phase Conclusion*

For the first time multi-phase is included in a standard introductory textbook on fluid mechanics. There are several points that should be noticed in this chapter. There are many flow regimes in multi-phase flow that "regular" fluid cannot be used to solve it such as flooding. In that case, the appropriate model for the flow regime should be employed. The homogeneous models or combined models like Lockhart-Martinelli can be employed in some cases. In other case where more accurate measurement are needed a specific model is required. Perhaps as a side conclusion but important, the assumption of straight line is not appropriate when two liquid with different viscosity are flowing.



---

---

# APPENDIX A

---

## The Mathematics Backgrounds for Fluid Mechanics

In this appendix a review of selected topics in mathematics related to fluid mechanics is presented. These topics are present so that one with some minimal background could deal with the mathematics that encompass within basic fluid mechanics. Hence without additional reading, this book on fluid mechanics issues could be read by most readers. This appendix condenses material that spread in many various textbooks some of which are advance. Furthermore, some of the material appears in specialty books such as third order differential equations (and thus it is expected that the student is not familiar with this material.). There is very minimal original material which appears without proofs. The material is not presented in "educational" order but in importance order.

### A.1 Vectors

Vector is a quantity with direction as oppose to scalar. The length of the vector in Cartesian coordinates (the coordinates system is relevant) is

$$\|\mathbf{U}\| = \sqrt{U_x^2 + U_y^2 + U_z^2} \quad (\text{A.1})$$

Vector can be normalized and in Cartesian coordinates depicted in Figure A.1 where  $U_x$  is the vector component in the  $x$  direction,  $U_y$  is the vector component in the  $y$  direction, and  $U_z$  is the vector component in the  $z$  direction. Thus, the

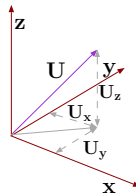

*Fig. -A.1. Vector in Cartesian coordinates system.*

unit vector is

$$\hat{U} = \frac{\mathbf{U}}{\|\mathbf{U}\|} = \frac{U_x}{\|\mathbf{U}\|} \hat{i} + \frac{U_y}{\|\mathbf{U}\|} \hat{j} + \frac{U_z}{\|\mathbf{U}\|} \hat{k} \quad (\text{A.2})$$

and general orthogonal coordinates

$$\hat{U} = \frac{\mathbf{U}}{\|\mathbf{U}\|} = \frac{U_1}{\|\mathbf{U}\|} \mathbf{h}_1 + \frac{U_2}{\|\mathbf{U}\|} \mathbf{h}_2 + \frac{U_3}{\|\mathbf{U}\|} \mathbf{h}_3 \quad (\text{A.3})$$

Vectors have some what similar rules to scalars which will be discussed in the next section.

### A.1.1 Vector Algebra

Vectors obey several standard mathematical operations which are applicable to scalars. The following are vectors,  $\mathbf{U}$ ,  $\mathbf{V}$ , and  $\mathbf{W}$  and for in this discussion  $a$  and  $b$  are scalars. Then the following can be said

1.  $(\mathbf{U} + \mathbf{V}) + \mathbf{W} = (\mathbf{U} + \mathbf{V} + \mathbf{W}) = \mathbf{U} + (\mathbf{V} + \mathbf{W})$
2.  $\mathbf{U} + \mathbf{V} = \mathbf{V} + \mathbf{U}$
3. Zero vector is such that  $\mathbf{U} + \mathbf{0} = \mathbf{U}$
4. Additive inverse  $\mathbf{U} - \mathbf{U} = \mathbf{0}$
5.  $a(\mathbf{U} + \mathbf{V}) = a\mathbf{U} + a\mathbf{V}$
6.  $a(b\mathbf{U}) = ab\mathbf{U}$

The multiplications and the divisions have somewhat different meaning in a scalar operations. There are two kinds of multiplications for vectors. The first multiplication is the “dot” product which is defined by equation (A.4). The results of this multiplication is scalar but has no negative value as in regular scalar multiplication.

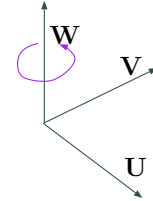

Fig. -A.2. The right hand rule, multiplication of  $\mathbf{U} \times \mathbf{V}$  results in  $\mathbf{W}$ .

$$\mathbf{U} \cdot \mathbf{V} = \underbrace{|\mathbf{U}| \cdot |\mathbf{V}|}_{\text{regular scalar multiplication}} \cos \underbrace{(\angle(\mathbf{U}, \mathbf{V}))}_{\text{angle between vectors}} \quad (\text{A.4})$$

The second multiplication is the “cross” product which in vector as opposed to a scalar as in the “dot” product. The “cross” product is defined in an orthogonal coordinate  $(\hat{h}_1, \hat{h}_2, \text{ and } \hat{h}_3)$  as

$$\mathbf{U} \times \mathbf{V} = |\mathbf{U}| \cdot |\mathbf{V}| \sin \underbrace{(\angle(\mathbf{U}, \mathbf{V}))}_{\text{angle}} \hat{\mathbf{n}} \quad (\text{A.5})$$

where  $\theta$  is the angle between  $\mathbf{U}$  and  $\mathbf{V}$ , and  $\hat{\mathbf{n}}$  is a unit vector perpendicular to both  $\mathbf{U}$  and  $\mathbf{V}$  which obeys the right hand rule. The right hand rule is referred to the direction of resulting vector. Note that  $\mathbf{U}$  and  $\mathbf{V}$  are not necessarily orthogonal. Additionally note that order of multiplication is significant. This multiplication has a negative value which means that it is a change of the direction.

One of the consequence of this definitions in Cartesian coordinates is

$$\hat{\mathbf{i}}^2 = \hat{\mathbf{j}}^2 = \hat{\mathbf{k}}^2 = 0 \tag{A.6}$$

In general for orthogonal coordinates this condition is written as

$$\hat{\mathbf{h}}_1 \times \hat{\mathbf{h}}_1 = \hat{\mathbf{h}}_2^2 = \hat{\mathbf{h}}_3^2 = 0 \tag{A.7}$$

where  $\hat{\mathbf{h}}_i$  is the unit vector in the orthogonal system.

In right hand orthogonal coordinate system

$$\begin{aligned} \hat{\mathbf{h}}_1 \times \hat{\mathbf{h}}_2 &= \hat{\mathbf{h}}_3 & \hat{\mathbf{h}}_2 \times \hat{\mathbf{h}}_1 &= -\hat{\mathbf{h}}_3 \\ \hat{\mathbf{h}}_2 \times \hat{\mathbf{h}}_3 &= \hat{\mathbf{h}}_1 & \hat{\mathbf{h}}_3 \times \hat{\mathbf{h}}_2 &= -\hat{\mathbf{h}}_1 \\ \hat{\mathbf{h}}_3 \times \hat{\mathbf{h}}_1 &= \hat{\mathbf{h}}_2 & \hat{\mathbf{h}}_1 \times \hat{\mathbf{h}}_3 &= -\hat{\mathbf{h}}_2 \end{aligned} \tag{A.8}$$

The “cross” product can be written as

$$\mathbf{U} \times \mathbf{V} = (U_2 V_3 - U_3 V_2) \hat{\mathbf{h}}_1 + (U_3 V_1 - U_1 V_3) \hat{\mathbf{h}}_2 + (U_1 V_2 - U_2 V_1) \hat{\mathbf{h}}_3 \tag{A.9}$$

Equation (A.9) in matrix form as

$$\mathbf{U} \times \mathbf{V} = \begin{pmatrix} \hat{\mathbf{h}}_1 & \hat{\mathbf{h}}_2 & \hat{\mathbf{h}}_3 \\ U_2 & U_2 & U_3 \\ V_2 & V_2 & V_3 \end{pmatrix} \tag{A.10}$$

The most complex of all these algebraic operations is the division. The multiplication in vector world have two definition one which results in a scalar and one which results in a vector. Multiplication combinations shows that there are at least four possibilities of combining the angle with scalar and vector. The reason that these current combinations, that is scalar associated with  $\cos \theta$  vectors is associated with  $\sin \theta$ , is that these combinations have physical meaning. The previous experience is that help to define multiplication help to definition the division. The number of the possible combinations of the division is very large. For example, the result of the division can be a scalar combined or associated with the angle (with  $\cos$  or  $\sin$ ), or vector with the angle, etc. However, these above four combinations are not the only possibilities (not including the left hand system). It turn out that these combinations have very little<sup>1</sup>

<sup>1</sup>This author did find any physical meaning these combinations but there could be and those the word “little” is used.

physical meaning. Additional possibility is that every combination of one vector element is divided by the other vector element. Since every vector element has three possible elements the total combination is  $9 = 3 \times 3$ . There at least are two possibilities how to treat these elements. It turned out that combination of three vectors has a physical meaning. The three vectors have a need for additional notation such of vector of vector which is referred to as a tensor. The following combination is commonly suggested

$$\frac{\mathbf{U}}{\mathbf{V}} = \begin{pmatrix} \frac{U_1}{V_1} & \frac{U_2}{V_1} & \frac{U_3}{V_1} \\ \frac{U_1}{V_2} & \frac{U_2}{V_2} & \frac{U_3}{V_2} \\ \frac{U_1}{V_3} & \frac{U_2}{V_3} & \frac{U_3}{V_3} \end{pmatrix} \quad (\text{A.11})$$

One such example of this division is the pressure which the explanation is commonality avoided or eliminated from the fluid mechanics books including the direct approach in this book.

This tensor or the matrix can undergo regular linear algebra operations such as finding the eigenvalue values and the eigen “vectors.” Also note the multiplying matrices and inverse matrix are also available operation to these tensors.

### A.1.2 Differential Operators of Vectors

Differential operations can act on scalar functions as well on vector and vector functions. More differential operations can on scalar function can results in vector or vector function. In multivariate calculus, derivatives of different directions can represented as a vector or vector function. A compact presentation is a common way to handle the mathematics which simplify the calculations and explanations. One of these operations is nabla operator sometimes also called the “del operator.” This operator is a differential vector. For example, in Cartesian coordinates the operation is

$$\nabla = \hat{i} \frac{\partial}{\partial x} + \hat{j} \frac{\partial}{\partial y} + \hat{k} \frac{\partial}{\partial z} \quad (\text{A.12})$$

Where  $\hat{i}$ ,  $\hat{j}$ , and  $\hat{k}$  are denoting unit vectors in the  $x$ ,  $y$ , and  $z$  directions, respectively. Many of the operations of vector world, such as, the gradient, divergence, the curl, and the Laplacian are based or could be constructed from this single operator.

#### Gradient

This operation acts on a scalar function and results in a vector whose components are derivatives in the principle directions of a coordinate system. A scalar function is a function that provide a valued based on the coordinates (in Cartesian coordinates  $x,y,z$ ). For example, the temperature of the domain might be expressed as a scalar field.

$$\nabla = \hat{i} \frac{\partial T}{\partial x} + \hat{j} \frac{\partial T}{\partial y} + \hat{k} \frac{\partial T}{\partial z} \quad (\text{A.13})$$



### Divergence

The same idea that was discussed in vector section there are two kinds of multiplication in the vector world and two will be for the differential operators. The divergence is the similar to “dot” product which results in scalar. A vector domain (function) assigns a vector to each point such as velocity for example,  $\mathbf{N}$ , for Cartesian coordinates is

$$\mathbf{N}(x, y, z) = N_x(x, y, z)\hat{\mathbf{i}} + N_y(x, y, z)\hat{\mathbf{j}} + N_z(x, y, z)\hat{\mathbf{k}} \quad (\text{A.14})$$

The *dot* product of these two vectors, in Cartesian coordinate is results in

$$\text{div } \mathbf{N} = \nabla \cdot \mathbf{N} = \frac{\partial N_x}{\partial x} + \frac{\partial N_y}{\partial y} + \frac{\partial N_z}{\partial z} \quad (\text{A.15})$$

The divergence results in a scalar function which similar to the concept of the vectors multiplication of the vectors magnitude by the cosine of the angle between the vectors.

### Curl

Similar to the “cross product” a similar operation can be defined for the nabla (note the “right hand rule” notation) for Cartesian coordinate as

$$\text{curl } \mathbf{N} = \nabla \times \mathbf{N} = \left( \frac{\partial N_z}{\partial y} - \frac{\partial N_y}{\partial z} \right) \hat{\mathbf{i}} + \left( \frac{\partial N_x}{\partial z} - \frac{\partial N_z}{\partial x} \right) \hat{\mathbf{j}} + \left( \frac{\partial N_y}{\partial x} - \frac{\partial N_x}{\partial y} \right) \hat{\mathbf{k}} \quad (\text{A.16})$$

Note that the result is a vector.

### Laplacian

The new operation can be constructed from “dot” multiplication of the nabla. A gradient acting on a scalar field creates a vector field. Applying a divergence on the result creates a scalar field again. This combined operations is known as the “div grad” which is given in Cartesian coordinates by

$$\nabla \cdot \nabla = \frac{\partial^2}{\partial x^2} + \frac{\partial^2}{\partial y^2} + \frac{\partial^2}{\partial z^2} \quad (\text{A.17})$$

This combination is commonality denoted as  $\nabla^2$ . This operator also referred as the Laplacian operator, in honor of Pierre-Simon Laplace (23 March 1749 – 5 March 1827).

### d’Alembertian

As a super-set for four coordinates (very minimal used in fluid mechanics) and it reffed to as d’Alembertian or the wave operator, and it defined as

$$\square^2 = \nabla^2 - \frac{1}{c^2} \frac{\partial^2}{\partial t^2} \quad (\text{A.18})$$

### Divergence Theorem

Mathematicians call to or refer to a subset of The Reynolds Transport Theorem as the Divergence Theorem, or called it Gauss' Theorem (Carl Friedrich Gauss 30 April 1777 – 23 February 1855), In Gauss notation it is written as

$$\iiint_V (\nabla \cdot \mathbf{N}) dV = \iint_A \mathbf{N} \cdot \mathbf{n} dA \quad (\text{A.19})$$

In Gauss-Ostrogradsky Theorem (Mikhail Vasilievich Ostrogradsky (September 24, 1801 – January 1, 1862). The notation is a bit different from Gauss and it is written in Ostrogradsky notation as

$$\int_V \left( \frac{\partial P}{\partial x} + \frac{\partial Q}{\partial y} + \frac{\partial R}{\partial z} \right) dx dy dz = \int_{\Sigma} (Pp + Qq + Rr) d\Sigma \quad (\text{A.20})$$

Note the strange notation of “ $\Sigma$ ” which refers to the area. This theorem is applicable for a fix control volume and the derivative can enters into the integral. Many engineering class present this theorem as a theorem on its merit without realizing that it is a subset of Reynolds Transport Theorem. This subset can further produces several interesting identities. If  $\mathbf{N}$  is a gradient of a scalar field  $\Pi(x, y, z)$  then it can insert into identity to produce

$$\iiint_V (\nabla \cdot (\nabla \Phi)) dV = \iiint_V (\nabla^2 \Phi) dV = \iint_A \nabla \Phi \cdot \mathbf{n} dA \quad (\text{A.21})$$

Since the definition of  $\nabla \Phi = \mathbf{N}$ .

Special case of equation (A.21) for harmonic function (solutions Laplace equation see<sup>2</sup> Harminic functions) then the left side vanishes which is useful identity for ideal flow analysis. This results reduces equation, normally for steady state, to a balance of the fluxes through the surface. Thus, the harmonic functions can be added or subtracted because inside the volume these functions contributions is eliminated throughout the volume.

### A.1.3 Differentiation of the Vector Operations

The vector operation sometime fell under (time or other) derivative. The basic of these relationships is explored. A vector is made of the several scalar functions such as

$$\vec{\mathbf{R}} = f_1(x_1, x_2, x_3, \dots) \hat{\mathbf{e}}_1 + f_2(x_1, x_2, x_3, \dots) \hat{\mathbf{e}}_2 + f_3(x_1, x_2, x_3, \dots) \hat{\mathbf{e}}_3 + \dots \quad (\text{A.22})$$

where  $\hat{\mathbf{e}}_i$  is the unit vector in the  $i$  direction. The cross and dot products when the come under differentiation can be look as scalar. For example, the dot product of operation

<sup>2</sup>for more information  
<http://math.fullerton.edu/mathews/c2003/HarmonicFunctionMod.html>

$\mathbf{R} \cdot \mathbf{S} = (x\hat{i} + y^2\hat{j}) \cdot (\sin x\hat{i} + \exp(y)\hat{j})$  can be written as

$$\frac{d(\mathbf{R} \cdot \mathbf{S})}{dt} = \frac{d}{dt} \left( (x\hat{i} + y^2\hat{j}) \cdot (\sin x\hat{i} + \exp(y)\hat{j}) \right)$$

It can be noticed that

$$\begin{aligned} \frac{d(\mathbf{R} \cdot \mathbf{S})}{dt} &= \frac{d(x \sin x + y^2 \exp(y))}{dt} = \\ &= \frac{dx}{dt} \sin x + \frac{d \sin x}{dt} x + \frac{dy^2}{dt} \exp(y) + \frac{dy^2}{dt} \exp(y) \end{aligned}$$

It can be noticed that the manipulation of the simple above example obeys the regular chain rule. Similarly, it can be done for the cross product. The results of operations of two vectors is similar to regular multiplication since the vectors operation obey “regular” addition and multiplication roles, the chain rule is applicable. Hence the chain rule applies for dot operation,

$$\frac{d}{dt} (\mathbf{R} \cdot \mathbf{S}) = \frac{d\mathbf{R}}{dt} \cdot \mathbf{S} + \frac{d\mathbf{S}}{dt} \cdot \mathbf{R} \quad (\text{A.23})$$

And the chain rule for the cross operation is

$$\frac{d}{dt} (\mathbf{R} \times \mathbf{S}) = \frac{d\mathbf{R}}{dt} \times \mathbf{S} + \frac{d\mathbf{S}}{dt} \times \mathbf{R} \quad (\text{A.24})$$

It follows that derivative (notice the similarity to scalar operations) of

$$\frac{d}{dt} (\mathbf{R} \cdot \mathbf{R}) = 2\mathbf{R} \frac{d\mathbf{R}}{dt}$$

There are several identities related to location, velocity, and acceleration. As in operation on scalar time derivative of dot or cross of constant velocity is zero. Yet, the most interesting is

$$\frac{d}{dt} (\mathbf{R} \times \mathbf{U}) = \mathbf{U} \times \mathbf{U} + \mathbf{R} \times \frac{d\mathbf{U}}{dt} \quad (\text{A.25})$$

The first part is zero because the cross product with itself is zero. The second part is zero because Newton law (acceleration is along the path of R).

### A.1.3.1 Orthogonal Coordinates

These vectors operations can appear in different orthogonal coordinates system. There are several orthogonal coordinates which appears in fluid mechanics operation which include this list: Cartesian coordinates, Cylindrical coordinates, Spherical coordinates, Parabolic coordinates, Parabolic cylindrical coordinates, Paraboloidal coordinates, Oblate spheroidal coordinates, Prolate spheroidal coordinates, Ellipsoidal coordinates, Elliptic

cylindrical coordinates, Toroidal coordinates, Bispherical coordinates, Bipolar cylindrical coordinates, Conical coordinates, Flat-ring cyclide coordinates, Flat-disk cyclide coordinates, Bi-cyclide coordinates and Cap-cyclide coordinates. Because there are so many coordinates system is reasonable to develop these operations for any for any coordinates system. Three common systems typical to fluid mechanics will be presented and followed by a table and methods to present all the above equations.

### Cylindrical Coordinates

The cylindrical coordinates are commonly used in situations where there is line of symmetry or kind of symmetry. This kind situations occur in pipe flow even if the pipe is not exactly symmetrical. These coordinates reduced the work, in most cases, because problem is reduced a two dimensions. Historically, these coordinate were introduced for geometrical problems about 2000 years ago<sup>3</sup>. The cylindrical coordinates are shown in Figure A.3. In the figure shows that the coordinates are  $r$ ,  $\theta$ , and  $z$ . Note that unite coordinates are denoted as  $\hat{r}$ ,  $\hat{\theta}$ , and  $\hat{z}$ . The meaning of  $\vec{r}$  and  $\hat{r}$  are different. The first one represents the vector that is the direction of  $\hat{r}$  while the second is the unit vector in the direction of the coordinate  $r$ . These three different  $r$ s are some what similar to any of the Cartesian coordinate. The second coordinate  $\theta$  has unite coordinate  $\hat{\theta}$ . The new concept here is the length factor. The coordinate  $\theta$  is angle. In this book the dimensional chapter shows that in physics that derivatives have to have same units in order to compare them or use them. Conversation of the angel to units of length is done by length factor which is, in this case,  $r$ . The conversion between the Cartesian coordinate and the Cylindrical is

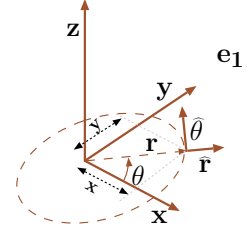

Fig. -A.3. Cylindrical Coordinate System.

$$r = \sqrt{x^2 + y^2} \quad \theta = \arctan \frac{y}{x} \quad z = z \quad (\text{A.26})$$

The reverse transformation is

$$x = r \cos \theta \quad y = r \sin \theta \quad z = z \quad (\text{A.27})$$

The line element and volume element are

$$ds = \sqrt{dr^2 + (r d\theta)^2 + dz^2} \quad dr r d\theta dz \quad (\text{A.28})$$

The gradient in cylindrical coordinates is given by

$$\nabla = \hat{r} \frac{\partial}{\partial r} + \hat{\theta} \frac{1}{r} \frac{\partial}{\partial \theta} + \hat{z} \frac{\partial}{\partial z} \quad (\text{A.29})$$

<sup>3</sup>Coolidge, Julian (1952). "The Origin of Polar Coordinates". American Mathematical Monthly 59: 7885. [http://www-history.mcs.st-and.ac.uk/Extras/Coolidge\\_Polars.html](http://www-history.mcs.st-and.ac.uk/Extras/Coolidge_Polars.html). Note the advantage of cylindrical (polar) coordinates in description of geometry or location relative to a center point.

The curl is written

$$\nabla \times \mathbf{N} = \left( \frac{1}{r} \frac{\partial N_z}{\partial \theta} - \frac{\partial N_\theta}{\partial z} \right) \hat{\mathbf{r}} + \left( \frac{\partial N_r}{\partial z} - \frac{\partial N_z}{\partial r} \right) \hat{\boldsymbol{\theta}} + \quad (\text{A.30})$$

$$\frac{1}{r} \left( \frac{\partial (r N_\theta)}{\partial r} - \frac{\partial N_\theta}{\partial \theta} \right) \hat{\mathbf{z}} \quad (\text{A.31})$$

The Laplacian is defined by

$$\nabla \cdot \nabla = \frac{1}{r} \frac{\partial}{\partial r} \left( r \frac{\partial}{\partial r} \right) + \frac{1}{r^2} \frac{\partial^2}{\partial \theta^2} + \frac{\partial^2}{\partial z^2} \quad (\text{A.32})$$

### Spherical Coordinates

The spherical coordinates system is a three-dimensional coordinates which is improvement or further modifications of the cylindrical coordinates. Spherical system used for cases where spherical symmetry exist. In fluid mechanics such situations exist in bubble dynamics, boom explosion, sound wave propagation etc. A location is represented by a radius and two angles. Note that the first angle (azimuth or longitude)  $\theta$  range is between  $0 < \theta < 2\pi$  while the second angle (colatitude) is only  $0 < \phi < \pi$ . The radius is the distance between the origin and the location. The first angle between projection on  $x-y$  plane and the positive  $x$ -axis. The second angle is between the positive  $y$ -axis and the vector as shown in Figure A.4.

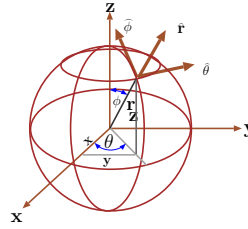

Fig. -A.4. Spherical Coordinate System.

The conversion between Cartesian coordinates to Spherical coordinates

$$x = r \sin \phi \cos \theta \quad y = r \sin \phi \sin \theta \quad z = r \cos \phi \quad (\text{A.33})$$

The reversed transformation is

$$r = \sqrt{x^2 + y^2 + z^2} \quad \phi = \arccos \left( \frac{z}{r} \right) \quad (\text{A.34})$$

Line element and element volume are

$$ds = \sqrt{dr^2 + (r \cos \theta d\theta)^2 + (r \sin \theta d\phi)^2} \quad dV = r^2 \sin \theta dr d\theta d\phi \quad (\text{A.35})$$

The gradient is

$$\nabla = \hat{\mathbf{r}} \frac{\partial}{\partial r} + \hat{\boldsymbol{\theta}} \frac{1}{r} \frac{\partial}{\partial \theta} + \hat{\boldsymbol{\phi}} \frac{1}{r \sin \theta} \frac{\partial}{\partial \phi} \quad (\text{A.36})$$

The divergence in spherical coordinate is

$$\nabla \cdot \mathbf{N} = \frac{1}{r^2} \frac{\partial (r^2 N_r)}{\partial r} + \frac{1}{r \sin \theta} \frac{\partial (N_\theta \sin \theta)}{\partial \theta} + \frac{1}{r \sin \theta} \frac{\partial N_\phi}{\partial \phi} \quad (\text{A.37})$$

The curl in spherical coordinates is

$$\begin{aligned} \nabla \times \mathbf{N} = & \frac{1}{r \sin \theta} \left( \frac{\partial (N_\phi \sin \theta)}{\partial \theta} - \frac{\partial N_\theta}{\partial \phi} \right) \hat{\mathbf{r}} + \\ & \frac{1}{r} \left( \frac{1}{\sin \theta} \frac{\partial N_r}{\partial \phi} - \frac{\partial (r N_\phi)}{\partial r} \right) \hat{\boldsymbol{\theta}} + \frac{1}{r} \left( \frac{\partial (r N_\theta)}{\partial r} - \frac{\partial N_r}{\partial \theta} \right) \hat{\boldsymbol{\phi}} \end{aligned} \quad (\text{A.38})$$

The Laplacian in spherical coordinates is

$$\nabla^2 = \frac{1}{r^2} \frac{\partial}{\partial r} \left( r^2 \frac{\partial}{\partial r} \right) + \frac{1}{r^2 \sin \theta} \frac{\partial}{\partial \theta} \left( \sin \theta \frac{\partial}{\partial \theta} \right) + \frac{1}{r^2 \sin^2 \theta} \frac{\partial^2}{\partial \phi^2} \quad (\text{A.39})$$

### General Orthogonal Coordinates

There are several orthogonal system and general form is needed. The notation for the presentation is required general notation of the units vectors is  $\hat{e}_i$  and coordinates distance coefficient is  $h_i$  where  $i$  is 1,2,3. The coordinates distance coefficient is the change the differential to the actual distance. For example in cylindrical coordinates, the unit vectors are:  $\hat{\mathbf{r}}$ ,  $\hat{\boldsymbol{\theta}}$ , and  $\hat{\mathbf{z}}$ . The units  $\hat{\mathbf{r}}$  and  $\hat{\mathbf{z}}$  are units with length. However,  $\hat{\boldsymbol{\theta}}$  is lengthens unit vector and the coordinate distance coefficient in this case is  $r$ . As in almost all cases, there is dispute what the proper notation for these coefficients. In mathematics it is denoted as  $q$  while in engineering is denotes  $h$ . Since it is engineering book the  $h$  is adapted. Also note that the derivative of the coordinate in the case of cylindrical coordinate is  $\partial\theta$  and unit vector is  $\hat{\boldsymbol{\theta}}$ . While the  $\theta$  is the same the meaning is different and different notations need. The derivative quantity will be denoted by  $q$  superscript.

The length of

$$d\ell^2 = \sum_{i=1}^d (h_i dq^i)^2 \quad (\text{A.40})$$

The nabla operator in general orthogonal coordinates is

$$\nabla = \frac{\hat{e}_1}{h_1} \frac{\partial}{\partial q^1} + \frac{\hat{e}_2}{h_2} \frac{\partial}{\partial q^2} + \frac{\hat{e}_3}{h_3} \frac{\partial}{\partial q^3} \quad (\text{A.41})$$

### Gradient

The gradient in general coordinate for a scalar function  $T$  is the nabla operator in general orthogonal coordinates as

$$\nabla T = \frac{\hat{e}_1}{h_1} \frac{\partial T}{\partial q^1} + \frac{\hat{e}_2}{h_2} \frac{\partial T}{\partial q^2} + \frac{\hat{e}_3}{h_3} \frac{\partial T}{\partial q^3} \quad (\text{A.42})$$

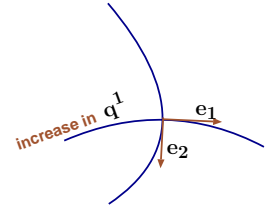

Fig. -A.5. The general Orthogonal with unit vectors.

The divergence of a vector equals

$$\nabla \cdot \mathbf{N} = \frac{1}{h_1 h_2 h_3} \left[ \frac{\partial}{\partial q^1} (N_1 h_2 h_3) + \frac{\partial}{\partial q^2} (N_2 h_3 h_1) + \frac{\partial}{\partial q^3} (N_3 h_1 h_2) \right]. \quad (\text{A.43})$$

For general orthogonal coordinate system the curl is

$$\begin{aligned} \nabla \times \mathbf{N} = & \frac{\hat{e}_1}{h_2 h_3} \left[ \frac{\partial}{\partial q^2} (h_3 N_3) - \frac{\partial}{\partial q^3} (h_2 N_2) \right] + \\ & \frac{\hat{e}_2}{h_3 h_1} \left[ \frac{\partial}{\partial q^3} (h_1 N_1) - \frac{\partial}{\partial q^1} (h_3 N_3) \right] + \frac{\hat{e}_3}{h_1 h_2} \left[ \frac{\partial}{\partial q^1} (h_2 N_2) - \frac{\partial}{\partial q^2} (h_1 N_1) \right] \end{aligned} \quad (\text{A.44})$$

The Laplacian of a scalar equals

$$\nabla^2 \phi = \frac{1}{h_1 h_2 h_3} \left[ \frac{\partial}{\partial q^1} \left( \frac{h_2 h_3}{h_1} \frac{\partial \phi}{\partial q^1} \right) + \frac{\partial}{\partial q^2} \left( \frac{h_3 h_1}{h_2} \frac{\partial \phi}{\partial q^2} \right) + \frac{\partial}{\partial q^3} \left( \frac{h_1 h_2}{h_3} \frac{\partial \phi}{\partial q^3} \right) \right] \quad (\text{A.45})$$

The following table showing the different values for selected orthogonal system.

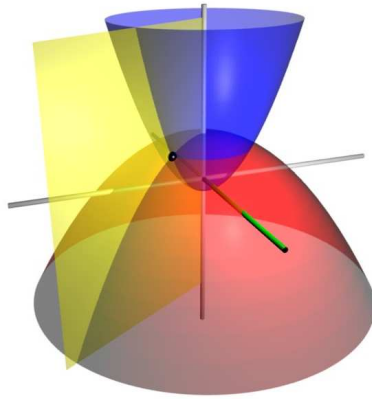

Fig. -A.6. Parabolic coordinates by user WillowW using Blender.

Table -A.1. Orthogonal coordinates systems (under construction please ignore)

Orthogonal coordinates systems	Remarks	$h$			$q$		
name		1	2	3	1	2	3
Cartesian	standard	1	1	1	$x$	$y$	$z$
Cylindrical	common	1	$r$	1	$r$	$\theta$	$z$
Spherical	common	1	$r$	$r \cos \theta$	$r$	$\theta$	$\varphi$
Paraboloidal	?	$\sqrt{u^2 + v^2}$	$\sqrt{u^2 + v^2}$	$u v$	$u$	$v$	$\theta$
Ellipsoidal	?				$\lambda$	$\mu$	$\nu$

## A.2 Ordinary Differential Equations (ODE)

In this section a brief summary of ODE is presented. It is not intent to be a replacement to a standard textbook but as a quick reference. It is suggested that the reader interested in depth information should read "Differential Equations and Boundary Value Problems" by Boyce de-Prima or any other book in this area. Ordinary differential equations are defined by the order of the highest derivative. If the highest derivative is first order the equation is referred as first order differential equation etc. Note that the derivatives are integers e.g. first derivative, second derivative etc<sup>4</sup>. ODE are categorized into linear and non-linear equations. The meaning of linear equation is that the operation is such that

$$a L(u_1) + b L(u_2) = L(a u_1 + b u_2) \quad (\text{A.46})$$

An example of such linear operation  $L = \frac{d}{dt} + 1$  acting on  $y$  is  $\frac{dy_1}{dt} + y_1$ . Or this operation on  $y_2$  is  $\frac{dy_2}{dt} + y_2$  and the summation of operation the sum operation of  $L(y_1 + y_2) = \frac{y_1 + y_2}{dt} + y_1 + y_2$ .

### A.2.1 First Order Differential Equations

As expect, the first ODEs are easier to solve and they are the base for equations of higher order equation. The first order equations have several forms and there is no one solution fit all but families of solutions. The most general form is

$$f\left(u, \frac{du}{dt}, t\right) = 0 \quad (\text{A.47})$$

<sup>4</sup>Note that mathematically, it is possible to define fraction of derivative. However, there is no physical meaning to such a product according to this author believe.



Sometimes equation (A.47) can be simplified to the first form as

$$\frac{du}{dt} = F(t, u) \quad (\text{A.48})$$

### A.2.2 Variables Separation or Segregation

In some cases equation (A.48) can be written as  $F(t, u) = X(t)U(u)$ . In that case it is said that  $F$  is separable and then equation (A.48) can be written as

$$\frac{du}{U(u)} = X(t)dt \quad (\text{A.49})$$

Equation can be integrated either analytically or numerically and the solution is

$$\int \frac{du}{U(u)} = \int X(t)dt \quad (\text{A.50})$$

The limits of the integral is (are) the initial condition(s). The initial condition is the value the function has at some points. The name initial condition is used because the values are given commonly at initial time.

**Example A.1:**

*Solve the following equation*

$$\frac{du}{dt} = u t \quad (\text{1.1.a})$$

with the initial condition  $u(t = 0) = u_0$ .

#### SOLUTION

The solution can be obtained by the variable separation method. The separation yields

$$\frac{du}{u} = t dt \quad (\text{1.1.b})$$

The integration of equation (1.1.b) becomes

$$\int \frac{du}{u} = \int t dt \implies \ln(u) + \ln(c) = \frac{t^2}{2} \quad (\text{1.1.c})$$

Equation (1.1.c) can be transferred to

$$u = c e^{t^2} \quad (\text{1.1.d})$$

For the initial condition of  $u(0) = u_0$  then

$$u = u_0 e^{t^2} \quad (\text{1.1.e})$$

### A.2.2.1 The Integral Factor Equations

Another method is referred to as integration factor which deals with a limited but very important class of equations. This family is part of a linear equations. The general form of the equation is

$$\frac{dy}{dx} + g(x)y = m(x) \quad (\text{A.51})$$

Multiplying equation (A.51) by unknown function  $N(x)$  transformed it to

$$N(x) \frac{dy}{dx} + N(x)g(x)y = N(x)m(x) \quad (\text{A.52})$$

What is needed from  $N(x)$  is to provide a full differential such as

$$N(x) \frac{dy}{dx} + N(x)g(x)y = \frac{d[N(x)g(x)y]}{dx} \quad (\text{A.53})$$

This condition (note that the previous methods is employed here) requires that

$$\frac{dN(x)}{dx} = N(x)g(x) \implies \frac{dN(x)}{N(x)} = g(x) dx \quad (\text{A.54})$$

Equation (A.54) is integrated to be

$$\ln(N(x)) = \int g(x)dx \implies N(x) = e^{\int g(x)dx} \quad (\text{A.55})$$

Using the differentiation chain rule provides

$$\frac{dN(x)}{dx} = e^{\int g(x)dx} \overbrace{\frac{d}{dx}}^{\frac{dx}{du}} \underbrace{g(x)}_{\frac{du}{dx}} \quad (\text{A.56})$$

which indeed satisfy equation (A.53). Thus equation (A.52) becomes

$$\frac{d[N(x)g(x)y]}{dx} = N(x)m(x) \quad (\text{A.57})$$

Multiplying equation (A.57) by  $dx$  and integrating results in

$$N(x)g(x)y = \int N(x)m(x) dx \quad (\text{A.58})$$

The solution is then

$$y = \frac{\int N(x)m(x) dx}{g(x) \underbrace{e^{\int g(x)dx}}_{N(x)}} \quad (\text{A.59})$$

A special case of  $g(t) = \text{constant}$  is shown next.

**Example A.2:**

Find the solution for a typical problem in fluid mechanics (the problem of Stoke flow or the parachute problem) of

$$\frac{dy}{dx} + y = 1$$

SOLUTION

Substituting  $m(x) = 1$  and  $g(x) = 1$  into equation (A.59) provides

$$y = e^{-x} (e^x + c) = 1 + c e^{-x}$$

---

End Solution

---

**A.2.3 Non-Linear Equations**

Non-Linear equations are equations that the power of the function or the function derivative is not equal to one or their combination. Many non linear equations can be transformed into linear equations and then solved with the linear equation techniques. One such equation family is referred in the literature as the Bernoulli Equations<sup>5</sup>. This equation is

$$\frac{du}{dt} + m(t)u = n(t) \overbrace{u^p}^{\text{non-linear part}} \quad (\text{A.60})$$

The transformation  $v = u^{1-p}$  turns equation (A.60) into a linear equation which is

$$\frac{dv}{dt} + (1-p)m(t)v = (1-p)n(t) \quad (\text{A.61})$$

The linearized equation can be solved using the linear methods. The actual solution is obtained by reversed equation which transferred solution to

$$u = v^{(p-1)} \quad (\text{A.62})$$

**Example A.3:**

Solve the following Bernoulli equation

$$\frac{du}{dt} + t^2 u = \sin(t) u^3 \quad (\text{1.III.a})$$

---

<sup>5</sup>Not to be confused with the Bernoulli equation without the  $s$  that referred to the energy equation.

SOLUTION

The transformation is

$$v = u^2 \quad (1.111.b)$$

Using the definition (1.111.b) equation (1.111.a) becomes

$$\frac{dv}{dt} \overbrace{-2}^{1-p} t^2 v = \overbrace{-2}^{1-p} \sin(t) \quad (1.111.c)$$

The homogeneous solution of equation (1.111.c) is

$$u(t) = ce^{-\frac{t^3}{3}} \quad (1.111.d)$$

And the general solution is

$$u = e^{-\frac{t^3}{3}} \left( \overbrace{\int e^{\frac{t^3}{3}} \sin(t) dt + c}^{\text{private solution}} \right) \quad (1.111.e)$$

---

End Solution

**A.2.3.1 Homogeneous Equations**

Homogeneous function is given as

$$\frac{du}{dt} = f(u, t) = f(au, at) \quad (A.63)$$

for any real positive  $a$ . For this case, the transformation of  $u = vt$  transforms equation (A.63) into

$$t \frac{dv}{dt} + v = f(1, v) \quad (A.64)$$

In another words if the substitution  $u = vt$  is inserted the function  $f$  become a function of only  $v$  it is homogeneous function. Example of such case  $u' = (u^3 - t^3)/t^3$  becomes  $u' = (v^3 + 1)$ . The solution is then

$$\ln |t| = \int \frac{dv}{f(1, v) - v} + c \quad (A.65)$$

**Example A.4:**

*Solve the equation*

$$\frac{du}{dt} = \sin\left(\frac{u}{t}\right) + \left(\frac{u^4 - t^4}{t^4}\right) \quad (1.IV.a)$$

SOLUTION

Substituting  $u = vT$  yields

$$\frac{du}{dt} = \sin(v) + v^4 - 1 \quad (1.IV.b)$$

or

$$t \frac{dv}{dt} + v = \sin(v) + v^4 - 1 \implies t \frac{dv}{dt} = \sin(v) + v^4 - 1 - v \quad (1.IV.c)$$

Now equation (1.IV.c) can be solved by variable separation as

$$\frac{dv}{\sin(v) + v^4 - 1 - v} = t dt \quad (1.IV.d)$$

Integrating equation (1.IV.d) results in

$$\int \frac{dv}{\sin(v) + v^4 - 1 - v} = \frac{t^2}{2} + c \quad (1.IV.e)$$

The initial condition can be inserted via the boundary of the integral.

---

End Solution

**A.2.3.2 Variables Separable Equations**

In fluid mechanics and many other fields there are differential equations that referred to variables separable equations. In fact, this kind of class of equations appears all over this book. For this sort equations, it can be written that

$$\frac{du}{dt} = f(t)g(u) \quad (A.66)$$

The main point is that  $f(t)$  and be segregated from  $g(u)$ . The solution of this kind of equation is

$$\int \frac{du}{g(u)} = \int f(t) dt \quad (A.67)$$

**Example A.5:**

Solve the following ODE

$$\frac{du}{dt} = -u^2 t^2 \quad (1.V.a)$$

SOLUTION

Segregating the variables to be

$$\int \frac{du}{u^2} = \int t^2 dt \quad (1.V.b)$$

Integrating equation (1.V.b) transformed into

$$-\frac{1}{u} = \frac{t^3}{3} + c_1 \quad (1.V.c)$$

Rearranging equation (1.V.c) becomes

$$u = \frac{-3}{t^3 + c} \quad (1.V.d)$$

---

End Solution

### A.2.3.3 Other Equations

There are equations or methods that were not covered by the above methods. There are additional methods such numerical analysis, transformation (like Laplace transform), variable substitutions, and perturbation methods. Many of these methods will be eventually covered by this appendix.

## A.2.4 Second Order Differential Equations

The general idea of solving second order ODE is by converting them into first order ODE. One such case is the second order ODE with constant coefficients.

The simplest equations are with constant coefficients such as

$$a \frac{d^2u}{dt^2} + b \frac{du}{dt} + cu = 0 \quad (A.68)$$

In a way, the second order ODE is transferred to first order by substituting the one linear operator to two first linear operators. Practically, it is done by substituting  $e^{st}$  where  $s$  is characteristic constant and results in the quadratic equation

$$as^2 + bs + c = 0 \quad (A.69)$$

If  $b^2 > 4ac$  then there are two unique solutions for the quadratic equation and the general solution form is

$$u = c_1 e^{s_1 t} + c_2 e^{s_2 t} \quad (A.70)$$

For the case of  $b^2 = 4ac$  the general solution is

$$u = c_1 e^{s_1 t} + c_2 t e^{s_1 t} \quad (A.71)$$

In the case of  $b^2 < 4ac$ , the solution of the quadratic equation is a complex number which means that the solution has exponential and trigonometric functions as

$$u = c_1 e^{\alpha t} \cos(\beta t) + c_2 e^{\alpha t} \sin(\beta t) \quad (A.72)$$

Where the real part is

$$\alpha = \frac{-b}{2a} \quad (\text{A.73})$$

and the imaginary number is

$$\beta = \frac{\sqrt{4ac - b^2}}{2a} \quad (\text{A.74})$$

**Example A.6:**

Solve the following ODE

$$\frac{d^2u}{dt^2} + 7\frac{du}{dt} + 10u = 0 \quad (\text{1.VI.a})$$

SOLUTION

The characteristic equation is

$$s^2 + 7s + 10 = 0 \quad (\text{1.VI.b})$$

The solution of equation (1.VI.b) are  $-2$ , and  $-5$ . Thus, the solution is

$$u = k_1 e^{-2t} + k_2 e^{-5t} \quad (\text{1.VI.c})$$

---

End Solution

---

#### A.2.4.1 Non-Homogeneous Second ODE

Homogeneous equation are equations that equal to zero. This fact can be used to solve non-homogeneous equation. Equations that not equal to zero in this form

$$a \frac{d^2u}{dt^2} + b \frac{du}{dt} + cu = l(x) \quad (\text{A.75})$$

The solution of the homogeneous equation is zero that is the operation  $L(u_h) = 0$ , where  $L$  is Linear operator. The additional solution of  $L(u_p)$  is the total solution as

$$L(u_{total}) = \overbrace{L(u_h)}^{=0} + L(u_p) \implies u_{total} = u_h + u_p \quad (\text{A.76})$$

Where the solution  $u_h$  is the solution of the homogeneous solution and  $u_p$  is the solution of the particular function  $l(x)$ . If the function on the right hand side is polynomial than the solution is will

$$u_{total} = u_h + \sum_{i=1}^n u_{p_i} \quad (\text{A.77})$$

The linearity of the operation creates the possibility of adding the solutions.

Example A.7:

Solve the non-homogeneous equation

$$\frac{d^2u}{dt^2} - 5 \frac{du}{dt} + 6u = t + t^2$$

SOLUTION

The homogeneous solution is

$$u(t) = c_1 e^{2t} + c_2 e^{3t} \quad (1.VII.a)$$

the particular solution for  $t$  is

$$u(t) = \frac{6t + 5}{36} \quad (1.VII.b)$$

and the particular solution of the  $t^2$  is

$$u(t) = \frac{18t^2 + 30t + 19}{108} \quad (1.VII.c)$$

The total solution is

$$u(t) = c_1 e^{2t} + c_2 e^{3t} + \frac{9t^2 + 24t + 17}{54} \quad (1.VII.d)$$

---

End Solution

---

## A.2.5 Non-Linear Second Order Equations

Some of the techniques that were discussed in the previous section (first order ODE) can be used for the second order ODE such as the variable separation.

### A.2.5.1 Segregation of Derivatives

If the second order equation

$$f(u, \dot{u}, \ddot{u}) = 0$$

can be written or presented in the form

$$f_1(u)\dot{u} = f_2(\dot{u})\ddot{u} \quad (A.78)$$

then the equation (A.78) is referred to as a separable equation (some called it segregated equations). The derivative of  $\dot{u}$  can be treated as a new function  $v$  and  $\dot{v} = \ddot{u}$ . Hence, equation (A.78) can be integrated

$$\int_{u_0}^u f_1(u)\dot{u} = \int_{\dot{u}_0}^{\dot{u}} f_2(\dot{u})\ddot{u} = \int_{v_0}^v f_2(v)\dot{v} \quad (A.79)$$



The integration results in a first order differential equation which should be dealt with the previous methods. It can be noticed that the function initial condition is used twice; first with initial integration and second with the second integration. Note that the derivative initial condition is used once. The physical reason is that the equation represents a strong effect of the function at a certain point such surface tension problems. This equation family is not well discussed in mathematical textbooks<sup>6</sup>.

**Example A.8:**

*Solve the equation*

$$\sqrt{u} \frac{du}{dt} - \sin\left(\frac{du}{dt}\right) \frac{d^2u}{dt^2} = 0$$

*With the initial condition of  $u(0) = 0$  and  $\frac{du}{dt}(t=0) = 0$  What happen to the extra "dt"?*

SOLUTION

Rearranging the ODE to be

$$\sqrt{u} \frac{du}{dt} = \sin\left(\frac{du}{dt}\right) \frac{d}{dt} \left(\frac{du}{dt}\right) \quad (1.VIII.a)$$

Thus the extra  $dt$  is disappeared and equation (1.VIII.a) becomes

$$\int \sqrt{u} du = \int \sin\left(\frac{du}{dt}\right) d\left(\frac{du}{dt}\right) \quad (1.VIII.b)$$

and transformation to  $v$  is

$$\int \sqrt{u} du = \int \sin(v) dv \quad (1.VIII.c)$$

After the integration equation (1.VIII.c) becomes

$$\frac{2}{3} \left(u^{\frac{3}{2}} - u_0^{\frac{3}{2}}\right) = \cos(v_0) - \cos(v) = \cos\left(\frac{du_0}{dt}\right) - \cos\left(\frac{du}{dt}\right) \quad (1.VIII.d)$$

Equation (1.VIII.d) can be rearranged as

$$\frac{du}{dt} = \arcsin\left(\frac{2}{3} \left(u_0^{\frac{3}{2}} - u^{\frac{3}{2}}\right) + \cos(v_0)\right) \quad (A.80)$$

Using the first order separation method yields

$$\int_0^t dt = \int_{u_0}^u \frac{du}{\arcsin\left(\frac{2}{3} \left(\underbrace{u_0^{\frac{3}{2}}}_{=0} - \underbrace{u^{\frac{3}{2}}}_{=1}\right) + \cos(v_0)\right)} \quad (A.81)$$

<sup>6</sup>This author worked (better word toyed) in (with) this area during his master but to his shame he did not produce any papers on this issue. The papers are still his drawer and waiting to a spare time.

The solution (A.81) shows that initial condition of the function is used twice while the initial of the derivative is used only once.

---

End Solution

---

### A.2.5.2 Full Derivative Case Equations

Another example of special case or families of second order differential equations which is results of the energy integral equation derivations as

$$u - a u \left( \frac{du}{dt} \right) \left( \frac{d^2u}{dt^2} \right) = 0 \quad (\text{A.82})$$

where  $a$  is constant. One solution is  $u = k_1$  and the second solution is obtained by solving

$$\frac{1}{a} = \left( \frac{du}{dt} \right) \left( \frac{d^2u}{dt^2} \right) \quad (\text{A.83})$$

The transform of  $v = \frac{du}{dt}$  results in

$$\frac{1}{a} = v \frac{dv}{dt} \implies \frac{dt}{a} = v dv \quad (\text{A.84})$$

which can be solved with the previous methods.

Bifurcation to two solutions leads

$$\frac{t}{a} + c = \frac{1}{2} v^2 \implies \frac{du}{dt} = \pm \sqrt{\frac{2t}{a} + c_1} \quad (\text{A.85})$$

which can be integrated as

$$u = \int \pm \sqrt{\frac{2t}{a} + c_1} dt = \pm \frac{a}{3} \left( \frac{2t}{a} + c_1 \right)^{\frac{3}{2}} + c_2 \quad (\text{A.86})$$

### A.2.5.3 Energy Equation ODE

It is non-linear because the second derivative is square and the function multiply the second derivative.

$$u \left( \frac{d^2u}{dt^2} \right) + \left( \frac{du}{dt} \right)^2 = 0 \quad (\text{A.87})$$

It can be noticed that that  $c_2$  is actually two different constants because the plus minus signs.

$$\frac{d}{dt} \left( u \frac{du}{dt} \right) = 0 \quad (\text{A.88})$$

after integration

$$u \frac{du}{dt} = k_1 \quad (\text{A.89})$$

Further rearrangement and integration leads to the solution which is

$$\frac{u^2}{2k_1} = t + k_2 \quad (\text{A.90})$$

For non-homogeneous equation they can be integrated as well.

Example A.9:

Show that the solution of

$$u \left( \frac{d^2u}{dt^2} \right) + \left( \frac{du}{dt} \right)^2 + u = 0 \quad (\text{1.IX.a})$$

is

$$-\frac{\sqrt{3} \int \frac{u}{\sqrt{3k_1 - u^3}} du}{\sqrt{2}} = t + k_2 \quad (\text{1.IX.b})$$

$$\frac{\sqrt{3} \int \frac{u}{\sqrt{3k_1 - u^3}} du}{\sqrt{2}} = t + k_2 \quad (\text{1.IX.c})$$

### A.2.6 Third Order Differential Equation

There are situations where fluid mechanics<sup>7</sup> leads to third order differential equation. This kind of differential equation has been studied in the last 30 years to some degree. The solution to constant coefficients is relatively simple and will be presented here. Solution to more complicate linear equations with non constant coefficient (function of  $t$ ) can be solved sometimes by Laplace transform or reduction of the equation to second order Olivier Vallee<sup>8</sup>.

The general form for constant coefficient is

$$\frac{d^3u}{dt^3} + a \frac{d^2u}{dt^2} + b \frac{du}{dt} + cu = 0 \quad (\text{A.91})$$

The solution is assumed to be of the form of  $e^{st}$  which general third order polonium. Thus, the general solution is depend on the solution of third order polonium. Third

<sup>7</sup>The unsteady energy equation in accelerated coordinate leads to a third order differential equation.

<sup>8</sup>“On the linear third-order differential equation” Springer Berlin Heidelberg, 1999. Solving Third Order Linear Differential Equations in Terms of Second Order Equations Mark van Hoeij

order polonium has always one real solution. Thus, derivation of the leading equation (results of the ode) is reduced into quadratic equation and thus the same situation exist.

$$s^3 + a_1 s^2 + a_2 s + a_3 = 0 \quad (\text{A.92})$$

The solution is

$$s_1 = -\frac{1}{3}a_1 + (S + T) \quad (\text{A.93})$$

$$s_2 = -\frac{1}{3}a_1 - \frac{1}{2}(S + T) + \frac{1}{2}i\sqrt{3}(S - T) \quad (\text{A.94})$$

and

$$s_3 = -\frac{1}{3}a_1 - \frac{1}{2}(S + T) - \frac{1}{2}i\sqrt{3}(S - T) \quad (\text{A.95})$$

Where

$$S = \sqrt[3]{R + \sqrt{D}}, \quad (\text{A.96})$$

$$T = \sqrt[3]{R - \sqrt{D}} \quad (\text{A.97})$$

and where the  $D$  is defined as

$$D = Q^3 + R^2 \quad (\text{A.98})$$

and where the definitions of  $Q$  and  $R$  are

$$Q = \frac{3a_2 - a_1^2}{9} \quad (\text{A.99})$$

and

$$R = \frac{9a_1a_2 - 27a_3 - 2a_1^3}{54} \quad (\text{A.100})$$

Only three roots can exist for the Mach angle,  $\theta$ . From a mathematical point of view, if  $D > 0$ , one root is real and two roots are complex. For the case  $D = 0$ , all the roots are real and at least two are identical. In the last case where  $D < 0$ , all the roots are real and unequal.

When the characteristic equation solution has three different real roots the solution of the differential equation is

$$u = c_1 e^{s_1 t} + c_2 e^{s_2 t} + c_3 e^{s_3 t} \quad (\text{A.101})$$

In the case the solution to the characteristic has two identical real roots

$$u = (c_1 + c_2 t) e^{s_1 t} + c_3 e^{s_2 t} \quad (\text{A.102})$$

Similarly derivations for the case of three identical real roots. For the case of only one real root, the solution is

$$u = (c_1 \sin b_1 + c_2 \cos b_1) e^{a_1 t} + c_3 e^{s_3 t} \quad (\text{A.103})$$

Where  $a_1$  is the real part of the complex root and  $b_1$  imaginary part of the root.

### A.2.7 Forth and Higher Order ODE

The ODE and partial differential equations (PDE) can be of any integer order. Sometimes the ODE is fourth order or higher the general solution is based in idea that equation is reduced into a lower order. Generally, for constant coefficients ODE can be transformed into multiplication of smaller order linear operations. For example, the equation

$$\frac{d^4 u}{dt^4} - u = 0 \implies \left( \frac{d^4}{dt^4} - 1 \right) u = 0 \quad (\text{A.104})$$

can be written as combination of

$$\left( \frac{d^2}{dt^2} - 1 \right) \left( \frac{d^2}{dt^2} + 1 \right) u = 0 \quad \text{or} \quad \left( \frac{d^2}{dt^2} + 1 \right) \left( \frac{d^2}{dt^2} - 1 \right) u = 0 \quad (\text{A.105})$$

The order of operation is irrelevant as shown in equation (A.105). Thus the solution of

$$\left( \frac{d^2}{dt^2} + 1 \right) u = 0 \quad (\text{A.106})$$

with the solution of

$$\left( \frac{d^2}{dt^2} - 1 \right) u = 0 \quad (\text{A.107})$$

are the solutions of (A.104). The solution of equation (A.106) and equation (A.107) was discussed earlier.

The general procedure is based on the above concept but is some what simpler. Inserting  $e^{s t}$  into the ODE

$$a_n u^{(n)} + a_{n-1} u^{(n-1)} + a_{n-2} u^{(n-2)} + \dots + a_1 u' + a_0 u = 0 \quad (\text{A.108})$$

yields characteristic equation

$$a_n s^n + a_{n-1} s^{n-1} + a_{n-2} s^{n-2} + \dots + a_1 s + a_0 = 0 \quad (\text{A.109})$$

If The Solution of Characteristic Equation	The Solution of Differential Equation Is
all roots are real and different e.g. $s_1 \neq s_2 \neq s_3 \neq s_4 \cdots \neq s_n$	$u = c_1 e^{s_1 t} + c_2 e^{s_2 t} + \cdots + c_n e^{s_n t}$
all roots are real but some are identical e.g. $s_1 = s_2 = \cdots = s_k$ and some different e.g. $s_{k+1} \neq s_{k+2} \neq s_{k+3} \cdots \neq s_n$	$u = (c_1 + c_2 t + \cdots + c_k t^{k-1}) e^{s_1 t} + c_{k+1} e^{s_{k+1} t} + c_{k+2} e^{s_{k+2} t} + \cdots + c_n e^{s_n t}$
$k/2$ roots, are pairs of conjugate complex numbers of $s_i = a_i \pm b_i$ and some real and different e.g. $s_{k+1} \neq s_{k+2} \neq s_{k+3} \cdots \neq s_n$	$u = (\cos(b_1 t) + \sin(b_1 t)) e^{a_1 t} + \cdots + (\cos(b_i t) + \sin(b_i t)) e^{a_i t} + \cdots + (\cos(b_k t) + \sin(b_k t)) e^{a_k t} + c_{k+1} e^{s_{k+1} t} + c_{k+2} e^{s_{k+2} t} + \cdots + c_n e^{s_n t}$
$k/2$ roots, are pairs of conjugate complex numbers of $s_i = a_i \pm b_i$ , $\ell$ roots are similar and some real and different e.g. $s_{k+1} \neq s_{k+2} \neq s_{k+3} \cdots \neq s_n$	$u = (\cos(b_1 t) + \sin(b_1 t)) e^{a_1 t} + \cdots + (\cos(b_i t) + \sin(b_i t)) e^{a_i t} + \cdots + (\cos(b_k t) + \sin(b_k t)) e^{a_k t} + (c_{k+1} + c_{k+2} t + \cdots + c_{k+\ell} t^{\ell-1}) e^{s_{k+1} t} + c_{k+2} e^{s_{k+2} t} + c_{k+3} e^{s_{k+3} t} + \cdots + c_n e^{s_n t}$

Example A.10:

Solve the fifth order ODE

$$\frac{d^5 u}{dt^5} - 11 \frac{d^4 u}{dt^4} + 57 \frac{d^3 u}{dt^3} - 149 \frac{d^2 u}{dt^2} + 192 \frac{du}{dt} - 90 u = 0 \quad (1.X.a)$$

#### SOLUTION

The characteristic equation is

$$s^5 - 11 s^4 + 57 s^3 - 149 s^2 + 192 s - 90 = 0 \quad (1.X.b)$$

With the roots of the equation (1.X.b) (these roots can be found using numerical methods or Descartes' Rule) are

$$\begin{aligned} s_{1,2} &= 3 \pm 3i \\ s_{3,4} &= 2 \pm i \\ s_5 &= 1 \end{aligned} \quad (1.X.c)$$

The roots are two pairs of complex numbers and one real number. Thus the solution is

$$u = c_1 e^t + e^{2t} (c_2 \sin(t) + c_3 \cos(t)) + e^{3t} (c_4 \sin(3t) + c_5 \cos(3t)) \quad (1.X.d)$$

### A.2.8 A general Form of the Homogeneous Equation

The homogeneous equation can be generalized to

$$k_0 t^n \frac{d^n u}{dt^n} + k_1 t^{n-1} \frac{d^{n-1} u}{dt^{n-1}} + \cdots + k_{n-1} t \frac{du}{dt} + k_n u = a x \quad (\text{A.110})$$

To be continue

## A.3 Partial Differential Equations

Partial Differential Equations (PDE) are differential equations which include function includes the partial derivatives of two or more variables. Example of such equation is

$$F(u_t, u_x, \dots) = 0 \quad (\text{A.111})$$

Where subscripts refers to derivative based on it. For example,  $u_x = \frac{\partial u}{\partial x}$ . Note that partial derivative also include mix of derivatives such as  $u_{xy}$ . As one might expect PDE are harder to solve.

Many situations in fluid mechanics can be described by PDE equations. Generally, the PDE solution is done by transforming the PDE to one or more ODE. Partial differential equations are categorized by the order of highest derivative. The nature of the solution is based whether the equation is elliptic parabolic and hyperbolic. Normally, this characterization is done for for second order. However, sometimes similar definition can be applied for other order. The physical meaning of the these definition is that these equations have different characterizations. The solution of elliptic equations depends on the boundary conditions The solution of parabolic equations depends on the boundary conditions but as well on the initial conditions. The hyperbolic equations are associated with method of characteristics because physical situations depends only on the initial conditions. The meaning for initial conditions is that of solution depends on some early points of the flow (the solution). The general second-order PDE in two independent variables has the form

$$a_{xx} u_{xx} + 2a_{xy} u_{xy} + a_{yy} u_{yy} + \cdots = 0 \quad (\text{A.112})$$

The coefficients  $a_{xx}$ ,  $a_{xy}$ ,  $a_{yy}$  might depend upon "x" and "y". Equation (A.112) is similar to the equations for a conic geometry:

$$a_{xx} x^2 + a_{xy} x y + a_{yy} y^2 + \cdots = 0 \quad (\text{A.113})$$

In the same manner that conic geometry equations are classified are based on the discriminant  $a_{xy}^2 - 4a_{xx} a_{yy}$ , the same can be done for a second-order PDE. The discriminant can be function of the  $x$  and  $y$  and thus can change sign and thus the characteristic of the equation. Generally, when the discriminant is zero the equation are called parabolic. One example of such equation is heat equation. When the discriminant

is larger than zero the equation is referred to as hyperbolic equations. In fluid mechanics this kind of equation appears in supersonic flow or in subcritical flow in open channel flow. The equations not mentioned above are elliptic which appear in ideal flow and subsonic flow and subcritical open channel flow.

### A.3.1 First-order equations

First order equation can be written as

$$u = a_x \frac{\partial u}{\partial x} + a_y \frac{\partial u}{\partial y} + \dots \quad (\text{A.114})$$

The interpretation of the equation characteristic is complicated. However, the physics dictates this character and will be used in the book.

An example of first order equation is

$$\frac{\partial u}{\partial x} + \frac{\partial u}{\partial y} = 0 \quad (\text{A.115})$$

The solution is assumed to be  $u = Y(y)X(x)$  and substitute into the (A.115) results in

$$Y(y) \frac{\partial X(x)}{\partial x} + X(x) \frac{\partial Y(y)}{\partial y} = 0 \quad (\text{A.116})$$

Rearranging equation (A.116) yields

$$\frac{1}{X(x)} \frac{\partial X(x)}{\partial x} + \frac{1}{Y(y)} \frac{\partial Y(y)}{\partial y} = 0 \quad (\text{A.117})$$

A possible way the equation (A.117) can exist is that these two terms equal to a constant. Is it possible that these terms not equal to a constant? The answer is no if the assumption of the solution is correct. If it turned out that assumption is wrong the ratio is not constant. Hence, the constant is denoted as  $\lambda$  and with this definition the PDE is reduced into two ODE. The first equation is  $X$  function

$$\frac{1}{X(x)} \frac{\partial X(x)}{\partial x} = \lambda \quad (\text{A.118})$$

The second ODE is for  $Y$

$$\frac{1}{Y(y)} \frac{\partial Y(y)}{\partial y} = -\lambda \quad (\text{A.119})$$

Equations (A.119) and (A.118) are ODE that can be solved with the methods described before for certain boundary condition.



## A.4 Trigonometry

These trigonometrical identities were set up by Keone Hon with slight modification

$$1. \sin(\alpha + \beta) = \sin \alpha \cos \beta + \sin \beta \cos \alpha$$

$$2. \sin(\alpha - \beta) = \sin \alpha \cos \beta - \sin \beta \cos \alpha$$

$$3. \cos(\alpha + \beta) = \cos \alpha \cos \beta - \sin \alpha \sin \beta$$

$$4. \cos(\alpha - \beta) = \cos \alpha \cos \beta + \sin \alpha \sin \beta$$

$$5. \tan(\alpha + \beta) = \frac{\tan \alpha + \tan \beta}{1 - \tan \alpha \tan \beta}$$

$$6. \tan(\alpha - \beta) = \frac{\tan \alpha - \tan \beta}{1 + \tan \alpha \tan \beta}$$

$$1. \sin 2\alpha = 2 \sin \alpha \cos \alpha$$

$$2. \cos 2\alpha = \cos^2 \alpha - \sin^2 \alpha = 2 \cos^2 \alpha - 1 = 1 - 2 \sin^2 \alpha$$

$$3. \tan 2\alpha = \frac{2 \tan \alpha}{1 - \tan^2 \alpha}$$

$$4. \sin \frac{\alpha}{2} = \pm \sqrt{\frac{1 - \cos \alpha}{2}} \text{ (determine whether it is + or - by finding the quadrant that } \frac{\alpha}{2} \text{ lies in)}$$

$$5. \cos \frac{\alpha}{2} = \pm \sqrt{\frac{1 + \cos \alpha}{2}} \text{ (same as above)}$$

$$6. \tan \frac{\alpha}{2} = \frac{1 - \cos \alpha}{\sin \alpha} = \frac{\sin \alpha}{1 + \cos \alpha}$$

for formulas 3-6, consider the triangle with sides of length  $a$ ,  $b$ , and  $c$ , and opposite angles  $\alpha$ ,  $\beta$ , and  $\gamma$ , respectively

$$1. \sin^2 \alpha = \frac{1 - 2 \cos(2\alpha)}{2}$$

$$2. \cos^2 \alpha = \frac{1 + 2 \cos(2\alpha)}{2}$$

$$3. \frac{\sin \alpha}{a} = \frac{\sin \beta}{b} = \frac{\sin \gamma}{c} \text{ (Law of Sines)}$$

$$4. c^2 = a^2 + b^2 - 2ab \cos \gamma \text{ (Law of Cosines)}$$

$$5. \text{Area of triangle} = \frac{1}{2}ab \sin \gamma$$

$$6. \text{Area of triangle} = \sqrt{s(s-a)(s-b)(s-c)},$$

where  $s = \frac{a+b+c}{2}$  (Heron's Formula)

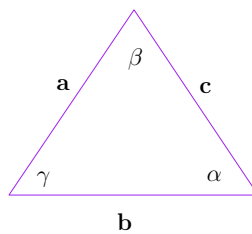

Fig. -A.7. The triangle angles sides.



## Subjects Index

### Symbols

$\pi$ -theory, 273

### A

absolute viscosity, 7, 8, 11, 12  
 Accelerated system, 93  
 Acceleration direct derivative, 240  
 Acceleration, angular, 95  
 Add Force, 228  
 Add mass, 188, 228  
 Add momentum, 188  
 adiabatic nozzle, 387  
 Aeronautics, 4  
 angle of attack, 527  
 Arc shape, 112  
 Archimedes, 3  
 Archimedes number, 309  
 Area direction, 5  
 Atmospheric pressure, 75  
 Atwood number, 309  
 Averaged kinetic energy, 203  
 Averaged momentum energy, 203  
 Averaged momentum velocity, 176  
 Averaged velocity  
   concentric cylinders, 266  
   Correction factor, 203  
   Integral Analysis, 188  
   Integral analysis, 190  
 Avi number, 306

### B

Basic units, 282  
 Bernoulli's equation, 209, 217, 379  
 Bingham's model, 11  
 Body force, 69, 70, 72, 88, 90  
   effective, 71  
 Bond number, 309  
 Boundary Layer, 161  
 Brinkman number, 309  
 Buckingham's theorem, 280  
 Bulk modulus, 311  
 bulk modulus, 24, 26

Bulk modulus of mixtures, 29  
 buoyancy, 3, 117, 118  
 buoyant force, 88, 127

### C

Capillary number, 313  
 Capillary numbers, 309  
 Cauchy number, 309  
 Cauchy–Riemann equation, 339  
 Cavitation number, 309  
 Choking flow, 377  
 Circulation Concept, 346  
 Co-current flow, 539  
 Complex Potential, 369  
 Complex Velocity, 369  
 Complex velocity, 370  
 Compressibility factor, 79, 92  
 Compressible Flow, 377  
 Compressible flow, 377  
 Concentrating surfaces raise, 34  
 Conduction, 198  
 Conservative force, 213  
 Convection, 198  
 Convective acceleration, 240  
 converging–diverging nozzle, 384  
 Correction factor, 87  
 Counter-current  
   Pulse flow, 556  
 Counter-current flow, 539, 555  
   Annular flow, 556  
   Extended Open channel flow, 557  
 Courant number, 309  
 Cut-out shapes, 111  
 Cylindrical Coordinates, 229  
 Cylindrical coordinates  
   stream + potential function, 355

### D

D'Alembert paradox, 4  
 D'Alembert's paradox, 363  
 d'Alembert's Paradox, 526  
 d'Alembertian Operator, 571

- Darcy friction factor, 422
  - Dean number, 309
  - Deborah number, 309
  - deflection angle, 486
  - deflection angle range, 501
  - Deformable control volume, 148
  - Density, 6
    - definition, 6
  - Density ratio, 88, 131
  - detached shock, 505
  - Differential analysis, 227
  - dilettante, 11
  - Dimension matrix, 293
  - Dimensional analysis, 273
    - Basic units, 275
    - Parameters, 277
    - Typical parameters, 308
  - Dimensional matrix, 287
  - Dimensionless
    - Naturally, 283
  - Dipole Flow, 354
  - Discontinuity, 377
  - Divergence Theorem, 572
  - Double choking phenomenon, 541
  - Doublet flow, 349
  - Drag coefficient, 309
  - Dynamics similarity, 295
- E**
- Eckert number, 309
  - Ekman number, 310
  - Energy conservation, 197
  - Energy Equation
    - Linear accelerate System, 213
    - Rotating Coordinate System, 215
    - Accelerated System, 213
  - Energy equation
    - Frictionless Flow, 212
    - Simplified equations, 216
    - Steady State, 211
  - Euler equations, 227
  - Euler number, 310, 314
  - Existences of stream function, 341
  - External forces, 174
- F**
- Fanning Friction factor, 422
  - fanno
    - second law, 438
  - Fanno flow
    - Maximum length, 451
  - fanno flow, 436,  $\frac{4fL}{D}$  440
    - choking, 441
    - average friction factor, 442
    - entrance Mach number calculations, 450, 466
    - entropy, 440
    - shockless, 448
    - star condition, 443
  - Fanno flow trends, 441
  - First Law of Thermodynamics, 197
  - Fixed fluidized bed, 553
  - Fliegner number, 396
  - Flow first mode, 264
  - Flow out tank, 200
  - Flow rate
    - concentric cylinders, 266
  - Flow regime map, 536
  - Flow regimes in one pipe, 540
  - Fluid Statics
    - Geological system, 97
  - Fluids
    - kinds gas, liquid, 5
  - Forces
    - Curved surfaces, 109
  - Fourier law, 198
  - Free expansion, 88–90
  - Free Vortex, 345
  - Froude number, 310
    - rotating, 315
  - Fully fluidized bed, 553
- G**
- Galileo number, 310, 315
  - Gas dynamics, 4
  - Gas–gas flow, 538
  - Gauss-Ostrogradsky Theorem, 572
  - Geometric similarity, 294
  - Grashof number, 310
  - Gravity varying

Ideal gas, 91  
Real gas, 91

**H**

Harmonic function, 572  
horizontal counter-current flow, 557  
Horizontal flow, 539  
Hydraulic Jump, *see* discontinuity  
Hydraulics, 4  
Hydraulics system, 30  
Hydrodynamics, 4  
Hydrostatic pressure, 69, 113

**I**

Ideal gas, 79  
Impulse function, 403  
Inclined manometer, 78  
Indexical form, 279  
Initial condition, 579  
Integral analysis  
    big picture, 166  
    small picture, 166  
Integral equation, 83  
Interfacial instability, 228  
Inverted manometer, 78  
isothermal flow  
    entrance issues, 426  
    entrance length limitation, 426  
    maximum  $\frac{4fL}{D}$ , 425  
    table, 429  
Isotropic viscosity, 248

**K**

Kinematic, 3  
Kinematic boundary condition, 257  
Kinematic similarity, 295  
kinematic viscosity, 11  
Kolmogorov time, 311  
Kutta-Joukowski theorem, 368

**L**

Laplace Constant, 310  
Laplace number, 315  
Lapse rate, 90  
large deflection angle, 492

Leibniz integral rule, 158  
Lift coefficient, 310  
Limitation of the integral approach, 209  
line of characteristic, 523  
Linear acceleration, 93  
Linear operations, 578  
Liquid phase, 81  
Liquid-Liquid Regimes, 538  
Local acceleration, 240  
Lockhart martinelli model, 550  
Long pipe flow, 421

**M**

Mach angle, 383  
Mach cone, 383  
Mach number, 310, 385  
"Magnification factor", 78  
Marangoni number, 310  
Mass velocity, 544  
maximum deflection angle, 495  
maximum turning angle, 526  
Metacentric point, 128  
Micro fluids, 254  
Minimum velocity solid-liquid flow, 552  
Mixed fluidized bed, 553  
Momentum Conservation, 173  
Momentum conservation, 241  
Momentum equation  
    Accelerated system, 175  
    index notation, 246  
Morton number, 310  
Moving boundary, 256  
Moving surface  
    Free surface, 257  
Moving surface, constant of integration,  
    258  
Multi-phase flow, 535  
Multiphase flow against the gravity, 542

**N**

NACA 1135, 486  
Navier Stokes equations  
    solution, 4  
Navier-Stokes equations, 227, 296  
Negative deflection angle, 486

- Neutral moment
    - Zero moment, 127
  - Neutral stable, 90, 127, 139, 140
  - Newtonian fluids, 1, 8
  - No-slip condition, 256
  - Non-deformable control volume, 148
  - Non-Linear Equations, 581
  - normal components, 487
  - Normal Shock
    - Solution, 410
  - Normal stress, 248
  - Nusselt number, 305
  - Nusselt's dimensionless technique, 298
- O**
- Oblique shock, 485
  - oblique shock
    - conditions for solution, 491
    - normal shock, 485
    - Prandtl-Meyer function, 485
  - oblique shock governing equations, 488
  - Ohnesorge number, 315
  - Open channel flow, 539
  - Orthogonal Coordinates, 573
  - Oscillating manometer, 210
  - Ozer number, 310
- P**
- Pendulum action, 137
  - Pendulum problem, 278
  - perpendicular components, 487
  - Piezometric pressure, 72
  - Pneumatic conveying, 553
  - Poiseuille flow, 262
    - Concentric cylinders, 264
  - Polynomial function, 114
  - Potential flow, 332
  - Potential Flow Functions, 342
  - Prandtl number, 311
  - Prandtl-Meyer flow, 520
  - Prandtl-Meyer function
    - small angle, 520
    - tangential velocity, 523
  - Pressure center, 106
  - pseudoplastic, 11
  - Pulse flow, 556
  - purely viscous fluids, 11
  - Pushka equation, 27, 92, 99
    - expansion, 97
- R**
- Radiation, 198
  - Rayleigh Flow
    - negative friction, 471
  - Rayleigh flow, 471
    - second law, 474
    - tables, 475
    - two maximums, 473
  - rayleigh flow, 471
    - entrance Mach number, 481
  - Rayleigh-Taylor instability, 139, 539
  - Real gas, 79
  - Return path for flow regimes, 541
  - Reynolds number, 311, 312
  - Reynolds Transport Theorem, 158
    - Divergence Theorem, 572
  - Rocket mechanics, 184
  - Rossby number, 311
- S**
- Scalar function, 70, 109
  - Second Law of Thermodynamics, 212
  - Second viscosity coefficient, 253
  - Sector flow, 372
  - Segregated equations, 586
  - Sharp edge flow, 373
  - Shear number, 311
  - Shear stress
    - initial definition, 7
  - shear stress, 6
  - Shock
    - Limitations, 414
  - Shock angle, 490
  - shock wave, 406
    - star velocity, 411
    - table
      - basic, 418
      - trivial solution, 410
  - Similitude, 275, 294
  - Sink Flow, 343

Slip condition range, 256  
Solid–fluid flow  
    Gas dynamics aspects, 553  
Solid–fluid flow, 551  
Solid–liquid flow, 551  
Solid–solid flow, 538  
sonic transition, 391  
Source and sink flow, 349  
Source Flow, 343  
speed of sound  
    ideal gas, 380  
    liquid, 381  
    solid, 382  
    steam table, 381  
Speed of sound, what, 378  
Spherical coordinates, 92  
Spherical volume, 125  
Stability analysis, 88  
stability analysis, 90, 117  
    cubic, 127  
Stability in counter–current flow, 557  
Stable condition, 88, 136  
Stagnation state, 384  
Star conditions, 411  
Stokes number, 311  
stratified flow, 539  
Stream function, 334  
Stream Function Cylindrical Coordinates,  
    355  
Stress tensor, 242  
    Cartesian coordinates, 241  
    symmetry, 242, 244  
    transformation, 242  
strong solution, 492  
Strouhal number, 311  
substantial derivative, 240  
Superficial velocity, 540  
Superposition of flows, 348  
Sutherland's equation, 12

**T**  
Tank emptying parameters, 207  
Taylor number, 311  
Terminal velocity, 552  
Thermal pressure, 253

Thermodynamical pressure, 253  
thixotropic, 11  
throat area, 391  
Torricelli's equation, 209  
Total moment, 101  
Transformation matrix, 242  
Transition to continuous, 173  
Triangle shape, 112, 120  
Turbomachinery, 191  
Two–Phase  
    Gas superficial velocity, 545  
    Liquid holdup, 545  
    Quality of dryness, 545  
    Reversal flow, 558  
    Slip velocity, 545  
    Void Fraction, 545  
    Wetness fraction, 545

**U**

Uniform Flow, 342  
Unstable condition, 88  
Unsteady State Momentum, 183  
Upsteam Mach number, 500

**V**

Vapor pressure, 75  
Variables Separation  
    1st equation, 583  
Vectors, 567  
Vectors Algebra, 568  
Vertical counter–current flow, 556  
Vertical flow, 539  
Viscosity, 9  
von Karman vortex street, 312  
Vorticity, 330

**W**

Watson's method, 19  
Wave Operator, 571  
weak solution, 492  
Weber number, 311, 313  
Westinghouse patent, 538

**Y**

Young modulus, 311

Young's Modulus, 382

**Z**

zero deflection angle, 499

Zhukovsky, *see also* Joukowski



**Authors Index****B**

Bhuckingham, 4  
Blasiu, 4  
Blasius, 4  
Bossut, 4  
Brahms, 4  
Buckingham, 273, 275

**C**

Chezy, 4  
Cichilli, 549  
Coulomb, 4

**D**

d'Aubisson, 4  
Darcy, 4  
de Saint Venant, Barré, 227  
Dubuat, 4  
Duckler, 536, 549  
Dupuit, 4

**E**

Euler, 4  
Euler, Leonahard, 314  
Evangelista Torricelli, 209

**F**

Fabre, 4  
Fanning, 4  
Fourier Jean B. J., 274  
Froude, William, 4, 274

**G**

Ganguillet, 4  
Gauss, Carl Friedrich, 572

**H**

Hagen, 4  
Helmholtz, 4  
Helmholtz, Hermann von, 4  
Henderson, 508

**K**

Kelvin, 4  
Kirchhoff, 4  
Kutta, Martin Wilhelm, 368  
Kutta-Joukowski, 4

**L**

La Grange, 4  
Leibniz, 158  
Lockhart, 536

**M**

Manning, 4  
Martinelli, 274, 536  
Maxwell, 274  
Menikoff, 508  
Meye, 4  
Mikhail Vasilievich Ostrogradsky, 572

**N**

Navier, Claude–Louis, 227  
Newton, 274  
Nikuradse, 4  
Nusselt, Ernst Kraft Wilhelm, 266, 273,  
275

**O**

Olivier Vallee, 589

**P**

Pierre-Simon Laplace, 572  
Poiseuille, Jean Louis, 262  
Poisueille, 4  
Poisson, Simon-Denis, 227  
Prandtl, 4

**R**

Rankine, 4  
Rayleigh, 4, 139, 274  
Reiner, M., 311  
Reynolds, Osborne, 158, 275  
Riabouchunsky, 275  
Rose, 4

**S**

Schmidt, 273  
Smeaton, John, 274  
Stanton, 4  
Stokes, George Gabriel, 227  
Strouhal, Vincenz, 320

**T**

Taitle, 536  
Taylor, G.I., 139  
Thompson, 490  
Torricelli, Evangelista, 209

**V**

Vaschy, Aiméem, 274  
Von Karman, 4, 312

**W**

Weisbach, 4  
Westinghouse, 538

**Z**

Zhukovsky, Nikolay Yegorovich, 368