

IS-0024

भारतीय मानक  
Indian Standard

IS 11478 : 2018  
IEC/TR 60930 : 2008  
Merging of IS 11478 (Part 1) : 1985  
and IS 11478 (Part 2) : 1985

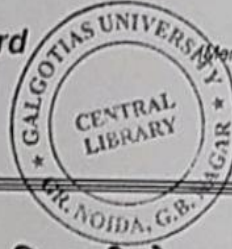

चिकित्सा बिजली के उपकरणों और  
चिकित्सा विद्युत प्रणालियों के सुरक्षित  
उपयोग से सम्बंधित प्रशासनिक, चिकित्सा,  
और नर्सिंग स्टाफ के लिए दिशानिर्देश  
( पहला पुनरीक्षण )

**Guidelines for Administrative,  
Medical, and Nursing Staff  
Concerned with the Safe Use of  
Medical Electrical Equipment  
and Medical Electrical Systems**  
( *First Revision* )

ICS 11.040

© BIS 2018



भारतीय मानक ब्यूरो  
BUREAU OF INDIAN STANDARDS  
मानक भवन, 9 बहादुरशाह ज़फर मार्ग, नई दिल्ली-110002  
MANAK BHAVAN, 9 BAHADUR SHAH ZAFAR MARG  
NEW DELHI-110002  
[www.bis.gov.in](http://www.bis.gov.in) [www.standardsbis.in](http://www.standardsbis.in)

August 2018

Price Group 9

## CONTENTS

NATIONAL FOREWORD.....	iii
INTRODUCTION.....	iv
1 Scope.....	1
2 Normative references .....	1
3 Terms and definitions .....	2
4 Nature of HAZARDS.....	2
5 BASIC SAFETY provisions of and symbols on ME EQUIPMENT.....	2
5.1 General .....	2
5.2 ACCOMPANYING DOCUMENTS.....	2
5.3 Colours of indicator lights.....	3
5.4 Markings on ME EQUIPMENT.....	3
5.5 Protection against electric shock .....	3
5.5.1 Method of protection for ME EQUIPMENT .....	3
5.5.2 Degree of protection of APPLIED PARTS .....	4
5.5.3 ME EQUIPMENT not properly marked.....	5
5.6 Protection against mechanical HAZARDS.....	5
5.6.1 Protection of PATIENTS, OPERATORS and others from suspended or moving masses.....	5
5.6.2 Stability .....	5
5.6.3 Protection against rough handling.....	5
6 Protection against thermal HAZARDS and fire prevention.....	6
6.1 APPLIED PARTS not intended to supply heat to the PATIENT.....	6
6.2 Protection against ignition in medical locations.....	6
7 Protection against unwanted or excessive radiation.....	6
8 ALARM SYSTEMS.....	6
8.1 General .....	6
8.2 ALARM CONDITION priorities.....	7
8.3 Visual ALARM SIGNALS .....	8
8.4 Auditory ALARM SIGNALS .....	8
9 BASIC SAFETY provisions for ME SYSTEMS.....	8
9.1 General .....	8
9.2 ACCOMPANYING DOCUMENTS.....	9
9.3 PATIENT ENVIRONMENT.....	9
9.4 MULTIPLE SOCKET-OUTLET (MSO).....	9
10 Protection against ingress of water or particulate matter.....	10
11 Cleaning, disinfection and sterilization.....	11
12 Electromagnetic phenomena .....	11
12.1 General recommendations.....	11
12.2 Identification, marking and documents.....	12
12.2.1 Marking on the outside of ME EQUIPMENT or ME EQUIPMENT parts .....	12
12.2.2 ACCOMPANYING DOCUMENTS.....	12
13 Electrical installations in medical locations .....	13
14 Purchasing and MAINTENANCE of equipment, training of personnel .....	13
14.1 Accountability.....	13
14.2 Purchasing .....	13

IS 11478 : 2018

IEC/TR 60930 : 2008

14.3 Delivery and commissioning .....	14
14.4 Training .....	15
14.5 MAINTENANCE .....	15
14.5.1 Concepts .....	15
14.5.2 MAINTENANCE programme .....	16
14.6 Checking of the installation and selection of the ME EQUIPMENT or ME SYSTEM .....	16
14.6.1 Installation .....	16
14.6.2 Verification of equipment safety .....	16
14.6.3 Single items of ME EQUIPMENT .....	16
14.6.4 Combinations of ME EQUIPMENT .....	16
14.6.5 Connection of ME EQUIPMENT or an ME SYSTEM to the health care facilities' data network .....	16
15 Recommended practice .....	19
Annex A (informative) PATIENT ENVIRONMENT .....	20
Bibliography .....	21
Index of defined terms used in this technical report .....	21
Figure 1 – Symbols indicating the degree of protection provided by an APPLIED PART .....	4
Figure 2 – Symbols indicating the degree of protection against the effects of a discharge of a cardiac defibrillator .....	4
Figure 3 – Safety signs indicating a RISK from a person pushing, sitting or stepping on ME EQUIPMENT .....	5
Figure 4 – Symbols indicating the ME EQUIPMENT is designed to avoid ignition of FLAMMABLE ANAESTHETIC MIXTURE WITH AIR, or FLAMMABLE ANAESTHETIC MIXTURE WITH OXYGEN OR NITROUS OXIDE .....	6
Figure 5 – Example of the construction of a MULTIPLE SOCKET-OUTLET (MSO) .....	10
Figure A.1 – Example of PATIENT ENVIRONMENT .....	19
Table 1 – Colours of indicator lights and their meaning for ME EQUIPMENT .....	3
Table 2 – ALARM CONDITION priorities from IEC 60601-1-8:2006 .....	8
Table 3 – Characteristics of alarm indicator lights from IEC 60601-1-8:2006 .....	8

Electromedical, Diagnostic Imaging and Radiotherapy Equipment Sectional Committee, MHD 15

## NATIONAL FOREWORD

This Indian Standard (First Revision) which is identical with IEC/TR 60930 : 2008 'Guidelines for administrative, medical, and nursing staff concerned with the safe use of medical electrical equipment and medical electrical systems' issued by the International Electrotechnical Commission (IEC) was adopted by the Bureau of Indian Standards on the recommendation of the Electromedical, Diagnostic Imaging and Radiotherapy Equipment Sectional Committee and approval of the Medical Equipment and Hospital Planning Division Council.

This standard was first published in 1985 in two parts based on IEC document 'General guidelines for the safe application medical electrical equipment (technical application code)'. On availability of IEC/TR 60930 : 2008 on the subject this revision has been taken up to align it with the latest IEC Standard by adopting it identically and being published as a single standard by merging both the parts.

The text of IEC Standard has been approved as suitable for publication as an Indian Standard without deviations. Certain conventions are however not identical to those used in Indian Standards. Attention is particularly drawn to the following:

- a) Wherever the words 'International Standard' appear referring to this standard, they should be read as 'Indian Standard'.
- b) Comma (,) has been used as a decimal marker while in Indian Standards, the current practice is to use a point (.) as the decimal marker.

In this adopted standard, reference appears to the following International Standards for which Indian Standards also exists. The corresponding Indian Standards which are to be substituted in their places, are listed below along with their degree of equivalence for the editions indicated:

<i>International Standard</i>	<i>Corresponding Indian Standard</i>	<i>Degree of Equivalence</i>
IEC 60601-1 : 2005 Medical electrical equipment Part 1: General requirements for basic safety and essential performance	IS 13450 (Part 1) : 2018 Medical electrical equipment : Part 1 General requirements for basic safety and essential performance	Identical with IEC 60601-1 : 2012 (Ed 3.1)
IEC 60601-1-2 <sup>1)</sup> Medical electrical equipment — Part 1-2: General requirements for safety — Collateral standard: Electromagnetic compatibility — Requirements and tests	IS 13450 (Part 1/Sec 2) Medical electrical equipment : Part 1 General requirements for the safety, Section 2 Collateral standard: Electromagnetic disturbances — Requirements and tests ( <i>first revision</i> ) ( <i>under publication</i> )	Identical with IEC 60601-1-2 : 2014
IEC 62353 : 2007 Medical electrical equipment — Recurrent test and test after repair of medical electrical equipment	IS/IEC 62353 : 2007 Medical electrical equipment — Recurrent test and test after repair of medical electrical equipment	do

The technical committee has reviewed the provisions of the following International Standard referred in this adopted standard and has decided that it is acceptable for use in conjunction with this standard:

<i>International Standard</i>	<i>Title</i>
IEC 60601-1-8 : 2007	Medical electrical equipment Part 1-8: General requirements for basic safety and essential performance Collateral standard : General requirements, tests and guidance for alarm systems in medical electrical equipment and medical electrical systems

<sup>1)</sup> Since revised in 2014.

## INTRODUCTION

The amount of electrical equipment and the number of medical procedures employing MEDICAL ELECTRICAL EQUIPMENT or MEDICAL ELECTRICAL SYSTEMS continue to grow. In order to prevent accidents or near accidents such as burns, excessive radiation, electrical shock or even cardiac arrest, procedures should be available to handle the selection, installation, application and MAINTENANCE of MEDICAL ELECTRICAL EQUIPMENT and MEDICAL ELECTRICAL SYSTEMS by qualified personnel.

In order to establish a satisfactory level of BASIC SAFETY and performance for MEDICAL ELECTRICAL EQUIPMENT, MEDICAL ELECTRICAL SYSTEMS and electrical installations in medical locations, requirements for design and construction are specified in standards prepared by the IEC. These standards are intended to cover the design and construction of new equipment and installations (see the Bibliography). The requirements of these standards should also be met if the equipment or installation is REPAIRED or modified. IEC 60513 explains the basic aspects of safety philosophy.

The following guidelines are suggested:

- The MEDICAL ELECTRICAL EQUIPMENT or MEDICAL ELECTRICAL SYSTEM has to be safe, that is, built to the relevant IEC standards.
- The electrical installation in medical locations has to be safe, that is, in accordance with the relevant IEC standards or corresponding national regulations.
- The instructions for use have to be available at the site of use. The instructions for use, warning statements and markings on MEDICAL ELECTRICAL EQUIPMENT or a MEDICAL ELECTRICAL SYSTEM have to be written in a language acceptable to the OPERATOR.
- Besides their knowledge of the medical procedure, the OPERATORS need to know the BASIC SAFETY characteristics and performance of the MEDICAL ELECTRICAL EQUIPMENT or MEDICAL ELECTRICAL SYSTEM. This can be achieved by instruction and training under the supervision of the RESPONSIBLE ORGANIZATION) e.g. by the MANUFACTURER or the CLINICAL ENGINEERING DEPARTMENT of the health care facility.

NOTE 1 In IEC 60601-1:2005, the RESPONSIBLE ORGANIZATION is defined as the entity accountable for the use and maintenance of the ME EQUIPMENT or the ME SYSTEM. The accountable entity can be, for example, a hospital, an individual clinician or a lay person. In home use applications, the PATIENT, OPERATOR and RESPONSIBLE ORGANIZATION can be one and the same person. In earlier editions of IEC 60601-1, the RESPONSIBLE ORGANIZATION was referred to as the "user."

- The RESPONSIBLE ORGANIZATION and CLINICAL ENGINEERING DEPARTMENT have to ensure that BASIC SAFETY and performance, including the ESSENTIAL PERFORMANCE, of the MEDICAL ELECTRICAL EQUIPMENT or MEDICAL ELECTRICAL SYSTEM are maintained by an effective MAINTENANCE scheme. This can be achieved by an adequate MAINTENANCE programme and regular SERVICING performed by an appropriately staffed and organized CLINICAL ENGINEERING DEPARTMENT.

NOTE 2 This report contains a simplified explanation which is partly related to IEC 60513:1994, *Fundamental aspects of safety standards for medical electrical equipment*, and partly to IEC 60601-1:2005: *Medical electrical equipment, Part 1: General requirements for basic safety and essential performance*, IEC 60601-1-2:2007, *Medical electrical equipment - Part 1-2: General requirements for basic safety and essential performance - Collateral standard: Electromagnetic compatibility - Requirements and tests* and IEC 60601-1-8:2006, *Medical electrical equipment - Part 1-8: General requirements for basic safety and essential performance - Collateral Standard: General requirements, tests and guidance for alarm systems in medical electrical equipment and medical electrical systems*. Due to the nature of this report it is recommended that it be translated into the language spoken in each country. At the same time, National Committees are asked to go through the report thoroughly in order to amend the text to contain the special national requirements (e.g. depending on the electrical installations).

This technical report applies to MEDICAL ELECTRICAL EQUIPMENT, MEDICAL ELECTRICAL SYSTEMS and electrical installations in medical locations. The term "equipment" should be understood to mean MEDICAL ELECTRICAL EQUIPMENT or other electrical or non-electrical equipment in the context of a MEDICAL ELECTRICAL SYSTEM. That equipment will usually be electrically powered (i.e. connected to a SUPPLY MAINS or INTERNALLY POWERED). It can be assumed, however, that the approach to the subject in this report will generally be equally valid for medical equipment powered by other energy sources, such as compressed gases.

## *Indian Standard*

# GUIDELINES FOR ADMINISTRATIVE, MEDICAL, AND NURSING STAFF CONCERNED WITH THE SAFE USE OF MEDICAL ELECTRICAL EQUIPMENT AND MEDICAL ELECTRICAL SYSTEMS

*( First Revision )*

## 1 Scope

This technical report is intended to lessen the RISK to PATIENTS, OPERATORS, and their surroundings by providing a code of safe application. This reduction of RISK is in addition to that brought about by the RISK CONTROL measures incorporated in the MEDICAL ELECTRICAL EQUIPMENT, the MEDICAL ELECTRICAL SYSTEM, and the electrical installation in medical locations, hereafter referred to as ME EQUIPMENT, ME SYSTEM and installation respectively.

Not all existing ME EQUIPMENT, ME SYSTEMS or installations meet the requirements of the relevant IEC standards. From time to time, OPERATORS and RESPONSIBLE ORGANIZATIONS will encounter ME EQUIPMENT and ME SYSTEMS complying with older safety standards. However, the guidelines for safe application given in this technical report should nevertheless be followed in so far as this is possible.

The guidelines in this technical report can be used with ME EQUIPMENT or ME SYSTEMS for the home healthcare environment provided the MANUFACTURER has included home use in the INTENDED USE or the CLINICAL ENGINEERING DEPARTMENT has checked that the electrical installation and the physical environment will not result in any unacceptable RISKS. These guidelines can also be applied to equipment used for compensation or alleviation of disease, injury or disability.

If the ME EQUIPMENT, an ME SYSTEM or the installation does not comply with the relevant IEC standards, the RESPONSIBLE ORGANIZATION should consult with the CLINICAL ENGINEERING DEPARTMENT or the MANUFACTURER for instructions on how to achieve an adequate level of safety.

## 2 Normative references

The following referenced documents are indispensable for the application of this document. For dated references, only the edition cited applies. For undated references, the latest edition of the referenced document (including any amendments) applies.

IEC 60601-1:2005, *Medical electrical equipment – Part 1: General requirements for basic safety and essential performance*

IEC 60601-1-2:2007, *Medical electrical equipment – Part 1-2: General requirements for basic safety and essential performance – Collateral standard: Electromagnetic compatibility – Requirements and tests*

IEC 60601-1-8:2006, *Medical electrical equipment – Part 1-8: General requirements for basic safety and essential performance – Collateral Standard: General requirements, tests and guidance for alarm systems in medical electrical equipment and medical electrical systems*

IEC 62353:2007, *Medical electrical equipment – Recurrent test and test after repair of medical electrical equipment*

### 3 Terms and definitions

For the purposes of this document, the terms and definitions in IEC 60601-1:2005, IEC 60601-1-2:2007, IEC 60601-1-8:2006 and IEC 62353:2007 and the following term and definition apply.

NOTE 1 The term "electrical equipment" is used to mean ME EQUIPMENT or other electrical equipment. This technical report also uses the term "equipment" to mean ME EQUIPMENT or other electrical or non-electrical equipment in the context of an ME SYSTEM.

NOTE 2 An index of defined terms used in this technical report is found beginning on page 27.

#### 3.1

##### CLINICAL ENGINEERING DEPARTMENT

entity accountable on behalf of the RESPONSIBLE ORGANIZATION for the safe and effective management of technology and the application of medical and biomedical engineering within the clinical environment.

NOTE Clinical engineering services can be provided by the health care facility or they can be obtained from outside.

### 4 Nature of HAZARDS

ME EQUIPMENT or ME SYSTEMS can introduce a number of HAZARDS for PATIENTS, OPERATORS or the surroundings (e.g. poisonous gases, overpressure, explosion, electrical shock). These can be caused by misapplication, faults in the equipment that might not be obvious, improper functioning, installation or environmental conditions.

PATIENTS can be exceptionally sensitive to HAZARDS because they are either unaware of them, unable to react normally (for example, if they are unconscious), or because the nature of their treatment makes them more susceptible.

Proper construction of the ME EQUIPMENT, ME SYSTEM or the installation alone do not always achieve the desired safety; the mode of use (application), environment, MAINTENANCE and training also need to be considered.

### 5 BASIC SAFETY provisions of and symbols on ME EQUIPMENT

#### 5.1 General

This clause contains a description of those BASIC SAFETY provisions of ME EQUIPMENT that need to be available to the OPERATOR in order to operate the ME EQUIPMENT properly. The OPERATOR should also know the meaning of all symbols marked on the ME EQUIPMENT. For the BASIC SAFETY provisions for ME SYSTEMS, see Clause 9.

#### 5.2 ACCOMPANYING DOCUMENTS



ME EQUIPMENT is provided with ACCOMPANYING DOCUMENTS, which are considered to be an essential part of the ME EQUIPMENT.

The ACCOMPANYING DOCUMENTS consist partly of instructions for use intended for the OPERATOR and partly of a technical description for the CLINICAL ENGINEERING DEPARTMENT. The two parts can be provided in separate volumes.

The instructions for use contain all the information necessary to operate the ME EQUIPMENT and ensure its correct functioning. The instructions for use should be easily accessible to the OPERATOR. Whenever possible, the instructions for use should remain with the ME EQUIPMENT.

Short instructions for use (in the form of a label or a sheet) should be fixed to the ME EQUIPMENT if its use is not obvious or if it represents special HAZARDS to the PATIENT. A copy of such short instructions should be incorporated in the instructions for use.

NOTE Prior to the publication of IEC 60601-1:2005, the symbol  was used in the IEC 60601 series of standards to mean "Attention, consult accompanying documents". In IEC 60601-1:2005, that symbol is used to indicate caution, which aligns with its common usage outside the ME EQUIPMENT sector. IEC 60601-1:2005 added a

symbol  to indicate, "follow operating instructions". Additionally, a new safety sign  has been added to mark ME EQUIPMENT where failure to follow operating instructions could place the PATIENT or OPERATOR at RISK.

### 5.3 Colours of indicator lights

A description of the colours used for indicator lights is given in Table 1.

**Table 1 – Colours of indicator lights and their meaning for ME EQUIPMENT**



Colour	Meaning
Red	Warning – immediate response by the OPERATOR is required
Yellow	Caution – prompt response by the OPERATOR is required
Green	Ready for use
Any other colour	Meaning other than that of red, yellow or green

Dot-matrix and other alphanumeric displays are not considered to be indicator lights unless they are used to simulate alarm indicator lights. See Table 3 for a description of the colours used for alarm indicator lights.

### 5.4 Markings on ME EQUIPMENT

Warnings, marking of controls, and other symbols are explained in the instructions for use. Additional markings provide help to identify each piece of ME EQUIPMENT for REPAIR and MAINTENANCE purposes (see also note in 5.2).

When markings are used to convey a warning, prohibition or mandatory action that mitigates a RISK that is not obvious to the OPERATOR, the MANUFACTURER should use a safety sign selected from ISO 7010. When a safety sign is not available, the MANUFACTURER can use:

- the general warning sign  along with an affirmative statement describing the principal RISK(S) foreseen (e.g. "May cause burns", "Risk of explosion");
- the general prohibition sign  along with a statement describing what is prohibited (e.g. "Do not open", "Do not drop"); or
- the general mandatory action sign  along with text describing the required action (e.g. "Wear protective gloves", "Scrub before entering").

### 5.5 Protection against electric shock

#### 5.5.1 Method of protection for ME EQUIPMENT

In order to protect the PATIENT, the OPERATOR and other persons against the danger of electric shock, ME EQUIPMENT is constructed according to the following classes:



- a) CLASS I ME EQUIPMENT (PROTECTIVELY EARTHED)  
 The BASIC SAFETY of CLASS I ME EQUIPMENT is ensured by BASIC INSULATION and by being PROTECTIVELY EARTHED.
- b) CLASS II ME EQUIPMENT (with DOUBLE INSULATION)  
 The BASIC SAFETY of CLASS II ME EQUIPMENT is ensured by DOUBLE or REINFORCED INSULATION. CLASS II ME EQUIPMENT can be identified by the symbol .
- c) INTERNALLY POWERED ME EQUIPMENT  
 INTERNALLY POWERED ME EQUIPMENT gets the power necessary for its operation from an INTERNAL ELECTRICAL POWER SOURCE, such as a battery.  
  
 INTERNALLY POWERED ME EQUIPMENT usually has no connection to a SUPPLY MAINS. However, INTERNALLY POWERED ME EQUIPMENT that has a means of connection to a SUPPLY MAINS is required to be CLASS I or CLASS II while connected to the SUPPLY MAINS (e.g. to recharge batteries).

NOTE Electrical equipment not belonging to these classes should not be used for medical purposes.

**5.5.2 Degree of protection of APPLIED PARTS**

The APPLIED PARTS of the ME EQUIPMENT are further classified according to the degree of protection they provide against electrical shock. The different types are: TYPE B, TYPE BF, and TYPE CF APPLIED PARTS. The degree of protection is indicated by the symbols in Figure 1 marked adjacent to or on the connector for the APPLIED PART.



**Figure 1 – Symbols indicating the degree of protection provided by an APPLIED PART**

If there is no connector, then the symbol should appear on the APPLIED PART.

Only TYPE CF APPLIED PARTS are suitable to be used in DIRECT CARDIAC APPLICATIONS.

EXAMPLE A catheter that comes into direct contact with the heart muscle during an ablation procedure.

APPLIED PARTS can be protected against the effects of a discharge of a cardiac defibrillator. These APPLIED PARTS can be recognized by the symbols in Figure 2.

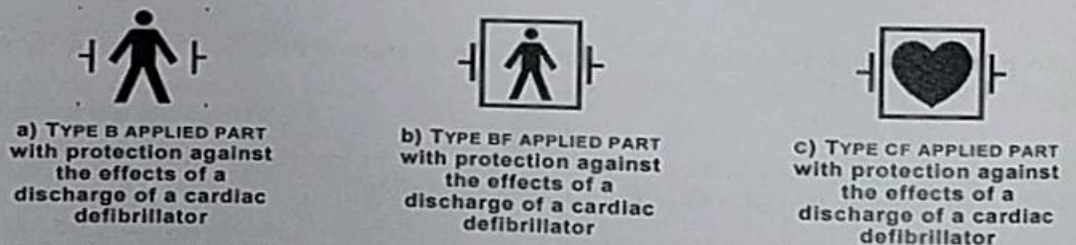

**Figure 2 – Symbols indicating the degree of protection against the effects of a discharge of a cardiac defibrillator**

### 5.5.3 ME EQUIPMENT not properly marked

If the degree of protection provided by the APPLIED PARTS has not been marked on the ME EQUIPMENT or stated in the instructions for use (e.g. older ME EQUIPMENT), such ME EQUIPMENT is to be checked by the CLINICAL ENGINEERING DEPARTMENT to determine whether it is suitable for use in the PATIENT ENVIRONMENT, and marked accordingly.

NOTE 1 See a description of the PATIENT ENVIRONMENT in Annex A.

NOTE 2 Do not connect ME EQUIPMENT to the PATIENT, especially in combination with other electrical equipment, if it is not marked with an appropriate degree of protection of the APPLIED PARTS.

## 5.6 Protection against mechanical HAZARDS

### 5.6.1 Protection of PATIENTS, OPERATORS and others from suspended or moving masses

ME EQUIPMENT should not be allowed to expose the PATIENT, OPERATOR, or other persons to a MECHANICAL HAZARD, especially if it contains suspended or moving masses or automatic controls, e.g. X-ray equipment, operating tables, etc. The OPERATOR should regularly check the functioning of ALARM SYSTEMS and other safety devices as set out in the instructions for use.

If the ME EQUIPMENT or ME SYSTEM is equipped with an emergency stopping device, the actuator will be coloured red and will be distinct from other controls. If the actuator interrupts mechanical movement, then it is marked on or adjacent to the face of the actuator with the

word "STOP" or the symbol .

### 5.6.2 Stability

ME EQUIPMENT or a combination of equipment should not be made unstable during NORMAL USE or during transport (e.g. inappropriate stacking).

ME EQUIPMENT or an ME SYSTEM that might tip over while being moved from one place to another will be identified by either a warning notice on the ME EQUIPMENT itself or within the instructions for use.

ME EQUIPMENT that presents a substantial RISK of tipping over as the result of a PATIENT, OPERATOR or other person pushing, sitting or stepping on the ME EQUIPMENT will either be permanently marked with a warning or one of the safety signs in Figure 3.



				
No pushing		No sitting		No stepping on surface

Figure 3 – Safety signs indicating a RISK from a person pushing, sitting or stepping on ME EQUIPMENT

### 5.6.3 Protection against rough handling

If ME EQUIPMENT or an ME SYSTEM is dropped, or subjected to a fall or to other extremely rough handling, it should be checked by the CLINICAL ENGINEERING DEPARTMENT in order to ensure it is operating correctly and all means for reducing RISKS are intact.

IS 11478 : 2018

IEC/TR 60930 : 2008

## 6 Protection against thermal HAZARDS and fire prevention

### 6.1 APPLIED PARTS not intended to supply heat to the PATIENT

The maximum skin contact temperature of an APPLIED PART not intended to supply heat to the patient can exceed 41 °C. The OPERATOR should check the instructions for use or consult with the CLINICAL ENGINEERING DEPARTMENT to determine if an APPLIED PART can exceed the 41 °C limit.

NOTE IEC 60601-1:2005 allows the maximum skin contact temperature of an APPLIED PART to exceed 41 °C based on the type of material used in the APPLIED PART, the duration of contact with healthy skin, and the area of skin of an adult in contact with the hot surface. If the APPLIED PART can exceed 41 °C, the MANUFACTURER is required to disclose the maximum temperature in the instructions for use.<sup>1)</sup>

### 6.2 Protection against ignition in medical locations

A RISK of fire or explosion can exist in rooms where flammable anaesthetic, cleaning or disinfection agents are used, since they can form explosive mixtures with air, oxygen or nitrous oxide. Usually the RISK of fire is small because of good ventilation of the room. Some electrical equipment is designed to operate in environments where the RISK of ignition can not be mitigated by measures such as ventilation that keeps the concentration of such agents below the ignition threshold. Such electrical equipment will be marked with one of the symbols in Figure 4.



a) Category AP  
Equipment designed to  
avoid ignition of  
FLAMMABLE ANAESTHETIC  
MIXTURE WITH AIR



b) Category APG  
Equipment designed to  
avoid ignition of  
FLAMMABLE ANAESTHETIC  
MIXTURE WITH OXYGEN OR  
NITROUS OXIDE

Figure 4 – Symbols indicating the ME EQUIPMENT is designed to avoid ignition of FLAMMABLE ANAESTHETIC MIXTURE WITH AIR, OR FLAMMABLE ANAESTHETIC MIXTURE WITH OXYGEN OR NITROUS OXIDE

In case of doubt, the CLINICAL ENGINEERING DEPARTMENT should be consulted.

## 7 Protection against unwanted or excessive radiation

In this context, radiation includes ionizing radiation (e.g. X-ray, alpha, beta, gamma, neutron, and other particle radiation), non-ionizing radiation (e.g. electromagnetic, infrared, visible light, ultraviolet and microwave) and acoustic energy. When radiation is used for diagnostic or therapeutic purposes, precautions should be taken in accordance with local laws and health care facility procedures. Medical physicists should be consulted concerning radiation protection and relevant laws and regulations.

## 8 ALARM SYSTEMS

### 8.1 General

ALARM SIGNALS are used:

<sup>1)</sup> The human contact temperatures in IEC 60601-1:2005 were based on clinical expertise, clinical literature, published standards and experimentation. For additional information, see EN 563, *Safety of machinery – Temperature of touchable surfaces – Ergonomic data to establish temperature limit values for hot surfaces*, and SCHWARTZ, SI., SHIRES, GT., SPENCER, FC., STORER, EH., *Principles of Surgery*, 7<sup>th</sup> Ed., McGraw-Hill, Inc., ISBN 0-07-054256-2.

- to indicate unsatisfactory physiological PATIENT states;
- to indicate unsatisfactory functional states of the ME EQUIPMENT or ME SYSTEM or the installation; or
- to warn the OPERATOR of HAZARDS to the PATIENT or OPERATOR due to the ME EQUIPMENT or ME SYSTEM.

INFORMATION SIGNALS convey information that is independent of an ALARM CONDITION.

The following information about the ALARM SYSTEM is provided in the instructions for use:

- an overview of the ALARM SYSTEM, including a listing and description of every possible ALARM CONDITION and, when appropriate for the intended OPERATOR, a summary of how it is determined;
- an indication of any delay inherent in the determination of an ALARM CONDITION; and
- instructions on how and when to verify the functionality of the ALARM SYSTEM.

When translating the MANUFACTURER'S instructions for use or when writing the health care facilities' own instructions for an ALARM SYSTEM, it is important to use a stringent terminology to avoid misunderstandings. Wording corresponding to the defined terms should be used to describe the state of the ALARM SYSTEM (e.g. ALARM OFF, ALARM PAUSED, AUDIO OFF, and AUDIO PAUSED). The following terms should not be used to describe the state of the ALARM SYSTEM: Silence, Silence/Reset, Pre-Silence, Mute, Suspend, Disable, Inhibit, Prevent, Pause, or Off. For example, the OPERATOR needs to clearly understand the difference between inactivating the generation of an auditory ALARM SIGNAL (AUDIO OFF) and inactivating the generation of all ALARM SIGNALS (ALARM OFF).

For the safety of the PATIENT, it is very important that the medical staff understand how the ALARM SYSTEMS are configured and work for different pieces of ME EQUIPMENT. A single piece of ME EQUIPMENT can have multiple MANUFACTURER-configured ALARM PRESETS. An ALARM PRESET is a set of stored configuration parameters that affect the performance of the ALARM SYSTEM. The ME EQUIPMENT can also have multiple RESPONSIBLE ORGANIZATION- and OPERATOR-configured ALARM PRESETS that the OPERATOR can choose from.

The configuration of the ALARM SYSTEM should be approved by the head of department or a responsible physician.

## 8.2 ALARM CONDITION priorities

The MANUFACTURER assigns each ALARM CONDITION to one or more of the following priorities: HIGH PRIORITY, MEDIUM PRIORITY, or LOW PRIORITY based on Table 2. The standards for particular ME EQUIPMENT can specify the priority for a specific ALARM CONDITION. Each ALARM CONDITION and its associated priority is described in the instructions for use.

Table 2 – ALARM CONDITION priorities from IEC 60601-1-8:2006

Potential result of failure to respond to the cause of ALARM CONDITION	Onset of potential HARM <sup>a</sup>		
	Immediate <sup>b</sup>	Prompt <sup>c</sup>	Delayed <sup>d</sup>
Death or Irreversible injury	HIGH PRIORITY <sup>e</sup>	HIGH PRIORITY	MEDIUM PRIORITY
Reversible injury	HIGH PRIORITY	MEDIUM PRIORITY	LOW PRIORITY
Minor injury or discomfort	MEDIUM PRIORITY	LOW PRIORITY	LOW PRIORITY or NO ALARM SIGNAL

An INFORMATION SIGNAL may also be used to indicate the potential for delayed minor injury or discomfort.

<sup>a</sup> Onset of potential HARM refers to when an injury occurs and not to when it is manifested.  
<sup>b</sup> Having the potential for the event to develop within a period of time not usually sufficient for manual corrective action.  
<sup>c</sup> Having the potential for the event to develop within a period of time usually sufficient for manual corrective action.  
<sup>d</sup> Having the potential for the event to develop within an unspecified time greater than that given under "prompt".  
<sup>e</sup> Where practicable, ME EQUIPMENT with a therapeutic function should incorporate automatic safety mechanisms to prevent immediate death or irreversible injury caused by the ME EQUIPMENT.

### 8.3 Visual ALARM SIGNALS

For each ALARM CONDITION, an ALARM SYSTEM is required to generate visual ALARM SIGNALS to indicate the presence of ALARM CONDITIONS and their priority. These can be in the form of an alarm indicator light or a graphical simulation of an indicator light. The visual ALARM SIGNAL should comply with the colour and flashing requirements given in Table 3.

Table 3 – Characteristics of alarm indicator lights from IEC 60601-1-8:2006

Alarm priority	Indicator colour	Flashing frequency	Duty cycle
HIGH PRIORITY	Red	1,4 Hz to 2,8 Hz	20 % to 60 % on
MEDIUM PRIORITY	Yellow	0,4 Hz to 0,8 Hz	20 % to 60 % on
LOW PRIORITY	Cyan or yellow	Constant (on)	100 % on

Dot matrix or other alphanumeric displays are not considered to be an alarm indicator light unless those displays are used to simulate an alarm indicator light.

### 8.4 Auditory ALARM SIGNALS

In addition to visual ALARM SIGNALS, an ALARM SYSTEM can provide one or more sets of auditory ALARM SIGNALS. If auditory ALARM SIGNALS are provided, then the following apply:

- auditory ALARM SIGNALS are to be priority encoded;
- HIGH PRIORITY auditory ALARM SIGNALS of a particular set of ALARM SIGNALS should convey a higher level of urgency than the MEDIUM or LOW PRIORITY ALARM SIGNALS and INFORMATION SIGNALS of that ALARM SIGNAL set;
- MEDIUM PRIORITY auditory ALARM SIGNALS of a particular set of ALARM SIGNALS should convey a higher level of urgency than the LOW PRIORITY ALARM SIGNALS and INFORMATION SIGNALS of that ALARM SIGNAL set.

## 9 BASIC SAFETY provisions for ME SYSTEMS

### 9.1 General

An ME SYSTEM is a combination of items of equipment, at least one of which is ME EQUIPMENT. An ME SYSTEM is created when the various pieces of equipment are inter-connected by

FUNCTIONAL CONNECTIONS or by use of a MULTIPLE SOCKET-OUTLET (MSO). Inside the PATIENT ENVIRONMENT the ME SYSTEM should provide a level of BASIC SAFETY equivalent to ME EQUIPMENT. Outside the PATIENT ENVIRONMENT the ME SYSTEM should provide a level of BASIC SAFETY equivalent to equipment complying with the relevant safety standards applicable to that equipment.

## 9.2 ACCOMPANYING DOCUMENTS

An ME SYSTEM is provided with ACCOMPANYING DOCUMENTS, which are considered to be an essential part of the ME SYSTEM. The ACCOMPANYING DOCUMENTS should include the ACCOMPANYING DOCUMENTS for each item of ME EQUIPMENT (see 5.2) as well as each item of non-ME-EQUIPMENT provided by the MANUFACTURER of the ME SYSTEM.

The ME SYSTEM'S ACCOMPANYING DOCUMENTS will describe which parts of the ME SYSTEM are suitable for use within the PATIENT ENVIRONMENT.

## 9.3 PATIENT ENVIRONMENT

As the non-ME EQUIPMENT elements of an ME SYSTEM might not provide the same level of protection for the PATIENT as the ME EQUIPMENT, the OPERATOR should take special care when introducing equipment into the PATIENT ENVIRONMENT to prevent:

- placing the non-ME EQUIPMENT elements where they can be touched by the PATIENT; and
- touching the PATIENT and the non-ME EQUIPMENT at the same time.

NOTE See a description of the PATIENT ENVIRONMENT in Annex A.

## 9.4 MULTIPLE SOCKET-OUTLET (MSO)

ME EQUIPMENT or an ME SYSTEM can incorporate a MULTIPLE SOCKET-OUTLET (MSO). In order to protect the PATIENT, OPERATOR or others against the danger of electric shock, the MSO should be designed so that:

- connection to the MSO can only be made using a TOOL, or
- the MSO can only accept non-standard MAINS PLUGS, or
- the MSO is supplied via a separating transformer.

Figure 5 shows an example of the construction of a simple MSO where the individual socket-outlets are accessible only with the use of a tool.



The MSO should be marked with the general warning sign and:

- the maximum allowed continuous output in amperes or volt-amperes; or
- the equipment or equipment parts that can be safely attached.

The OPERATOR should only connect the equipment or equipment parts marked on the MSO. The OPERATOR should consult with the CLINICAL ENGINEERING DEPARTMENT before connecting new equipment to an MSO.

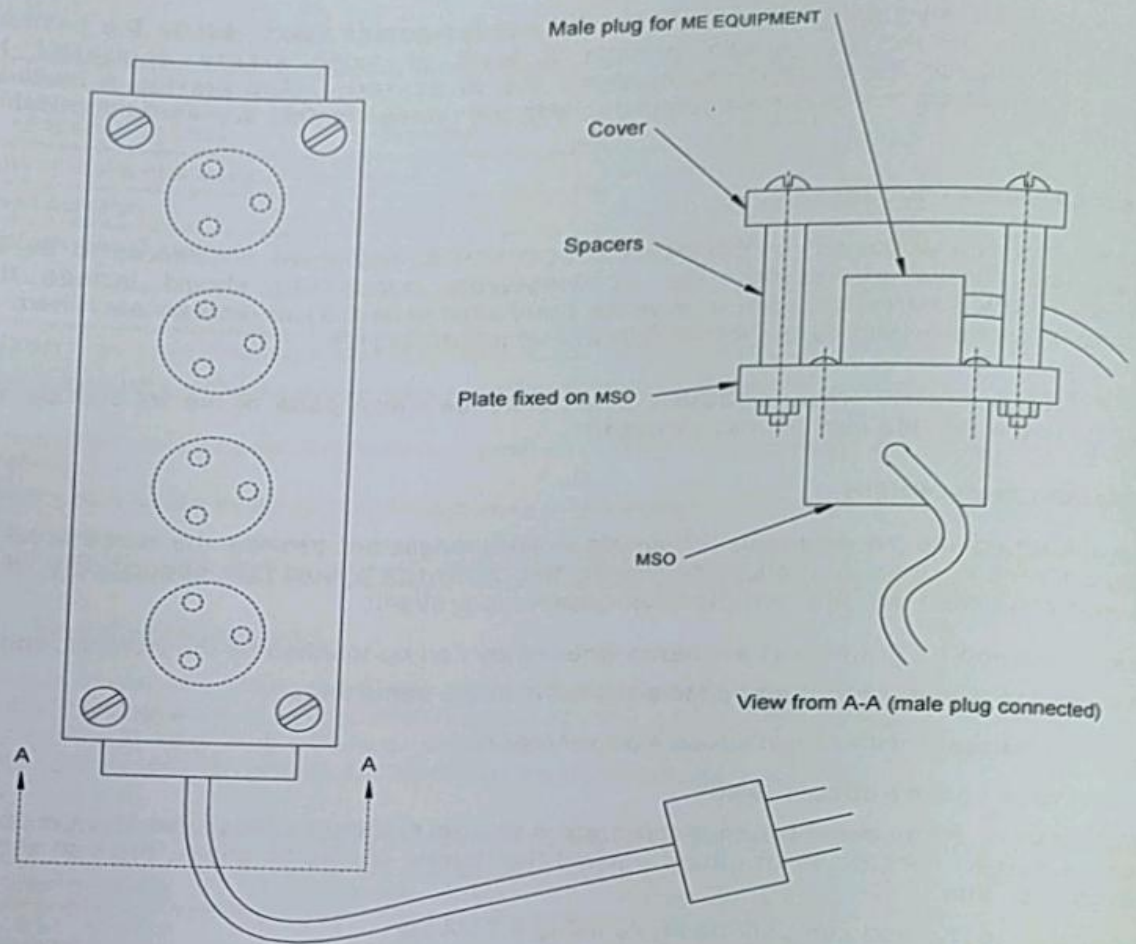

Figure 5 – Example of the construction of a MULTIPLE SOCKET-OUTLET (MSO)

### 10 Protection against ingress of water or particulate matter

The ENCLOSURES of some ME EQUIPMENT, ME SYSTEMS and their parts (e.g. foot-operated control devices) are designed to provide protection against the harmful ingress of water or particulate matter. When a specific degree of protection is provided, the ENCLOSURE will be marked with a code consisting of the letters "IP" followed by two characters. The first character describes the degree of protection against ingress of particulate matter. The second character specifies the degree of protection against ingress of water. The absence of an "IP" marking on an ENCLOSURE indicates that there is no specific degree of protection against ingress of water or particulate matter provided. The character "X" in either position indicates that a requirement is not specified. For example, the marking "IPX1" indicates that there is no rating for protection against ingress of particulate matter.

ENCLOSURES that are intended to be used where liquids are present might require some degree of protection against the ingress of water.

EXAMPLE 1 Foot-operated control devices of ME EQUIPMENT are classified at least IPX1 (protected against vertically falling water drops).

EXAMPLE 2 Foot-operated control devices of ME EQUIPMENT intended to be used in areas such as emergency rooms and operating theatres might be classified as IPX6 (protected against powerful water jets).

The OPERATOR should consult with the CLINICAL ENGINEERING DEPARTMENT about the appropriate "IP" classification of the equipment to be used in each medical location.

## 11 Cleaning, disinfection and sterilization

ME EQUIPMENT, ME SYSTEMS and their parts, including APPLIED PARTS and ACCESSORIES, can become contaminated through contact with the PATIENT or with body fluids or expired gases. These devices will need to be cleaned and disinfected or sterilized. Applying methods or materials for cleaning, disinfection or sterilizing other than those types specified by the MANUFACTURER in the instructions for use could damage the device. This damage could result in increased RISKS to the PATIENT, OPERATOR or others.

The OPERATOR should consult the instructions for use or the CLINICAL ENGINEERING DEPARTMENT to exclude unsuitable methods and materials for cleaning, disinfection or sterilizing ME EQUIPMENT, ME SYSTEMS or their parts.

## 12 Electromagnetic phenomena

### 12.1 General recommendations

Some ME EQUIPMENT and ME SYSTEMS are susceptible to ELECTROMAGNETIC DISTURBANCES, generated by other ME EQUIPMENT or ME SYSTEMS or by other electrical equipment operating in the vicinity. These ELECTROMAGNETIC DISTURBANCES can either be carried on the SUPPLY MAINS or by radiation. Examples of ME EQUIPMENT or ME SYSTEMS that are often the most susceptible to ELECTROMAGNETIC DISTURBANCES include measuring equipment for low-amplitude signals such as ECG and EEG equipment and wireless patient-monitoring (telemetry) systems.

Potential sources of ELECTROMAGNETIC DISTURBANCE can include mobile phones, radio communication equipment, and faulty/malfunctioning building infrastructure systems (elevator control systems, ventilation control systems, electronic access control systems, etc.). Other ME EQUIPMENT, such as high-frequency surgical equipment, can also be a source of ELECTROMAGNETIC DISTURBANCE.

Problems due to ELECTROMAGNETIC DISTURBANCES are often difficult to detect, so it is important that the OPERATOR has a basic knowledge of the phenomena. For example, the medical and nursing staff should be able to recognize that problems with a piece of ME EQUIPMENT or an ME SYSTEM could be the result of an ELECTROMAGNETIC DISTURBANCE caused by a mobile phone that is too close to the electrical equipment.

Examples of how ELECTROMAGNETIC DISTURBANCES could affect ME EQUIPMENT include:

- an infusion pump that stops working and gives an ALARM SIGNAL;
- a mechanical ventilator that stops operating, loses its operating settings and gives an ALARM SIGNAL;
- an ECG machine that displays excessive interference on the electrocardiogram output;
- an external defibrillator that generates interference noise on its loudspeaker.

The OPERATOR should consult the CLINICAL ENGINEERING DEPARTMENT as soon as interference from an ELECTROMAGNETIC DISTURBANCE is suspected. The CLINICAL ENGINEERING DEPARTMENT should develop the capability to detect and "record" new sources of ELECTROMAGNETIC DISTURBANCE, such as wireless Ethernet or navigational aids on aircraft used for medical transportation.

The RESPONSIBLE ORGANIZATION has to manage the ELECTROMAGNETIC ENVIRONMENT of use to permit ME EQUIPMENT and ME SYSTEMS to perform as intended without disturbing other ME EQUIPMENT, ME SYSTEMS or other electrical equipment.



IS 11478 : 2018

IEC/TR 60930 : 2008

It is important that OPERATORS, RESPONSIBLE ORGANIZATIONS and CLINICAL ENGINEERING DEPARTMENTS read the instructions for use and the technical descriptions and take appropriate actions based on the information from the MANUFACTURERS.

## 12.2 Identification, marking and documents

### 12.2.1 Marking on the outside of ME EQUIPMENT or ME EQUIPMENT parts

ME EQUIPMENT or ME SYSTEMS that include RADIO FREQUENCY (RF) transmitters or that intentionally apply RF energy for diagnosis or treatment should be marked with the symbol



Some ME EQUIPMENT or ME SYSTEMS might be marked with the symbol  adjacent to a connector.

This warning symbol means that accessible pins of connectors are susceptible to ELECTROSTATIC DISCHARGES (ESD). The OPERATOR needs to be made aware that accessible pins of connectors identified with the ESD warning symbol should not be touched with the fingers or with a HAND-HELD TOOL unless proper precautionary procedures have been followed.

Precautionary procedures should include:

- methods to prevent build-up of electrostatic charge (e.g. air conditioning, humidification, conductive floor coverings, non-synthetic clothing);
- discharging one's body to the frame of the ME EQUIPMENT or ME SYSTEM or to earth or a large metal object; and
- bonding oneself by means of a wrist strap to the ME EQUIPMENT or ME SYSTEM or to earth.

### 12.2.2 ACCOMPANYING DOCUMENTS

#### 12.2.2.1 Instructions for use

The instructions for use should include the following:

- a) a statement that ME EQUIPMENT needs special precautions regarding ELECTROMAGNETIC COMPATIBILITY (EMC) and needs to be installed and PUT INTO SERVICE according to the EMC information provided in the ACCOMPANYING DOCUMENTS; and
- b) a statement that portable and mobile RF communications equipment can affect the ME EQUIPMENT.

Some ME EQUIPMENT and ME SYSTEMS intended for use in domestic establishments or connection to the public mains network might include the following warning or equivalent:

#### **Warning**

This equipment/system is intended for use by healthcare professionals only. This equipment/system may cause radio interference or may disrupt the operation of nearby equipment. It may be necessary to take mitigation measures, such as re-orienting or relocating the equipment/system or shielding the location.

In such a case, the MANUFACTURER or CLINICAL ENGINEERING DEPARTMENT should be consulted.

Such a warning should be included for several groups of ME EQUIPMENT that can emit more ELECTROMAGNETIC DISTURBANCES than normally is allowed in domestic establishments. This can be the case for the following types of ME EQUIPMENT:

- magnetic resonance imaging equipment;

- diathermy ME EQUIPMENT (short wave, ultra-short wave, microwave therapy ME EQUIPMENT);
- high frequency surgical ME EQUIPMENT.

For example, physiotherapists generally have offices in domestic establishments. Without this allowance, such ME EQUIPMENT would only be recommended for use in shielded rooms or in hospitals, with the result that many patients would go without treatment or would have to wait a longer period of time to receive treatment.

#### 12.2.2.2 Technical description

The technical description should include the following:

- a) a list of all cables (including their maximum lengths when applicable), transducers and other ACCESSORIES that need to be used for the ME EQUIPMENT or ME SYSTEM to comply with the EMC requirements specified in IEC 60601-1-2:2007;
- b) a warning that use of other ACCESSORIES, transducers or cables could result in increased EMISSIONS or decreased IMMUNITY;
- c) a series of tables intended for the CLINICAL ENGINEERING DEPARTMENT to assist them in defining the appropriate ELECTROMAGNETIC ENVIRONMENT for the ME EQUIPMENT or ME SYSTEM.

### 13 Electrical installations in medical locations

BASIC SAFETY during application of ME EQUIPMENT or ME SYSTEMS does not only depend on the ME EQUIPMENT or ME SYSTEM, but also on the safety provisions of the installation. For reasons outlined in Clause 4 the requirements for electrical installations in medical locations are more stringent than in homes and offices.

NOTE Refer to local wiring regulations for medical locations.

### 14 Purchasing and MAINTENANCE of equipment, training of personnel

#### 14.1 Accountability

The RESPONSIBLE ORGANIZATION is the entity accountable for the use and MAINTENANCE of ME EQUIPMENT and ME SYSTEMS. The RESPONSIBLE ORGANIZATION can delegate responsibility for certain activities to others, such as the CLINICAL ENGINEERING DEPARTMENT. However, the RESPONSIBLE ORGANIZATION is ultimately accountable for the safe use and handling of the ME EQUIPMENT or the ME SYSTEM.

#### 14.2 Purchasing

The following questions should be considered and discussed with the potential supplier and the CLINICAL ENGINEERING DEPARTMENT before new ME EQUIPMENT or a new ME SYSTEM is ordered:

- Does the ME EQUIPMENT or ME SYSTEM comply with the relevant standards and requirements?
- Is the performance adequate for the intended application?
- Is the new ME EQUIPMENT or ME SYSTEM compatible with the existing installations and equipment?
- Are the contents of the ACCOMPANYING DOCUMENTS in accordance with 5.2 and, if applicable, 9.2?
- Is the ME EQUIPMENT marked as described in 5.3 and 5.4?
- Does the ME EQUIPMENT have an ALARM SYSTEM and:
  - is the ALARM SYSTEM configurable?

- does the ALARM SYSTEM provide security to prevent unauthorized changes to the ALARM SYSTEM configuration?
- Is training available for OPERATORS and clinical engineers?
- Are MAINTENANCE facilities available?
- Have MAINTENANCE costs been considered?
- Has the MANUFACTURER disclosed an EXPECTED SERVICE LIFE for the ME EQUIPMENT or ME SYSTEM in the ACCOMPANYING DOCUMENTS or in other ways, e.g. by correspondence?
- Do external factors and ACCESSORIES (e.g. disposables) influence:
  - the electrical and/or functional safety?
  - the EXPECTED SERVICE LIFE?
- Are there instructions on how to assess and maintain the OPERATOR'S competence to use and maintain the ME EQUIPMENT or ME SYSTEM?

### 14.3 Delivery and commissioning

Before a new piece of ME EQUIPMENT or a new ME SYSTEM is PUT INTO SERVICE, the RESPONSIBLE ORGANIZATION should verify that the requirements in the purchasing agreement have been met with regard to product delivery, ACCOMPANYING DOCUMENTS, educational materials, ACCESSORIES, spare parts, etc. Before the warranty begins, the RESPONSIBLE ORGANIZATION should verify the product's markings and general performance are suitable for use.

Before the ME EQUIPMENT or ME SYSTEM is released for clinical use, the CLINICAL ENGINEERING DEPARTMENT should verify that it has been installed at the assigned location and that any necessary measures have been taken in accordance with the MANUFACTURER'S instructions.

OPERATORS should check that the health care facilities' own written instructions have been approved by the head of department or a responsible physician.

The CLINICAL ENGINEERING DEPARTMENT should also ensure that a logbook or other mechanism is available to the medical and nursing staff for documenting the use and MAINTENANCE of the ME EQUIPMENT or ME SYSTEM, and for recording any incidents or near-incidents involving the ME EQUIPMENT or ME SYSTEM.

### 14.4 Training

The medical and nursing staff and the CLINICAL ENGINEERING DEPARTMENT should be trained to:

- use the ME EQUIPMENT or ME SYSTEM in the way the MANUFACTURER has intended, and
- perform the routine SERVICING needed in order to minimize breakdowns.

It is the duty of the RESPONSIBLE ORGANIZATION to maintain an adequate level of expertise by training staff members. The MANUFACTURER should do at least one of the following:

- provide the materials necessary for training;
- ensure that the materials necessary for training are available; or
- provide the training.

The training schedule must be considered when purchasing ME EQUIPMENT or an ME SYSTEM. Preferably, the dates for training should be fixed before the ME EQUIPMENT or ME SYSTEM is delivered. The staff needs to acquire sufficient skills before the ME EQUIPMENT or ME SYSTEM is ready for clinical use.

## 14.5 MAINTENANCE

### 14.5.1 Concepts

MAINTENANCE includes preventive MAINTENANCE and fault REPAIR. Preventative MAINTENANCE includes:

- SERVICING undertaken by the OPERATOR in the sequence and intervals indicated in the instructions for use, and
- periodic MAINTENANCE performed by:
  - the CLINICAL ENGINEERING DEPARTMENT,
  - by an outside MAINTENANCE firm preferably approved by the MANUFACTURER, or
  - by the MANUFACTURER himself or his agent.

Periodic MAINTENANCE consists of:

- the replacement of parts that wear during use, thus minimizing interruption caused by failures of the ME EQUIPMENT or ME SYSTEM,
- tests to check the BASIC SAFETY and performance of the ME EQUIPMENT or ME SYSTEM, and
- adjustments, if necessary.

The use of the ME EQUIPMENT or ME SYSTEM should be planned so as to allow for the specified MAINTENANCE procedures (including any calibration).

### 14.5.2 MAINTENANCE programme

The reason for SERVICING the ME EQUIPMENT or an ME SYSTEM is to maintain its safety and performance in such a way that:

- the ME EQUIPMENT or ME SYSTEM functions as intended by its MANUFACTURER,
- the ME EQUIPMENT or ME SYSTEM is safe for the PATIENT and for the OPERATOR, and
- the interruptions of use are minimized.

Generally there are no universally applicable measures or structure for a MAINTENANCE program. However, according to the ACCOMPANYING DOCUMENTS, the following guidelines should be followed.

- The OPERATOR should perform checks before use (e.g. cleaning and replacement of materials consumed).
- The OPERATOR should be trained to recognize HAZARDOUS SITUATIONS and these should be reported.
- The CLINICAL ENGINEERING DEPARTMENT should perform, or request the MANUFACTURER or his agent to perform, the MAINTENANCE of the ME EQUIPMENT or ME SYSTEM.
- A periodic MAINTENANCE programme should be established and recorded for most ME EQUIPMENT and ME SYSTEMS (namely that for which the BASIC SAFETY and ESSENTIAL PERFORMANCE requirements are severe).

When there are no instructions for the MAINTENANCE of the ME EQUIPMENT or ME SYSTEM available from the MANUFACTURER, the following should be done regularly:

- a) visual INSPECTION;
- b) checking the PROTECTIVE EARTH CONDUCTOR;
- c) assessment of the equipment by OPERATORS and the CLINICAL ENGINEERING DEPARTMENT;
- d) verification that the responsible organization has prepared a document containing the necessary instructions for use and that these instructions are up to date, especially with regard to the checks described in a) through c).

IS 11478 : 2018

IEC/TR 60930 : 2008

The IEC has developed a standard, IEC 62353, that applies to testing of ME EQUIPMENT or ME SYSTEMS or their parts:

- before they are PUT INTO SERVICE;
- during routine MAINTENANCE, INSPECTION and SERVICING, and after REPAIR; or
- during RECURRENT TESTS

to assess the safety of the ME EQUIPMENT, ME SYSTEM or their parts. IEC 62353 is intended to assist the CLINICAL ENGINEERING DEPARTMENT by establishing uniform tests for ME EQUIPMENT from different MANUFACTURERS.

#### 14.6 Checking of the installation and selection of the ME EQUIPMENT or ME SYSTEM

##### 14.6.1 Installation

Once the medical staff has decided which medical procedures are to be performed in an existing medical location, the CLINICAL ENGINEERING DEPARTMENT should check if the installation meets the safety requirements for such a location.

If a new department is to be set up, a consultation of the interested parties should be conducted at a very early stage of the planning.

##### 14.6.2 Verification of equipment safety

Once the installation has been checked, the CLINICAL ENGINEERING DEPARTMENT should verify that the ME EQUIPMENT and ME SYSTEMS to be deployed in the medical location are compatible with the installation, in order to maintain the BASIC SAFETY of the PATIENT and the OPERATOR.

##### 14.6.3 Single items of ME EQUIPMENT

If only one item of ME EQUIPMENT is used at a time, BASIC SAFETY depends on using ME EQUIPMENT that has a degree of protection, as indicated (by the symbols) in 5.5.2, appropriate to the medical procedure or as required in applicable IEC standards.

##### 14.6.4 Combinations of ME EQUIPMENT

When two or more items of ME EQUIPMENT are used simultaneously to perform a specific medical procedure on the same PATIENT, the combination of ME EQUIPMENT can represent an additional electrical HAZARD. Therefore the CLINICAL ENGINEERING DEPARTMENT should be consulted when such combinations are planned.

##### 14.6.5 Connection of ME EQUIPMENT or an ME SYSTEM to the health care facilities' data network

Connection of ME EQUIPMENT or an ME SYSTEM to the health care facilities' data network can result in previously unidentified RISKS to PATIENTS, OPERATORS or others. Those RISKS could arise because of

- the effect the health care facilities' data network could have on the ME EQUIPMENT or ME SYSTEM, such as disruption of time-critical applications or processes; or
- the effect the ME EQUIPMENT or ME SYSTEM could have on the health care facilities' data network, such as overloading the network's data transfer capability, thus depriving other network users of needed services.

The OPERATOR should check in the instructions for use to determine if the ME EQUIPMENT or ME SYSTEM is intended to be connected to a data network. Any connection to the health care facilities' data network should be done by, or approved by, the CLINICAL ENGINEERING DEPARTMENT and whoever is responsible for designing the integrated system, i.e. the health care facilities' system integrator.

## 15 Recommended practice

The following points should always be remembered when using ME EQUIPMENT or ME SYSTEMS:

- a) Be sure that the ME EQUIPMENT or ME SYSTEM has been accepted for use by the CLINICAL ENGINEERING DEPARTMENT.
- b) First read the instructions for use.
- c) Follow the instructions for use when setting up and calibrating equipment.
- d) Check the functioning of ALARM SYSTEMS and other safety devices following the instructions for use.
- e) Check whether consumable parts are available.
- f) Avoid the use of extension cords and multiple adaptors; insist that enough socket outlets are installed.
- g) Never pull the plug by the cord.
- h) Have damaged socket outlets, plugs, and cords replaced.
- i) Have the ME EQUIPMENT, the ME SYSTEM or their parts checked if they have been subjected to undue mechanical stress, e.g. fall and impact.
- j) Do not put liquids or infusion bags on any ENCLOSURES.
- k) Have the ENCLOSURES, and, if necessary, the interior of the equipment checked if accidental entry of liquid is suspected.
- l) When sterilizing or disinfecting the ME EQUIPMENT, the ME SYSTEM or their parts, be sure the procedure will not damage it.
- m) Do not impair ventilation.
- n) Avoid direct sunlight to prevent overheating.
- o) If stacking ME EQUIPMENT, take care to ensure adequate ventilation and stability.
- p) Where oxygen is in use, be aware that the fire HAZARD is increased.
- q) Make sure that ME EQUIPMENT used in the vicinity of flammable anaesthetic, cleaning or disinfection agents that can form explosive mixtures with air, oxygen or nitrous oxide are appropriately rated (see 6.2).
- r) Only connect approved equipment or equipment parts to a MULTIPLE SOCKET-OUTLET associated with an ME SYSTEM.
- s) Be careful that non-ME EQUIPMENT elements of an ME SYSTEM are not brought into the PATIENT ENVIRONMENT where they might be touched by:
  - the PATIENT, or
  - the OPERATOR while simultaneously touching the PATIENT,unless the CLINICAL ENGINEERING DEPARTMENT has determined that the entire ME SYSTEM is suitable to be in the PATIENT ENVIRONMENT.
- t) Connect ME EQUIPMENT or ME SYSTEMS to the health care facilities' data network only if approved by the CLINICAL ENGINEERING DEPARTMENT.
- u) Check that mains-operated household equipment (hair dryers, shavers, radios, TV sets) is not connected to ME EQUIPMENT, or to a vacant socket outlet intended for ME EQUIPMENT. Such household equipment can create a HAZARDOUS SITUATION for a PATIENT connected to the ME EQUIPMENT or for other PATIENTS when such equipment is connected to a vacant socket outlet intended for ME EQUIPMENT.
- v) Confirm that the health care facilities' instructions describe the measures to be taken in case of a power failure and these instructions are available.
- w) Check the function of the ME EQUIPMENT or ME SYSTEM according to the MANUFACTURER'S instruction for use before use or before delivery to a PATIENT.
- x) If applicable, check that the ALARM SYSTEM is configured as intended and is functioning as expected before use.

**IS 11478 : 2018**

**IEC/TR 60930 : 2008**

- y) Follow the instructions for assessing and maintaining the OPERATOR'S competence to use and maintain the ME EQUIPMENT or ME SYSTEM.
- z) If in doubt, ask the CLINICAL ENGINEERING DEPARTMENT.

## Annex A (informative)

### PATIENT ENVIRONMENT

The PATIENT ENVIRONMENT is defined in IEC 60601-1:2005 as any volume in which intentional or unintentional contact can occur between a PATIENT and parts of the ME EQUIPMENT or ME SYSTEM or between a PATIENT and other persons touching parts of the ME EQUIPMENT or ME SYSTEM. It is difficult to define precisely the dimensions for the volume in which diagnosis, monitoring or treatment occurs. The dimensions for the PATIENT ENVIRONMENT given in Figure A.1 have been justified in practice.

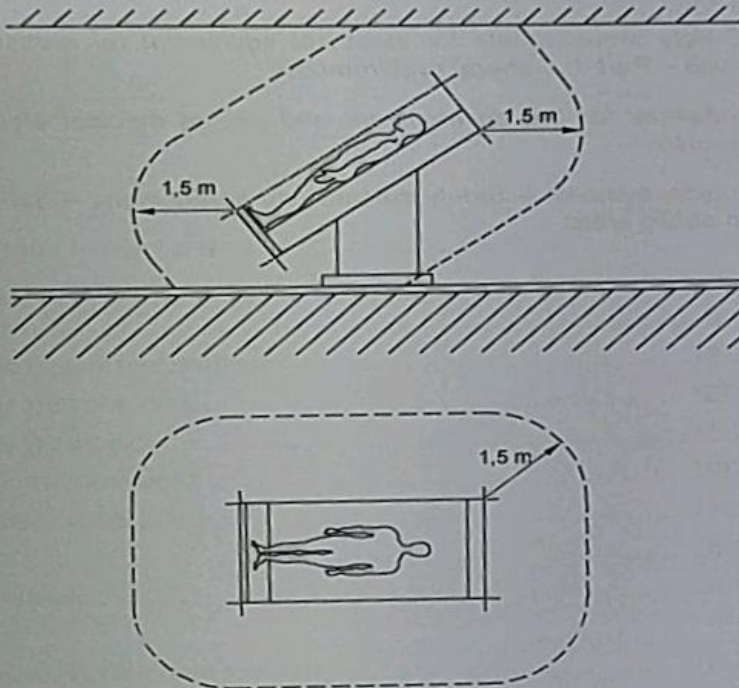

NOTE The dimensions in the figure show minimum extent of the PATIENT ENVIRONMENT in a free surrounding.

Figure A.1 – Example of PATIENT ENVIRONMENT



IS 11478 : 2018

IEC/TR 60930 : 2008

### Bibliography

- [1] IEC 60364-7-710, *Electrical installations of buildings – Part 7-710: Requirements for special installations or locations – Medical locations*
- [2] IEC 60513:1994, *Fundamental aspects of safety standards for medical electrical equipment*
- [3] IEC 60601 (all parts), *Medical electrical equipment*
- [4] IEC 60788, *Medical electrical equipment – Glossary of defined terms*
- [5] IEC 60878, *Graphical symbols for electrical equipment in medical practice*
- [6] IEC 60950-1, *Information technology equipment – Safety – Part 1: General requirements*
- [7] IEC 61010-1, *Safety requirements for electrical equipment for measurement, control, and laboratory use – Part 1: General requirements*
- [8] IEC 61258, *Guidelines for the development and use of medical electrical equipment educational materials*
- [9] ISO 7010, *Graphical symbols – Safety colours and safety signs – Safety signs used in workplaces and public areas*

## Index of defined terms used in this technical report

ACCESSORY.....	IEC 60601-1:2005, 3.3
ACCOMPANYING DOCUMENT .....	IEC 60601-1:2005, 3.4
ALARM CONDITION .....	IEC 60601-1-8:2006, 3.1
ALARM OFF .....	IEC 60601-1-8:2006, 3.4
ALARM PAUSED .....	IEC 60601-1-8:2006, 3.5
ALARM PRESET .....	IEC 60601-1-8:2006, 3.6
ALARM SIGNAL .....	IEC 60601-1-8:2006, 3.9
ALARM SYSTEM .....	IEC 60601-1-8:2006, 3.11
APPLIED PART.....	IEC 60601-1:2005, 3.8
AUDIO OFF.....	IEC 60601-1-8:2006, 3.12
AUDIO PAUSED.....	IEC 60601-1-8:2006, 3.13
BASIC INSULATION .....	IEC 60601-1:2005, 3.9
BASIC SAFETY.....	IEC 60601-1:2005, 3.10
CLASS I.....	IEC 60601-1:2005, 3.13
CLASS II .....	IEC 60601-1:2005, 3.14
CLINICAL ENGINEERING DEPARTMENT .....	3.1
DIRECT CARDIAC APPLICATION .....	IEC 606-1-1:2005, 3.22
DOUBLE INSULATION .....	IEC 60601-1:2005, 3.23
ELECTROMAGNETIC COMPATIBILITY (EMC).....	IEC 60601-1-2:2007, 3.4
ELECTROMAGNETIC DISTURBANCE.....	IEC 60601-1-2:2007, 3.5
(ELECTROMAGNETIC) EMISSION .....	IEC 60601-1-2:2007, 3.6
ELECTROMAGNETIC ENVIRONMENT.....	IEC 60601-1-2:2007, 3.7
ELECTROSTATIC DISCHARGE (ESD).....	IEC 60601-1-2:2007, 3.9
ENCLOSURE.....	IEC 60601-1:2005, 3.26
ESSENTIAL PERFORMANCE .....	IEC 60601-1:2005, 3.27
EXPECTED SERVICE LIFE .....	IEC 60601-1:2006, 3.28
FLAMMABLE ANAESTHETIC MIXTURE WITH AIR .....	IEC 60601-1:2005, 3.31
FLAMMABLE ANAESTHETIC MIXTURE WITH OXYGEN OR NITROUS OXIDE .....	IEC 60601-1:2005, 3.32
FUNCTIONAL CONNECTION.....	IEC 60601-1:2005, 3.33
HAND-HELD .....	IEC 60601-1:2005, 3.37
HARM.....	IEC 60601-1:2005, 3.38
HAZARD .....	IEC 60601-1:2005, 3.39
HAZARDOUS SITUATION.....	IEC 60601-1:2005, 3.40
HIGH PRIORITY .....	IEC 60601-1-8:2006, 3.22
IMMUNITY (to a disturbance) .....	IEC 60601-1-2:2007, 3.13
INFORMATION SIGNAL .....	IEC 60601-1-8:2006, 3.23
INTENDED USE .....	IEC 60601-1:2005, 3.44
INTERNAL ELECTRICAL POWER SOURCE .....	IEC 60601-1:2005, 3.45
INTERNALLY POWERED.....	IEC 60601-1:2005, 3.46
INSPECTION.....	IEC 62353:2007, 3.14
LOW PRIORITY.....	IEC 60601-1-8:2006, 3.27
MAINS PLUG.....	IEC 60601-1:2005, 3.50

IS 11478 : 2018

IEC/TR 60930 : 2008

MAINTENANCE.....	IEC 62353:2007, 3.19
MANUFACTURER.....	IEC 60601-1:2005, 3.55
MECHANICAL HAZARD.....	IEC 60601-1:2005, 3.61
ME EQUIPMENT.....	IEC 60601-1:2005, 3.63
ME SYSTEM.....	IEC 60601-1:2005, 3.64
MEDIUM PRIORITY.....	IEC 60601-1-8:2006, 3.28
MULTIPLE SOCKET-OUTLET (MSO).....	IEC 60601-1:2005, 3.67
NORMAL USE.....	IEC 60601-1:2005, 3.71
OPERATOR.....	IEC 60601-1:2005, 3.73
PATIENT.....	IEC 60601-1:2005, 3.76
PATIENT ENVIRONMENT.....	IEC 60601-1:2005, 3.79
PROTECTIVE EARTH CONDUCTOR.....	IEC 60601-1:2005, 3.93
PROTECTIVELY EARTHED.....	IEC 60601-1:2005, 3.96
PUTTING INTO SERVICE.....	IEC 62353:2007, 3.32
RADIO FREQUENCY (RF).....	IEC 60601-1-2:2007, 3.25
RECURRENT TEST.....	IEC 62353:2007, 3.33
REINFORCED INSULATION.....	IEC 60601-1:2005, 3.99
REPAIR.....	IEC 62353:2007, 3.35
RESPONSIBLE ORGANIZATION.....	IEC 60601-1:2005, 3.101
RISK.....	IEC 60601-1:2005, 3.102
RISK CONTROL.....	IEC 60601-1:2005, 3.105
SERVICING.....	IEC 62353:2007, 3.37
SUPPLY MAINS.....	IEC 60601-1:2005, 3.120
TOOL.....	IEC 60601-1:2005, 3.127
TYPE B APPLIED PART.....	IEC 60601-1:2005, 3.132
TYPE BF APPLIED PART.....	IEC 60601-1:2005, 3.133
TYPE CF APPLIED PART.....	IEC 60601-1:2005, 3.134

## Bureau of Indian Standards

BIS is a statutory institution established under the *Bureau of Indian Standards Act, 2016* to promote harmonious development of the activities of standardization, marking and quality certification of goods and attending to connected matters in the country.

## Copyright

BIS has the copyright of all its publications. No part of these publications may be reproduced in any form without the prior permission in writing of BIS. This does not preclude the free use, in course of implementing the standard, of necessary details, such as symbols and sizes, type or grade designations. Enquiries relating to copyright be addressed to the Director (Publications), BIS.

## Review of Indian Standards

Amendments are issued to standards as the need arises on the basis of comments. Standards are also reviewed periodically; a standard along with amendments is reaffirmed when such review indicates that no changes are needed; if the review indicates that changes are needed, it is taken up for revision. Users of Indian Standards should ascertain that they are in possession of the latest amendments or edition by referring to the latest issue of 'BIS Catalogue' and 'Standards: Monthly Additions'.

This Indian Standard has been developed from Doc No.: MHD 15 (0458).

### Amendments Issued Since Publication

Amendment No.	Date of Issue	Text Affected

## BUREAU OF INDIAN STANDARDS

### Headquarters:

Manak Bhavan, 9 Bahadur Shah Zafar Marg, New Delhi 110002

Telephones: 2323 0131, 2323 3375, 2323 9402

Website: www.bis.gov.in

### Regional Offices:

	Telephones
Central : Manak Bhavan, 9 Bahadur Shah Zafar Marg NEW DELHI 110002	{ 2323 7617 2323 3841
Eastern : 1/14, C.I.T. Scheme VII M, V.I.P. Road, Kankurgachi KOLKATA 700054	{ 2337 8499, 2337 8561 2337 8626, 2337 9120
Northern : Plot No. 4-A, Sector 27-B, Madhya Marg, CHANDIGARH 160019	{ 26 50206 265 0290
Southern : C.I.T. Campus, IV Cross Road, CHENNAI 600113	{ 2254 1216, 2254 1442 2254 2519, 2254 2315
Western : Manakalaya, E9 MIDC, Marol, Andheri (East) MUMBAI 400093	{ 2832 9295, 2832 7858 2832 7891, 2832 7892

**Branches:** AHMEDABAD. BENGALURU. BHOPAL. BHUBANESWAR. COIMBATORE.  
DEHRADUN. DURGAPUR. FARIDABAD. GHAZIABAD. GUWAHATI.  
HYDERABAD. JAIPUR. JAMMU. JAMSHEDPUR. KOCHI. LUCKNOW. NAGPUR.  
PARWANOO. PATNA. PUNE. RAIPUR. RAJKOT. VISAKHAPATNAM.

Published by BIS, New Delhi